



US00D701557S

(12) **United States Design Patent**  
**Lee et al.**

(10) **Patent No.:** **US D701,557 S**  
(45) **Date of Patent:** **\*\* Mar. 25, 2014**

(54) **GLASSES**

(71) Applicant: **Samsung Electronics Co., Ltd.**,  
Suwon-si (KR)  
(72) Inventors: **Se-O Lee**, Sungname-Si (KR); **Sang-II Park**, Namyangju-Si (KR); **Sang-Min Hyun**, Seoul (KR)  
(73) Assignee: **Samsung Electronics Co., Ltd.** (KR)  
(\*\*) Term: **14 Years**

(21) Appl. No.: **29/466,327**

(22) Filed: **Sep. 6, 2013**

(30) **Foreign Application Priority Data**

Mar. 8, 2013 (KR) ..... 30-2013-0011832

(51) **LOC (10) Cl.** ..... **16-06**

(52) **U.S. Cl.**  
USPC ..... **D16/309**

(58) **Field of Classification Search**  
USPC ..... D16/101, 300-342, 900; D29/109-110;  
351/41, 44, 51-52, 62, 158, 92,  
351/103-123, 140-153, 45-46; 2/426-432,  
2/447-449, 441, 434-437, 13, 15;  
D21/483, 659-661; D14/372

See application file for complete search history.

(56) **References Cited**

U.S. PATENT DOCUMENTS

D429,751 S *	8/2000	Garrity et al. ....	D16/309
D435,058 S *	12/2000	Green et al. ....	D16/309
D443,864 S *	6/2001	Obata .....	D14/126
D553,177 S *	10/2007	Chen .....	D16/326
D561,233 S *	2/2008	McLaughlin .....	D16/315
D565,082 S *	3/2008	McClure et al. ....	D16/309
D569,409 S *	5/2008	Lin .....	D16/301
D591,326 S *	4/2009	Travers et al. ....	D16/300
D611,980 S *	3/2010	Chen .....	D16/309
D664,184 S *	7/2012	Olsson et al. ....	D16/309
D680,152 S *	4/2013	Olsson et al. ....	D16/309
D685,018 S *	6/2013	Cho .....	D16/309
D685,019 S *	6/2013	Li .....	D16/309

\* cited by examiner

*Primary Examiner* — Raphael Barkai  
(74) *Attorney, Agent, or Firm* — Cantor Colburn LLP

(57) **CLAIM**

The ornamental design for glasses, as shown and described.

**DESCRIPTION**

FIG. 1 is a perspective view of glasses, showing our new design;  
FIG. 2 is a front view thereof;  
FIG. 3 is a rear view thereof;  
FIG. 4 is a side view thereof;  
FIG. 5 is another side view thereof;  
FIG. 6 is a top plan view thereof; and,  
FIG. 7 is a bottom plan view thereof.  
The broken lines are for environmental purpose only and form no part of the claimed design.  
The shade lines in the figures show contour and not surface ornamentation.

**1 Claim, 7 Drawing Sheets**

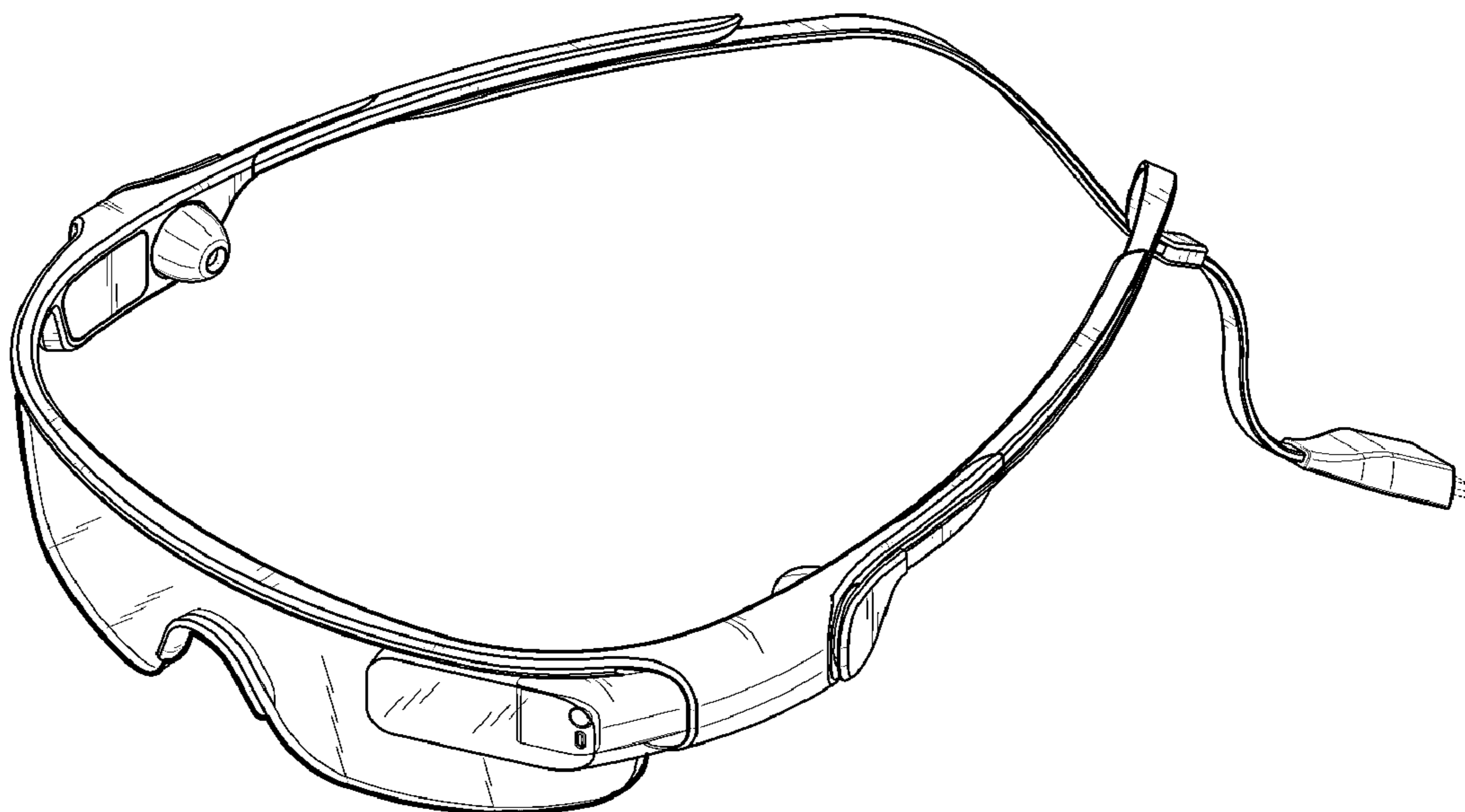

FIG. 1

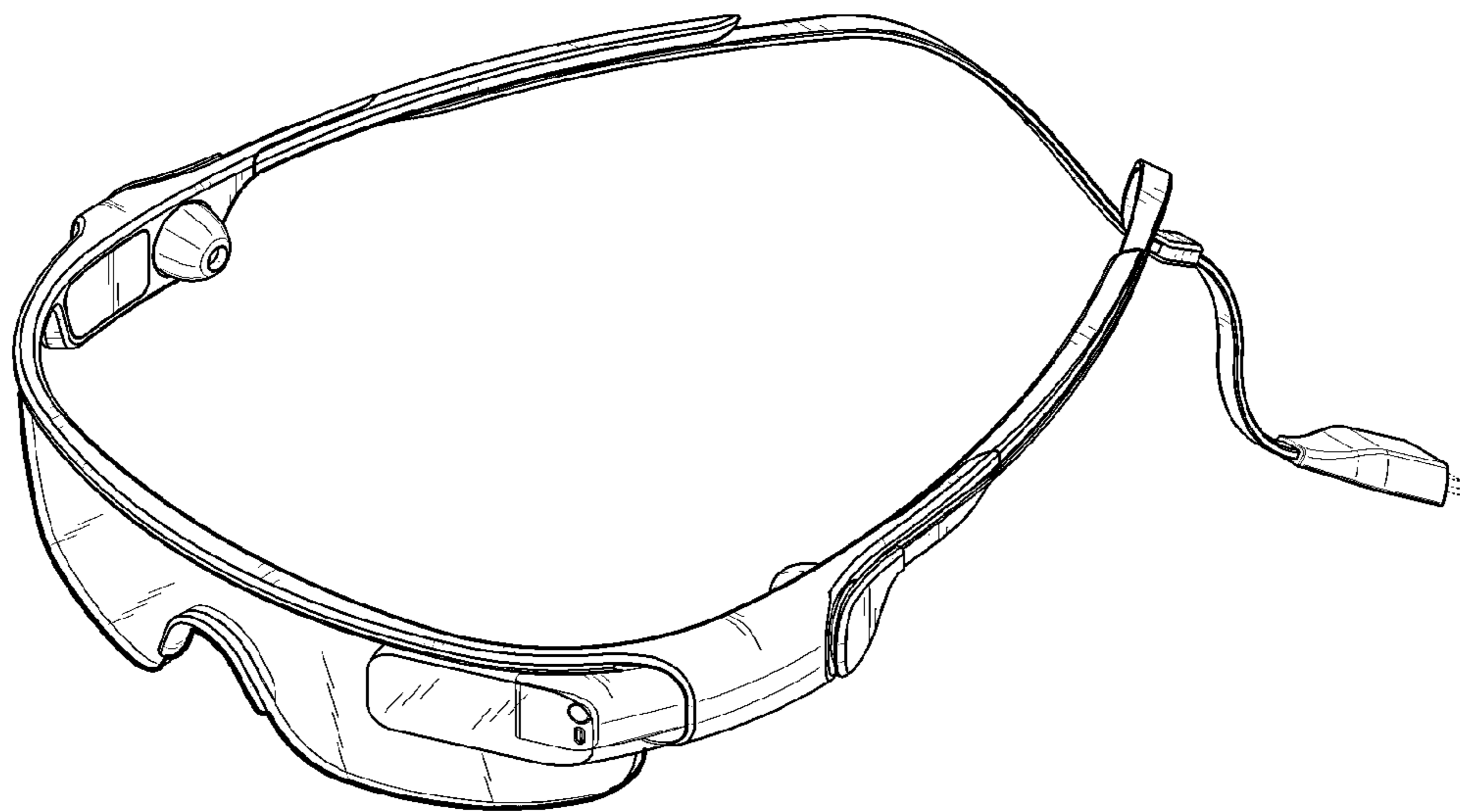

FIG. 2

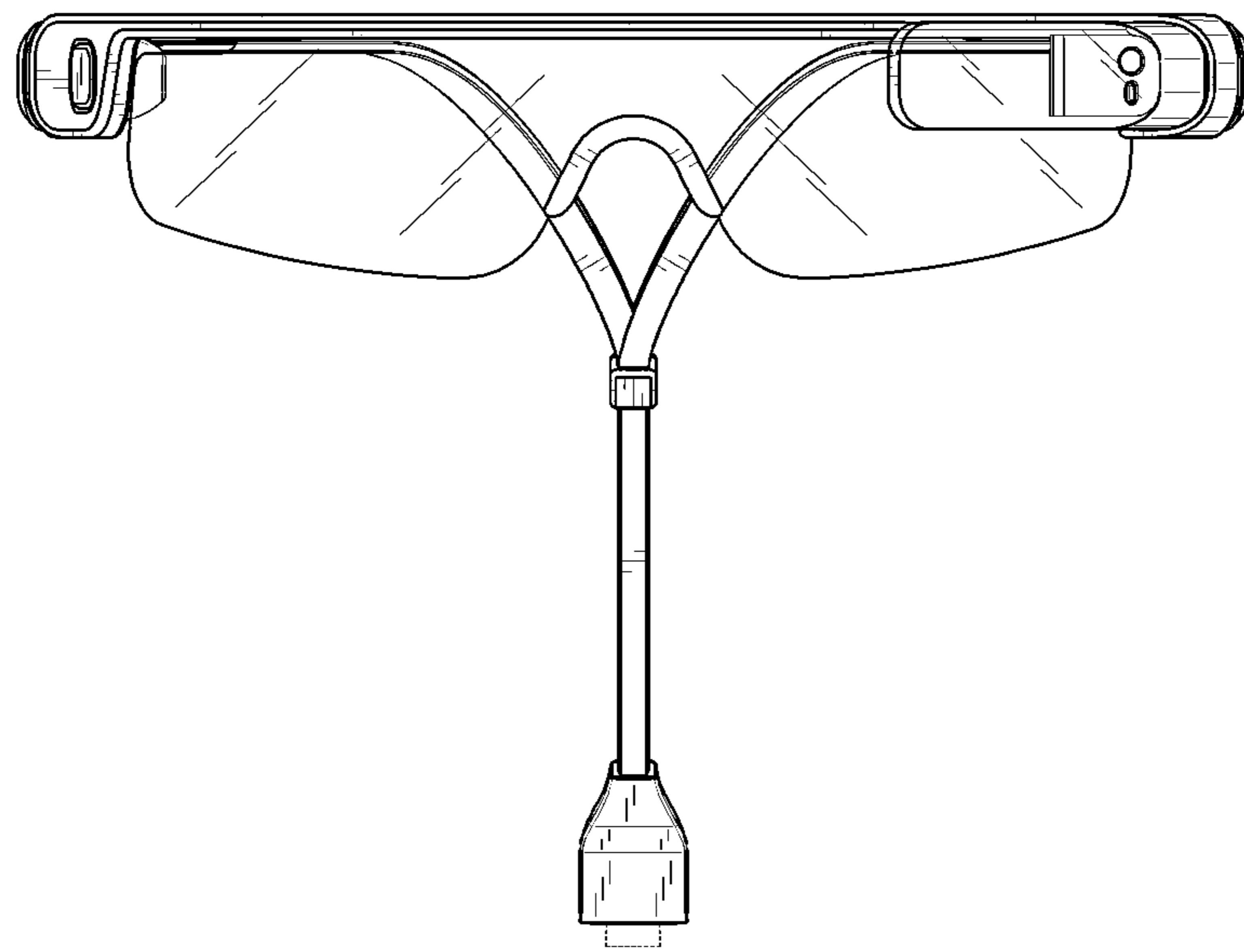

FIG. 3

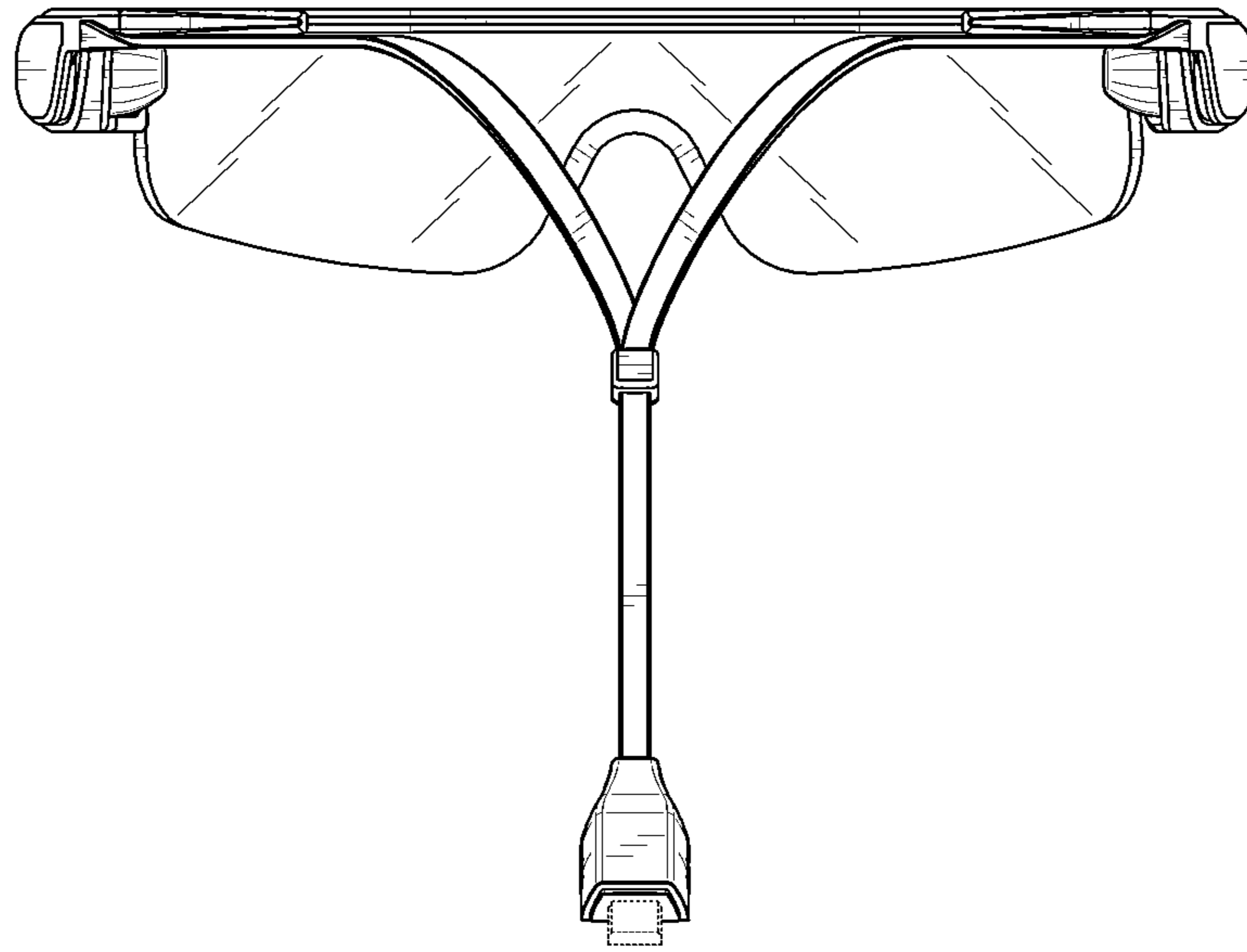

FIG. 4

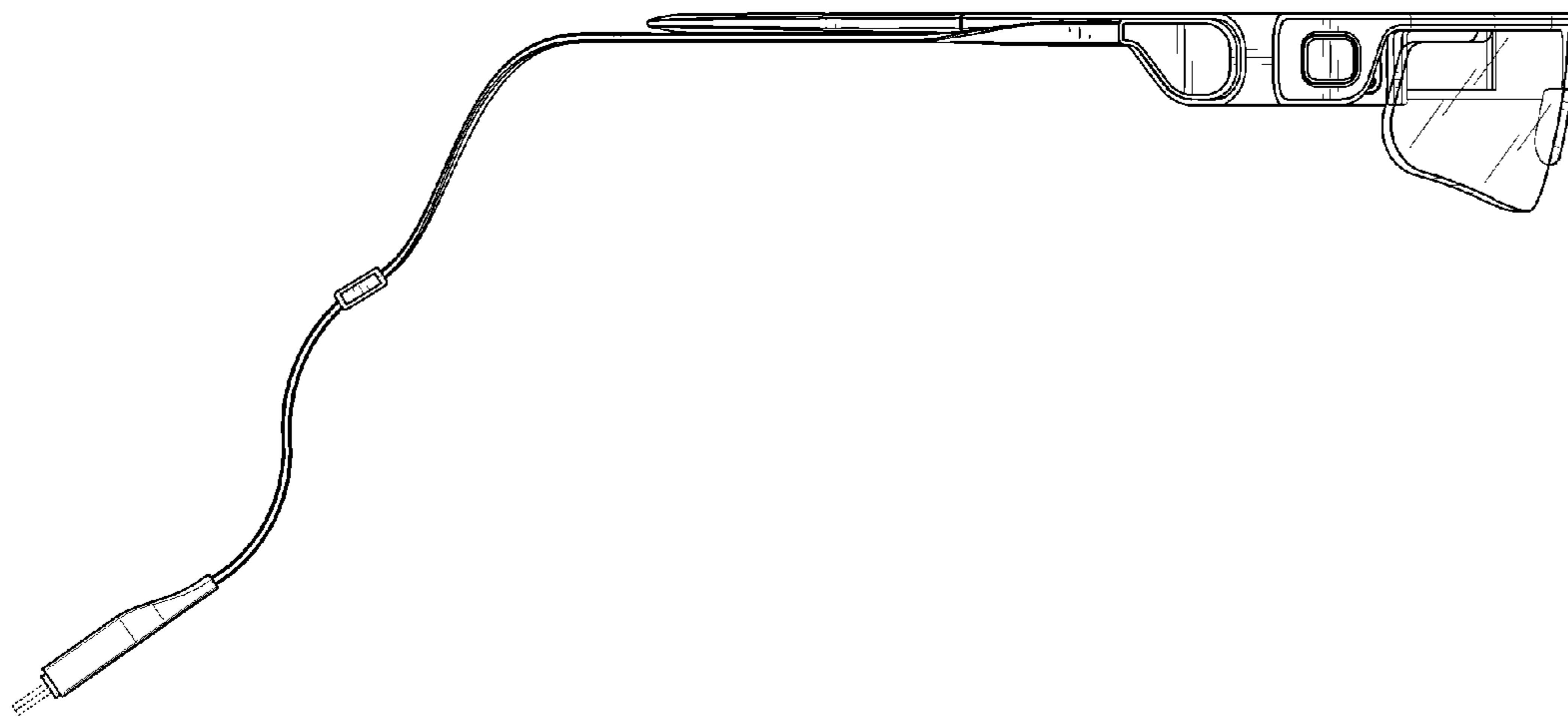

FIG. 5

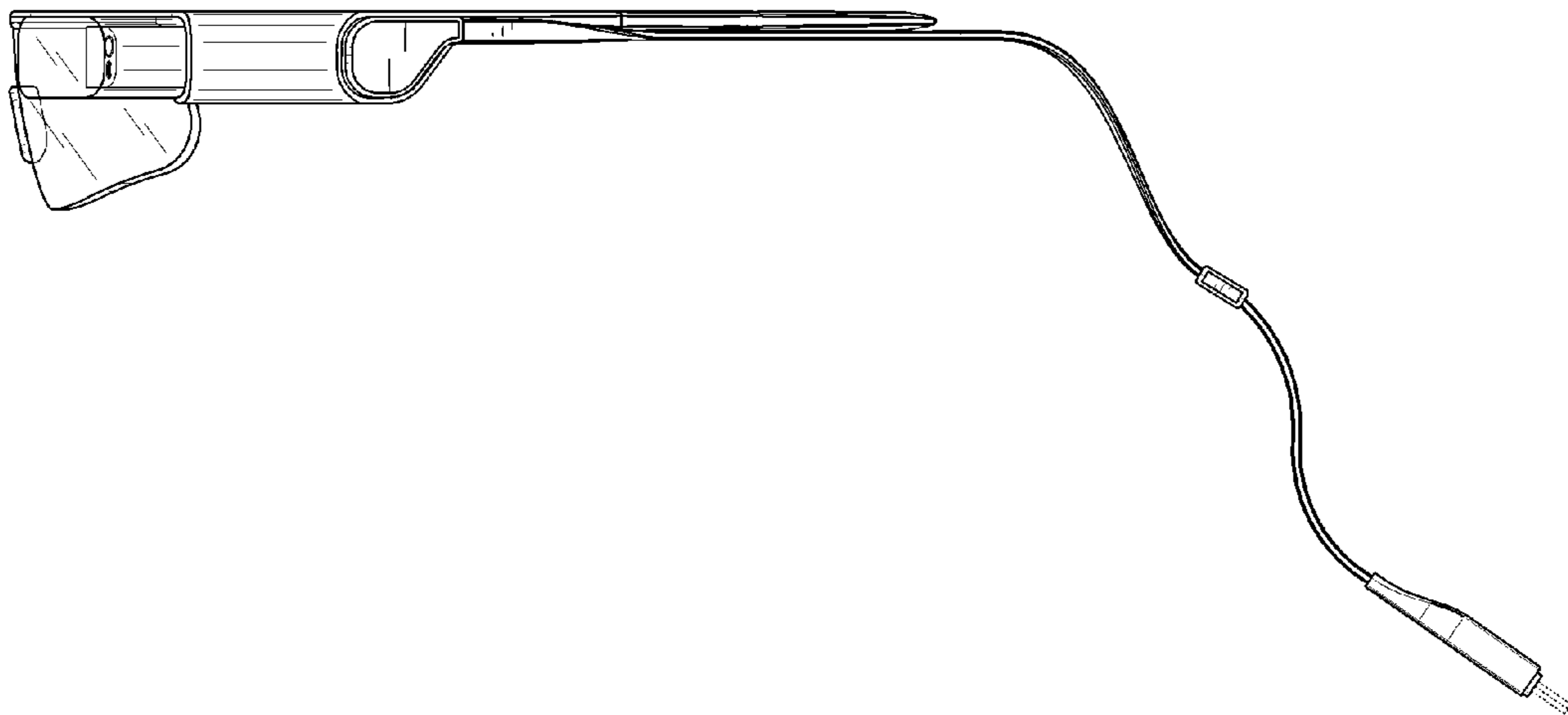

FIG. 6

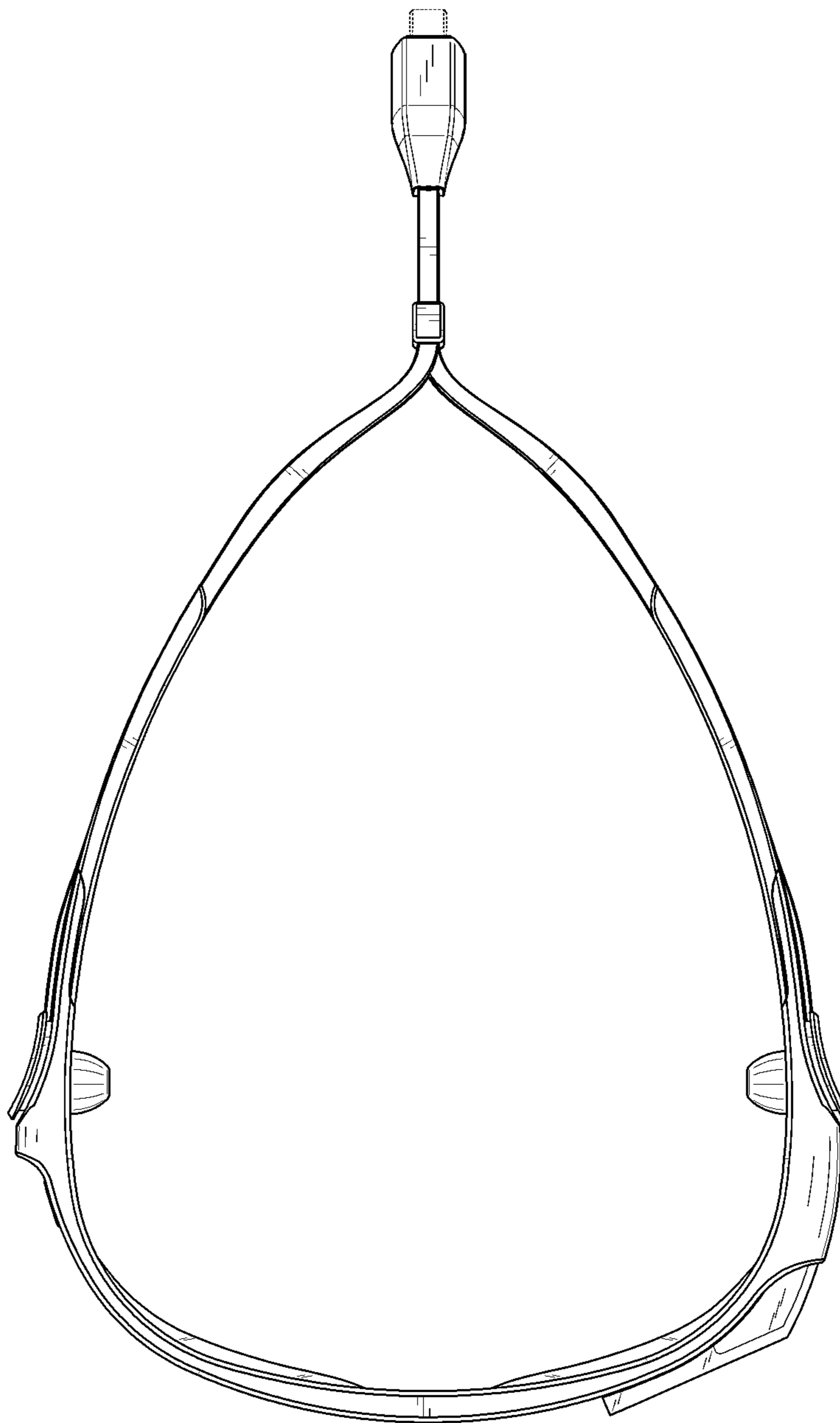

FIG. 7

