



US00D701302S

(12) **United States Design Patent**
Jeffery

(10) **Patent No.:** **US D701,302 S**
(45) **Date of Patent:** **** Mar. 18, 2014**

- (54) **VOICE TRAINING AID**
- (71) Applicant: **Lisa Cheryl Jeffery**, Miami, FL (US)
- (72) Inventor: **Lisa Cheryl Jeffery**, Miami, FL (US)
- (**) Term: **14 Years**
- (21) Appl. No.: **29/445,841**
- (22) Filed: **Feb. 18, 2013**
- (51) **LOC (10) Cl.** **24-01**
- (52) **U.S. Cl.**
USPC **D24/107**
- (58) **Field of Classification Search**
USPC D24/107, 151, 152, 173, 176; D11/157;
D21/532; 128/861; 434/185; 482/11;
600/23, 24
See application file for complete search history.

- D442,714 S * 5/2001 Warden D26/38
- 6,761,699 B2 * 7/2004 Chahine 601/135
- 7,214,064 B1 * 5/2007 Hall 434/185

* cited by examiner

Primary Examiner — Ian Simmons
Assistant Examiner — Richelle G Shelton
(74) *Attorney, Agent, or Firm* — Jeffrey Roddy

(57) **CLAIM**
The ornamental design for a voice training aid, as shown and described.

DESCRIPTION

FIG. 1 is a side view of my new design for a voice training aid; FIG. 2 is a side view thereof wherein (FIG. 1) has been rotated 90°; FIG. 3 is a end view thereof; FIG. 4 is a cross-sectional view taken along lines 4'-4' of (FIG. 1); FIG. 5 is a cross-sectional view taken along lines 4'-4' of (FIG. 2); FIG. 6 is a perspective view of my new design; and, FIG. 7 is a reduced size perspective view thereof. The broken line showing of a penny and a ribbon are included for the purpose of illustrating environment and forms no part of the claimed design.

- (56) **References Cited**
U.S. PATENT DOCUMENTS
625,879 A * 5/1899 Gardner 600/24
2,694,397 A * 11/1954 Herms 128/861
3,556,093 A * 1/1971 Quick 600/24
5,213,553 A * 5/1993 Light 482/11
D371,726 S * 7/1996 Strohlein D7/628
D377,098 S * 12/1996 Morimoto D24/175
D387,006 S * 12/1997 Benabe D11/157
5,735,772 A * 4/1998 Schiavoni 482/11

1 Claim, 3 Drawing Sheets

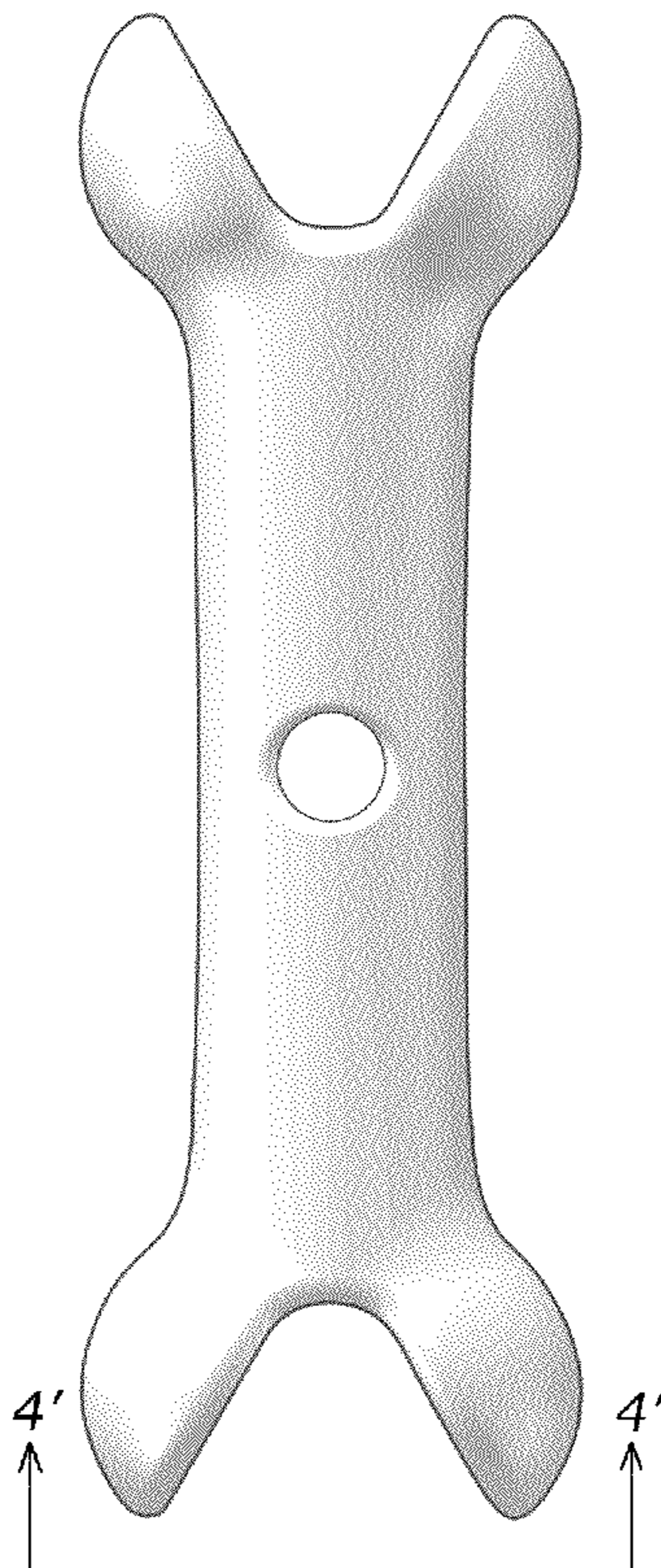

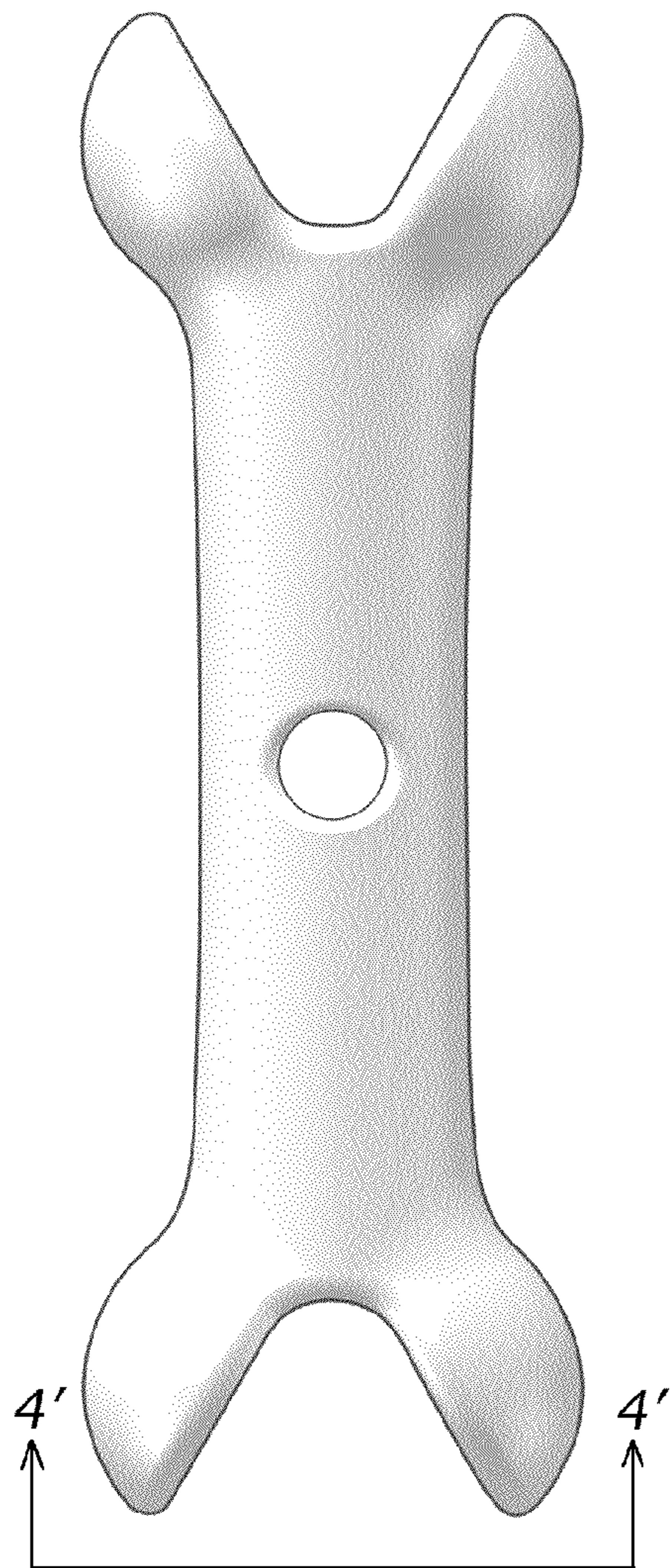

FIG. 1

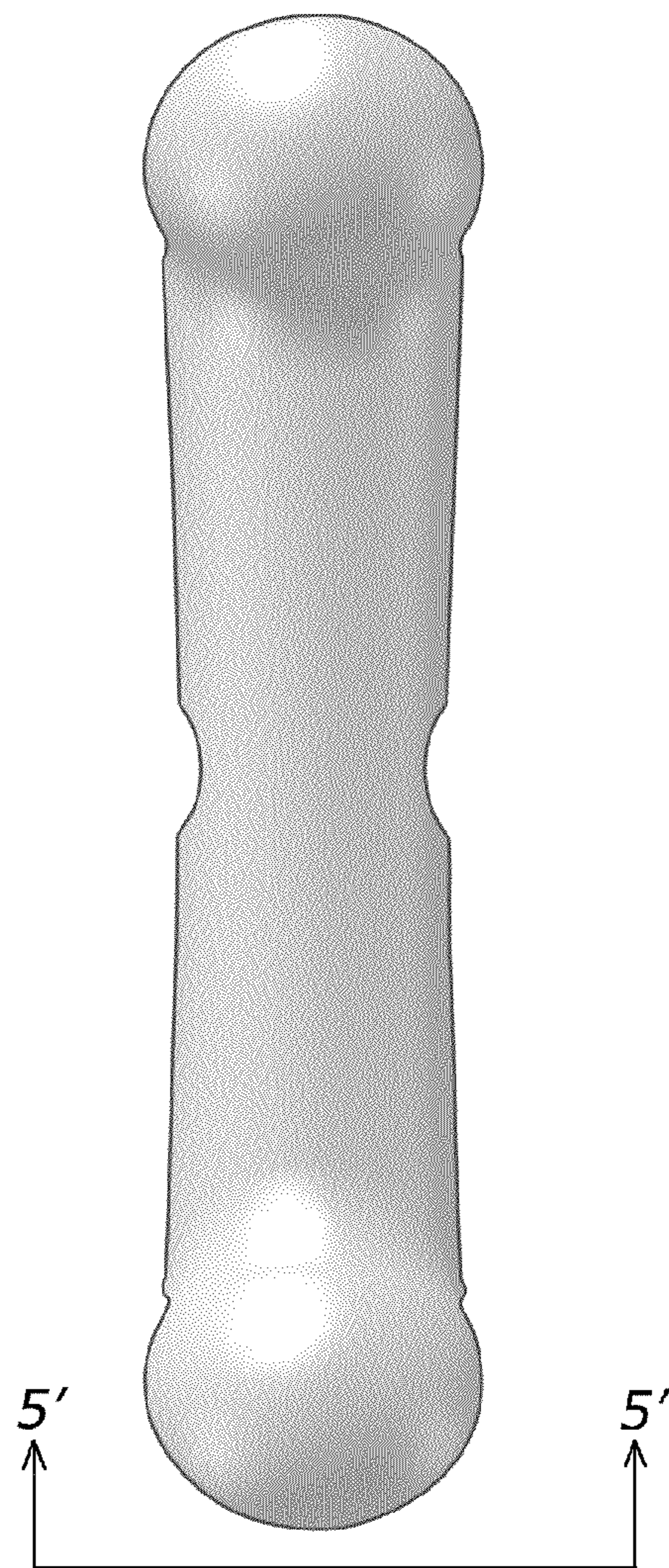

FIG. 2

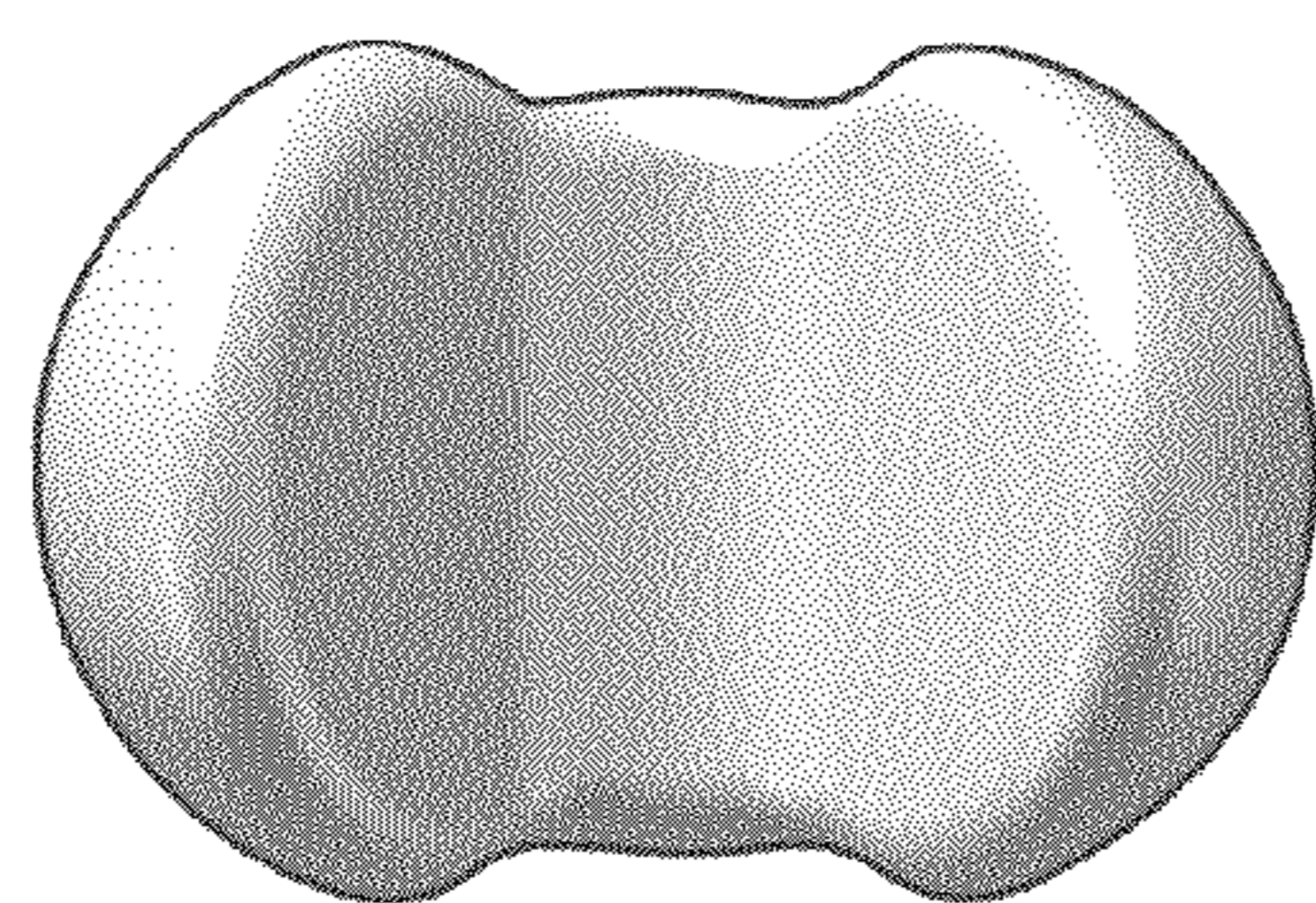

FIG. 3

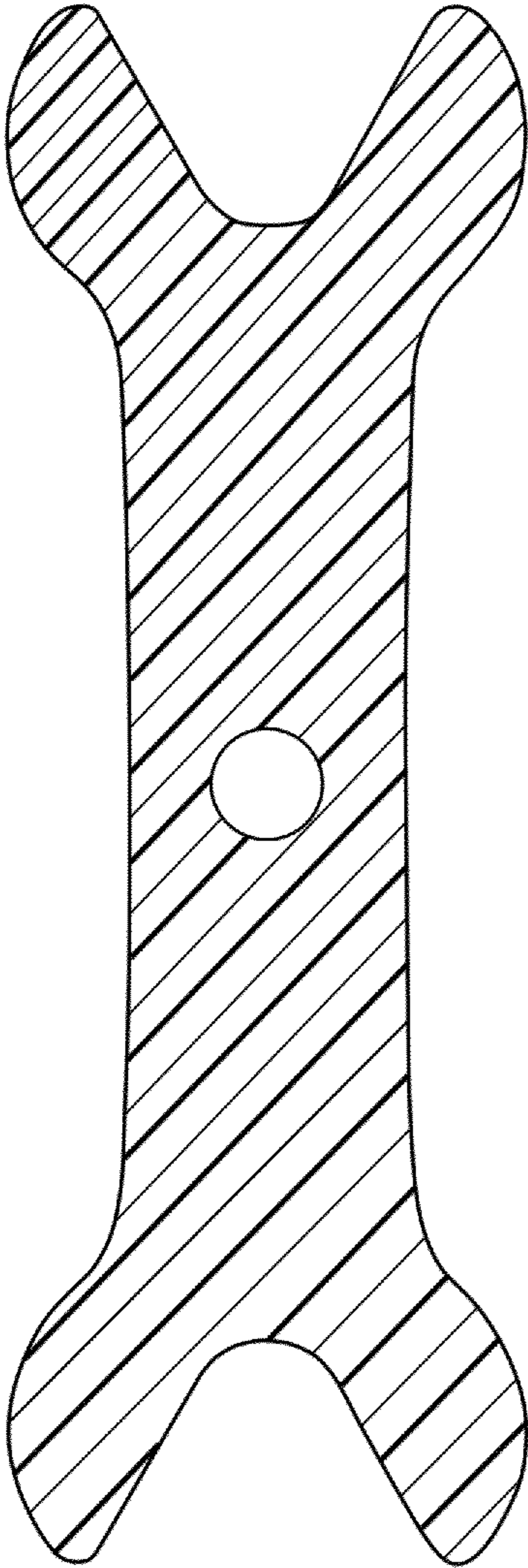

FIG. 4

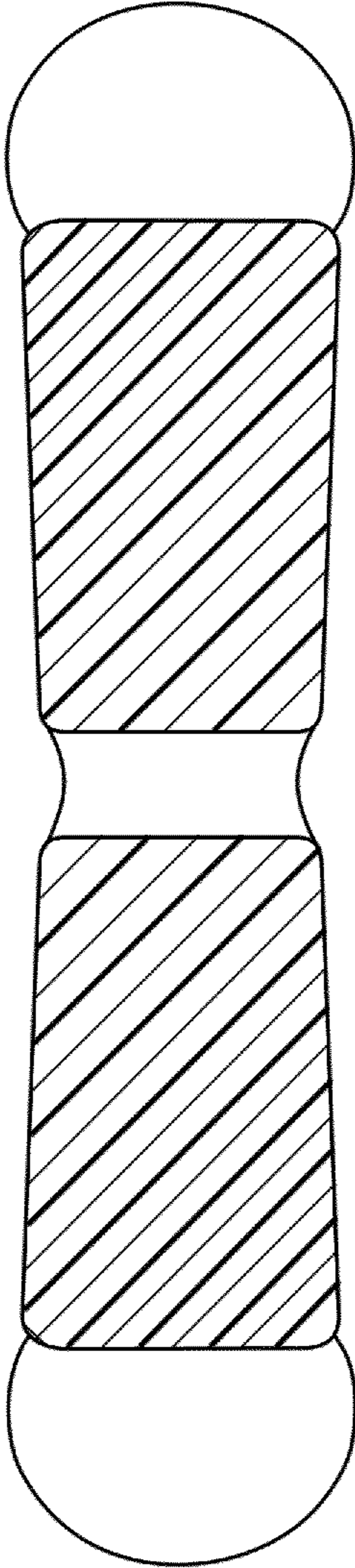

FIG. 5

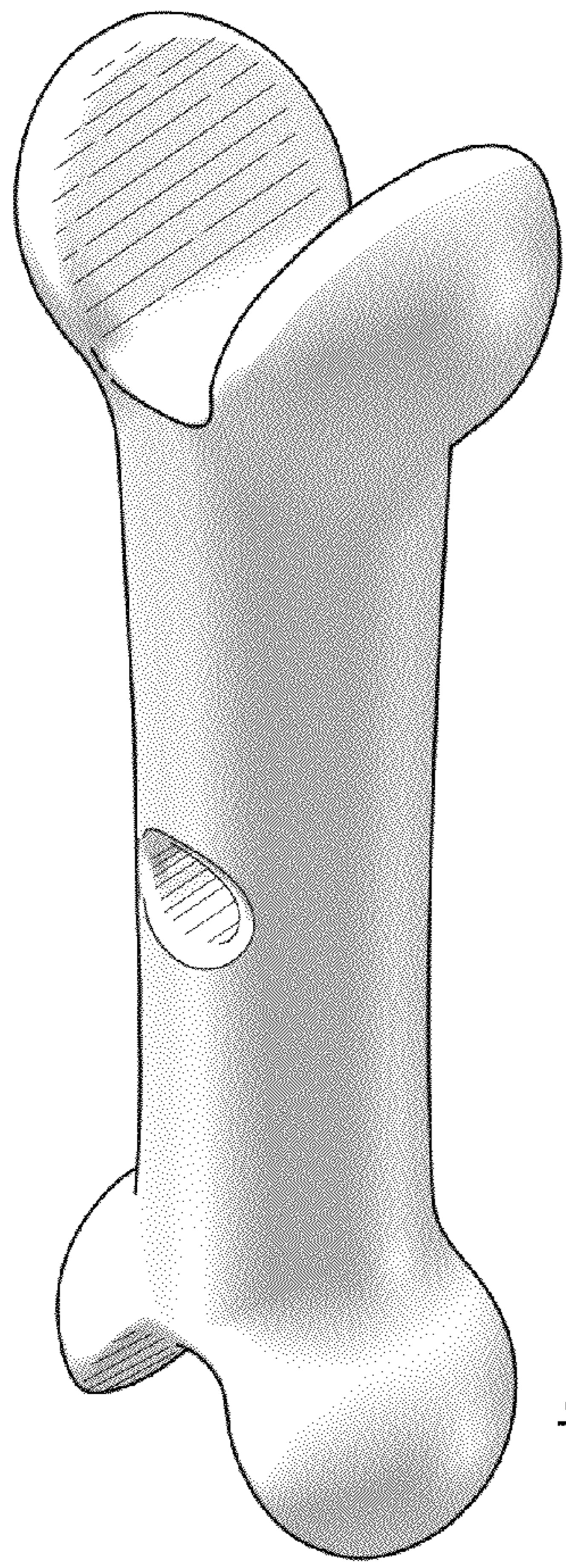

FIG. 6



FIG. 7

