



US00D701300S

(12) **United States Design Patent**
Tanabe et al.

(10) **Patent No.:** **US D701,300 S**
(45) **Date of Patent:** **** Mar. 18, 2014**

(54) **IMPELLER OF ELECTRIC FAN**
(71) Applicant: **Panasonic Corporation**, Kadoma (JP)
(72) Inventors: **Yuichi Tanabe**, Osaka (JP); **Masahiko Morisaki**, Osaka (JP); **Michihiro Kurokawa**, Osaka (JP); **Yoshio Chiba**, Osaka (JP); **Hirokazu Takahara**, Osaka (JP)

D575,749 S * 8/2008 Hwang et al. D13/179
D577,807 S * 9/2008 Kenyon et al. D23/379
D579,883 S * 11/2008 Hwang et al. D13/179
D630,721 S * 1/2011 Kenyon et al. D23/379
D645,950 S * 9/2011 Kenyon et al. D23/379

FOREIGN PATENT DOCUMENTS

JP D1117972 S 8/2001
JP D1148255 S 7/2002

* cited by examiner

(73) Assignee: **Panasonic Corporation**, Osaka (JP)
(**) Term: **14 Years**

Primary Examiner — Susan Bennett Hattan
Assistant Examiner — Janice Hallmark

(21) Appl. No.: **29/448,210**

(74) *Attorney, Agent, or Firm* — Brinks Gilson & Lione

(22) Filed: **Mar. 11, 2013**

(51) **LOC (10) Cl.** **23-04**

(52) **U.S. Cl.**
USPC **D23/379**

(58) **Field of Classification Search**
USPC D23/370–385, 411–414, 365, 364;
415/60, 66, 68, 208.1, 213.1, 214.1;
310/257; 361/695; 126/299 D, 299 R;
D26/51, 72, 73; D32/15, 16
See application file for complete search history.

(57) **CLAIM**

We claim the ornamental design for an impeller of electric fan, as shown and described.

(56) **References Cited**

U.S. PATENT DOCUMENTS

3,159,106 A * 12/1964 Schumbacker et al. .. 416/186 R
D421,798 S * 3/2000 Liang D23/379
D443,281 S * 6/2001 Sodergard D15/7
D506,820 S * 6/2005 Meng-Suen D23/377
D511,824 S * 11/2005 Chen et al. D23/370

DESCRIPTION

FIG. 1 is a top perspective view of an impeller of electric fan of the present invention;
FIG. 2 is a bottom perspective view thereof;
FIG. 3 is a top view thereof;
FIG. 4 is a bottom view thereof;
FIG. 5 is a front view thereof;
FIG. 6 is a rear view thereof;
FIG. 7 is a left side view thereof;
FIG. 8 is a right side view thereof; and,
FIG. 9 is a cross-section view taken along the line 9 of FIG. 3.

1 Claim, 7 Drawing Sheets

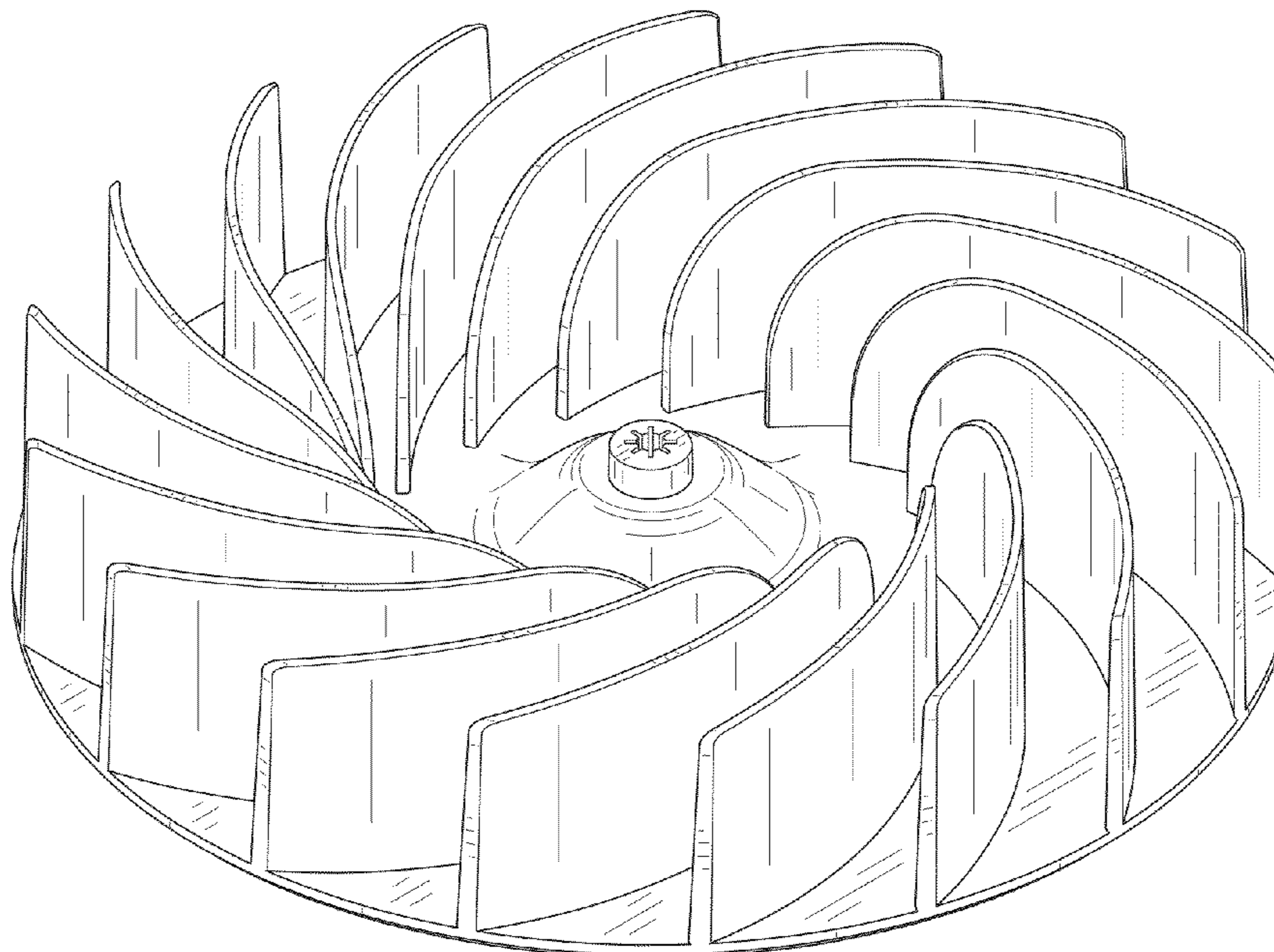

FIG. 1

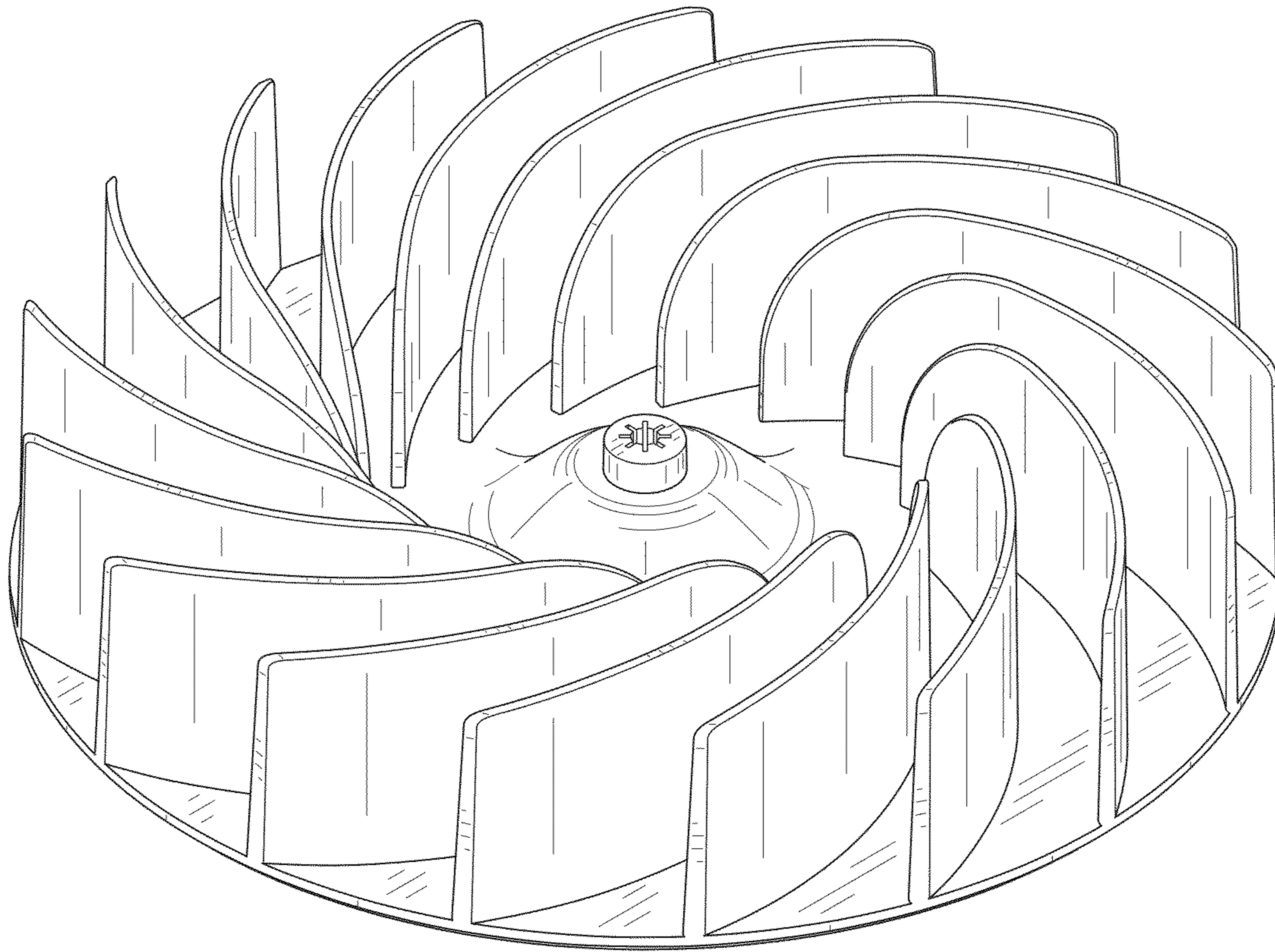

FIG. 2

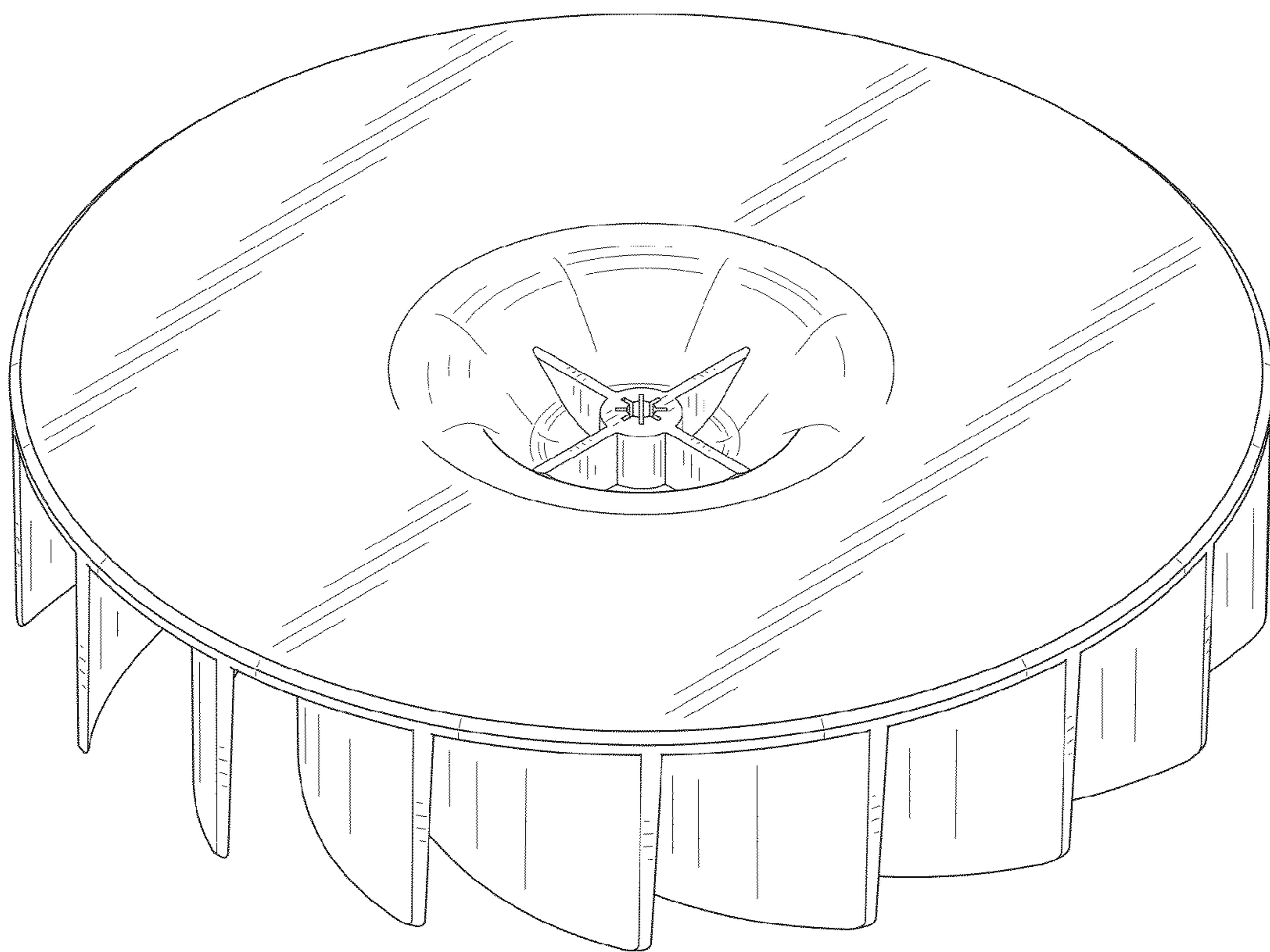

FIG. 3

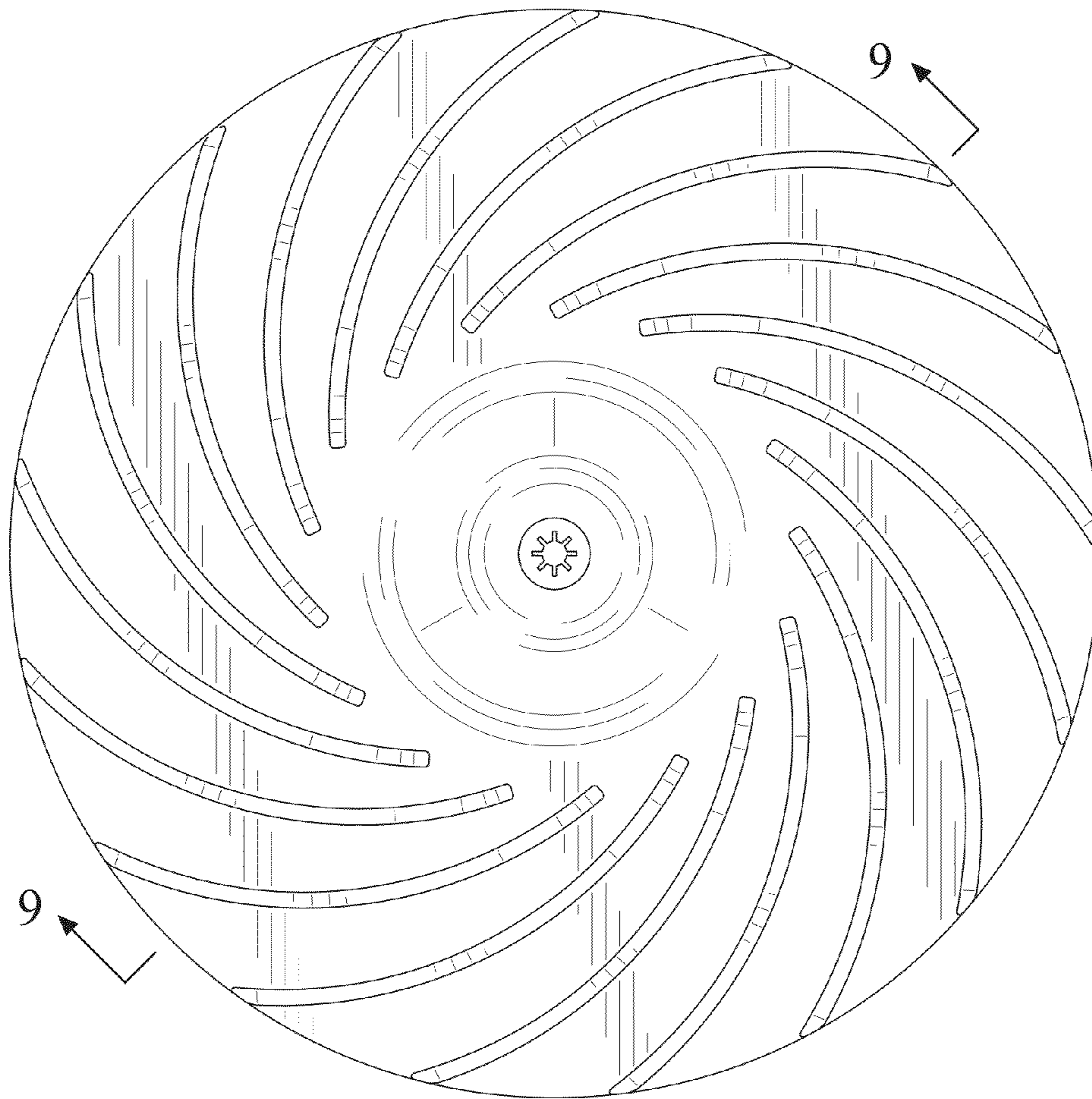

FIG.4



FIG. 5

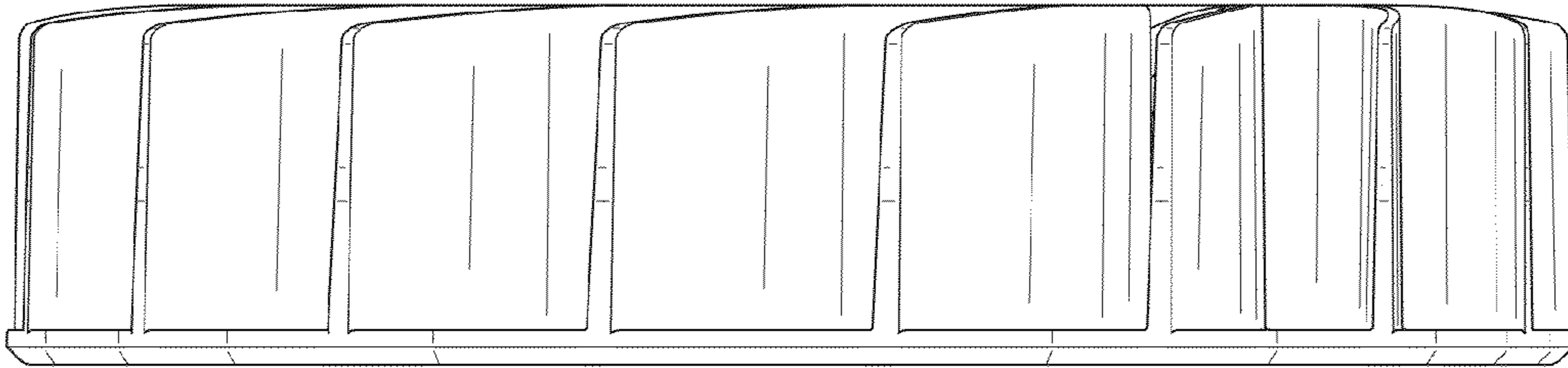

FIG. 6

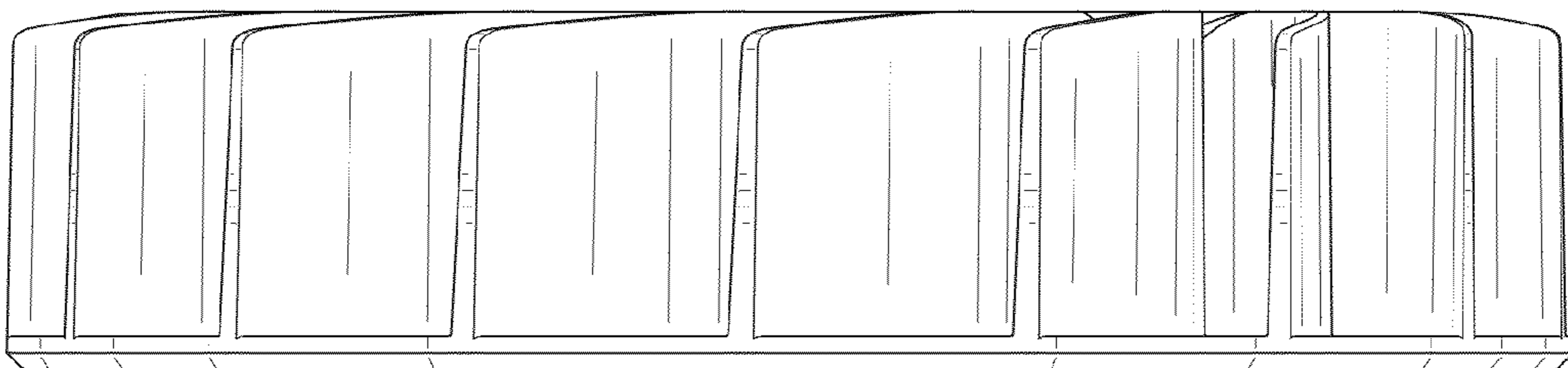

FIG. 7

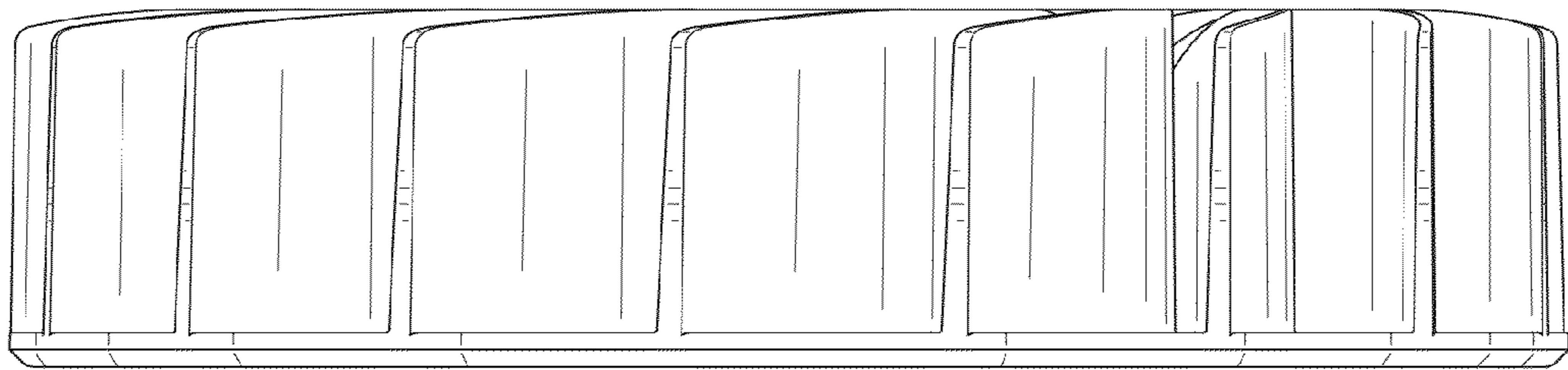

FIG. 8

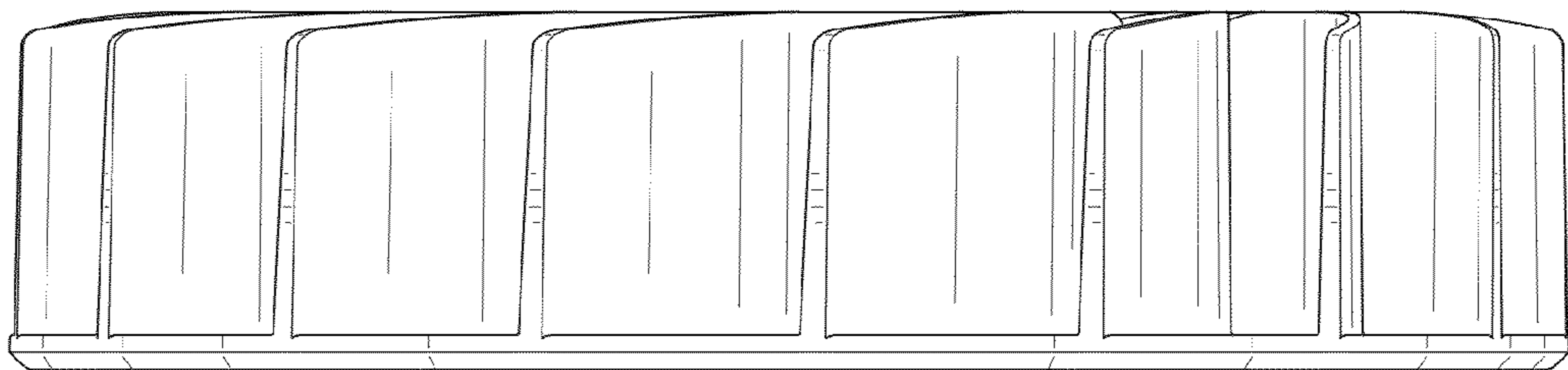

FIG. 9

