



US00D701294S

(12) **United States Design Patent**
Adams et al.

(10) **Patent No.:** **US D701,294 S**
(45) **Date of Patent:** **** Mar. 18, 2014**

(54) **BATHING ENCLOSURE**

(71) Applicant: **Kohler Co.**, Kohler, WI (US)

(72) Inventors: **John Adams**, Sheboygan, WI (US);
Weerasak Taingtae, Sheboygan, WI (US)

(73) Assignee: **Kohler Co.**, Kohler, WI (US)

(**) Term: **14 Years**

(21) Appl. No.: **29/449,909**

(22) Filed: **Mar. 15, 2013**

(51) **LOC (10) Cl.** **23-02**

(52) **U.S. Cl.**
USPC **D23/305**

(58) **Field of Classification Search**
USPC D23/277, 280.1, 304, 275, 283, 305,
D23/303; 4/538, 614, 612, 596, 584
See application file for complete search history.

(56) **References Cited**

U.S. PATENT DOCUMENTS

D255,707 S	*	7/1980	Obradovits	D23/305
D278,844 S	*	5/1985	Stairs, Jr.	D23/277
D482,763 S	*	11/2003	Thomas	D23/280.1
D576,262 S	*	9/2008	Ishiyama et al.	D23/305
D601,672 S	*	10/2009	Garrels	D23/275

* cited by examiner

Primary Examiner — Robert Delehanty

(74) *Attorney, Agent, or Firm* — Foley & Lardner LLP

(57) **CLAIM**

We claim the ornamental design for a bathing enclosure, as shown and described.

DESCRIPTION

FIG. 1 is a top perspective view of an embodiment of the claimed design;

FIG. 2 is a front elevation view of the claimed design of FIG. 1;

FIG. 3 is a top plan view of the claimed design of FIG. 1;

FIG. 4 is a right-side elevation view of the claimed design of FIG. 1;

FIG. 5 is a left-side elevation view of the claimed design of FIG. 1;

FIG. 6 is a bottom plan view of the claimed design of FIG. 1; and

FIG. 7 is a rear elevation view of the claimed design of FIG. 1;

FIG. 8 is a top perspective view of another embodiment of the claimed design;

FIG. 9 is a front elevation view of the claimed design of FIG. 8;

FIG. 10 is a top plan view of the claimed design of FIG. 8;

FIG. 11 is a right-side elevation view of the claimed design of FIG. 8;

FIG. 12 is a left-side elevation view of the claimed design of FIG. 8;

FIG. 13 is a bottom plan view of the claimed design of FIG. 8; and,

FIG. 14 is a rear elevation view of the claimed design of FIG. 8.

The ornamental design which is claimed is shown in solid lines in the drawings. The broken lines in the drawings show unclaimed subject matter and form no part of the claimed design. The dot-dash lines in the drawings define boundaries of the claimed design and form no part thereof.

1 Claim, 12 Drawing Sheets

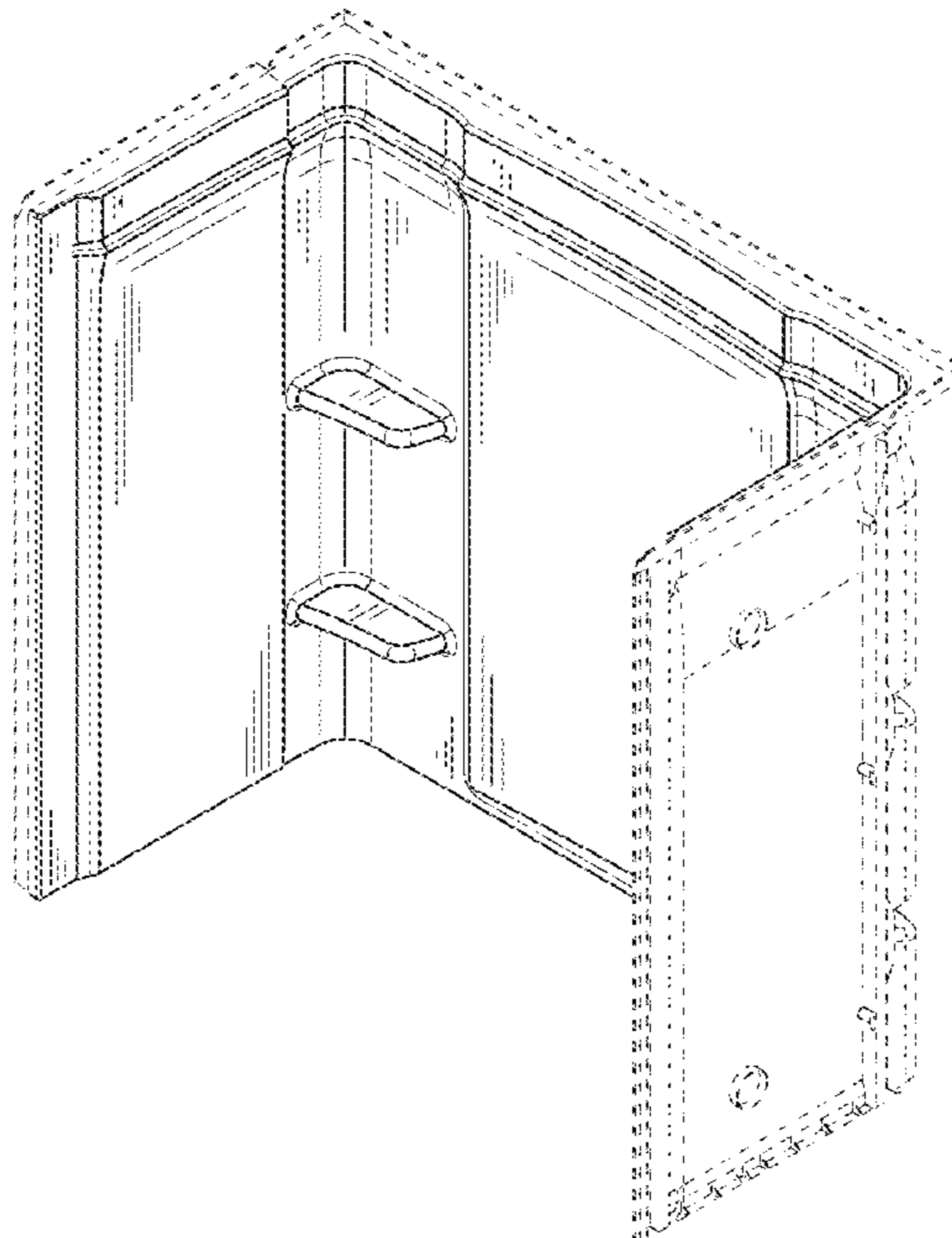

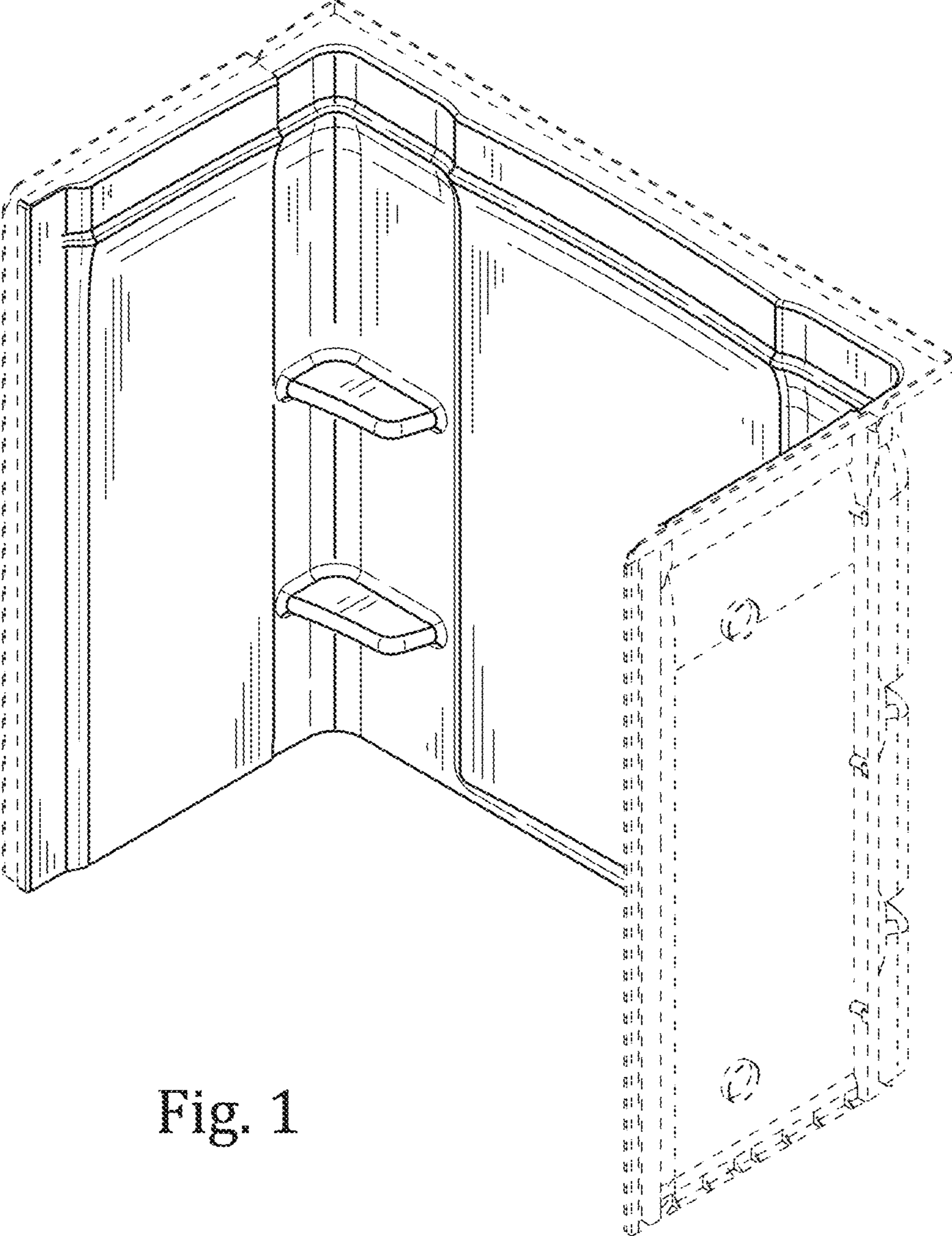

Fig. 1

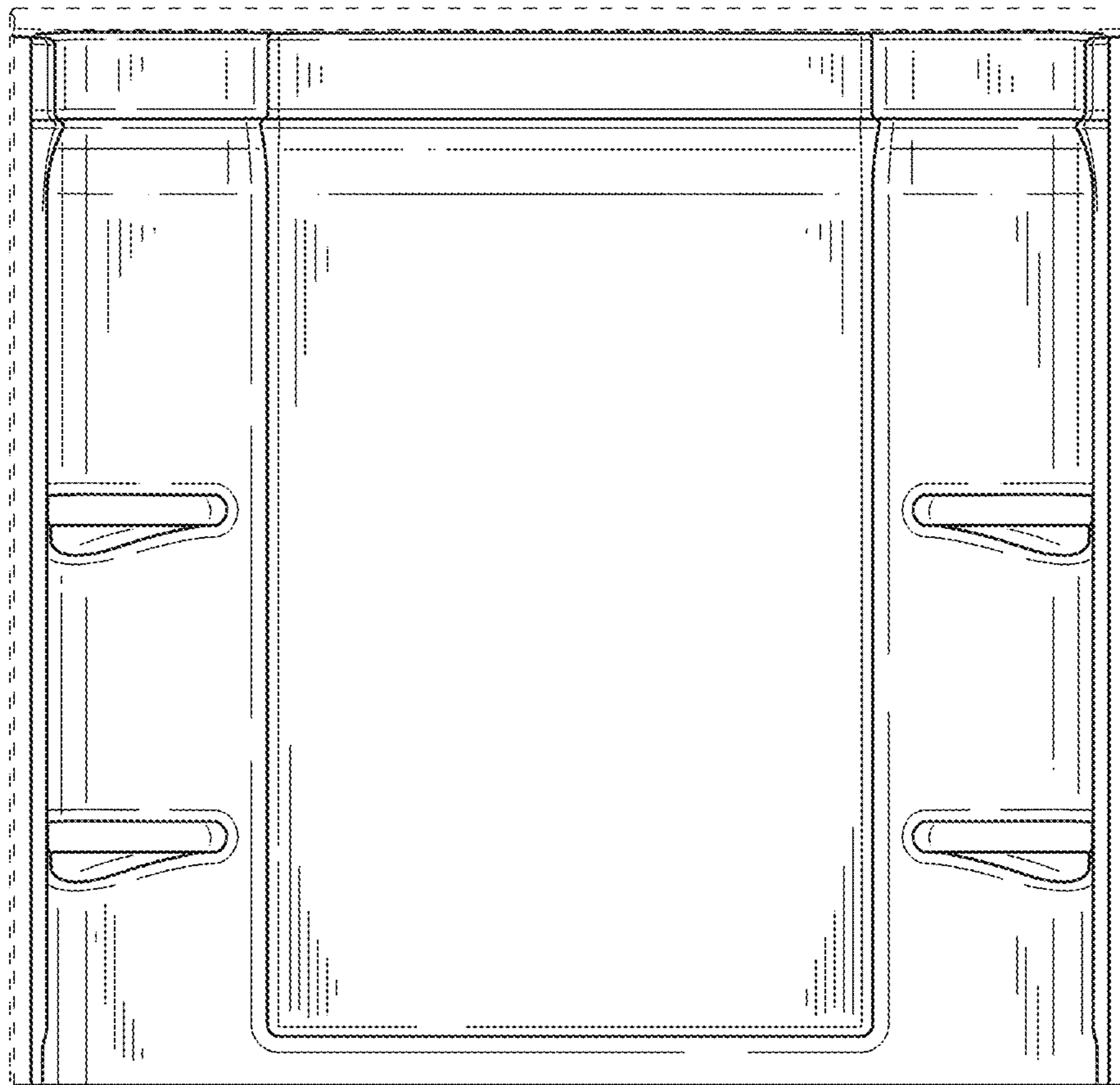

Fig. 2

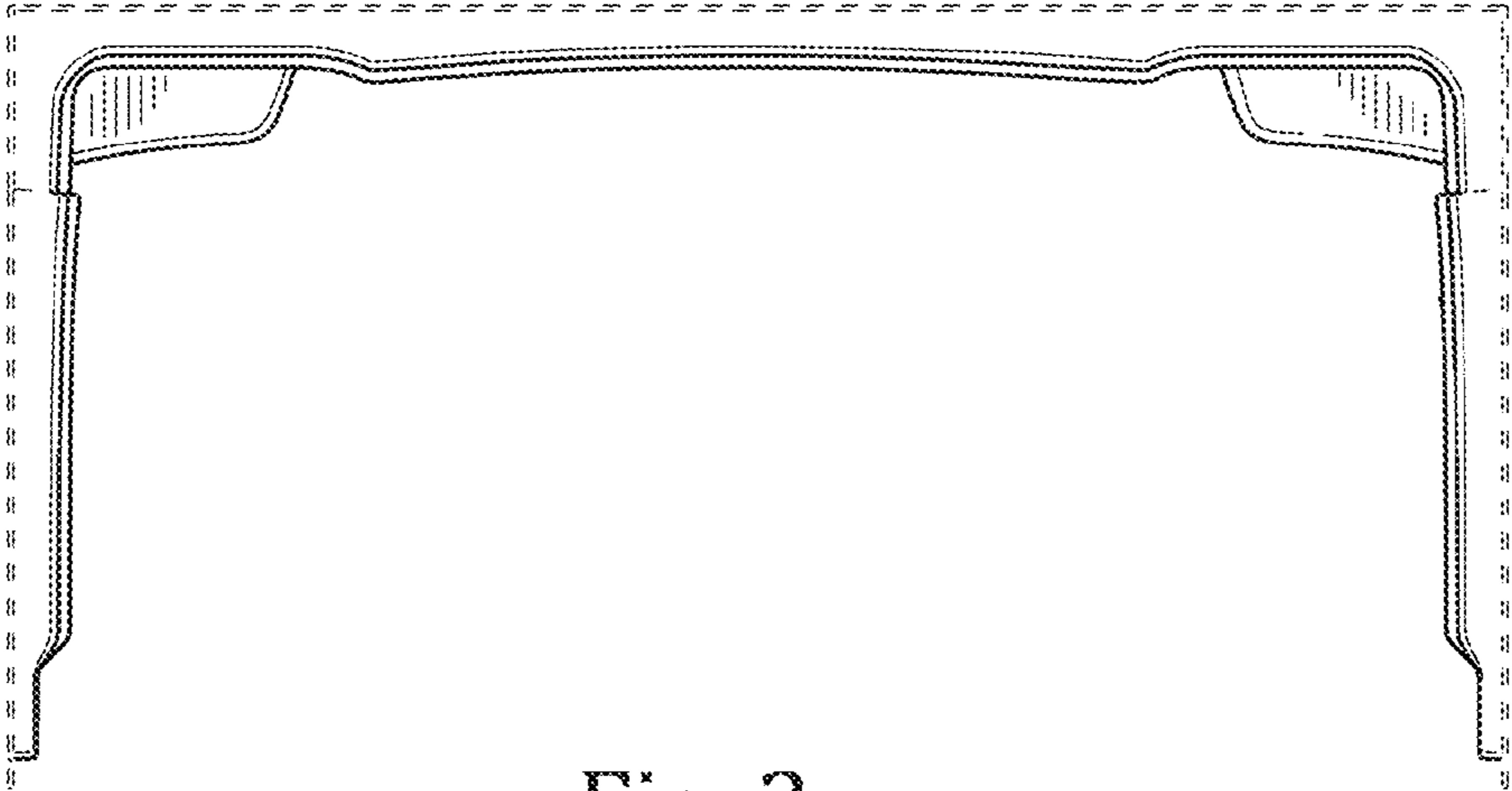

Fig. 3

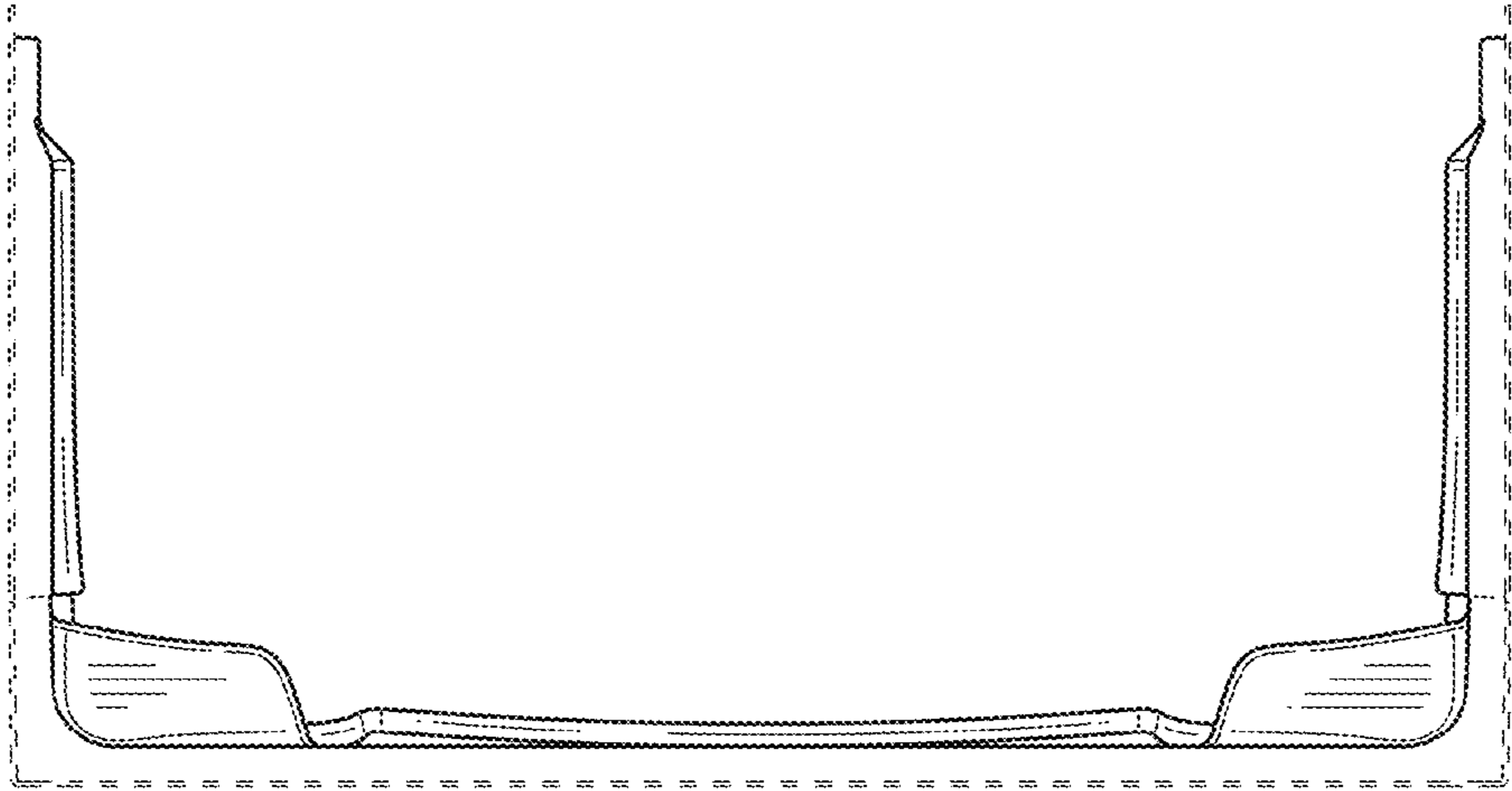

Fig. 4

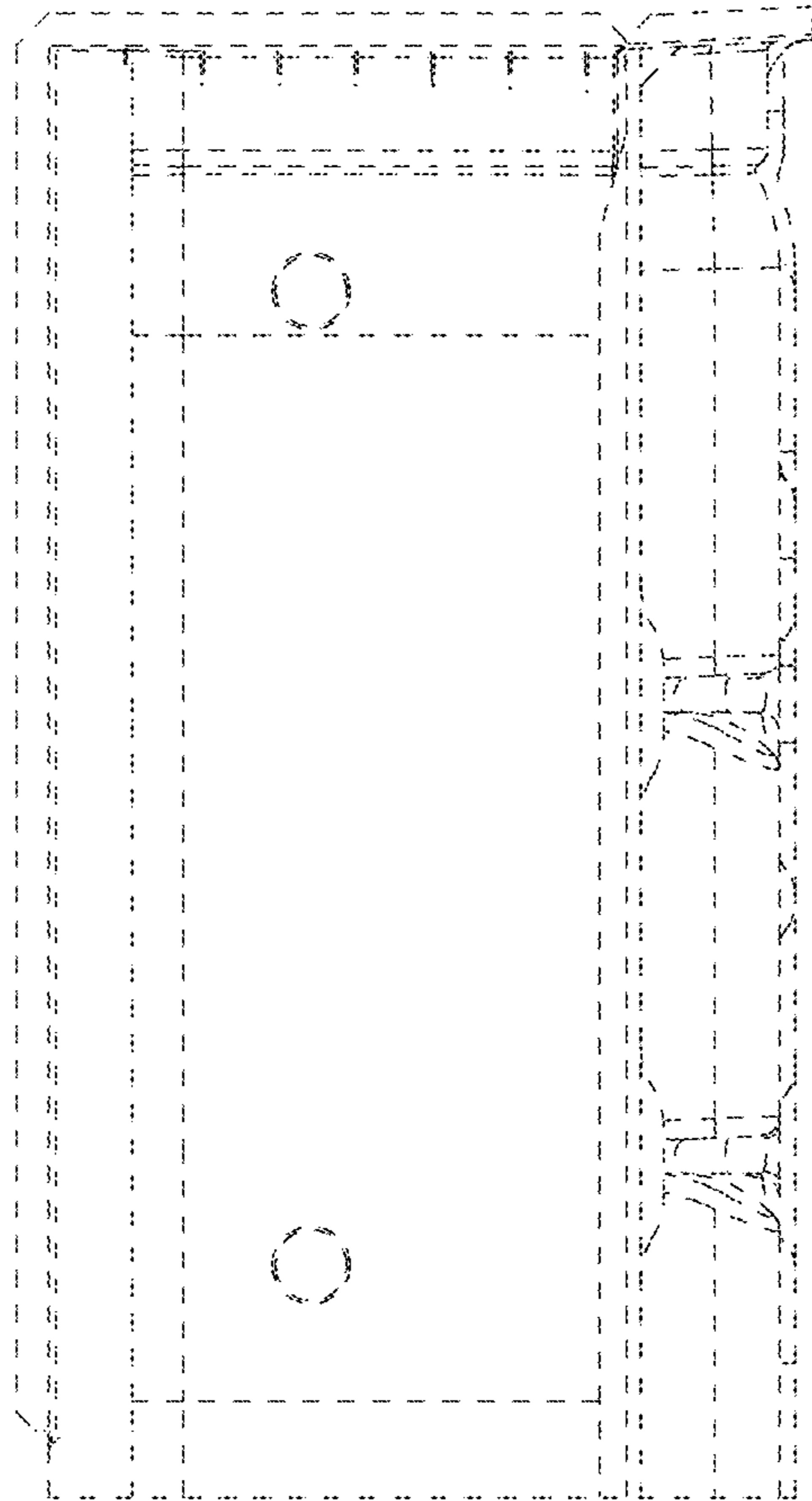

Fig. 5

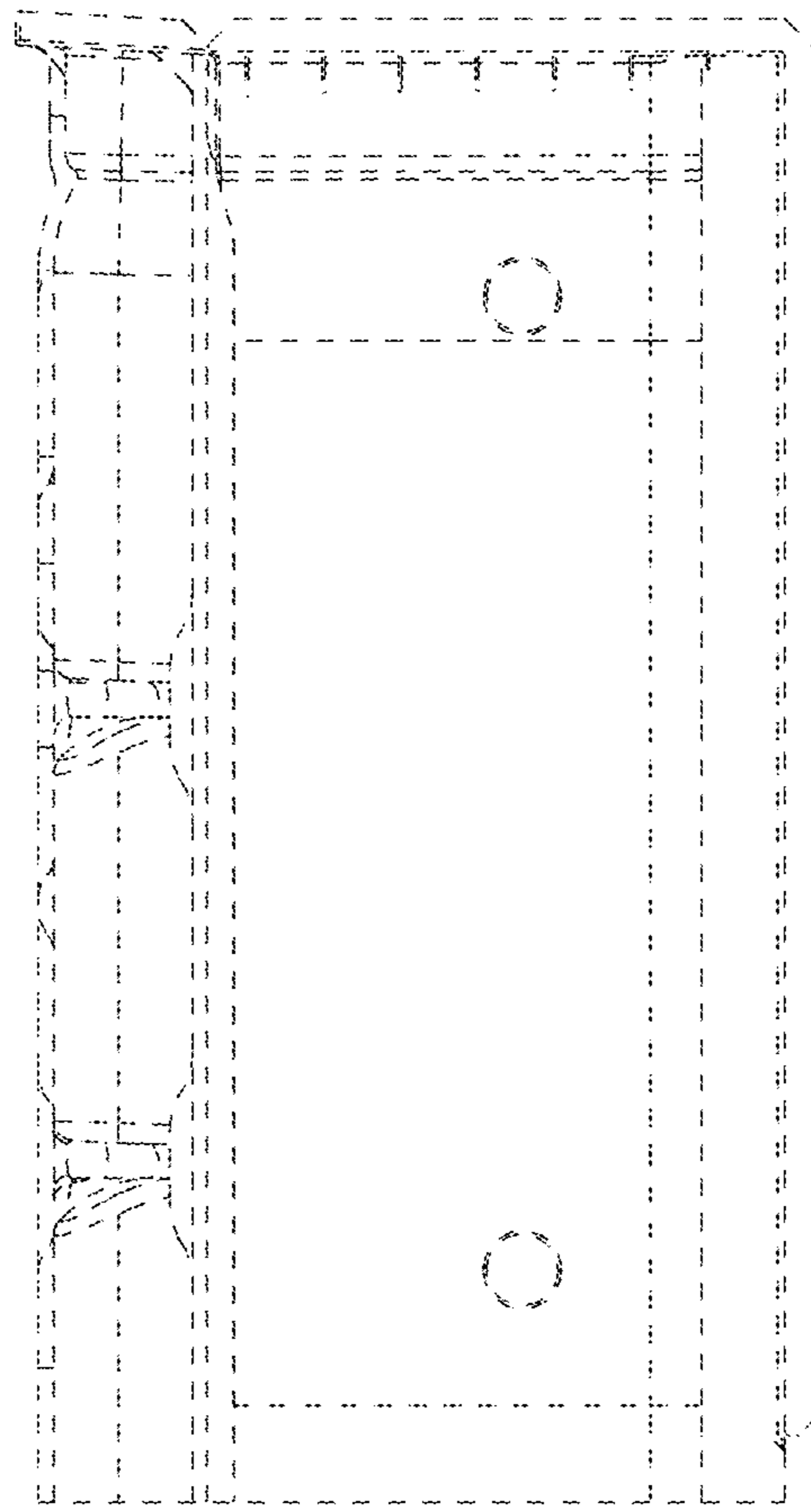

Fig. 6

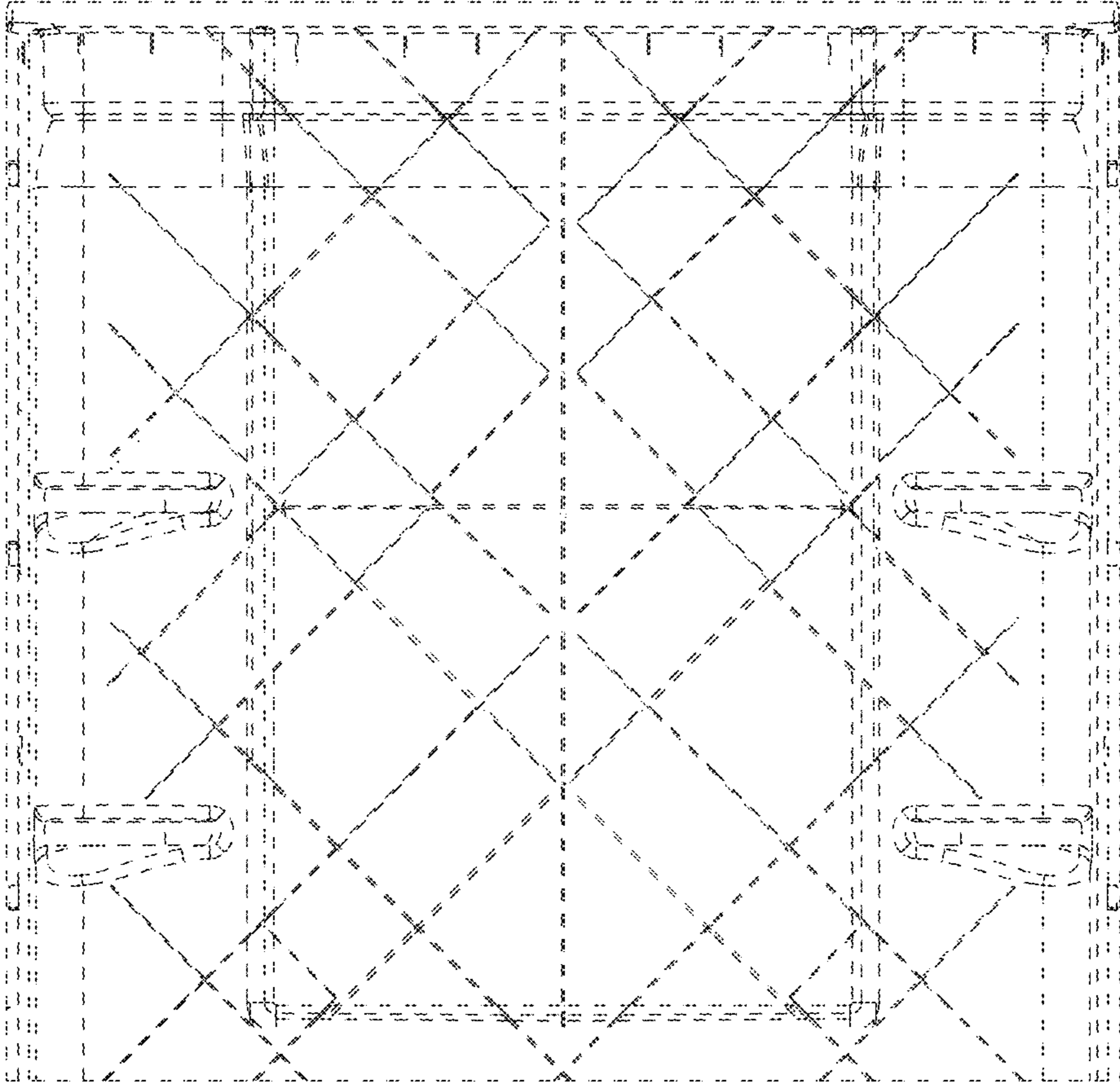

Fig. 7

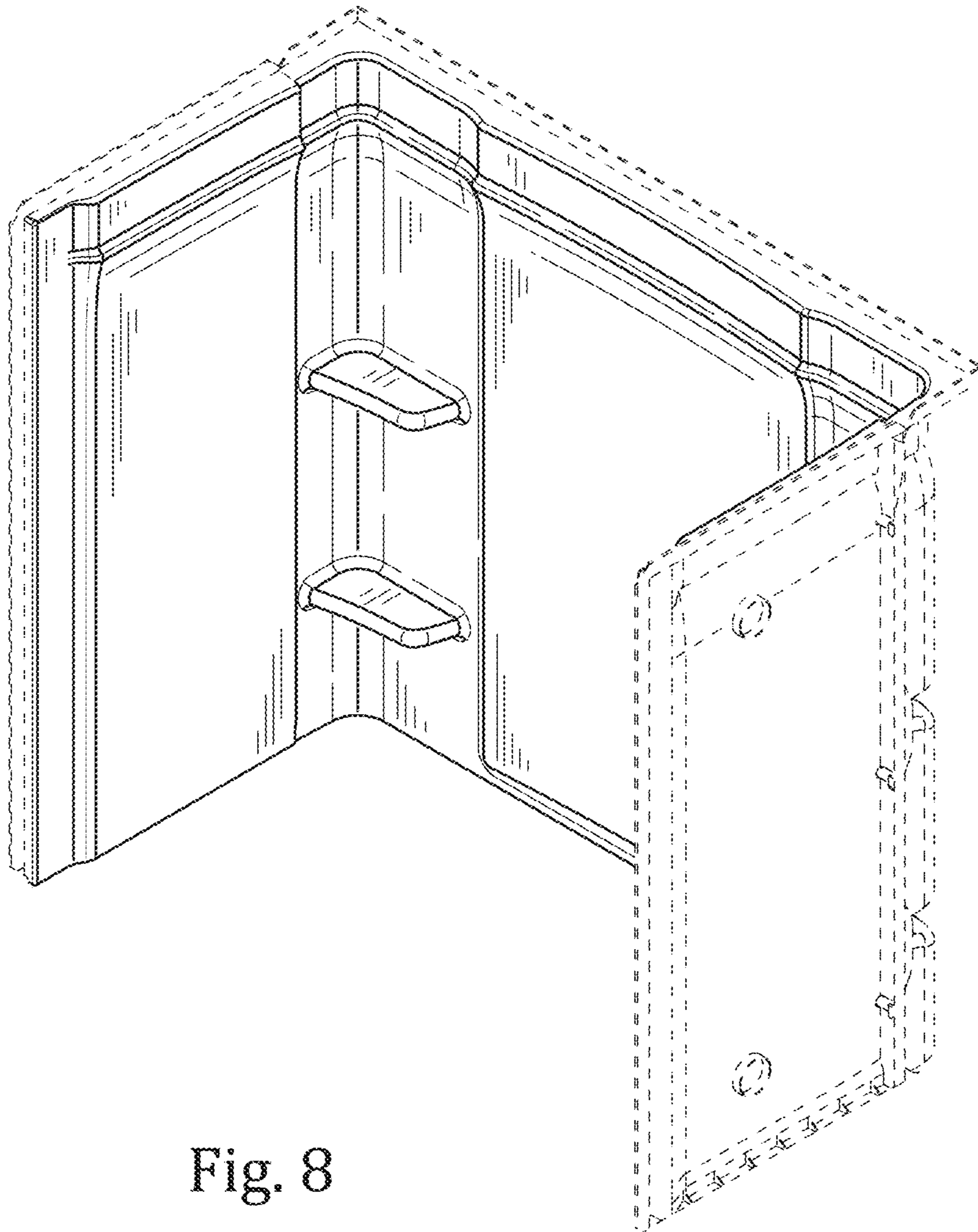

Fig. 8

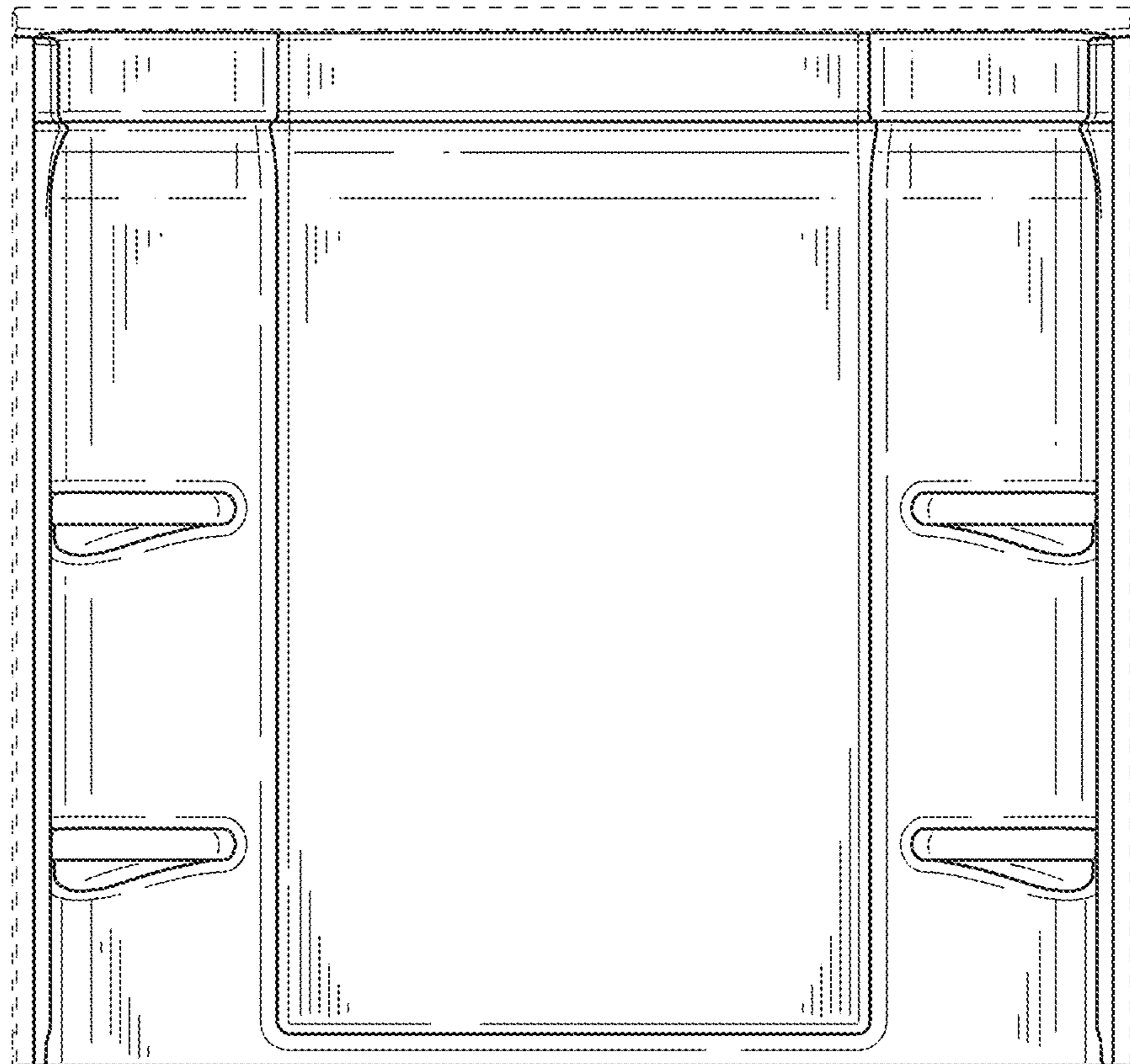

Fig. 9

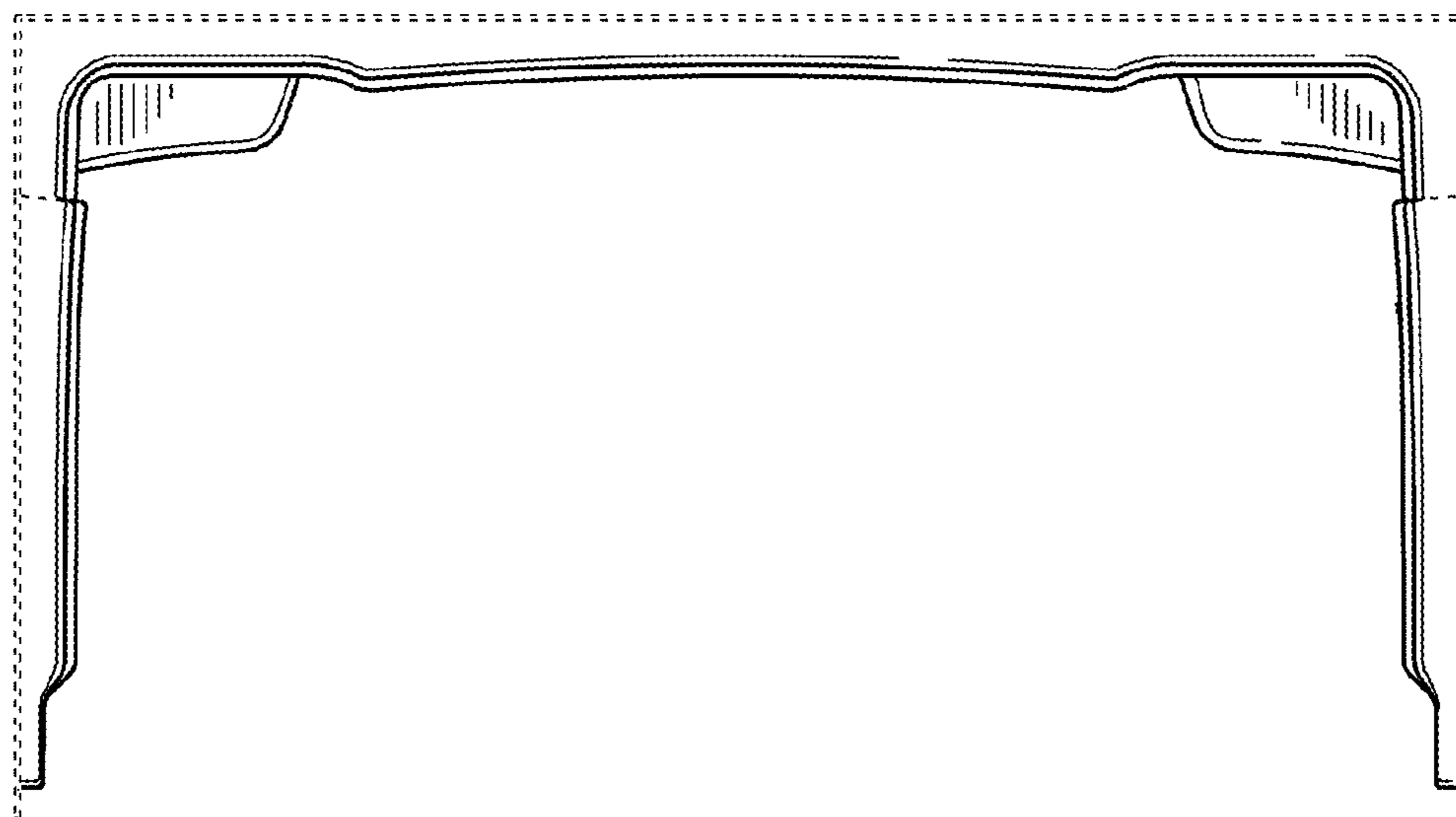

Fig. 10

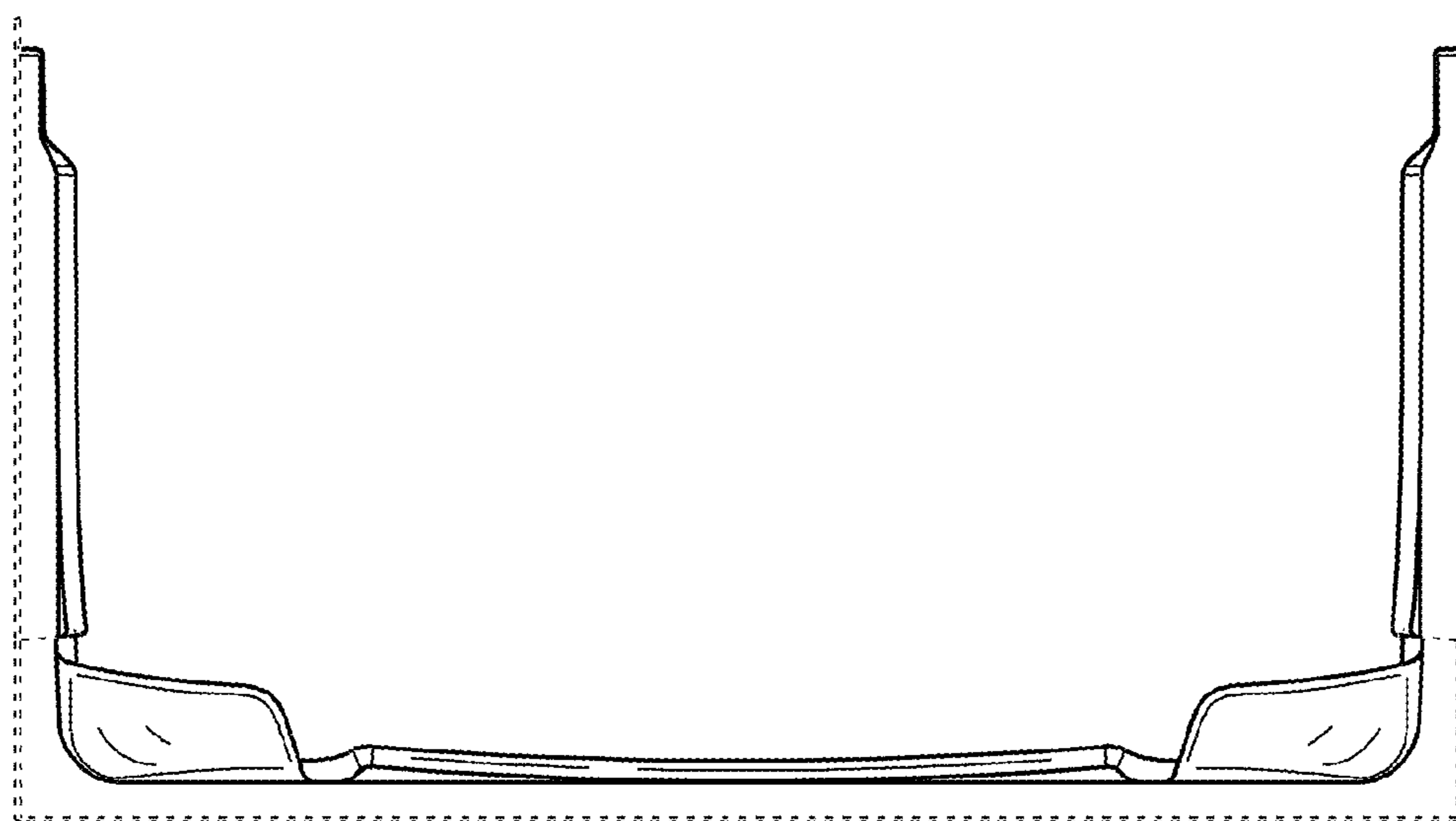

Fig. 11

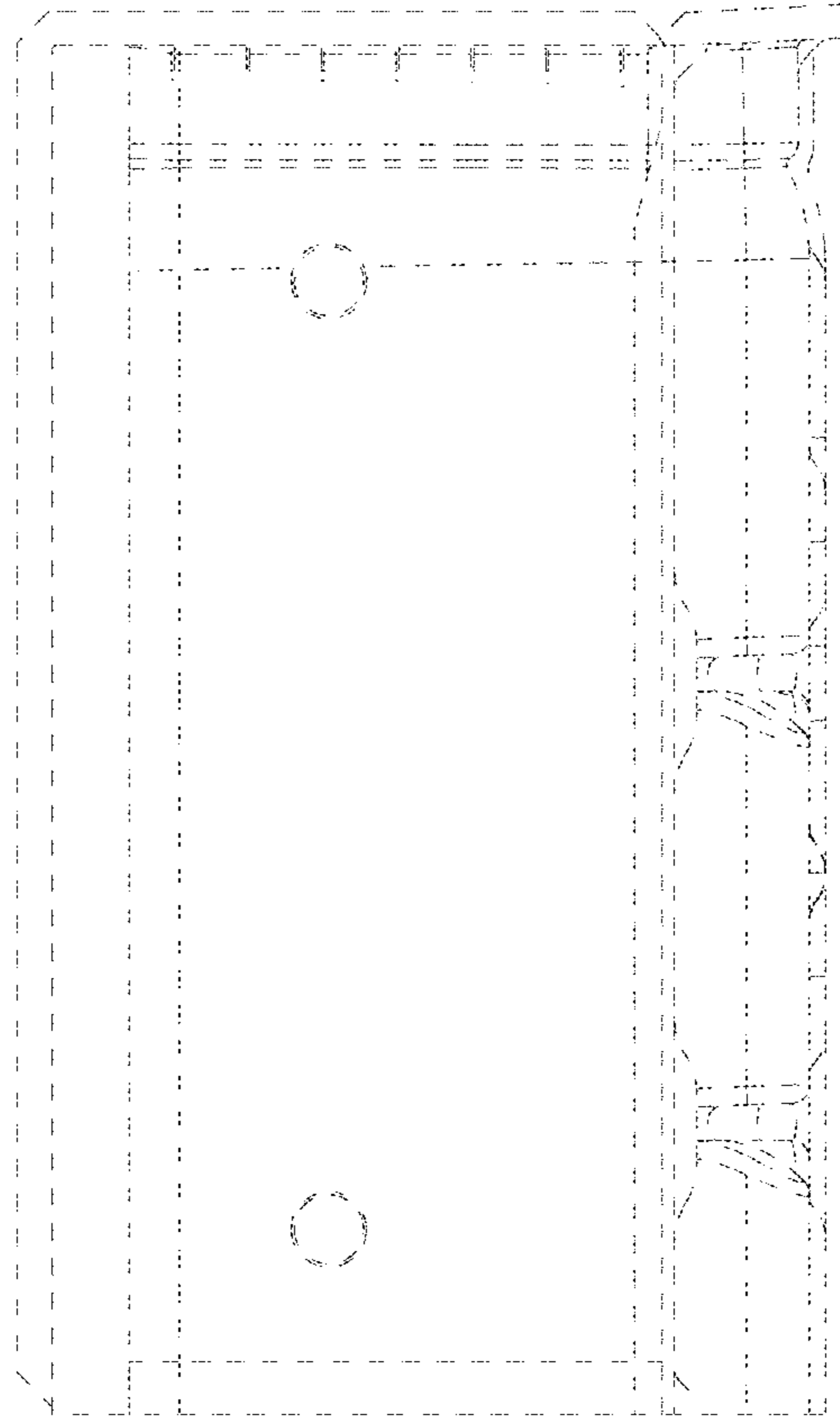

Fig. 12

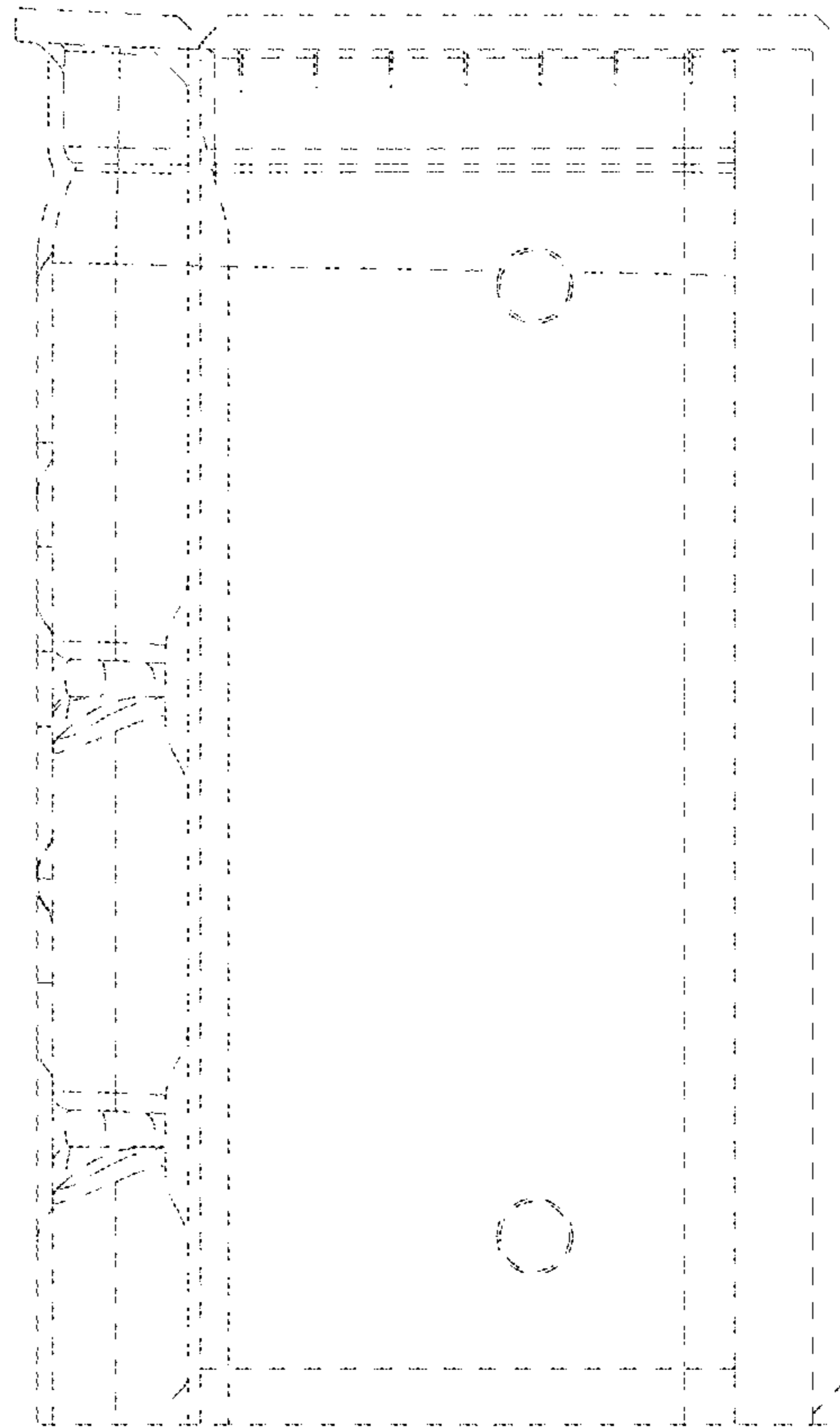

Fig. 13

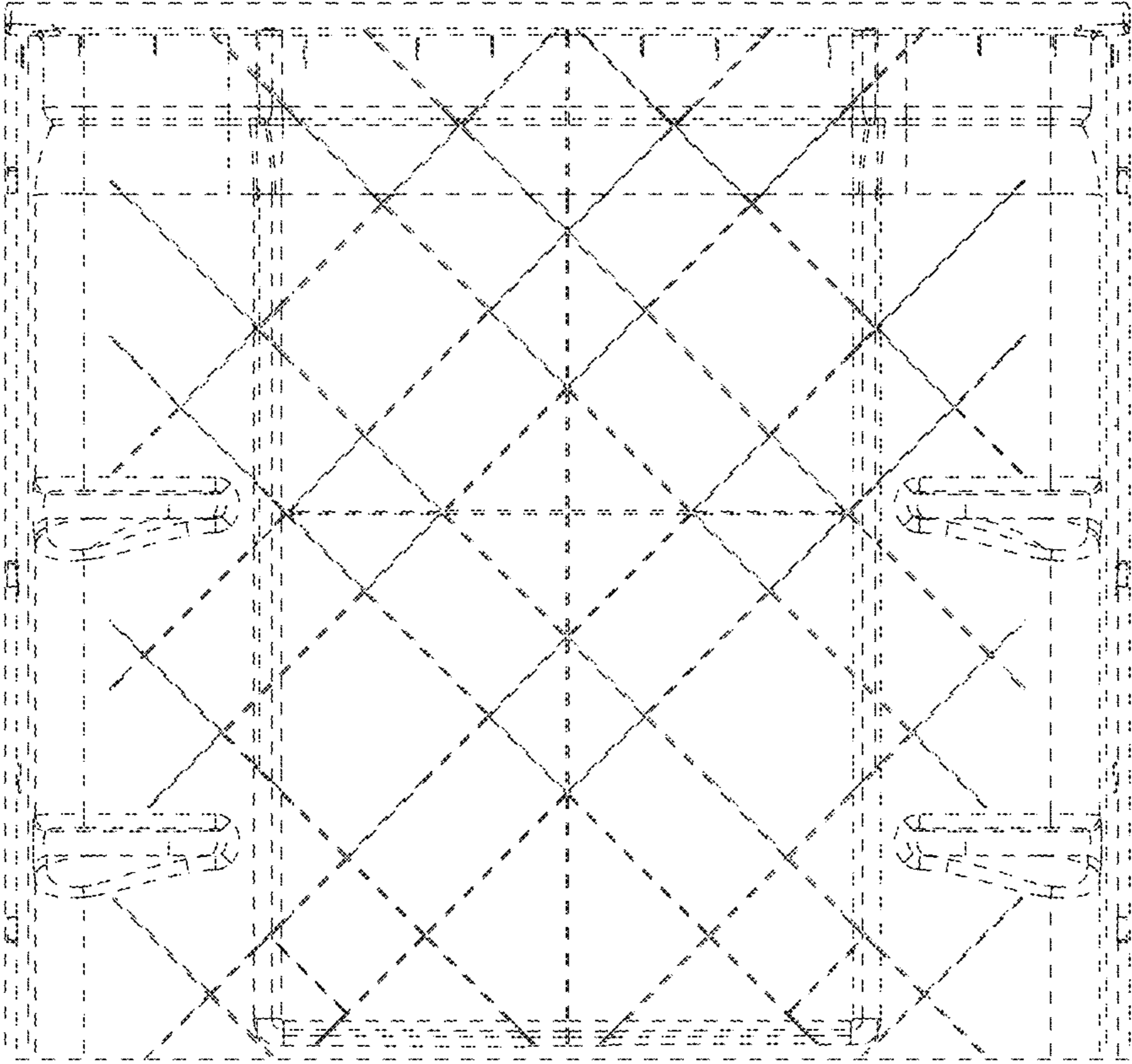

Fig. 14