

US00D701290S

(12) **United States Design Patent**  
**Streitwieser**

(10) **Patent No.:** **US D701,290 S**  
(45) **Date of Patent:** **\*\* Mar. 18, 2014**

(54) **HANDHELD SHOWER**

D621,908 S \* 8/2010 Yoo et al. .... D23/223  
D652,105 S \* 1/2012 Corbett et al. .... D23/213  
D672,011 S \* 12/2012 Andrew et al. .... D23/223  
D674,879 S \* 1/2013 Spangler .... D23/223

(71) Applicant: **Masco Corporation of Indiana,**  
Indianapolis, IN (US)

\* cited by examiner

(72) Inventor: **Sarah A Streitwieser,** Coppell, TX (US)

*Primary Examiner* — Robin V Webster

(73) Assignee: **Masco Corporation of Indiana,**  
Indianapolis, IN (US)

(74) *Attorney, Agent, or Firm* — Edgar A. Zarins; Nirav D. Parikh

(\*\*) Term: **14 Years**

(57) **CLAIM**

(21) Appl. No.: **29/435,436**

The ornamental design for a handheld shower, as shown and described.

(22) Filed: **Oct. 24, 2012**

**DESCRIPTION**

(51) **LOC (10) Cl.** ..... **23-01**

(52) **U.S. Cl.**  
USPC ..... **D23/223**

(58) **Field of Classification Search**  
USPC ..... D23/213, 223, 226, 229, 230;  
239/525–526, 282–283; 4/615  
See application file for complete search history.

FIG. 1 is a perspective view of a handheld shower showing my new design;  
FIG. 2 is a rear perspective view thereof;  
FIG. 3 is a right side view thereof;  
FIG. 4 is a front view thereof;  
FIG. 5 is a left side view thereof;  
FIG. 6 is a rear view thereof;  
FIG. 7 is a top end view thereof; and,  
FIG. 8 is a bottom end view thereof.

The broken line showing is included for the purpose of illustrating and forms no part of the claimed design.

(56) **References Cited**

**U.S. PATENT DOCUMENTS**

D562,942 S \* 2/2008 Pan ..... D23/223  
D610,229 S \* 2/2010 Wu et al. .... D23/223  
D610,651 S \* 2/2010 Wu et al. .... D23/223

**1 Claim, 3 Drawing Sheets**

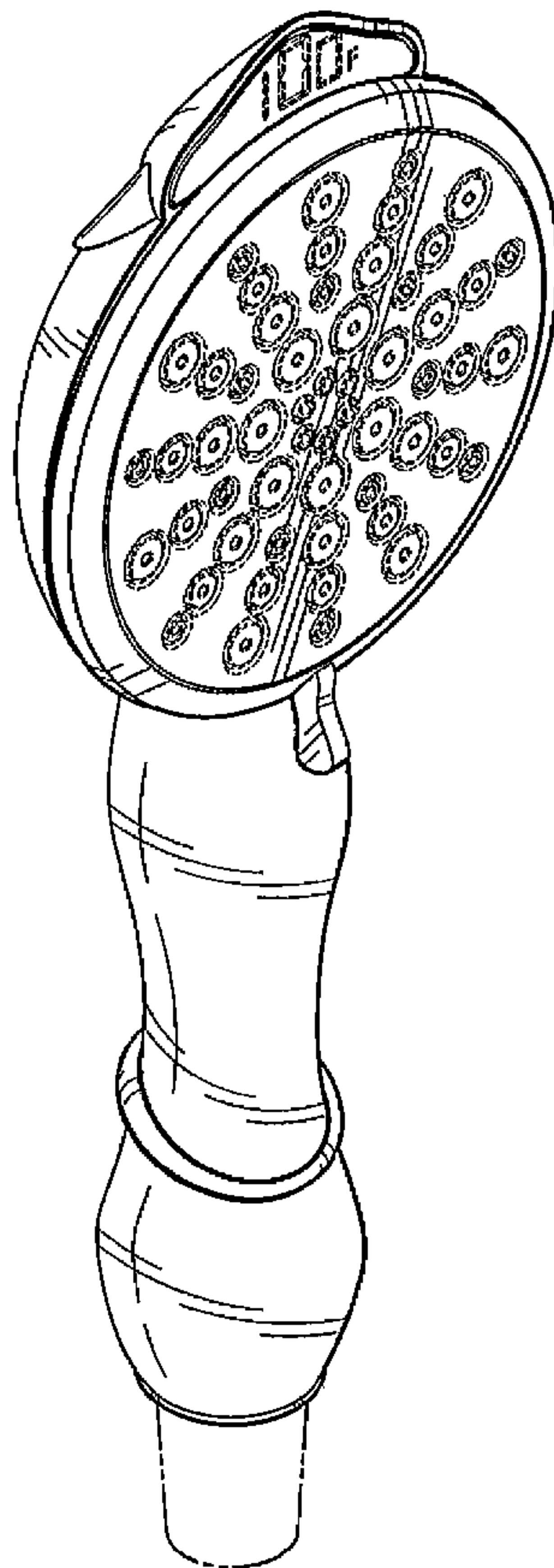

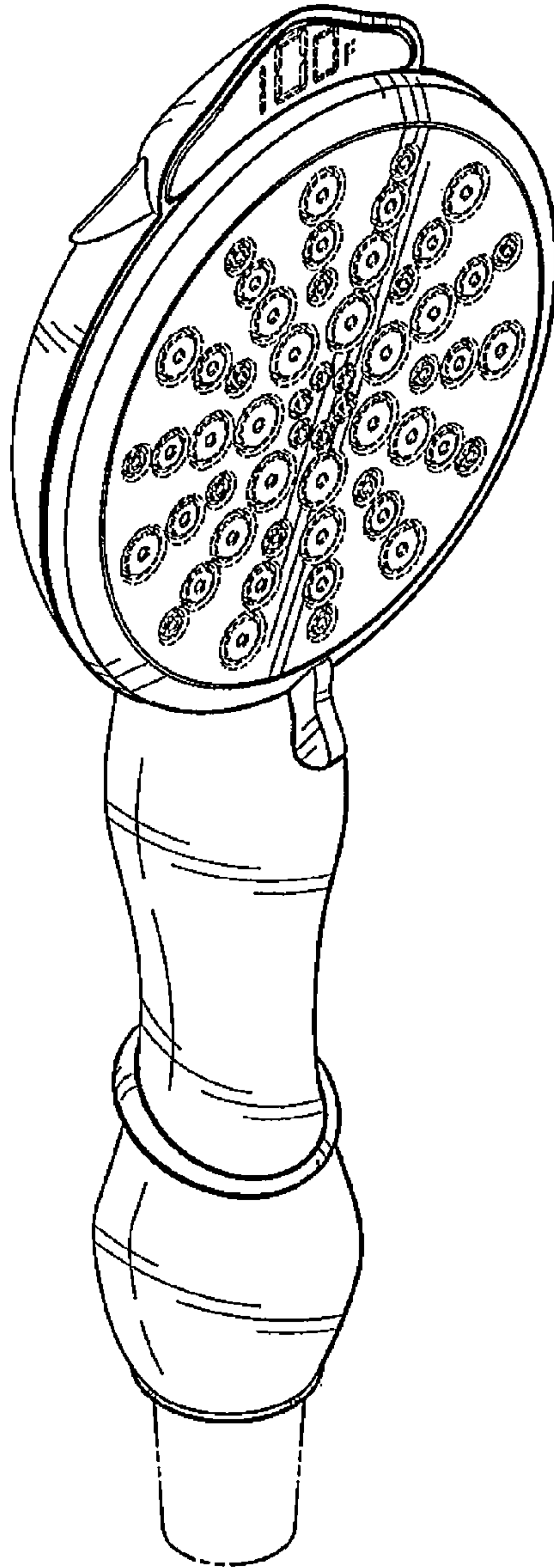

Fig-1

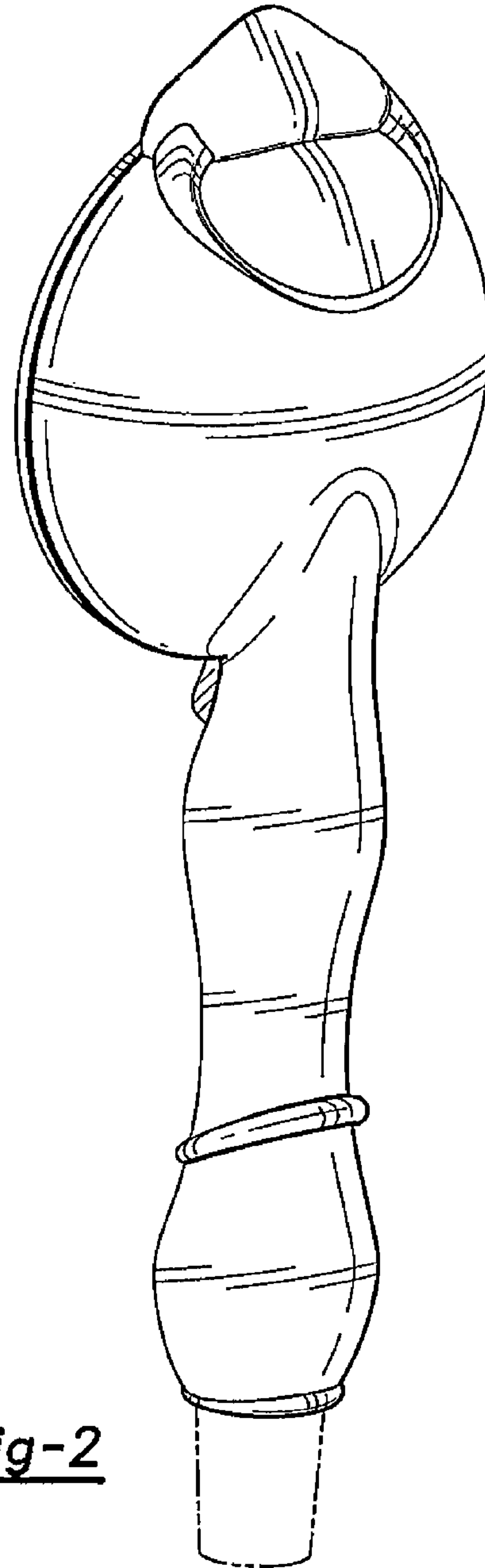

Fig-2

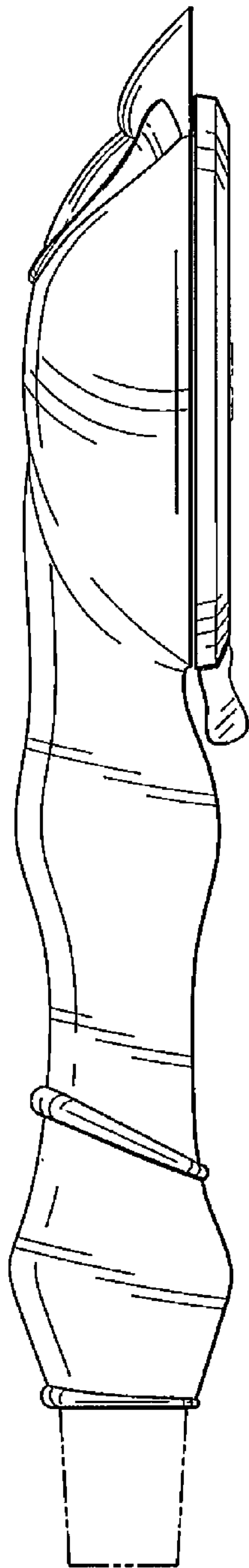

Fig-3

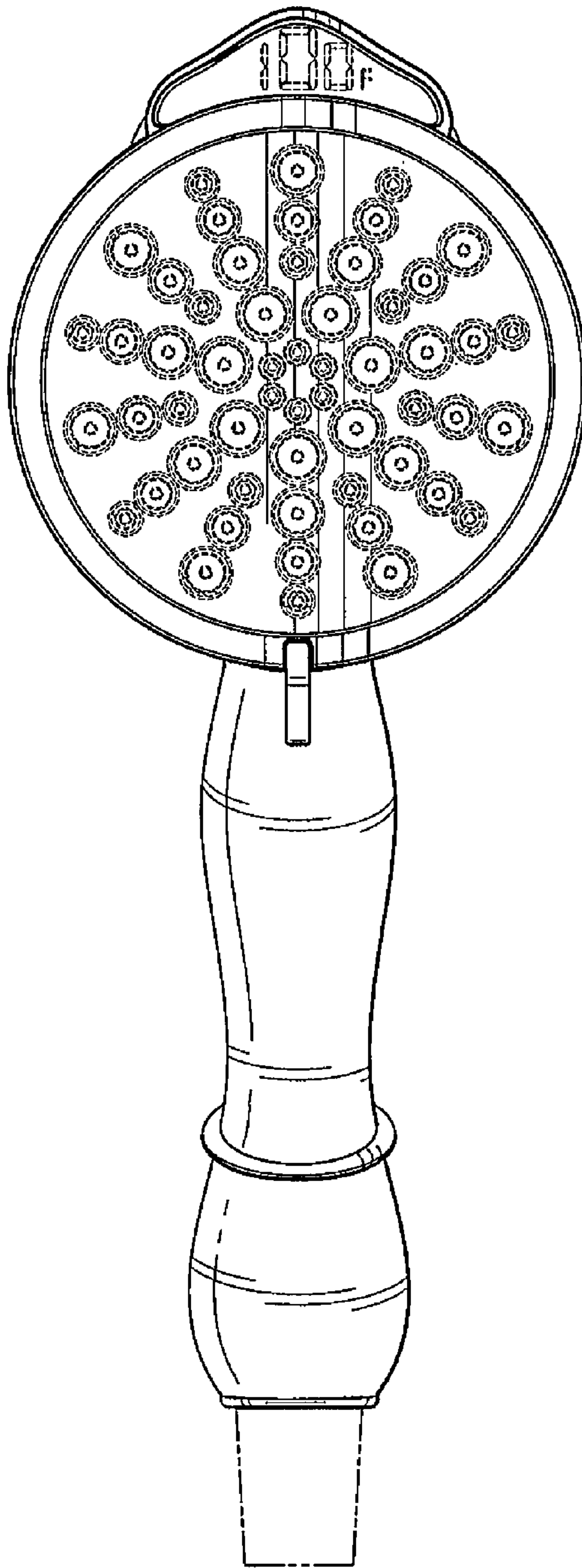

Fig-4

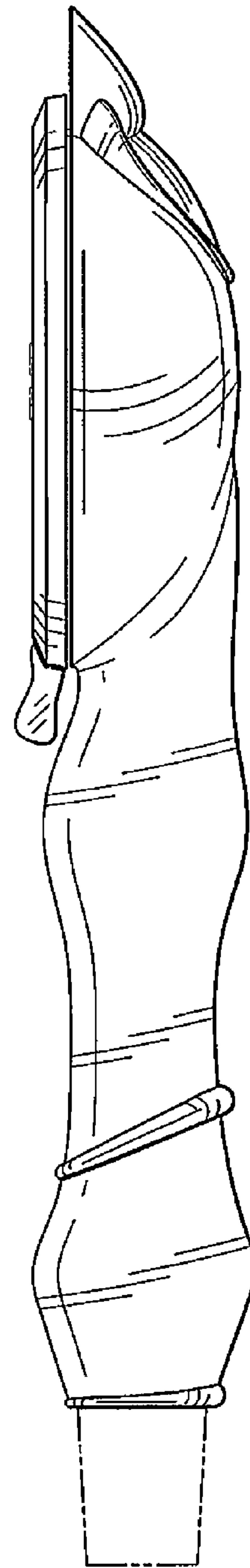

Fig-5

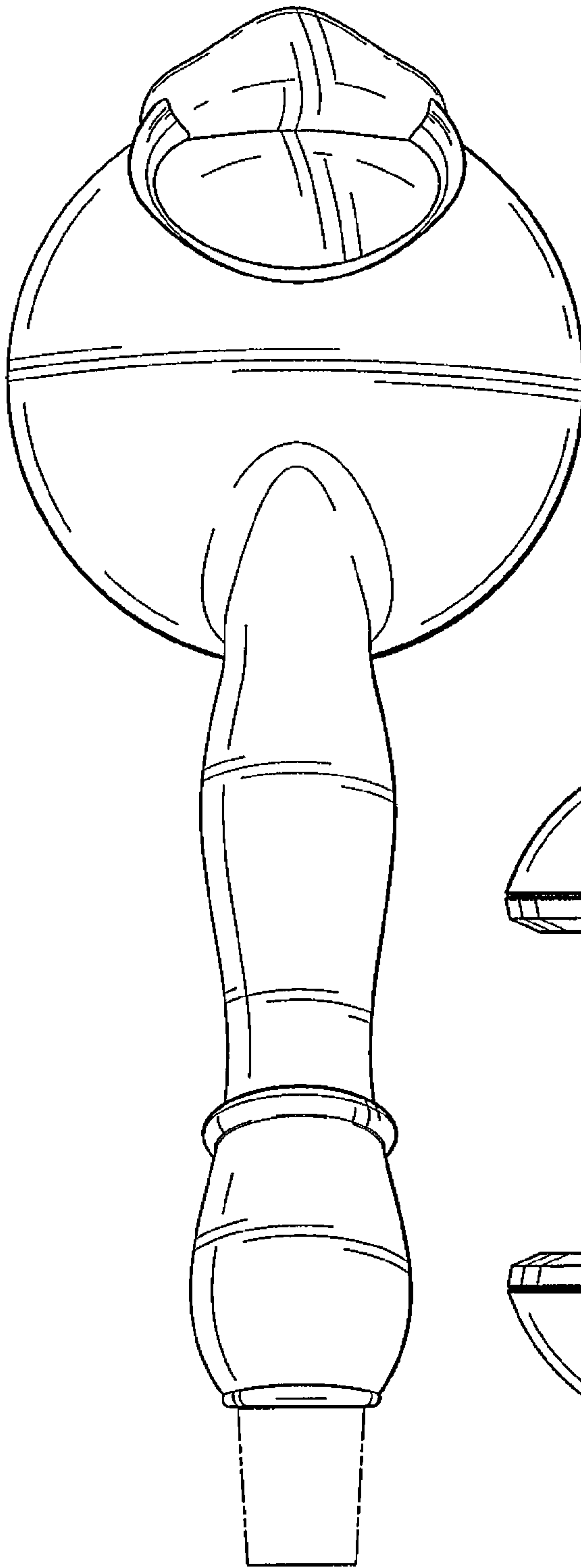

Fig-6

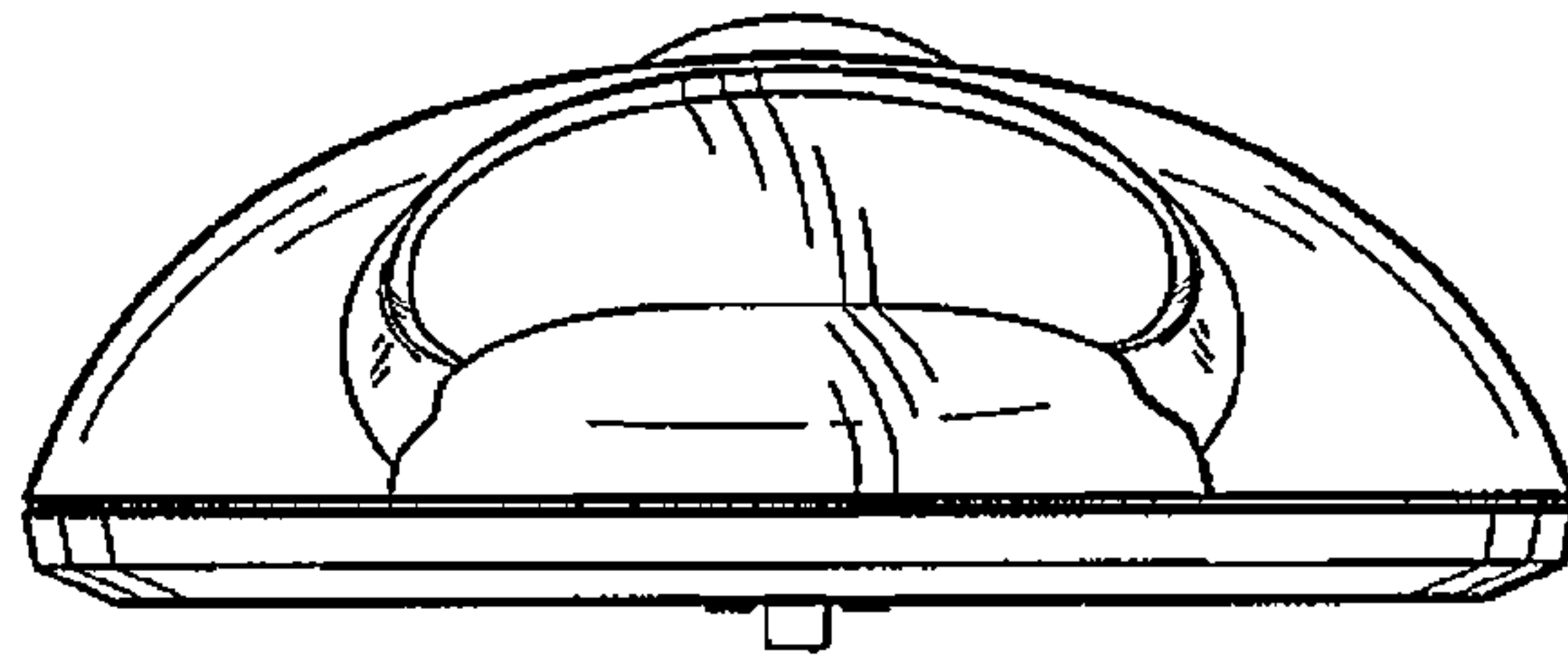

Fig-7

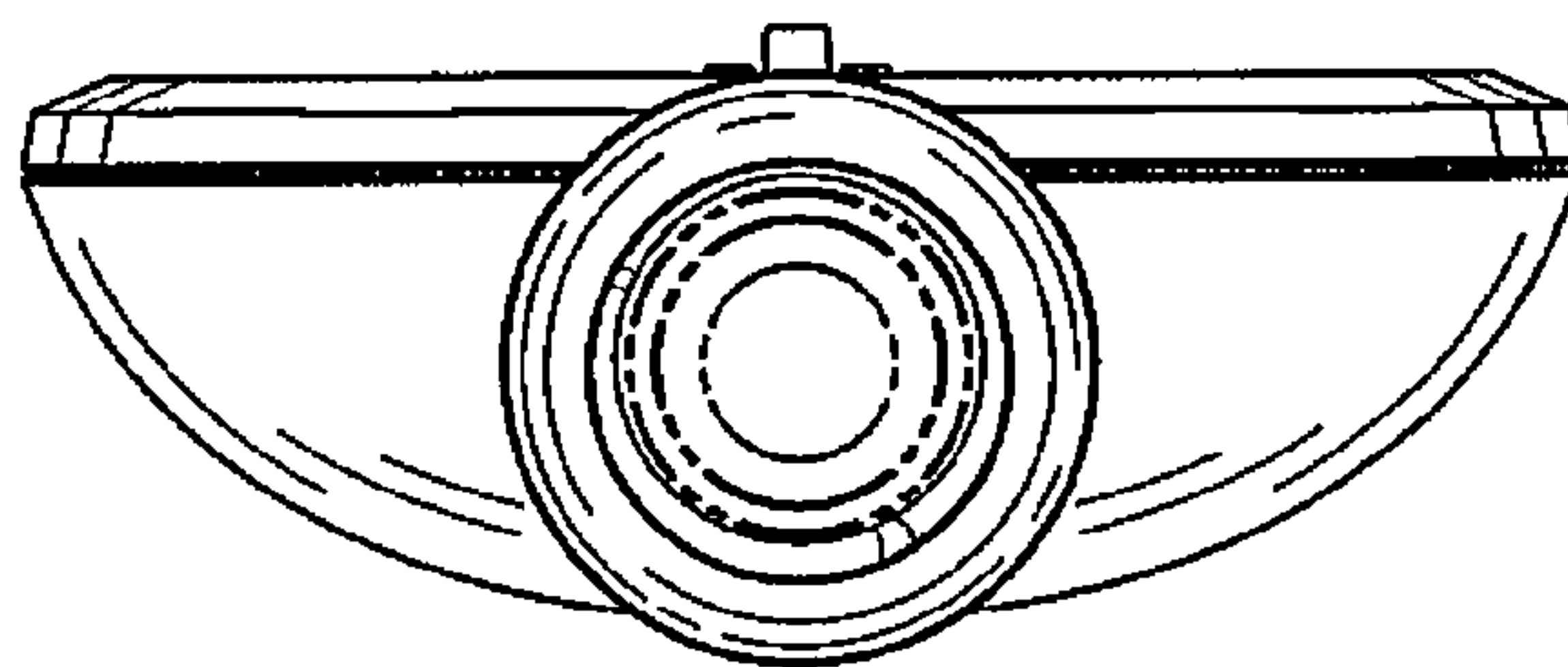

Fig-8