



US00D701289S

(12) **United States Design Patent**
Andrew

(10) **Patent No.:** **US D701,289 S**
(45) **Date of Patent:** **** Mar. 18, 2014**

(54) **SHOWERHEAD**

(71) Applicant: **Masco Corporation of Indiana,**
Indianapolis, IN (US)

(72) Inventor: **Mercedita Andrew,** Indianapolis, IN
(US)

(73) Assignee: **Masco Corporation of Indiana,**
Indianapolis, IN (US)

(**) Term: **14 Years**

(21) Appl. No.: **29/444,787**

(22) Filed: **Feb. 4, 2013**

(51) **LOC (10) Cl.** **23-01**

(52) **U.S. Cl.**
USPC **D23/213**

(58) **Field of Classification Search**
USPC D23/213, 223, 226, 229, 230; 239/282,
239/283; 4/615

See application file for complete search history.

(56) **References Cited**

U.S. PATENT DOCUMENTS

D453,550 S * 2/2002 Lobermeier D23/228
D503,463 S * 3/2005 Hughes et al. D23/229

D515,661 S * 2/2006 Hughes et al. D23/213
D577,793 S * 9/2008 Leber D23/213
D578,181 S * 10/2008 Pan D23/213
D626,194 S * 10/2010 Kakihana et al. D23/213

* cited by examiner

Primary Examiner — Robin V Webster

(74) *Attorney, Agent, or Firm* — Edgar A. Zarins; Nirav D. Parikh

(57) **CLAIM**

The ornamental design for a showerhead, as shown and described.

DESCRIPTION

FIG. 1 is a perspective view of a showerhead showing my new design;

FIG. 2 is a front elevational view thereof;

FIG. 3 is a left side view thereof;

FIG. 4 is a rear view thereof;

FIG. 5 is a right side view thereof;

FIG. 6 is a top end view thereof; and,

FIG. 7 is a bottom end view thereof.

The broken line showing is included for the purpose of illustrating and forms no part of the claimed design.

1 Claim, 4 Drawing Sheets

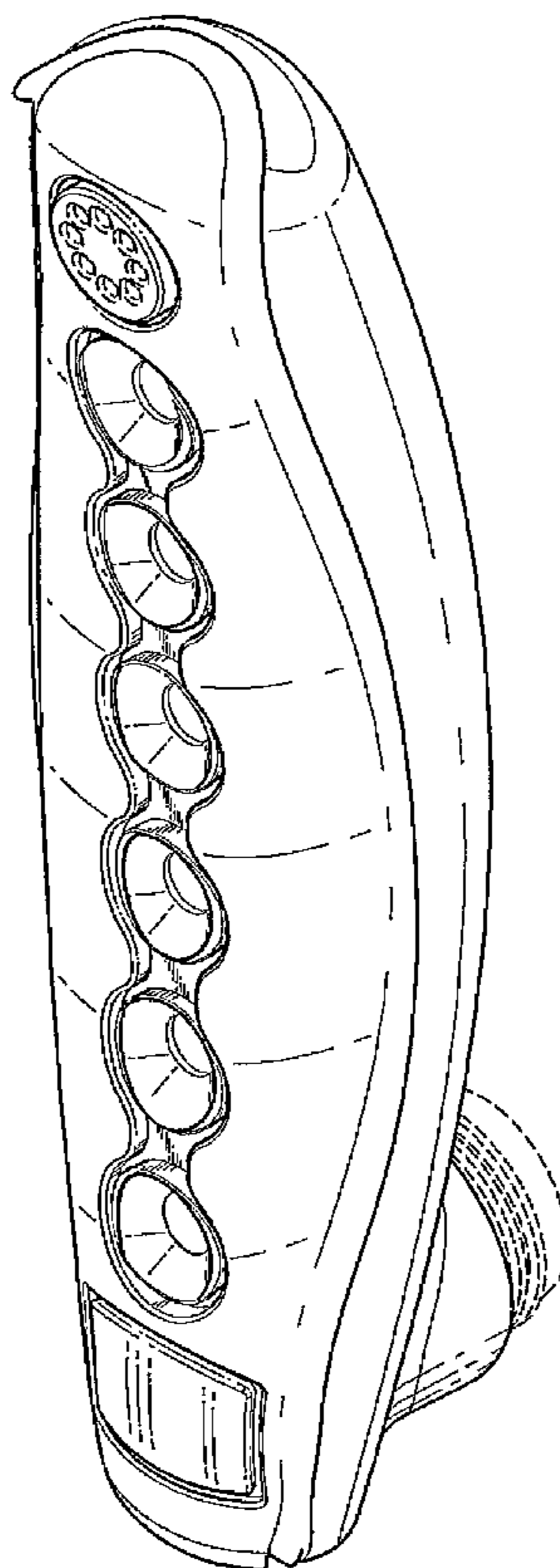

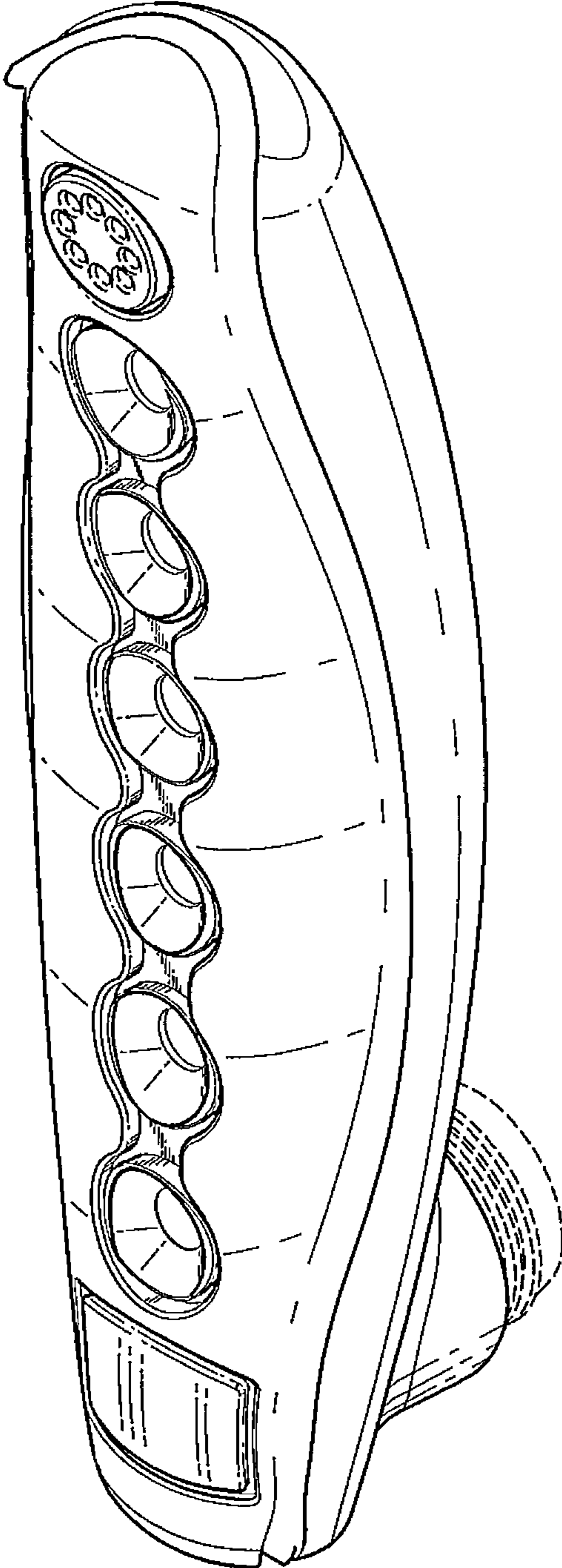

Fig-1

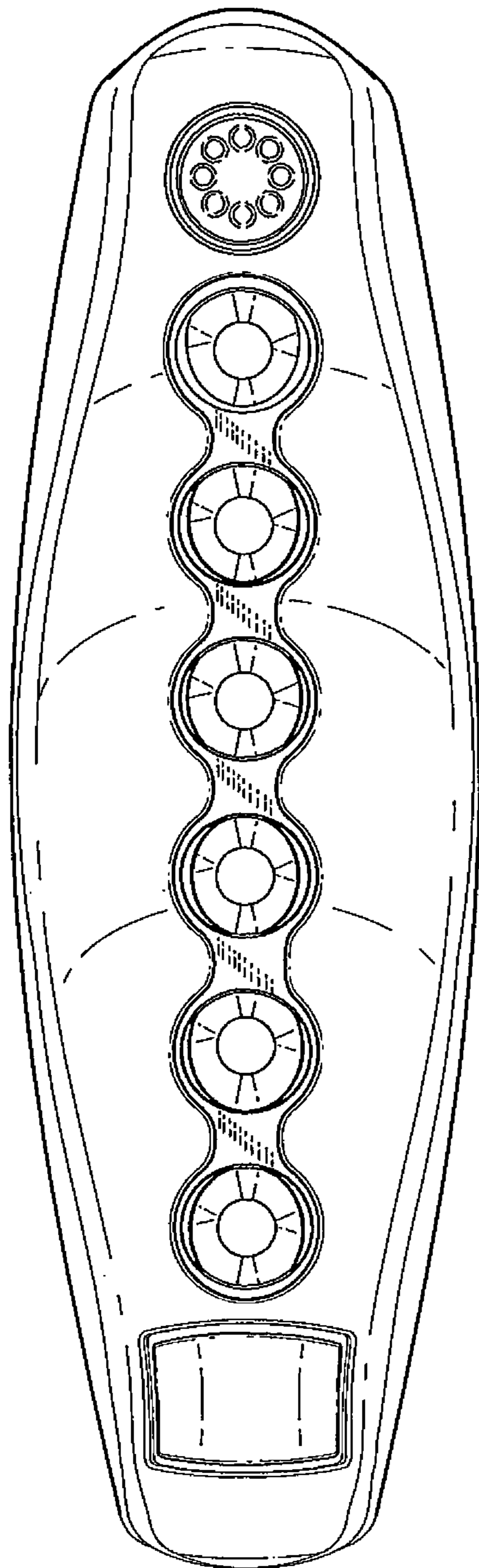

Fig-2

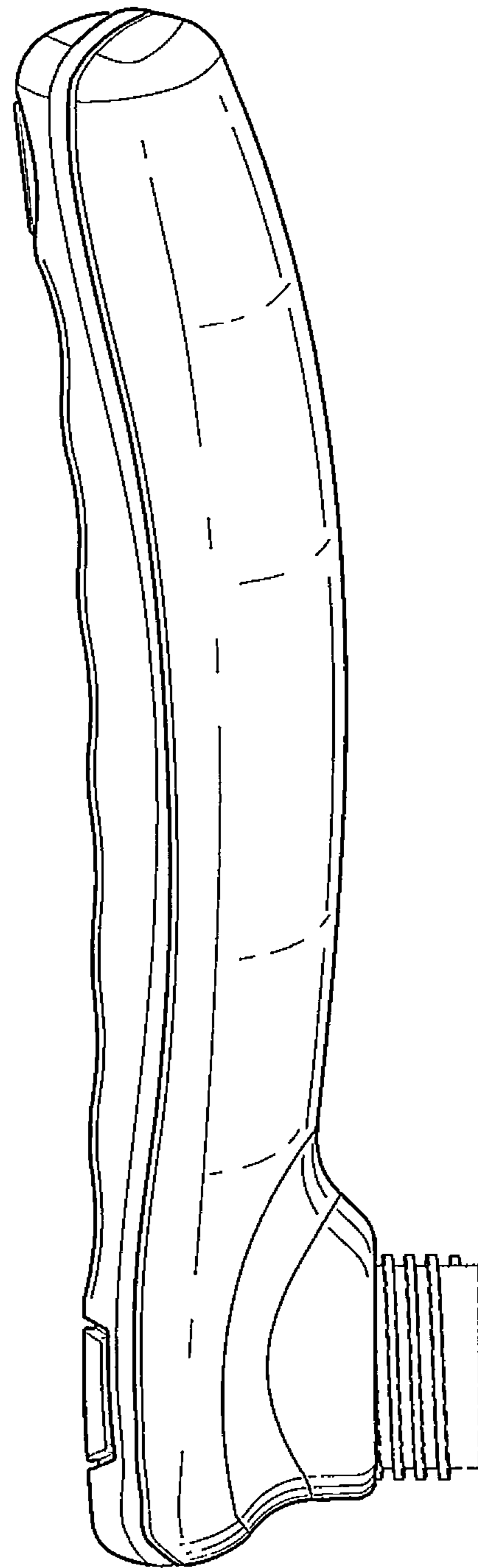

Fig-3

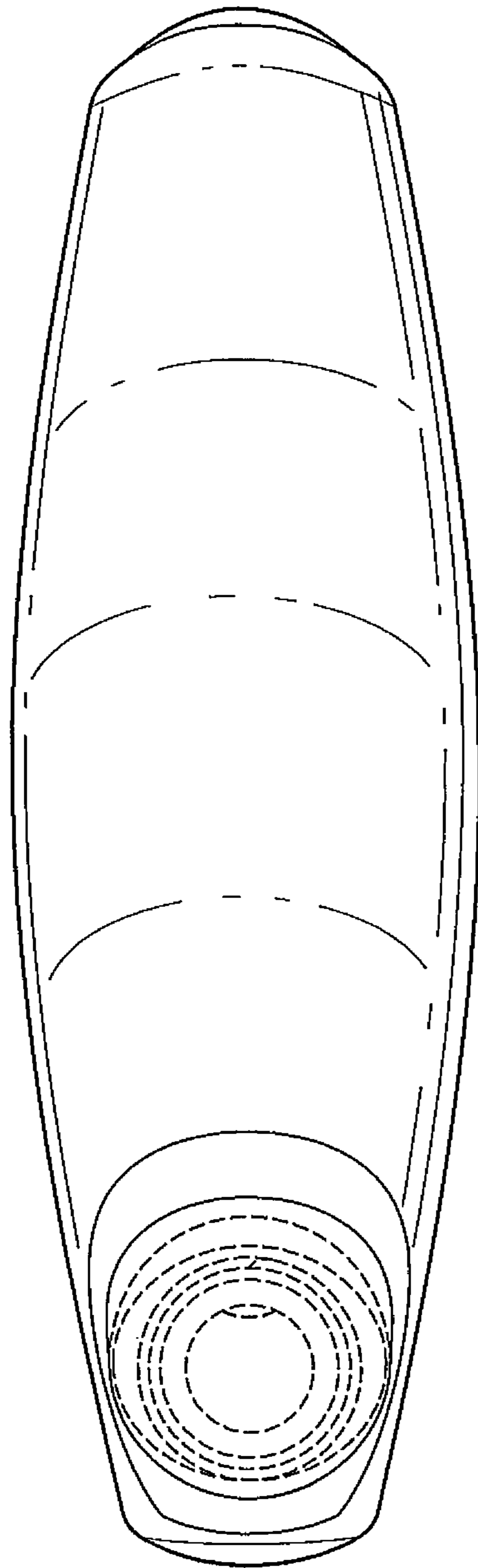

Fig-4

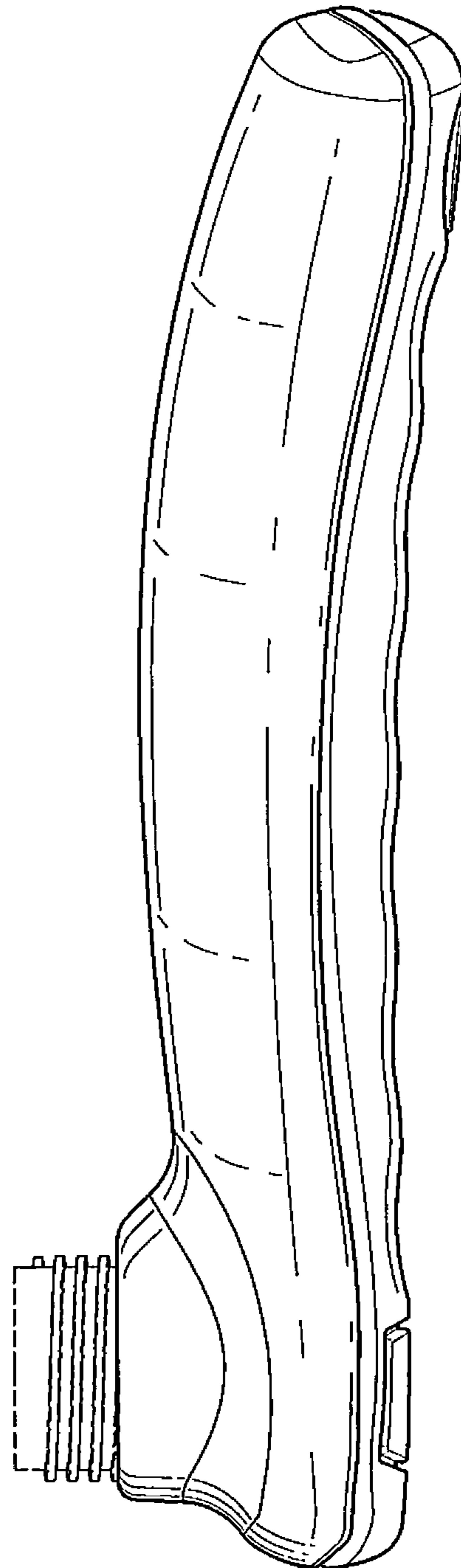

Fig-5

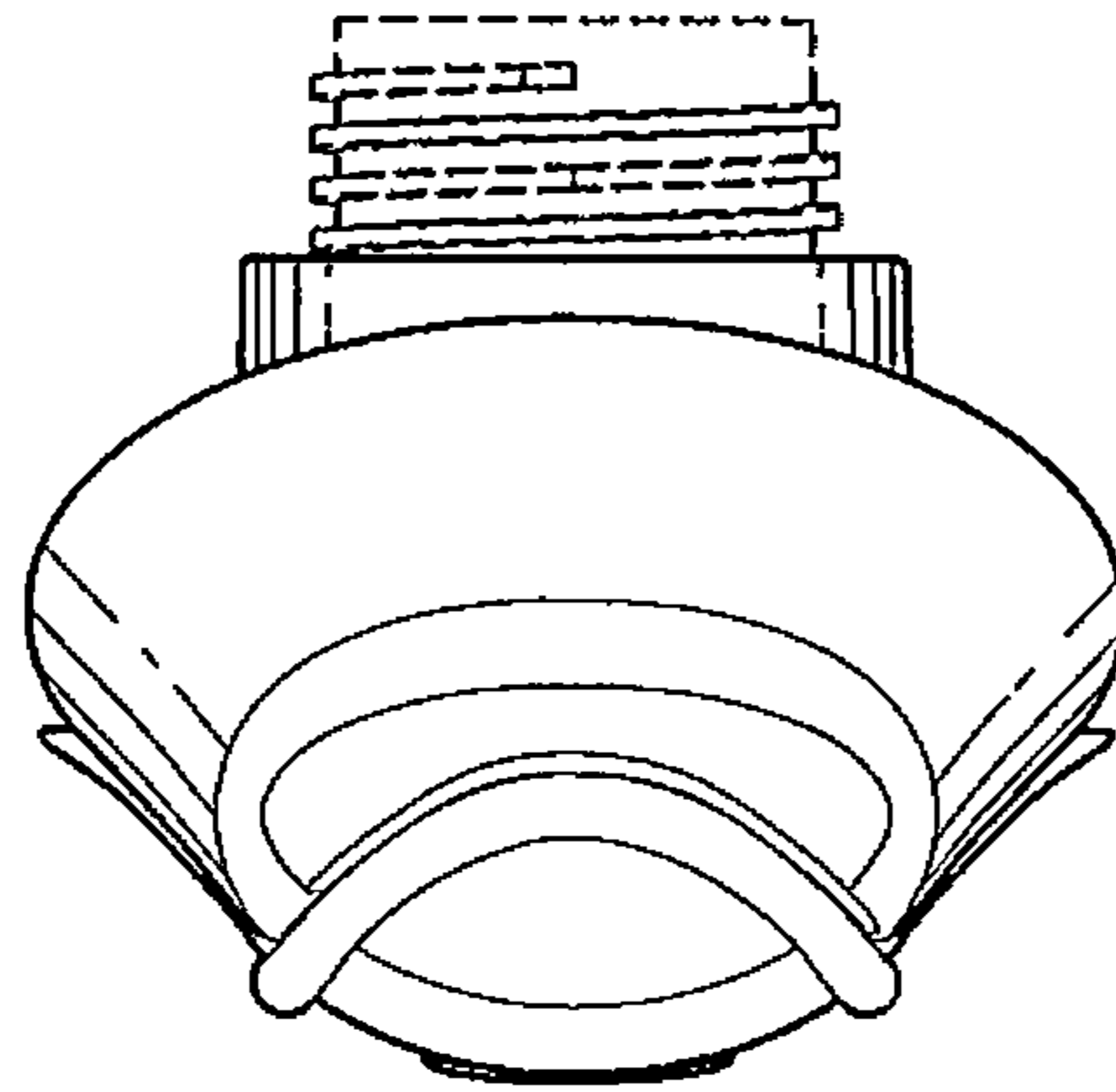

Fig-6

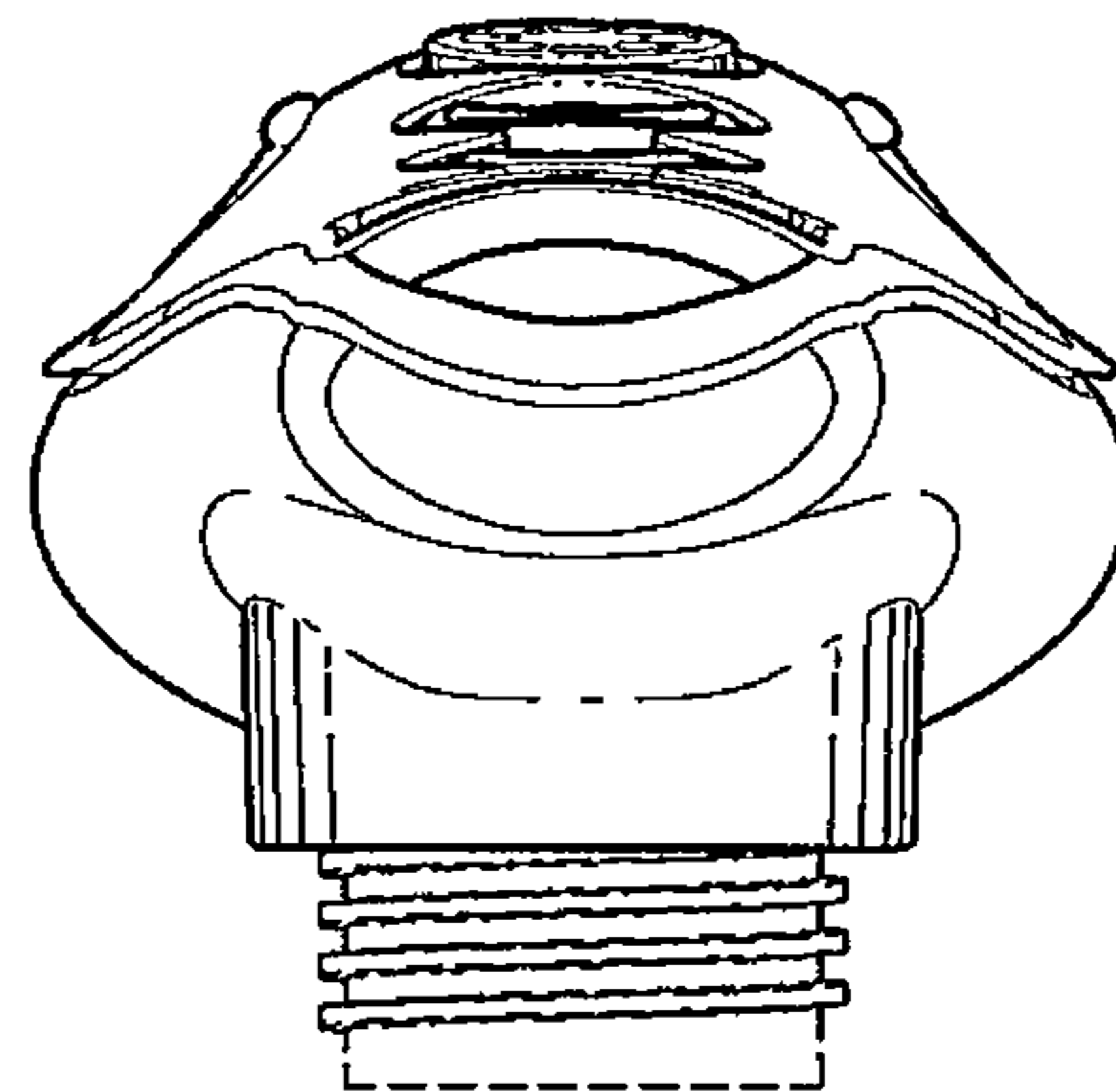

Fig-7