



US00D701109S

(12) **United States Design Patent**
Kelleghan

(10) **Patent No.:** **US D701,109 S**

(45) **Date of Patent:** **** Mar. 18, 2014**

(54) **LONG-ARMED MAN SHAPED CLIP**

(71) Applicant: **Bison Designs, LLC**, Longmont, CO
(US)

(72) Inventor: **Brian James Kelleghan**, Longmont, CO
(US)

(73) Assignee: **Bison Designs, LLC**, Longmont, CO
(US)

(**) Term: **14 Years**

(21) Appl. No.: **29/461,743**

(22) Filed: **Jul. 26, 2013**

(51) **LOC (10) Cl.** **08-05**

(52) **U.S. Cl.**
USPC **D8/356**

(58) **Field of Classification Search**
USPC D8/367, 354, 349, 372; D6/323;
248/301-304, 339, 205.3, 217.2, 493,
248/215; 294/16, 82.18; 138/106; D23/200;
160/349.2; 223/106; 411/431, 372.5
See application file for complete search history.

(56) **References Cited**

U.S. PATENT DOCUMENTS

25,082 A	8/1859	Pollak	
180,174 A	7/1876	Timmens	
195,909 A	10/1877	Walker	
203,461 A	5/1879	Jones	
307,280 A	10/1884	Farmer	
437,380 A	9/1890	Lundborg	
547,877 A	10/1895	Covert	
582,780 A *	5/1897	Eldridge	24/582.11
D34,899 S	8/1901	Brockelbank	

947,764 A	1/1910	Schartow	
1,165,606 A	12/1915	King	
1,605,853 A	11/1926	O'Bannon	
1,709,235 A	4/1929	Shaffer	
D117,674 S *	11/1939	Lewis	D8/372
D216,008 S *	11/1969	Dennison	D8/370

(Continued)

Primary Examiner — Cynthia Underwood

(74) *Attorney, Agent, or Firm* — Margaret Polson; Oppedahl Patent Law Firm LLC

(57) **CLAIM**

The ornamental design for a long-armed man shaped clip, as shown and described.

DESCRIPTION

FIG. 1 is a front side elevation view of my new design for a long-armed man shaped clip.

FIG. 2 is a back side elevation view of FIG. 1.

FIG. 3 is a right side elevation view of FIG. 1.

FIG. 4 is a left side elevation view of FIG. 1.

FIG. 5 is a top side plan view of FIG. 1.

FIG. 6 is a bottom side plan view of FIG. 1.

FIG. 7 is front perspective view of FIG. 1.

FIG. 8 is a front side elevation view of my new design for a long-armed man shaped clip.

FIG. 9 is a back side elevation view of FIG. 8.

FIG. 10 is a right side elevation view of FIG. 8.

FIG. 11 is a left side elevation view of FIG. 8.

FIG. 12 is a top side plan view of FIG. 8.

FIG. 13 is a bottom side plan view of FIG. 8; and,

FIG. 14 is front perspective view of FIG. 8.

The features shown in broken lines in the drawing depict environmental subject matter only and form no part of the claimed design.

1 Claim, 2 Drawing Sheets

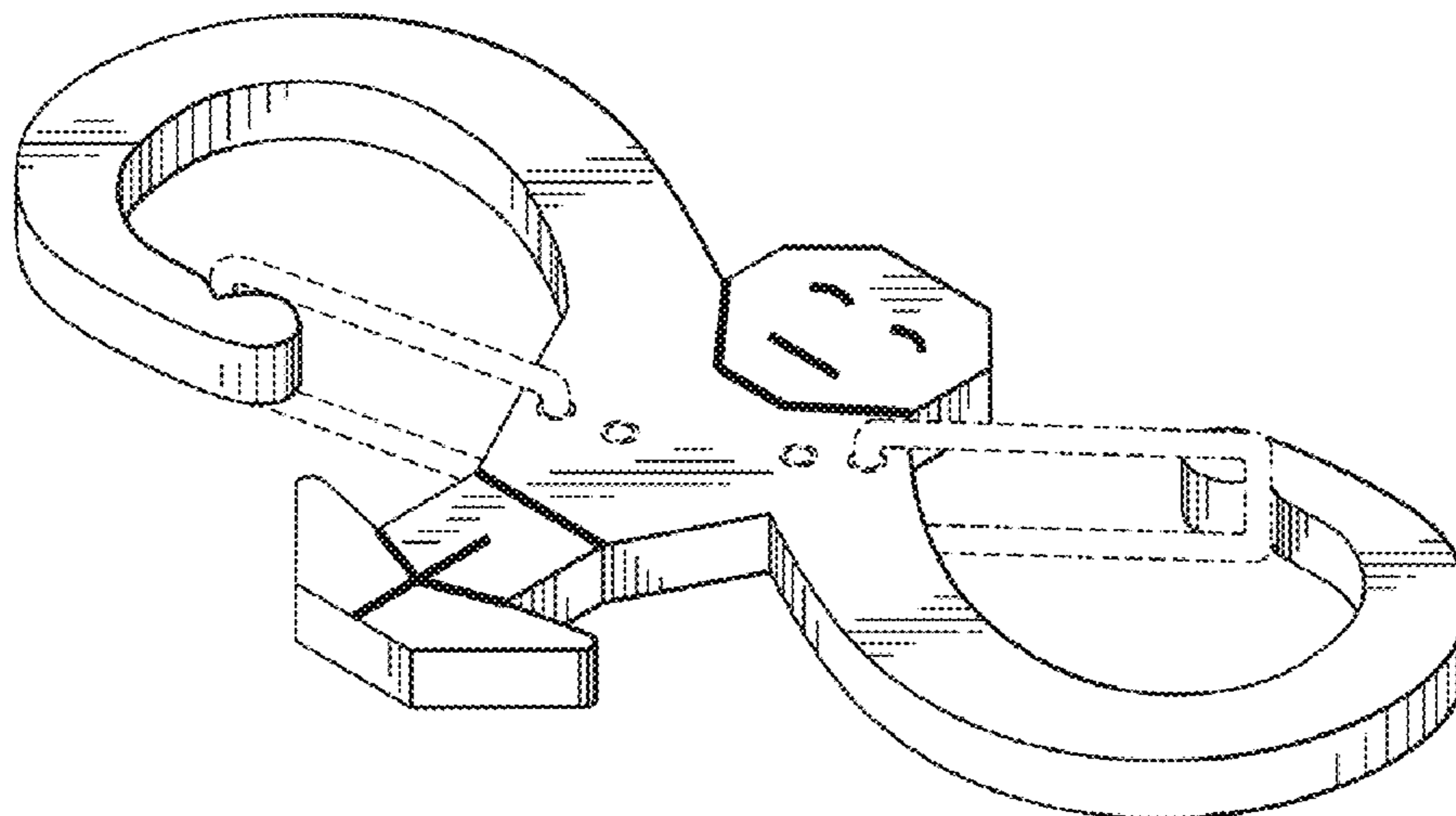

(56)

References Cited

U.S. PATENT DOCUMENTS

D269,882 S *	7/1983	Leverton	D19/59	D603,293 S	11/2009	Merriam-Smith	
D292,385 S	10/1987	Udelhofen		D607,712 S *	1/2010	Kelleghan	D8/356
D323,104 S	1/1992	Russell et al.		D612,710 S	3/2010	Kelleghan	
5,913,479 A	6/1999	Westwood, III		D626,393 S	11/2010	Ormsbee	
6,682,032 B1 *	1/2004	Bradlee	248/215	D637,473 S *	5/2011	Mitchell	D8/336
D492,188 S	6/2004	Goldberg		D646,556 S *	10/2011	Kelleghan	D8/356
D532,707 S *	11/2006	Mombauer	D10/8	D669,527 S *	10/2012	Hammer et al.	D19/34.5
7,214,171 B2 *	5/2007	Thelen et al.	482/124	D669,764 S *	10/2012	Kelleghan	D8/356
D553,196 S *	10/2007	Canon	D20/31	D671,602 S *	11/2012	Bradford	D21/621
D568,407 S *	5/2008	Francis	D20/43	D683,617 S *	6/2013	Krumpe	D8/402
D577,574 S *	9/2008	Liang	D8/367	D687,673 S *	8/2013	Lin	D7/394
D594,738 S *	6/2009	Kelleghan	D8/356	D688,656 S *	8/2013	Avrahami	D14/253
				2007/0113450 A1 *	5/2007	Santa Cruz et al.	40/608
				2009/0000086 A1 *	1/2009	Bing	24/592.11

* cited by examiner

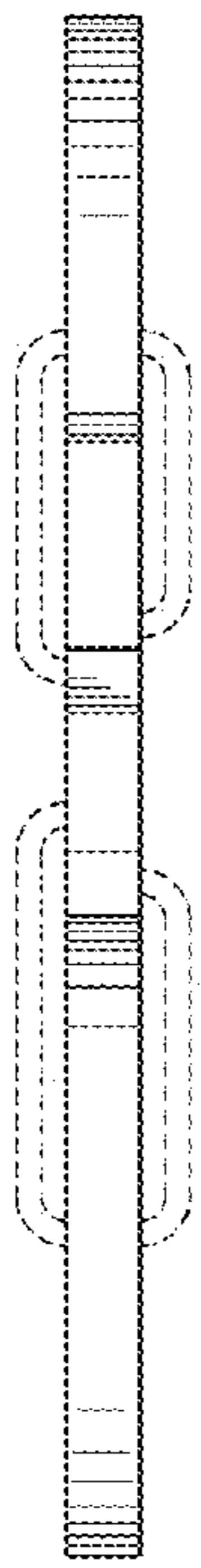

FIG. 5

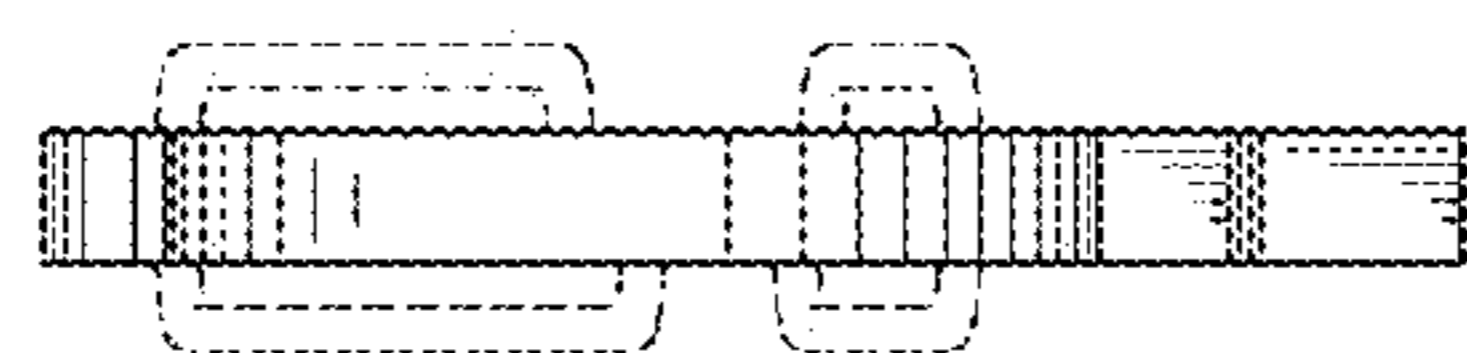

FIG. 3

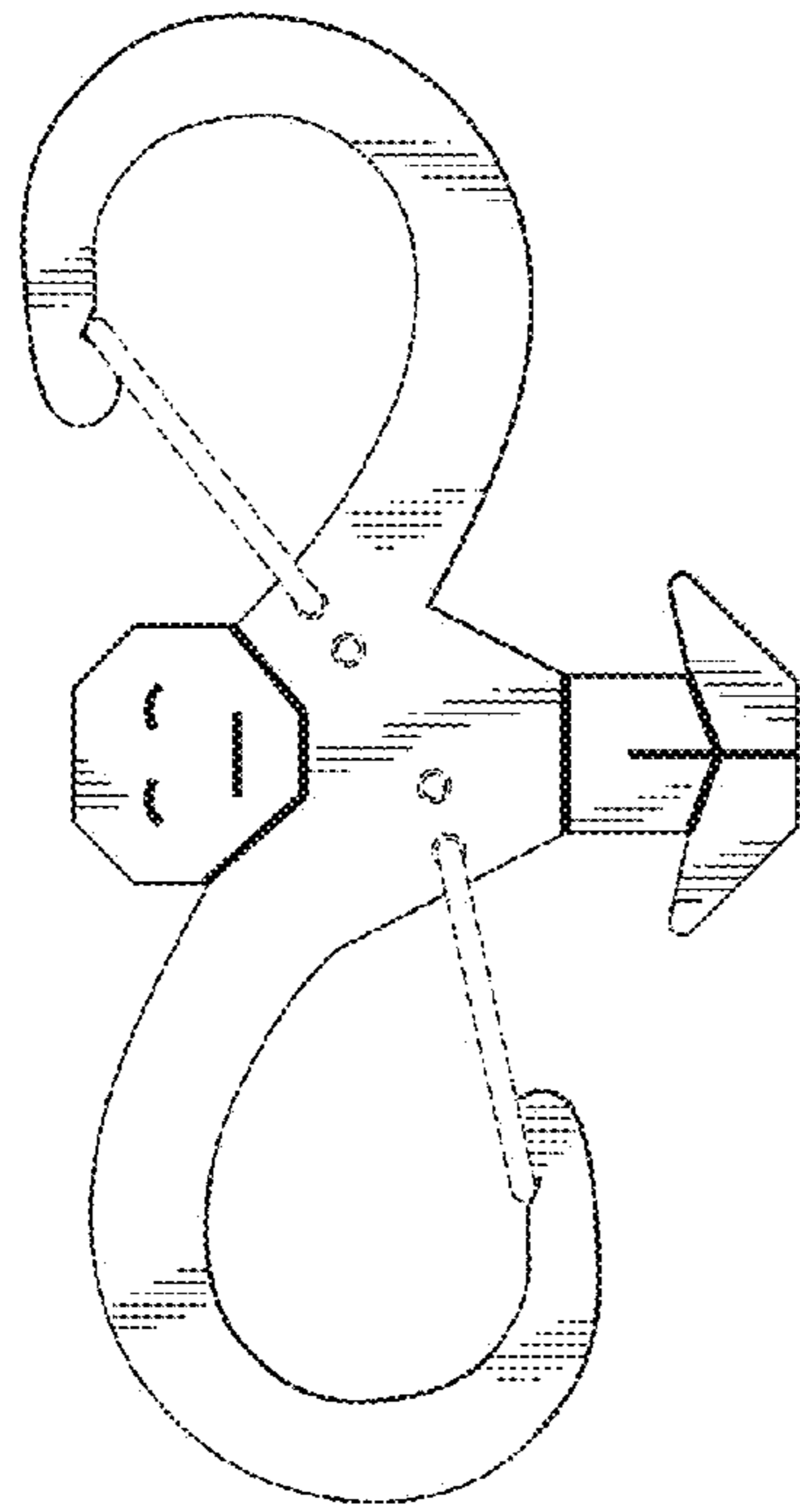

FIG. 1

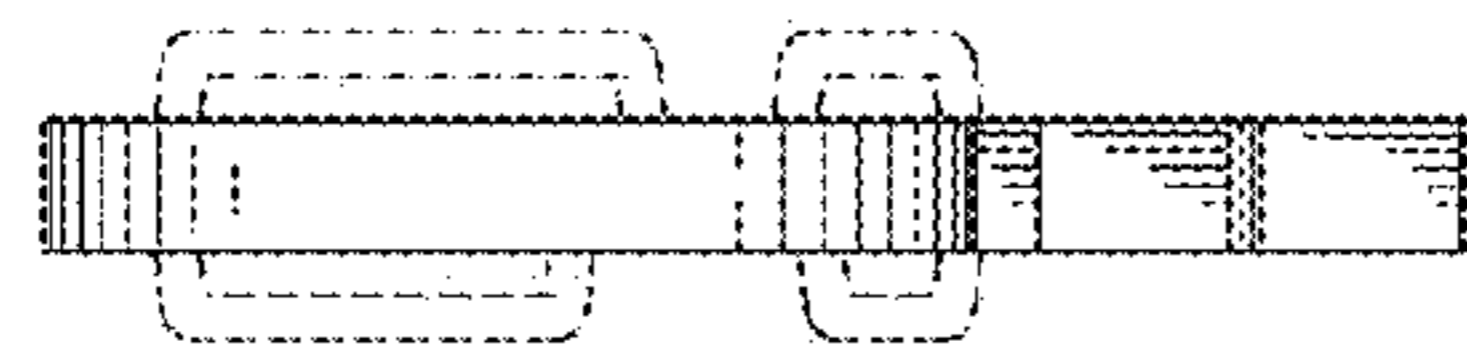

FIG. 4

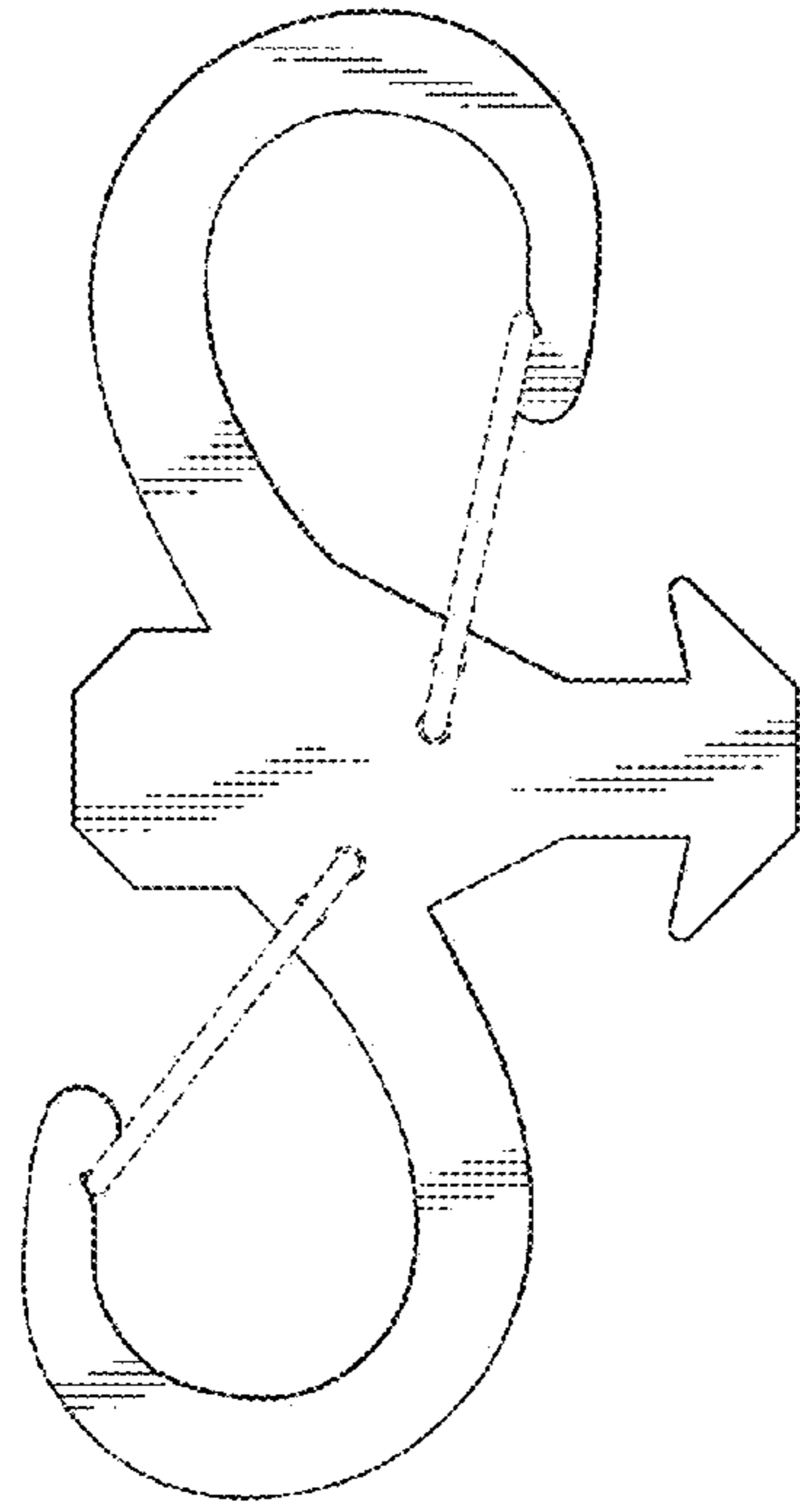

FIG. 2

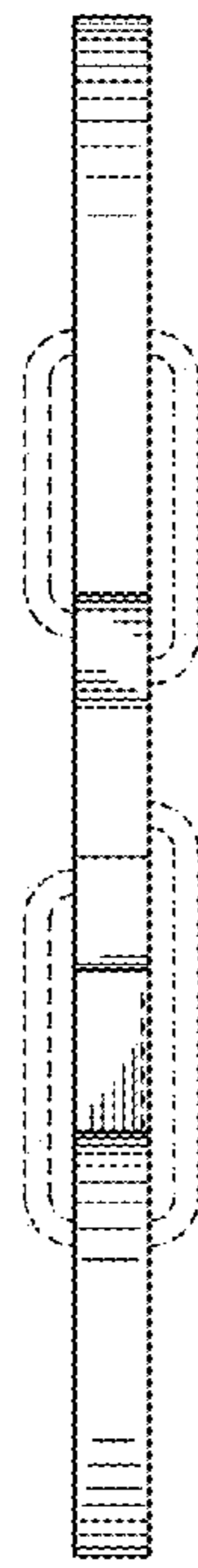

FIG. 6

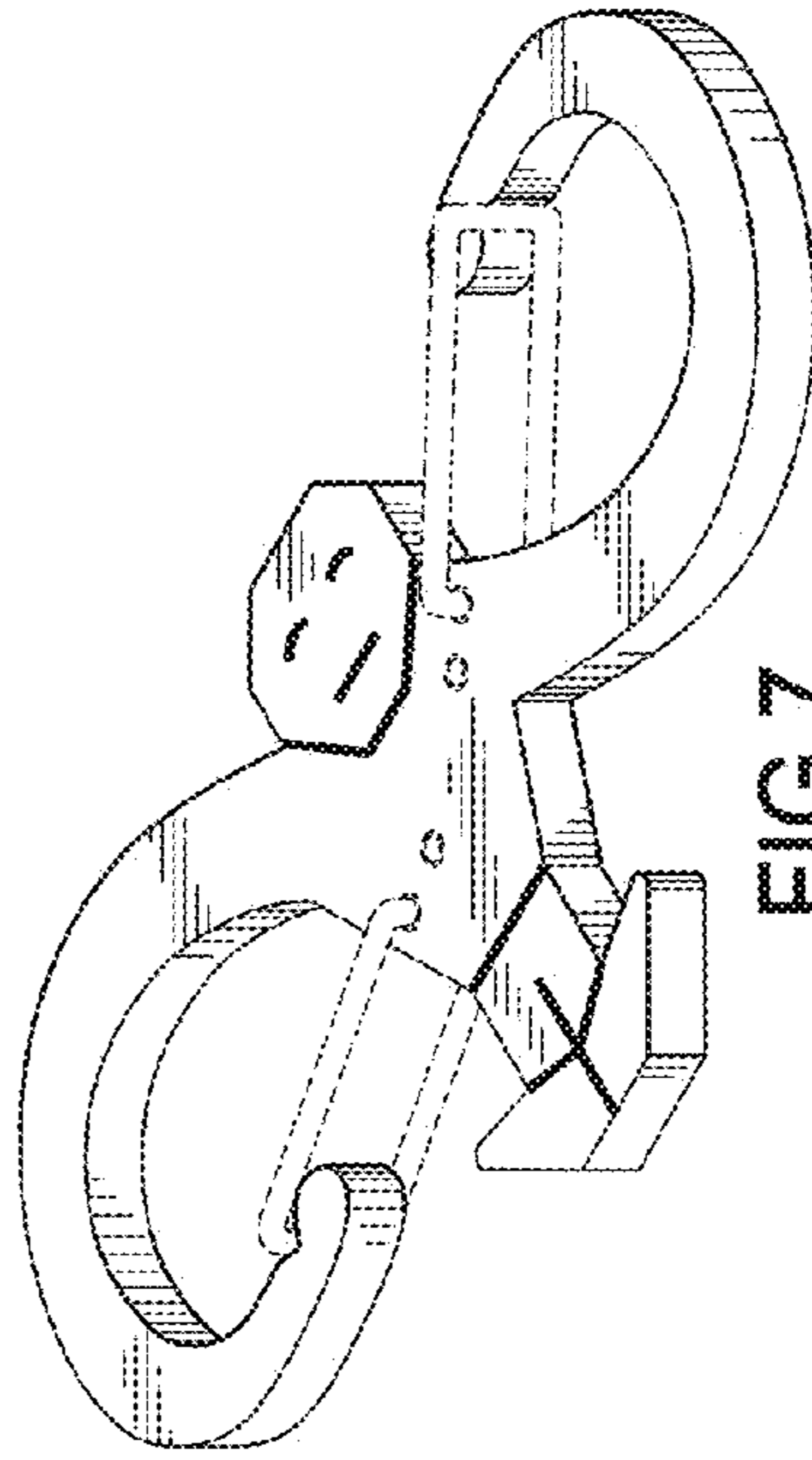

FIG. 7

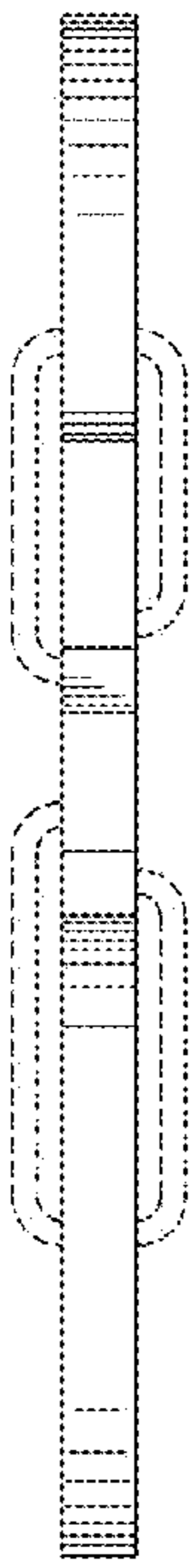

FIG. 12

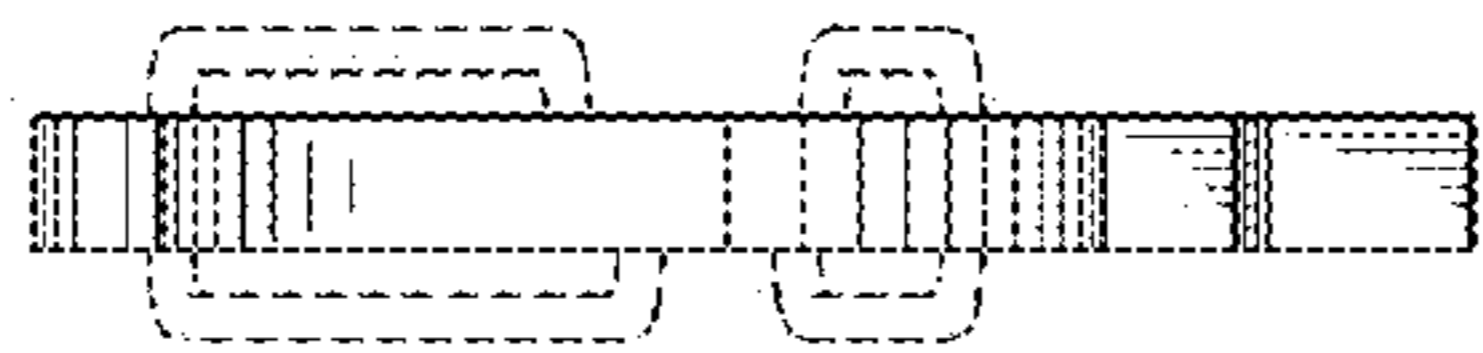

FIG. 10

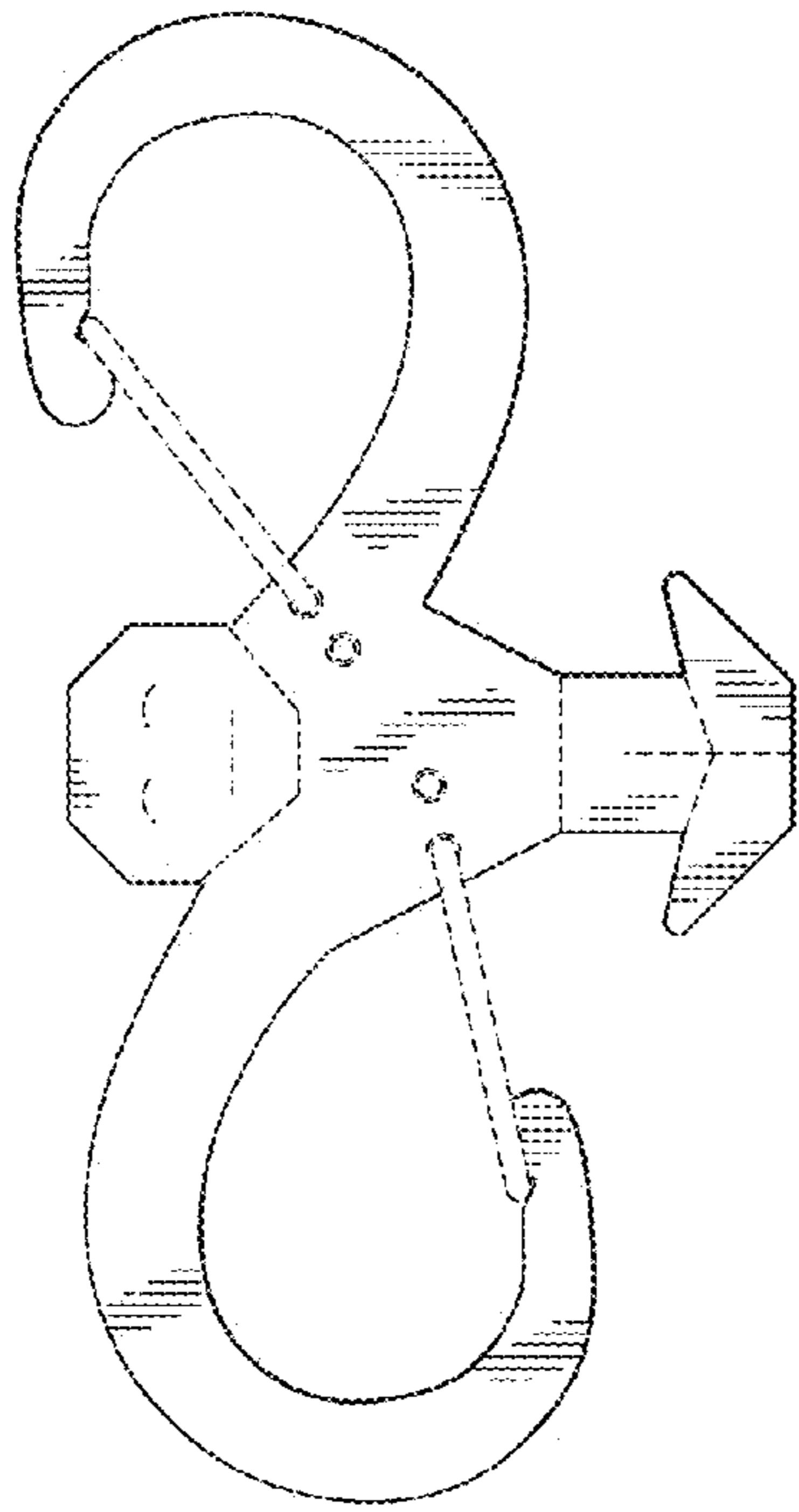

FIG. 8

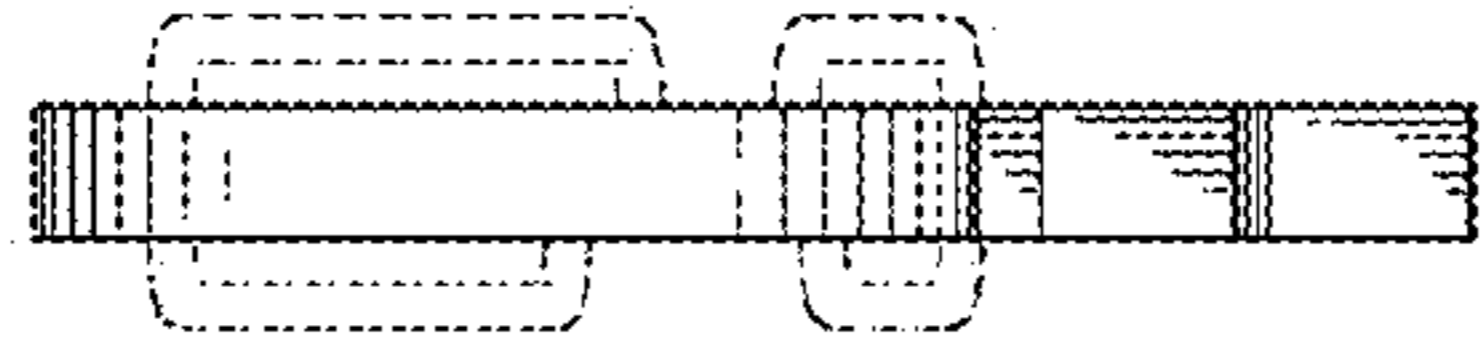

FIG. 11

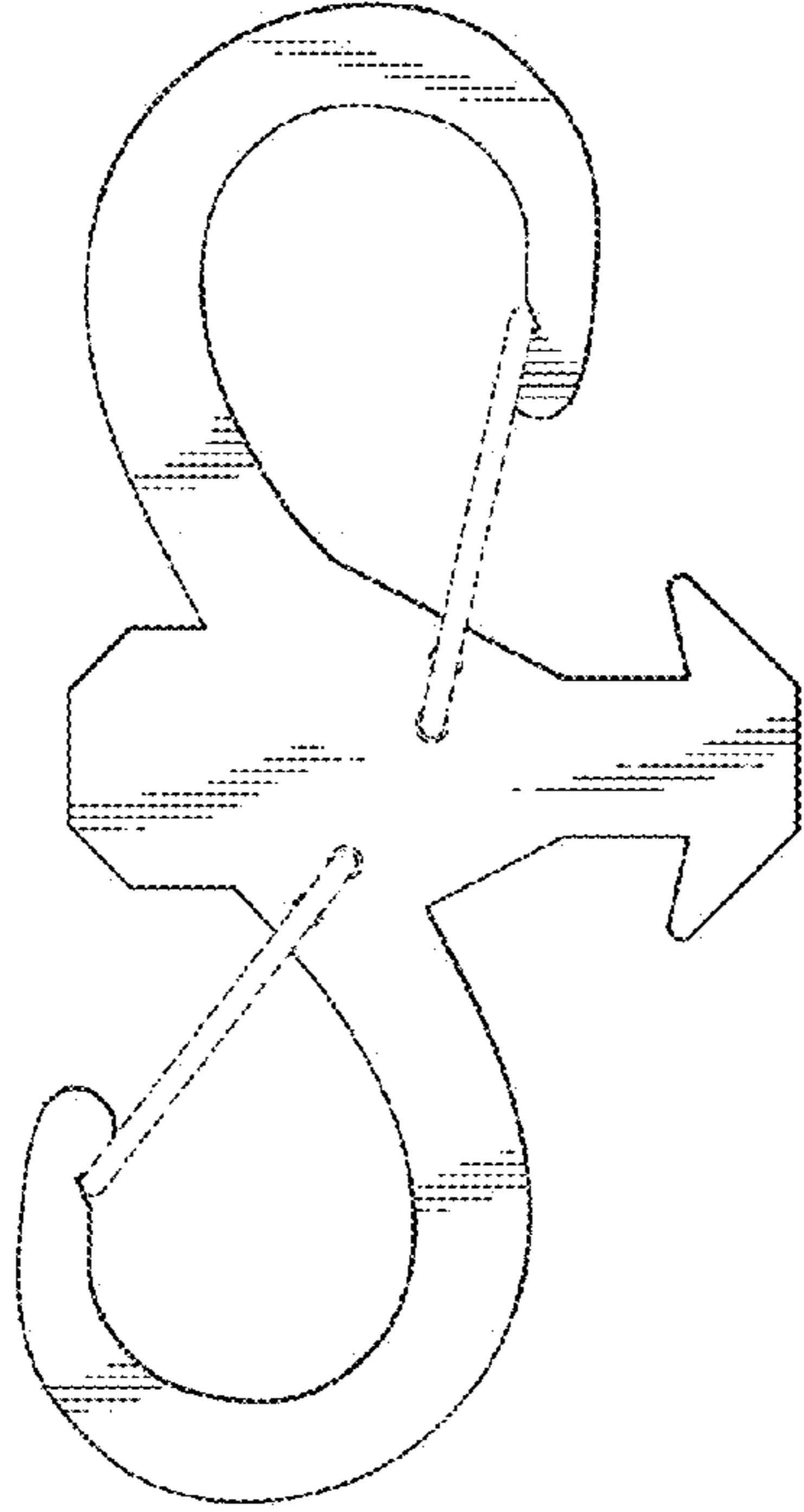

FIG. 9

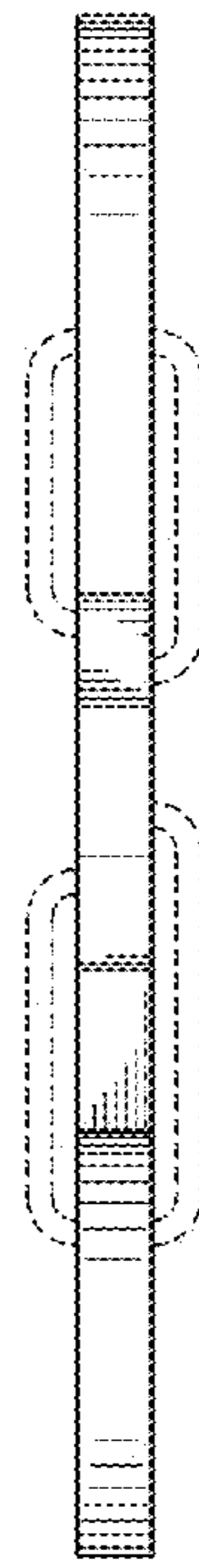

FIG. 13

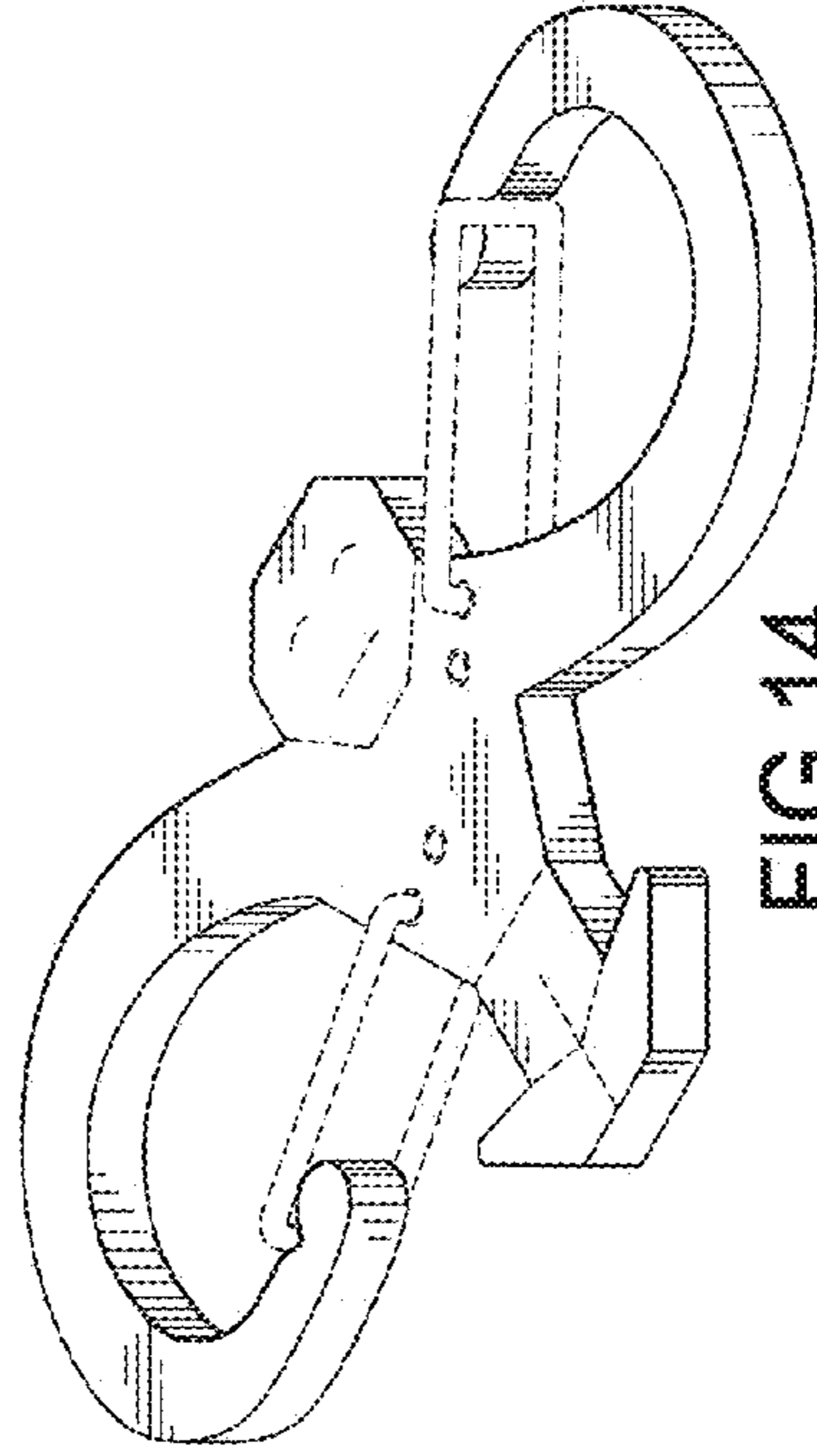

FIG. 14