



US00D701073S

(12) **United States Design Patent**
Liu

(10) **Patent No.:** **US D701,073 S**
(45) **Date of Patent:** **** Mar. 18, 2014**

(54) **WATER DISPENSER**

(75) Inventor: **Jian Liu**, Shenzhen (CN)

(73) Assignee: **Shenzhen Cocabo Water Equipment Co., Ltd.**, Shenzhen (CN)

(**) Term: **14 Years**

(21) Appl. No.: **29/426,475**

(22) Filed: **Jul. 6, 2012**

(51) **LOC (10) Cl.** **07-01**

(52) **U.S. Cl.**

USPC **D7/307; D7/308**

(58) **Field of Classification Search**

USPC D7/309-311, 300, 305, 306, 313, 307,
D7/308; 99/279, 284, 290, 275, 295, 293

See application file for complete search history.

(56) **References Cited**

U.S. PATENT DOCUMENTS

D90,806 S * 10/1933 Hendy D7/306
D312,021 S * 11/1990 Mohat D7/308
D346,088 S * 4/1994 Schroeder D7/307

D608,131 S * 1/2010 Meldrum et al. D7/307
D638,650 S * 5/2011 Galeazzi D7/309
D642,850 S * 8/2011 Yui D7/307
D645,289 S * 9/2011 Lenzi D7/309
D674,231 S * 1/2013 Wilder et al. D7/306

* cited by examiner

Primary Examiner — Marianne Pandozzi

(57) **CLAIM**

The ornamental design for a water dispenser, as shown and described.

DESCRIPTION

FIG. 1 is a front view of a water dispenser showing my new design;

FIG. 2 is a rear view thereof;

FIG. 3 is a left side view thereof;

FIG. 4 is a right side view thereof;

FIG. 5 is a top plan view thereof;

FIG. 6 is a bottom plan view thereof; and,

FIG. 7 is a front perspective view thereof.

The broken line portions of the drawings form no part of the claimed design.

1 Claim, 7 Drawing Sheets

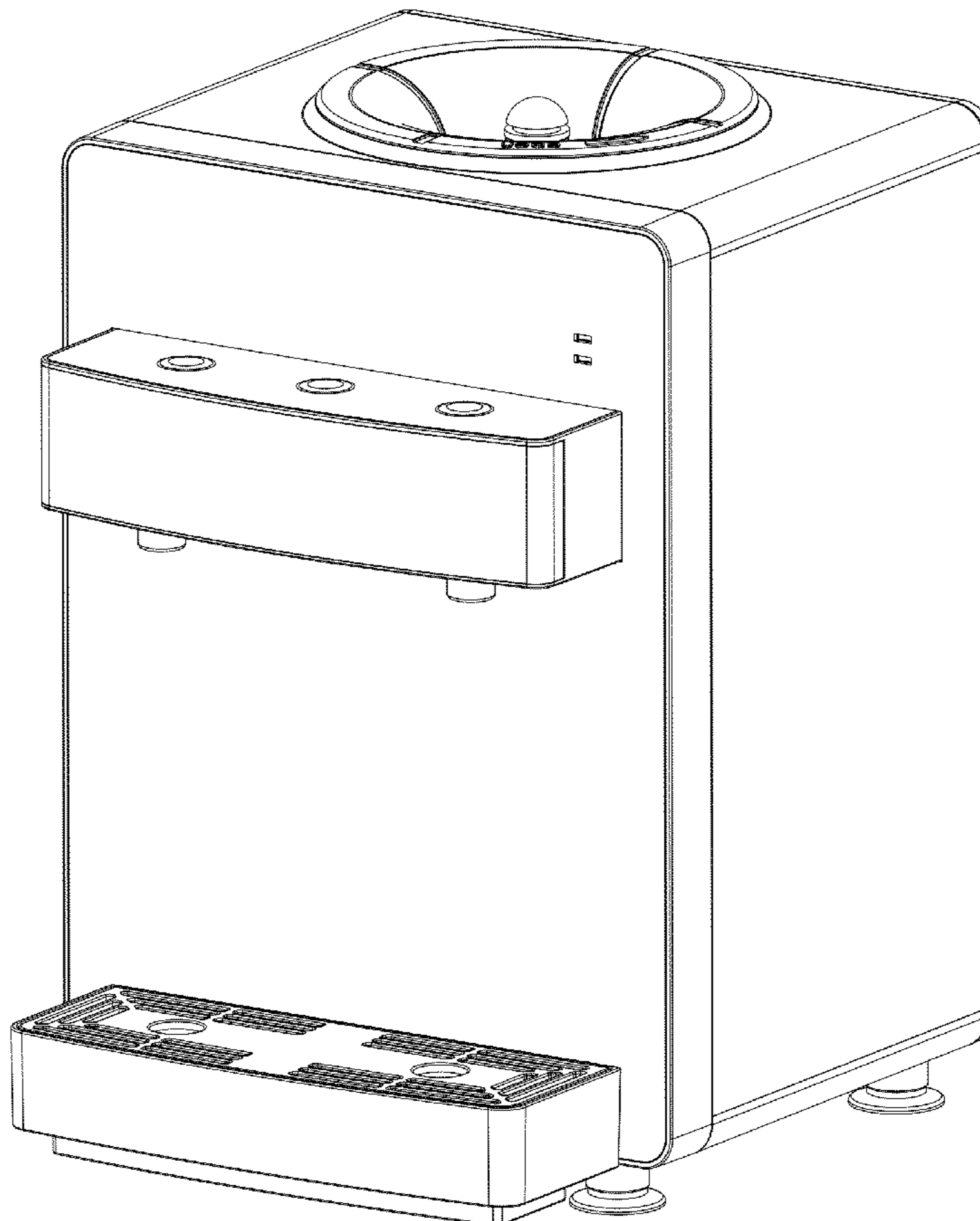

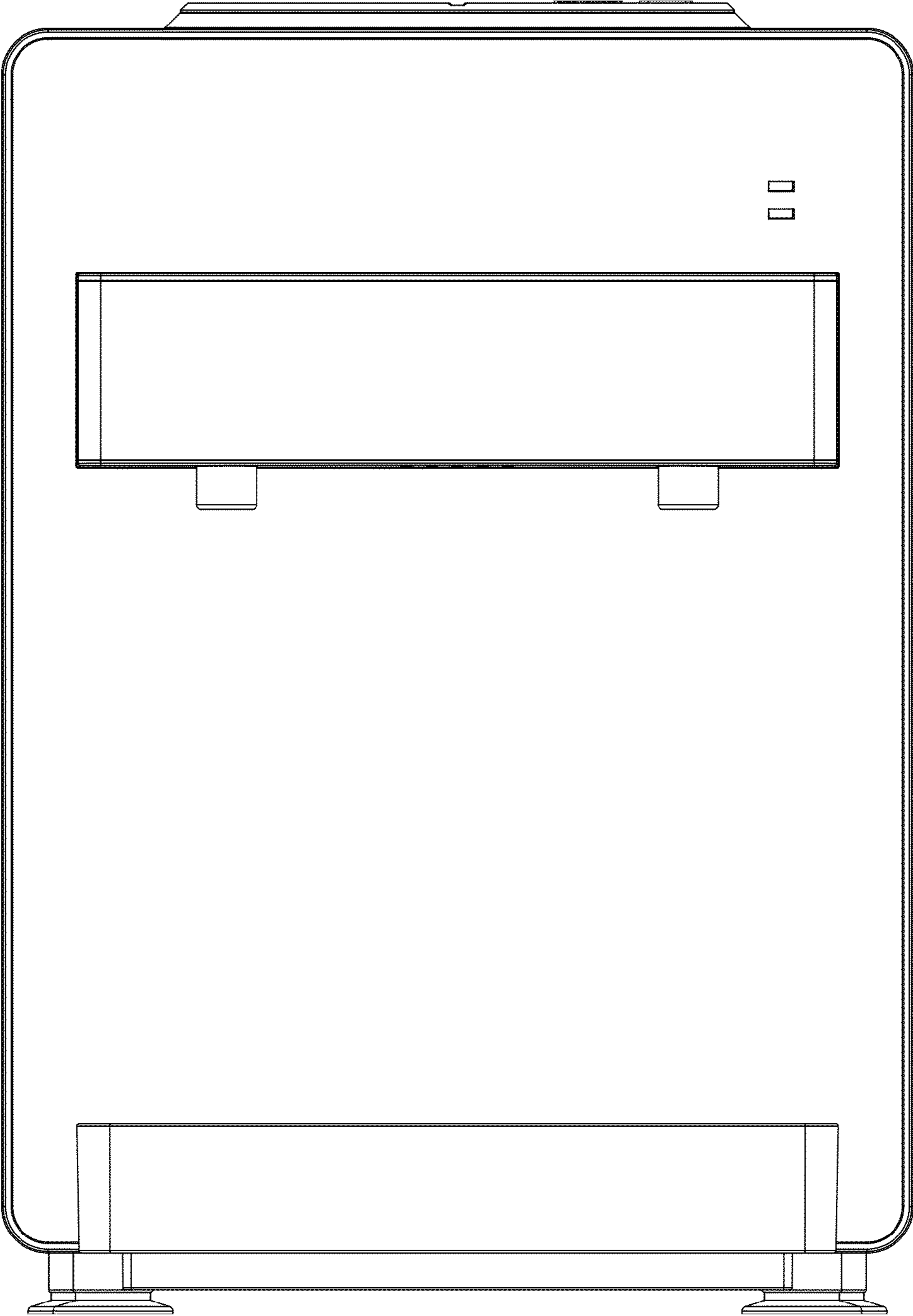

Fig. 1

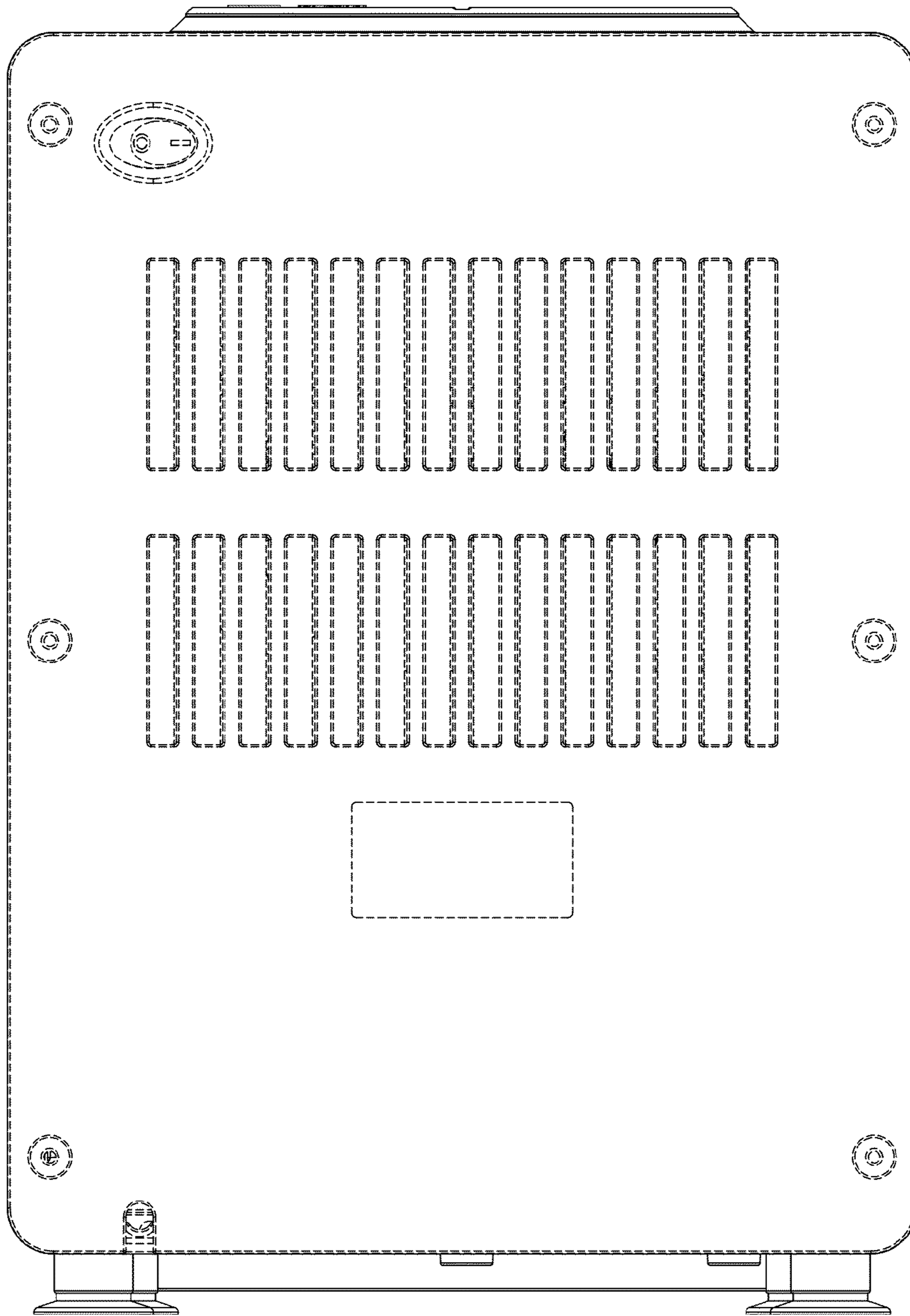

Fig. 2

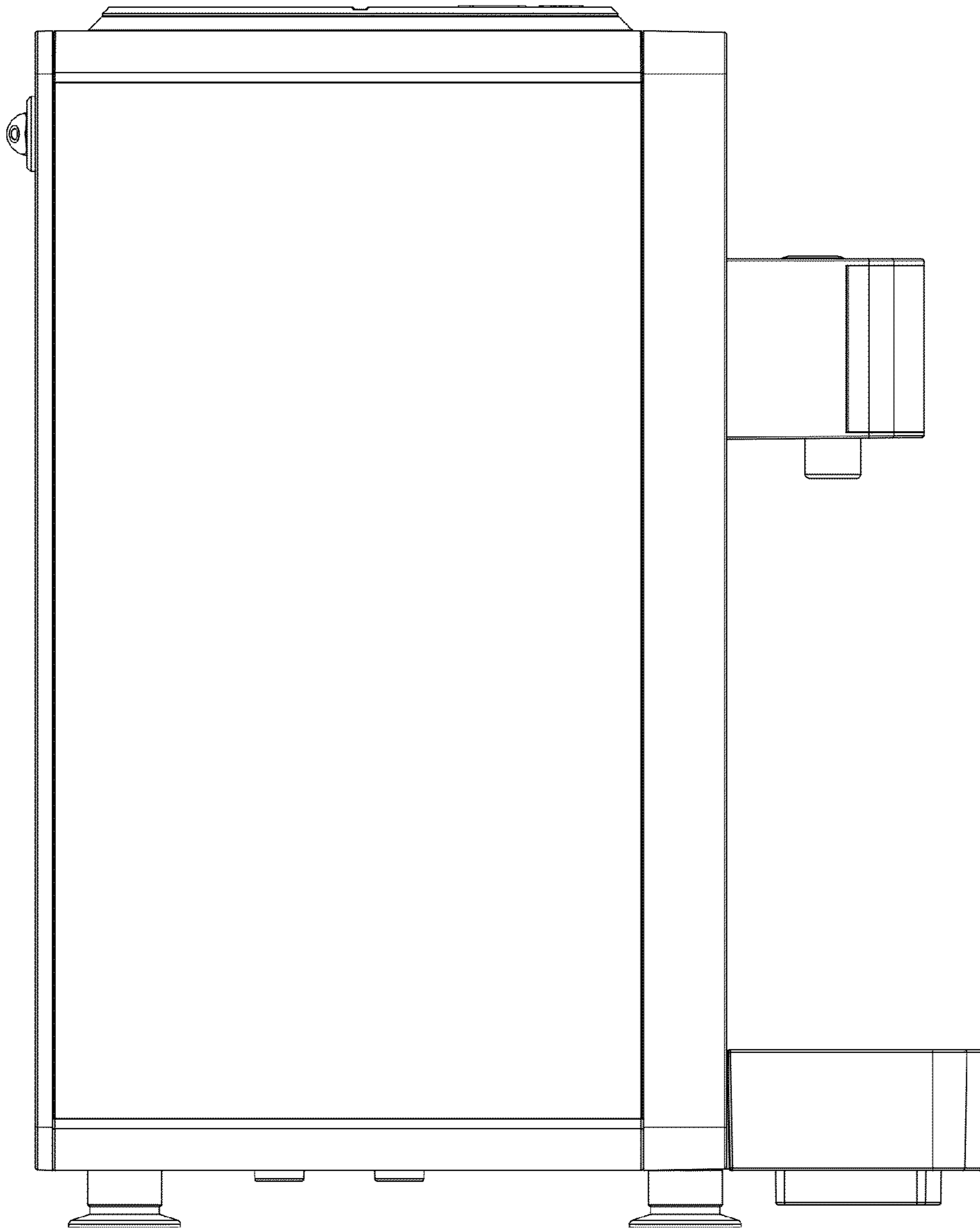

Fig. 3

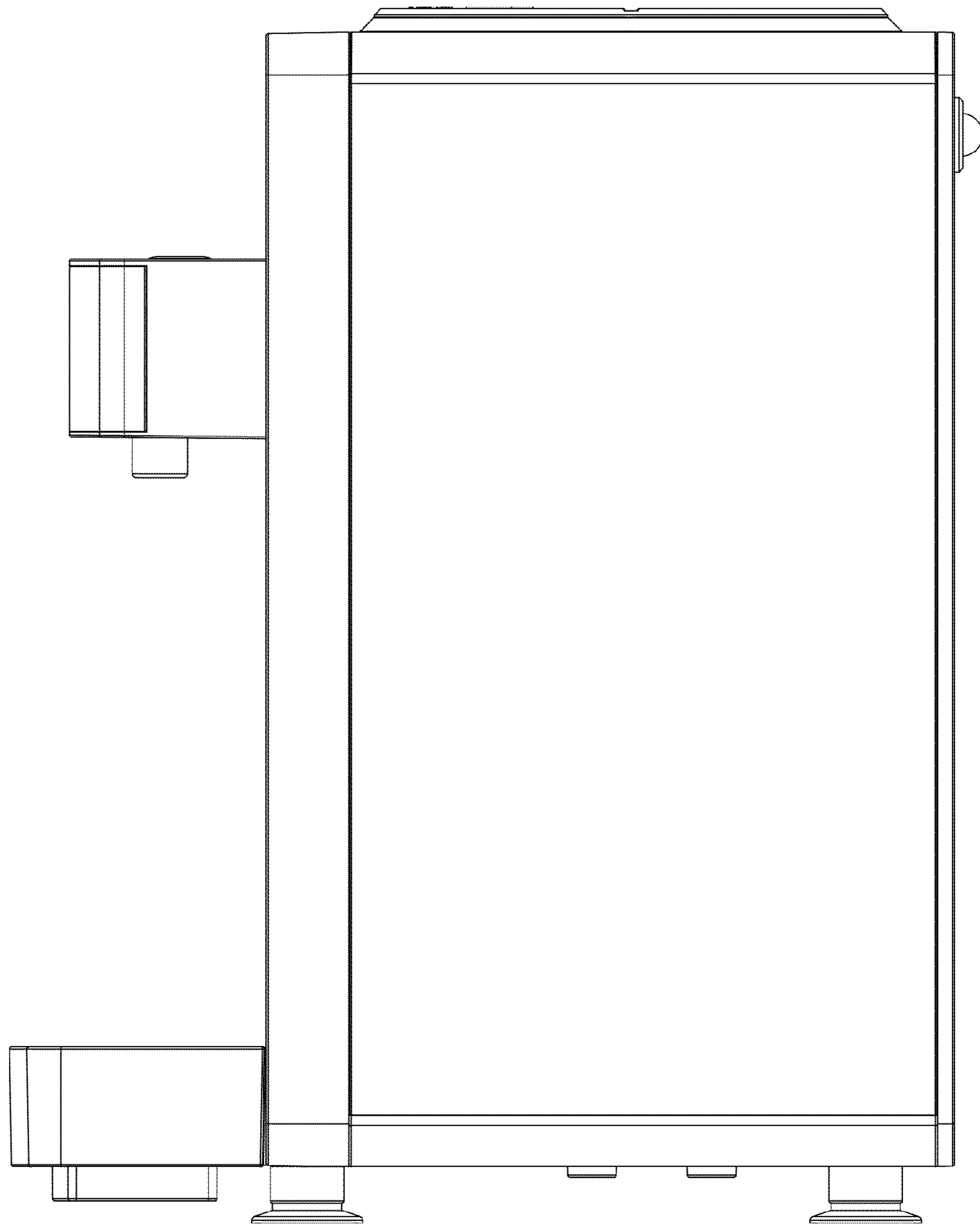

Fig. 4

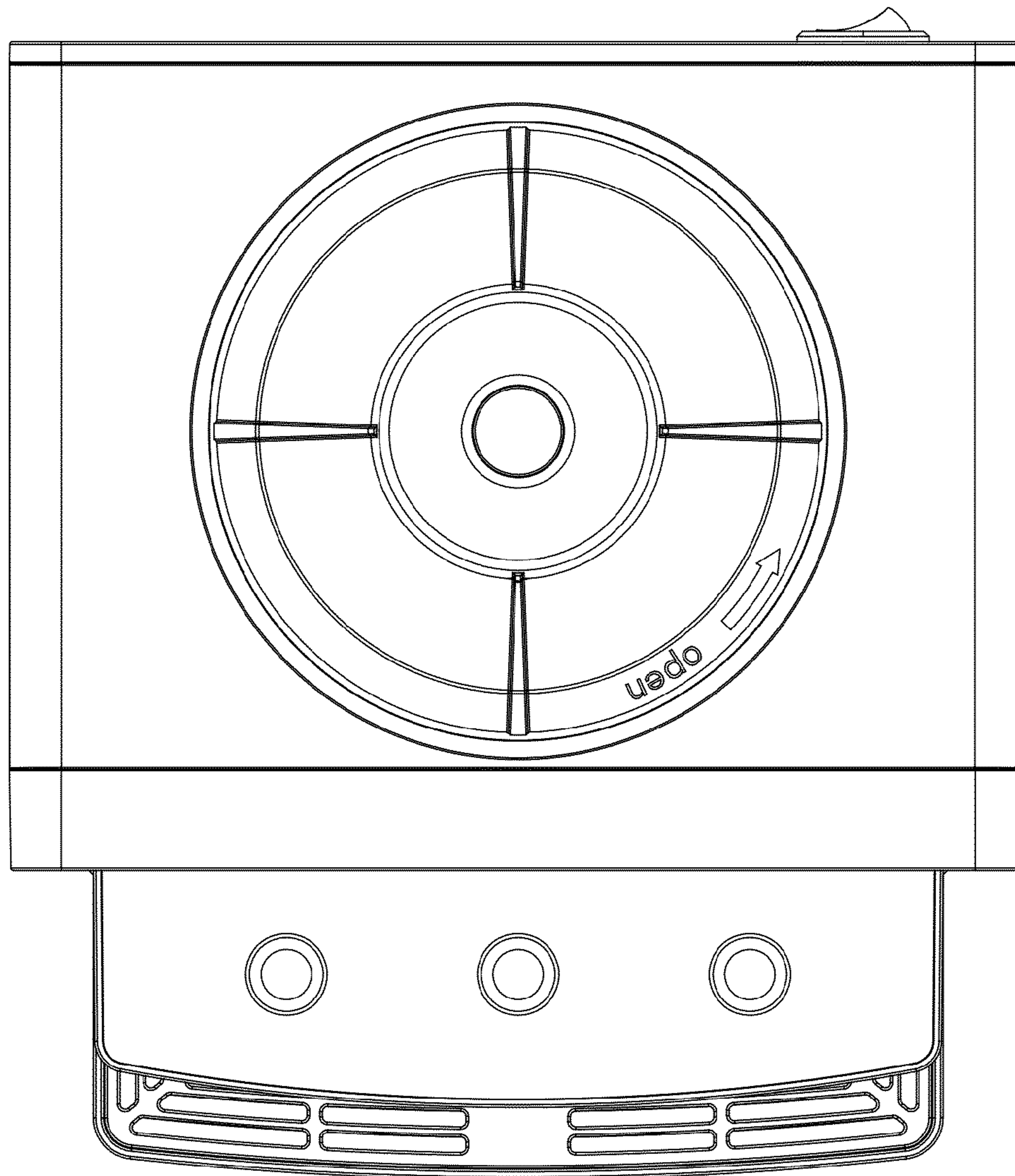

Fig. 5

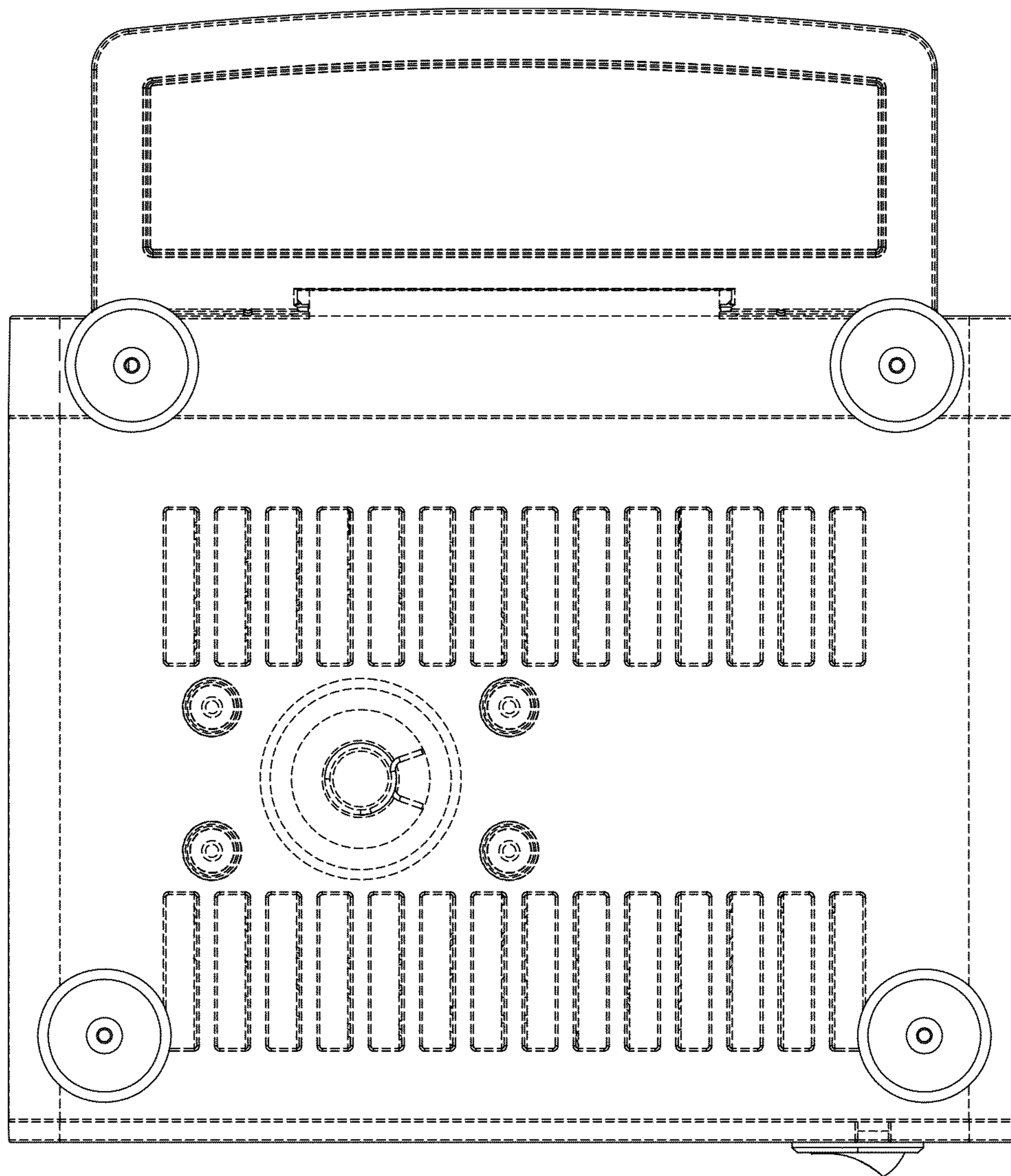

Fig. 6

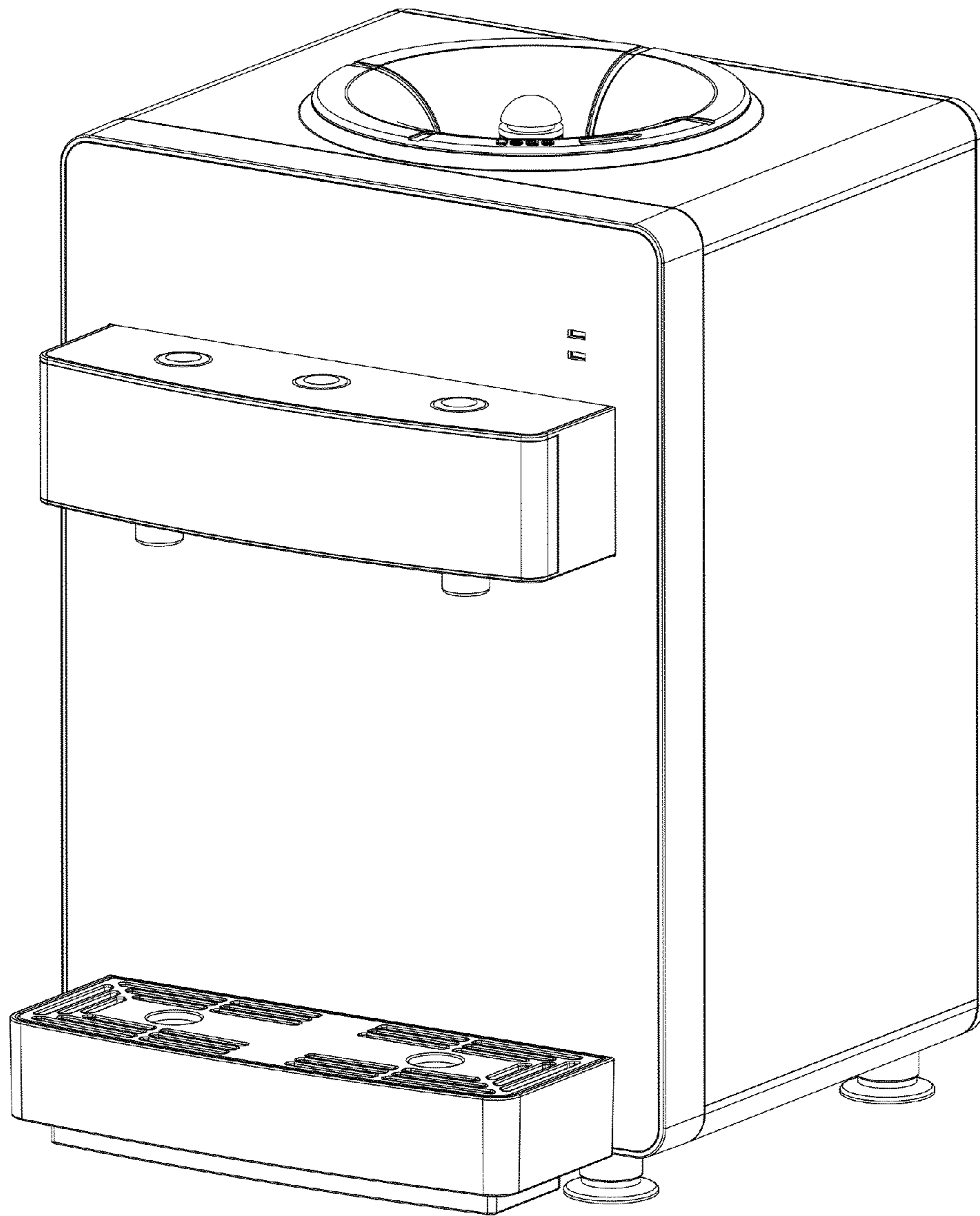

Fig. 7