



US00D701066S

(12) **United States Design Patent**
Rowland

(10) **Patent No.:** **US D701,066 S**
(45) **Date of Patent:** **** Mar. 18, 2014**

(54) **FIREPLACE BOOKCASE**

(75) Inventor: **Jay F. Rowland**, Johns Creek, GA (US)

(73) Assignee: **J.F.R. Enterprises, Inc.**, Johns Creek, GA (US)

(**) Term: **14 Years**

(21) Appl. No.: **29/397,996**

(22) Filed: **Jul. 25, 2011**

(51) **LOC (10) Cl.** **06-06**

(52) **U.S. Cl.**

USPC **D6/675.1**

(58) **Field of Classification Search**

USPC D6/437, 449, 471, 477-479, 657,
D6/672-673, 675-675.1; 312/107-108;
211/36, 42-43, 134-135, 186-188;
108/59, 161

See application file for complete search history.

(56) **References Cited**

U.S. PATENT DOCUMENTS

D257,098 S * 9/1980 Smith, Jr. D6/436
D374,573 S * 10/1996 Brunner et al. D6/479

(Continued)

Primary Examiner — Kelley Donnelly

(74) *Attorney, Agent, or Firm* — Eric W. Cernyar

(57) **CLAIM**

The ornamental design for a fireplace bookcase, as shown and described.

DESCRIPTION

FIG. 1 is a perspective view of a first embodiment of an ornamental fireplace bookcase.

FIG. 2 is a front elevational view of the embodiment of FIG. 1.

FIG. 3 is a right side elevational view of the embodiment of FIG. 1, the left side being a mirror image.

FIG. 4 is a top plan view of the embodiment of FIG. 1.

The rear of the bookcase is flat and unornamented.

FIG. 5 is a perspective view of a second embodiment of an ornamental fireplace bookcase, in which top side shelves are provided that do not extend all the way from one side of the bookcase to the other.

FIG. 6 is a front elevational view of the embodiment of FIG. 5.

FIG. 7 is a right side elevational view of the embodiment of FIG. 5, the left side being a mirror image.

FIG. 8 is a top plan view of the embodiment of FIG. 5.

The rear of the bookcase is flat and unornamented.

FIG. 9 is a perspective view of a third embodiment of an ornamental fireplace bookcase, in which all of the shelves extend all the way from one side of the bookcase to the other.

FIG. 10 is a front elevational view of the embodiment of FIG. 9.

FIG. 11 is a right side elevational view of the embodiment of FIG. 9, the left side being a mirror image.

FIG. 12 is a top plan view of the embodiment of FIG. 9.

The rear of the bookcase is flat and unornamented.

FIG. 13 is a perspective view of a fourth embodiment of an ornamental fireplace bookcase, in which the bottom side shelves of the previous embodiments are omitted.

FIG. 14 is a front elevational view of the embodiment of FIG. 13.

FIG. 15 is a right side elevational view of the embodiment of FIG. 13, the left side being a mirror image.

FIG. 16 is a top plan view of the embodiment of FIG. 13.

The rear of the bookcase is flat and unornamented.

FIG. 17 is a perspective view of a fifth embodiment of an ornamental fireplace bookcase, in which the bottom shelves extend to the right and left behind the vertical side posts of the bookcase.

FIG. 18 is a front elevational view of the embodiment of FIG. 17.

FIG. 19 is a right side elevational view of the embodiment of FIG. 17, the left side being a mirror image; and,

FIG. 20 is a top plan view of the embodiment of FIG. 17.

The rear of the bookcase is flat and unornamented.

The broken line portions of the drawings illustrate fireplace post and cornice molding and trim that forms no part of the claimed design or a specific embodiment thereof.

1 Claim, 15 Drawing Sheets

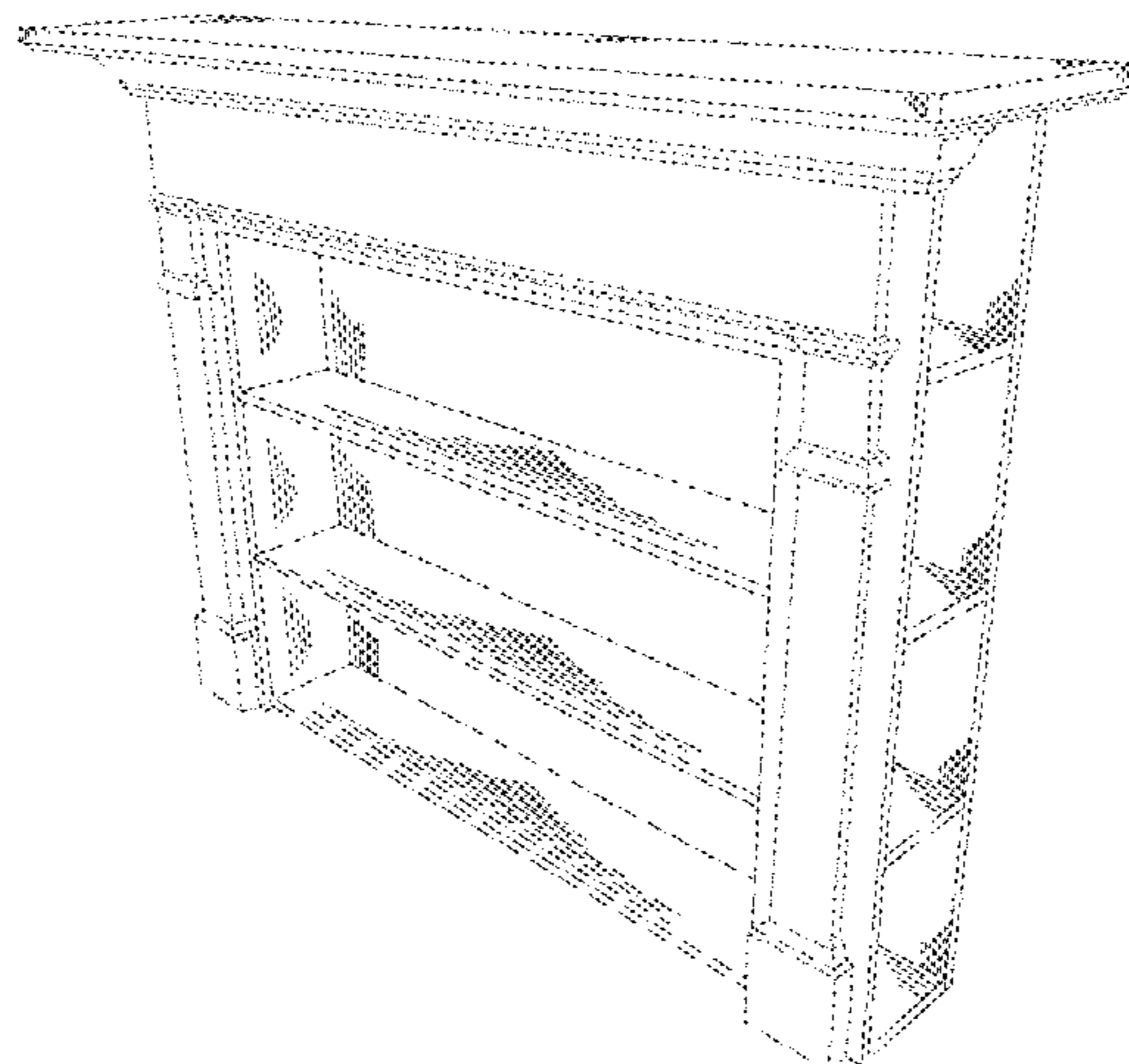

(56)

References Cited

U.S. PATENT DOCUMENTS

D430,757 S * 9/2000 Draheim et al. D6/477
D435,988 S * 1/2001 Draheim et al. D6/509
D444,654 S * 7/2001 Draheim et al. D6/509
6,283,563 B1 * 9/2001 Lambright et al. 312/205
D487,853 S * 3/2004 Woods D6/436

D560,410 S * 1/2008 Draheim D6/509
D580,690 S * 11/2008 Draheim D6/509
D580,691 S * 11/2008 Draheim D6/509
D590,643 S * 4/2009 Domack et al. D6/509
D601,368 S * 10/2009 Calco D6/478
D643,109 S * 8/2011 Hadi D23/404
D658,405 S * 5/2012 O'Brien D6/479
D658,406 S * 5/2012 O'Brien D6/479

* cited by examiner



FIG. 1

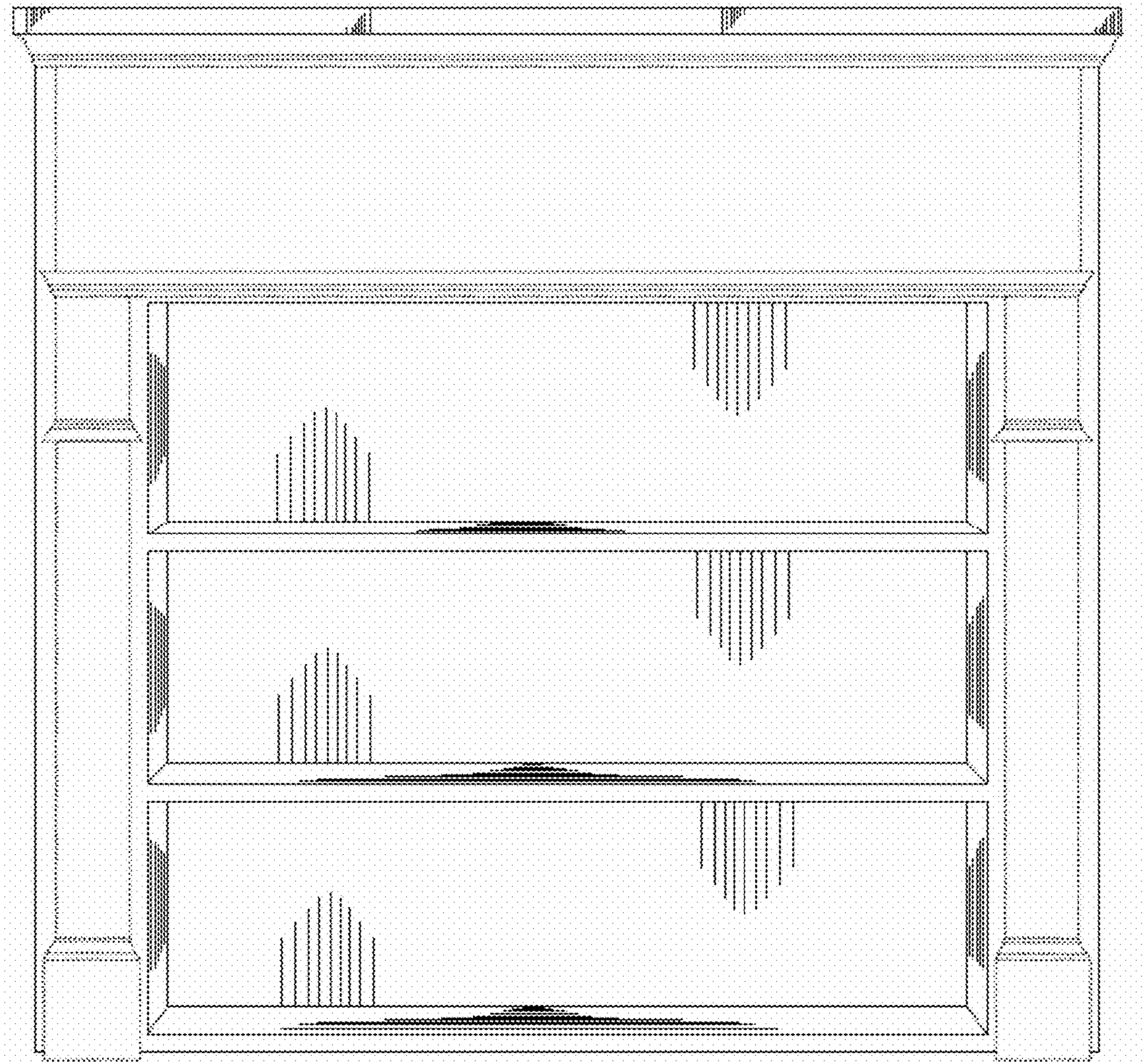

FIG. 2

FIG. 3

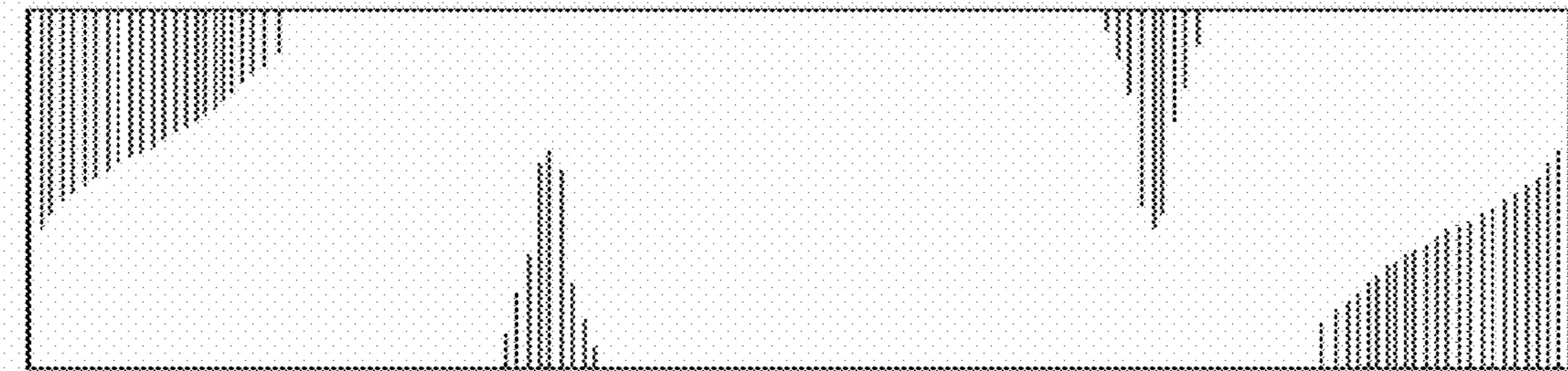
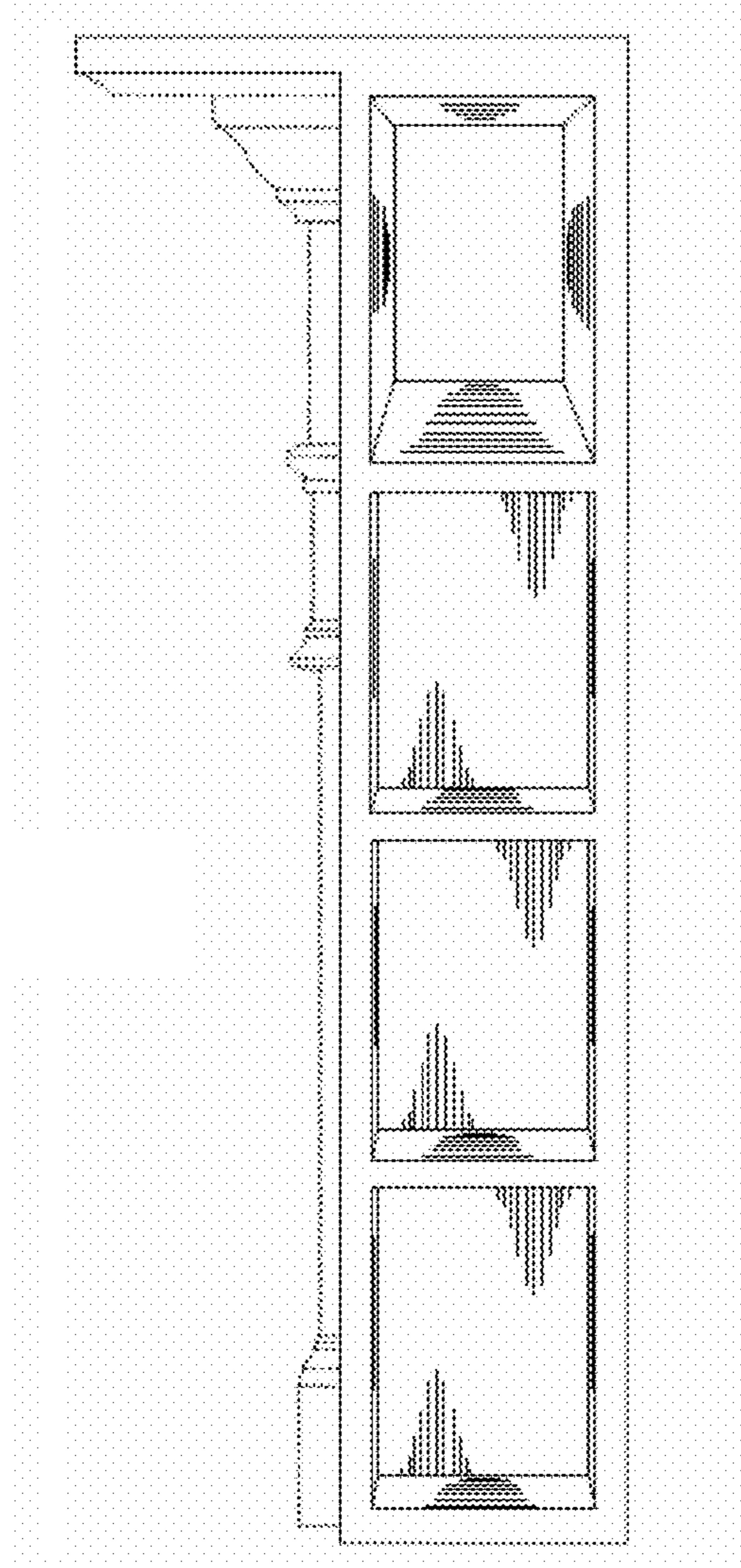

FIG. 4



FIG. 5

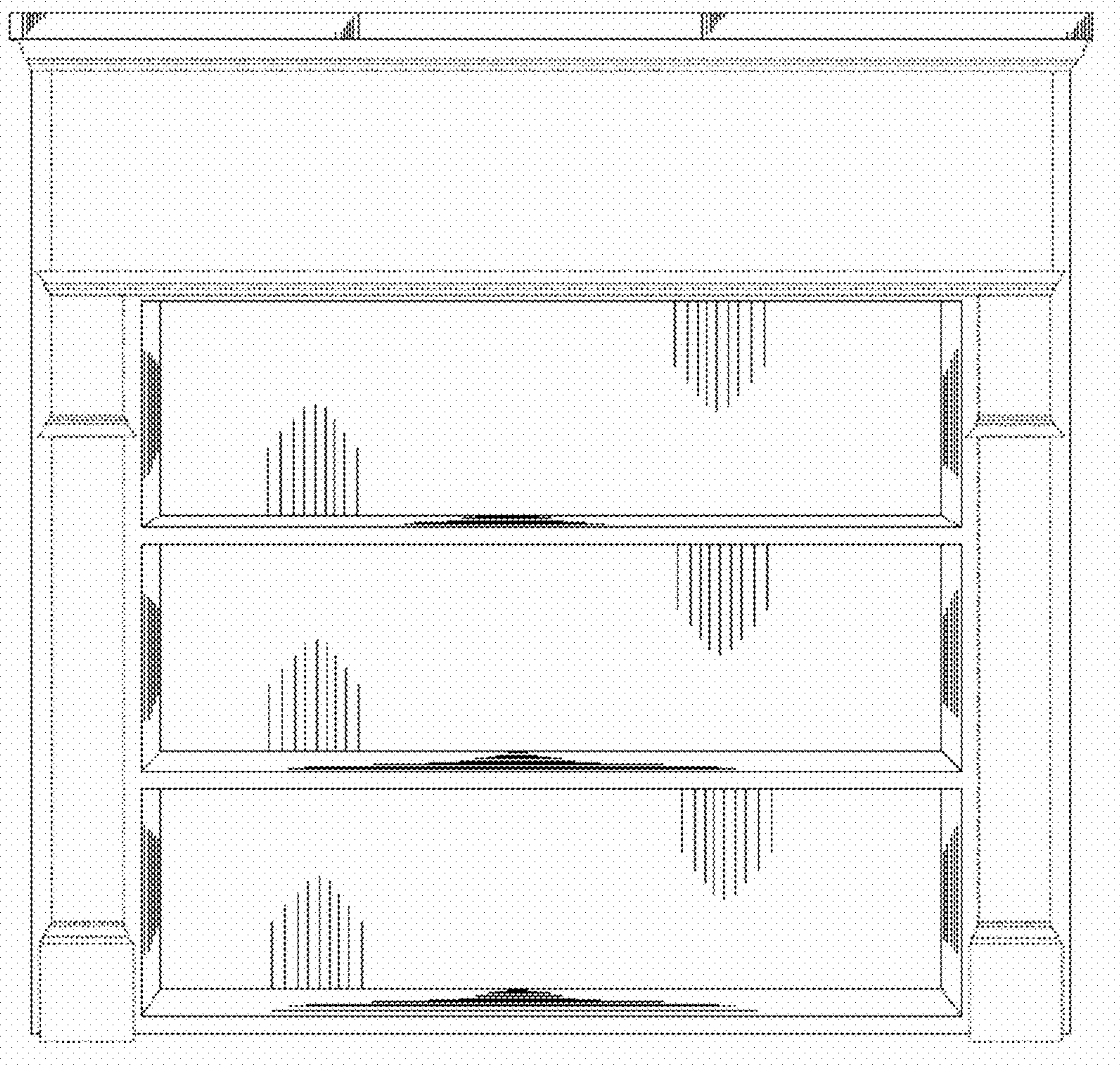

FIG. 6

FIG. 7

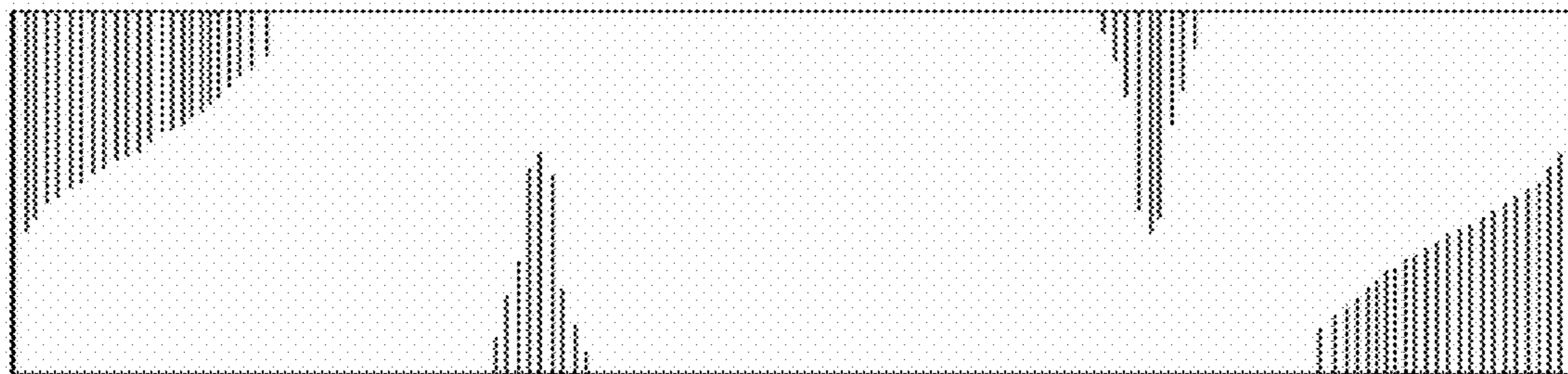
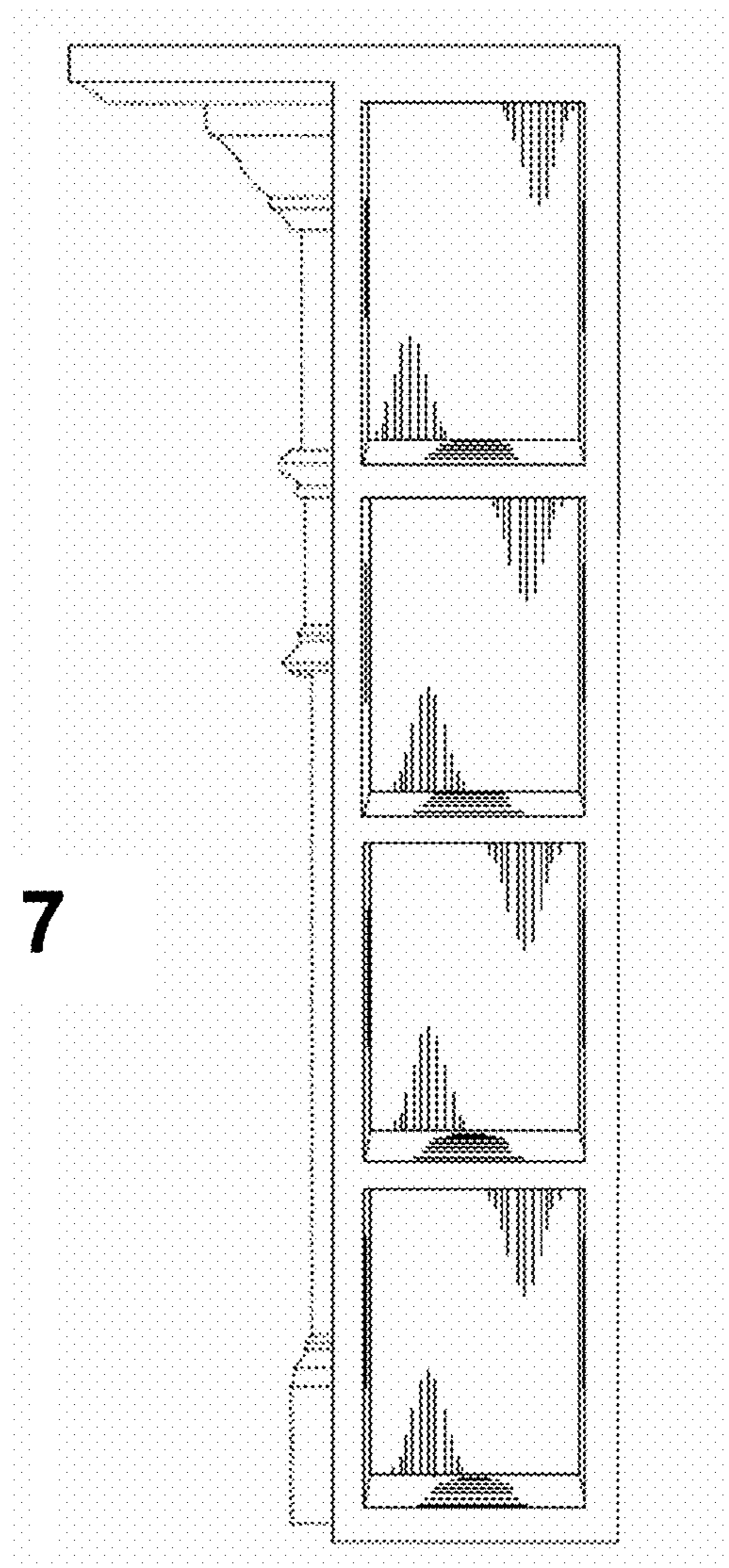

FIG. 8

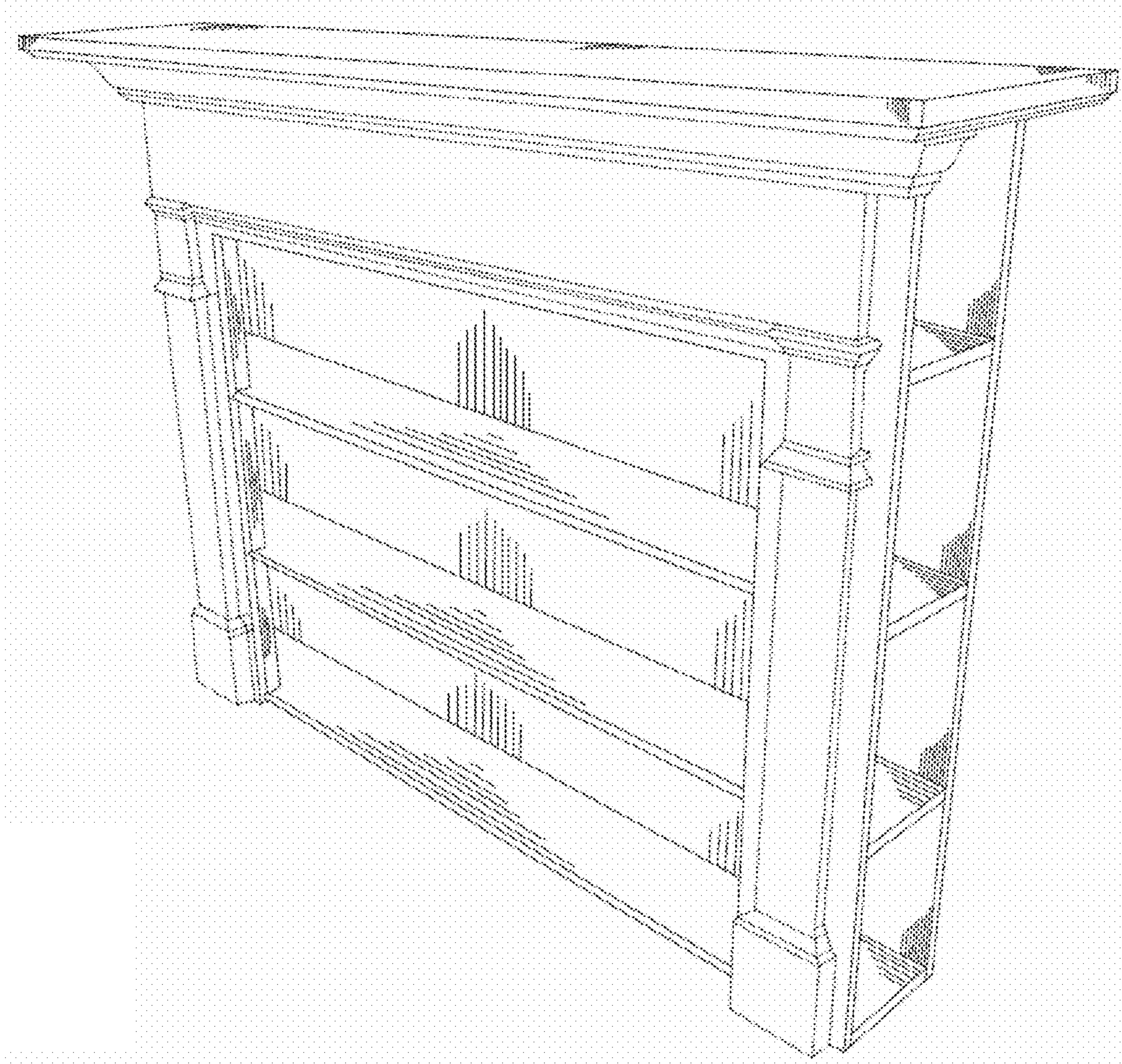

FIG. 9

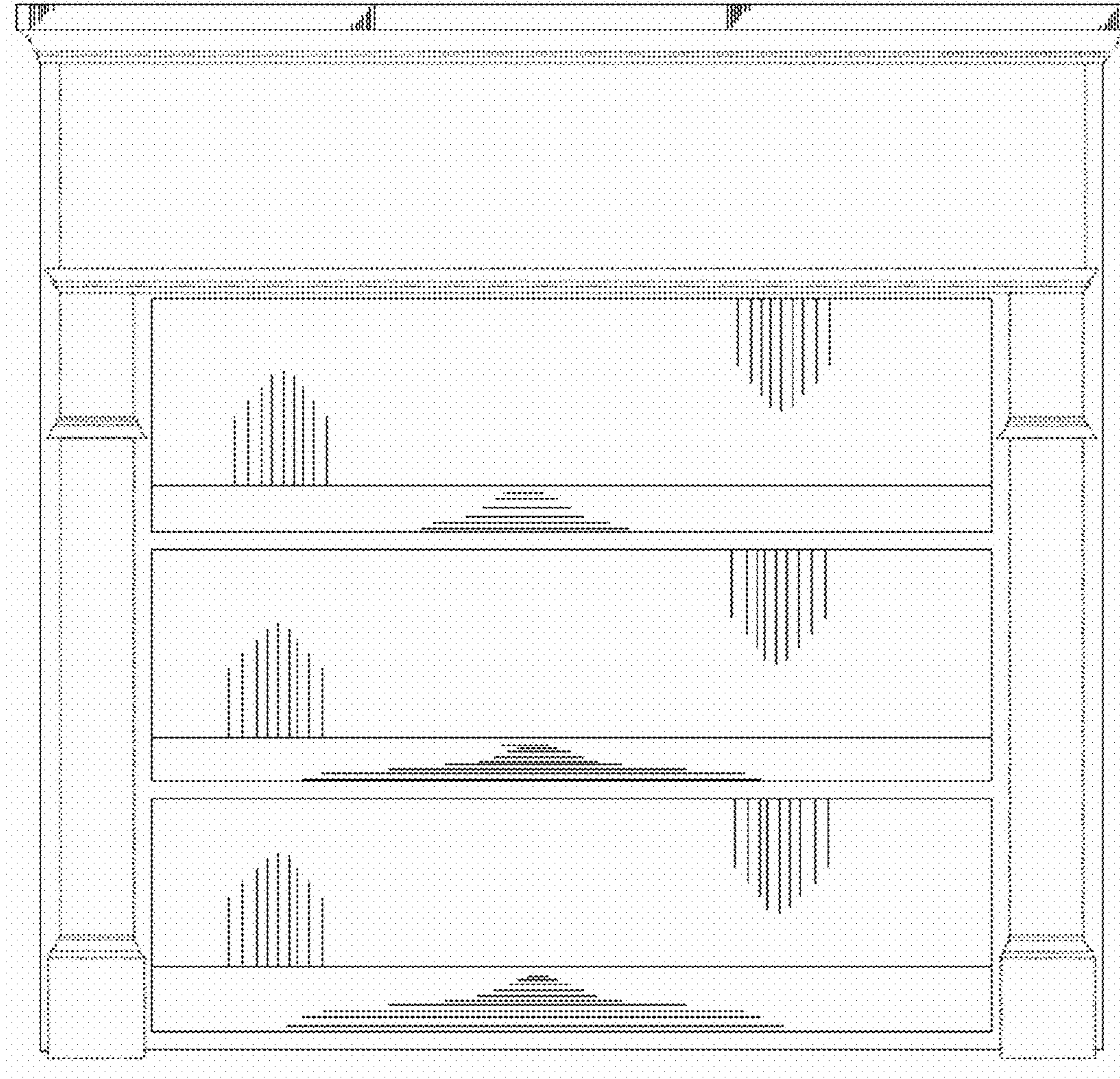

FIG. 10

FIG. 11

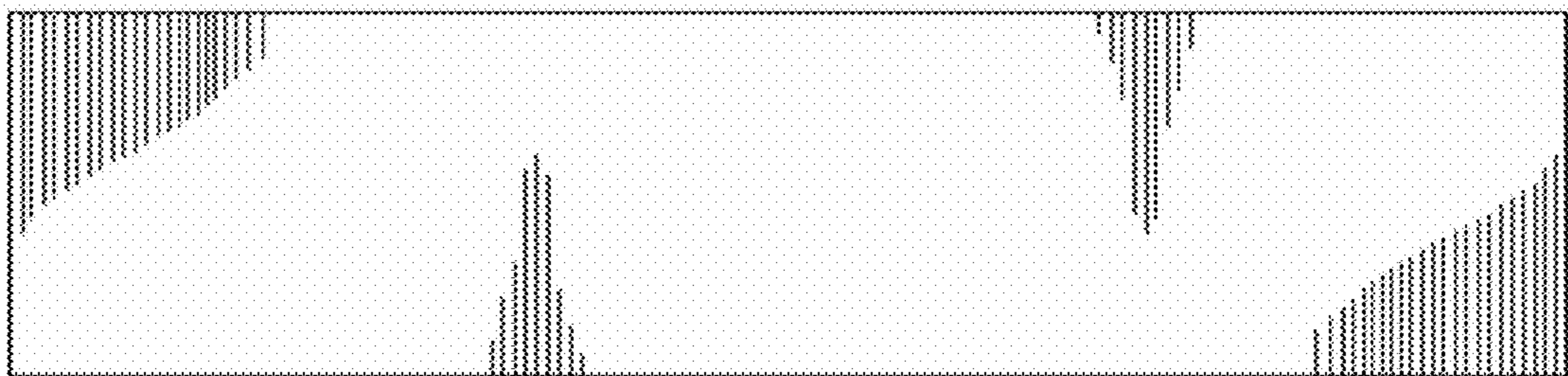
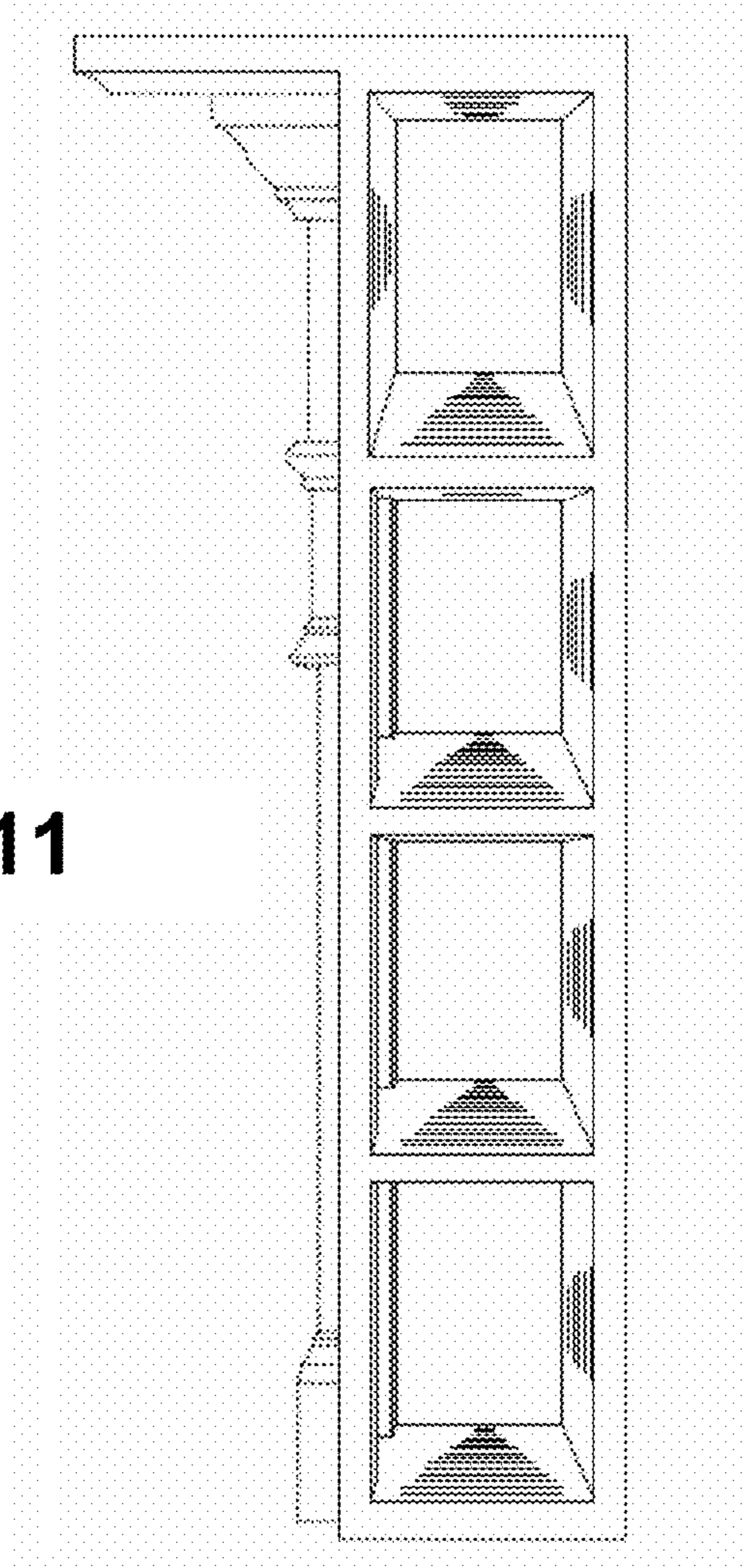

FIG. 12



FIG. 13

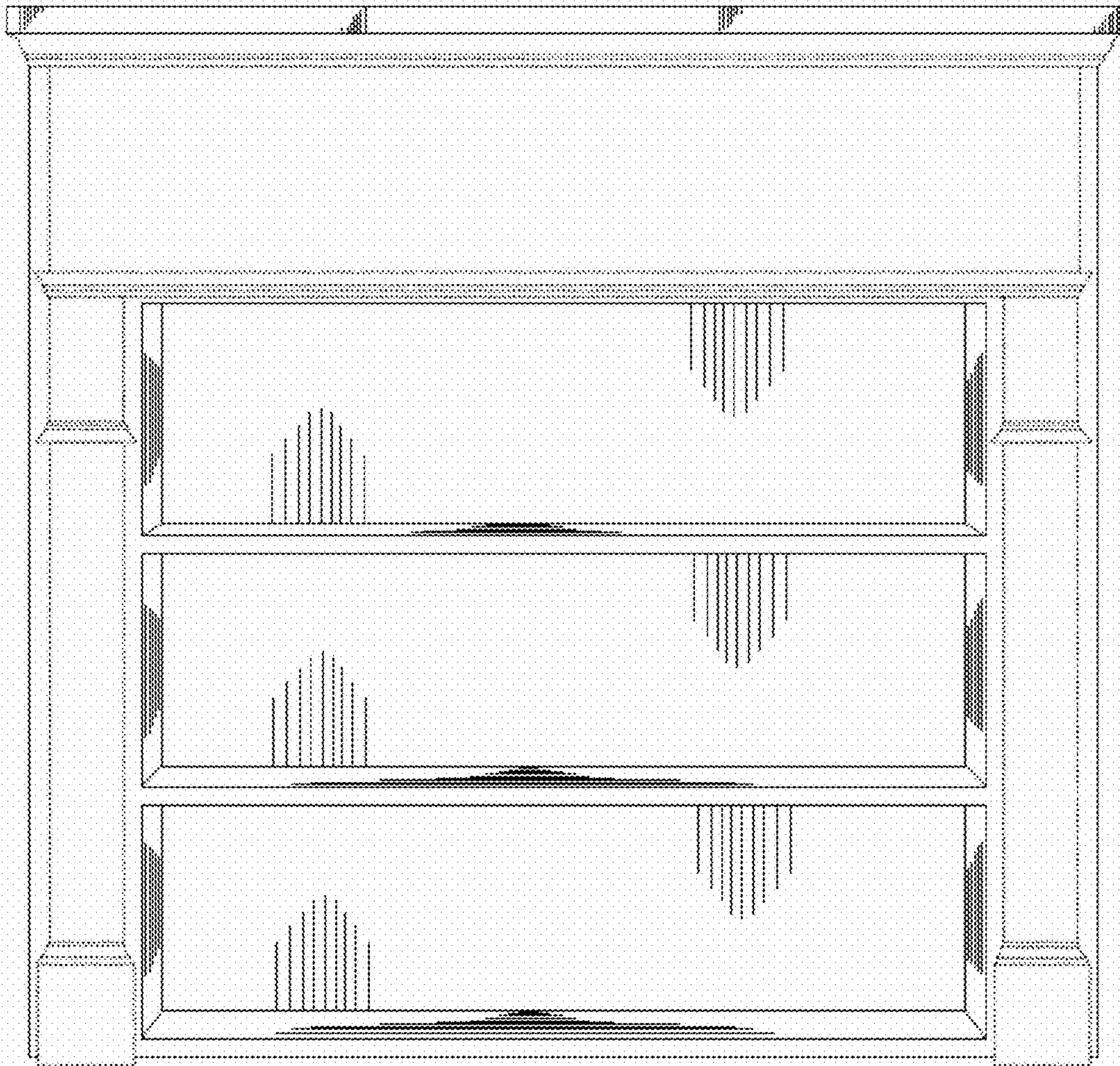

FIG. 14

FIG. 15

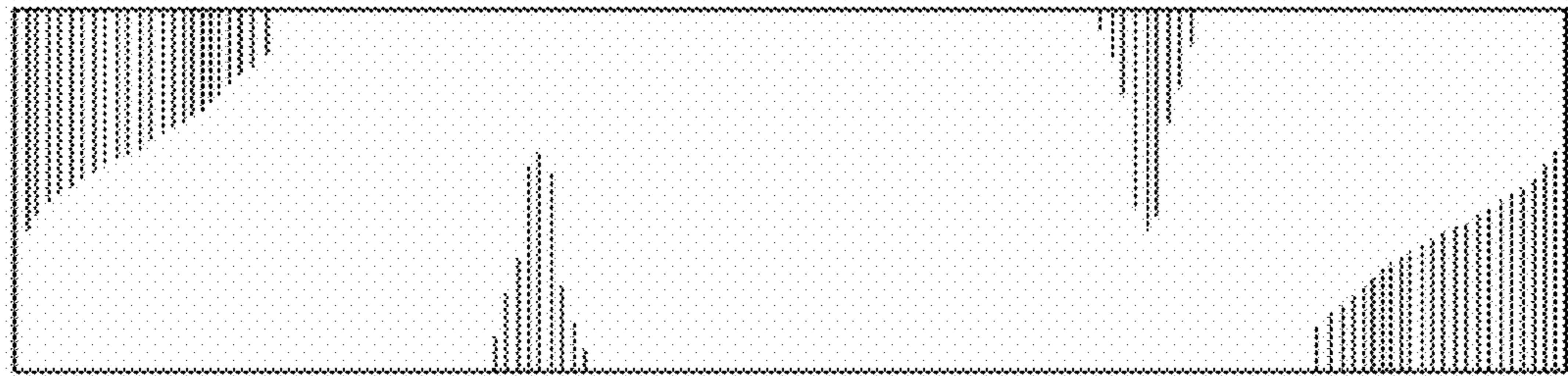
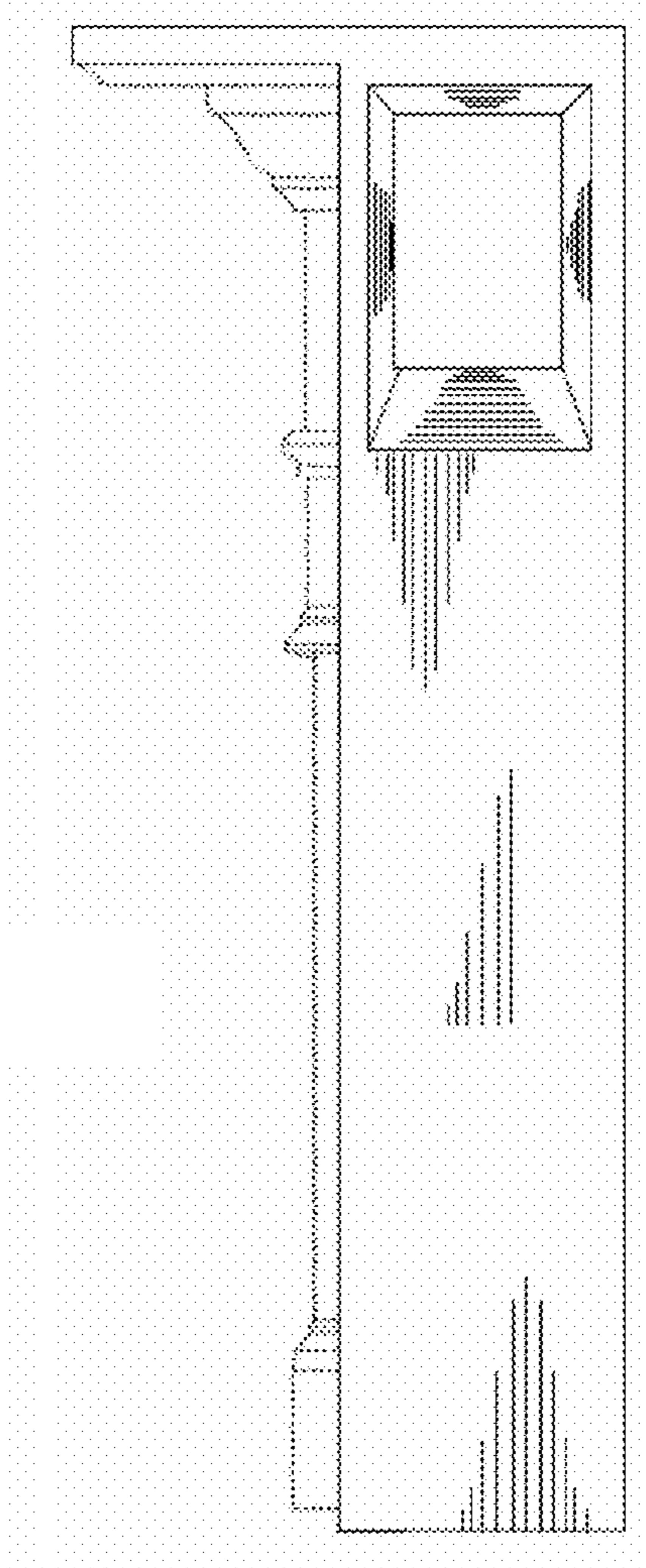

FIG. 16



FIG. 17

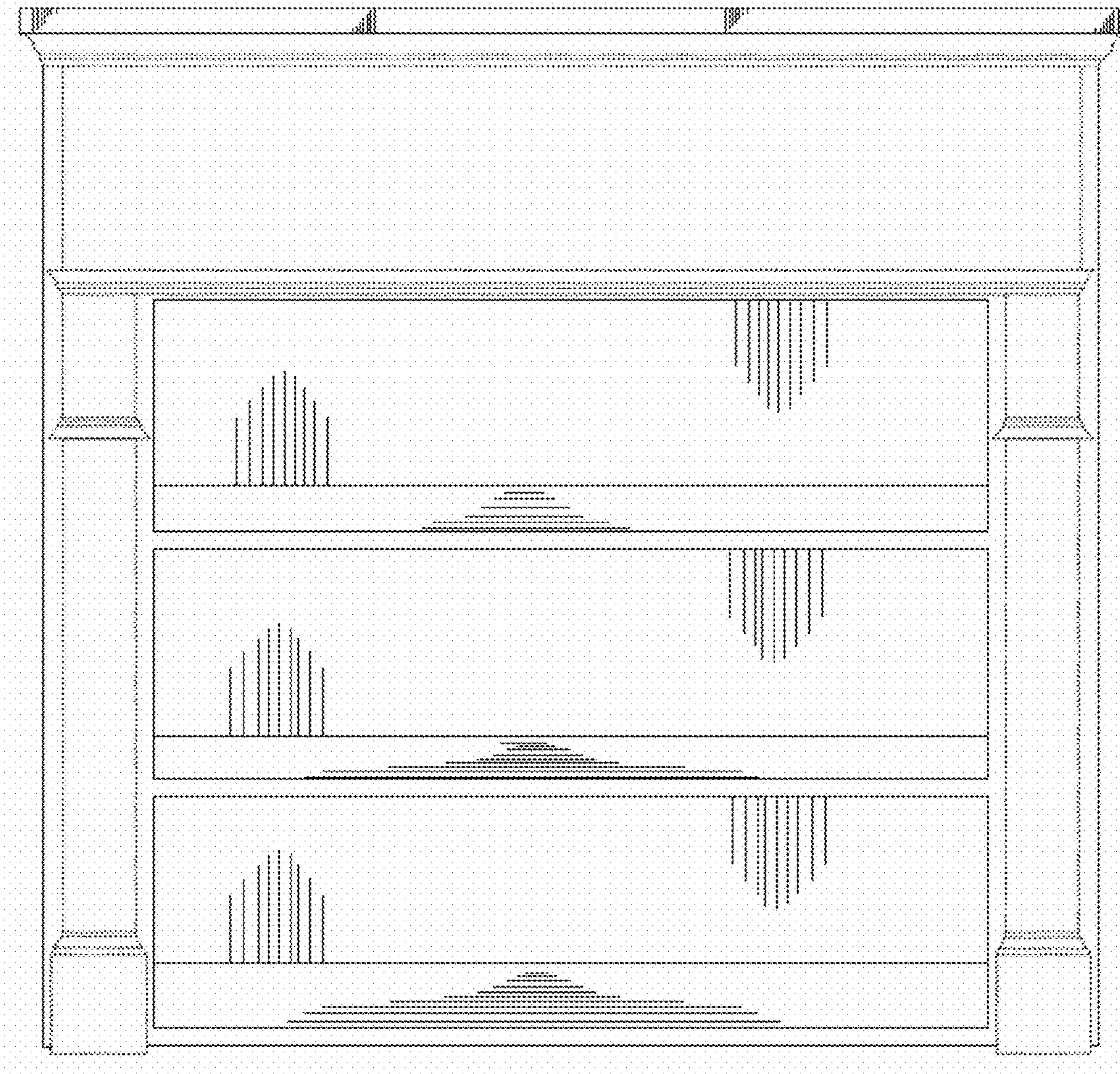

FIG. 18

FIG. 19

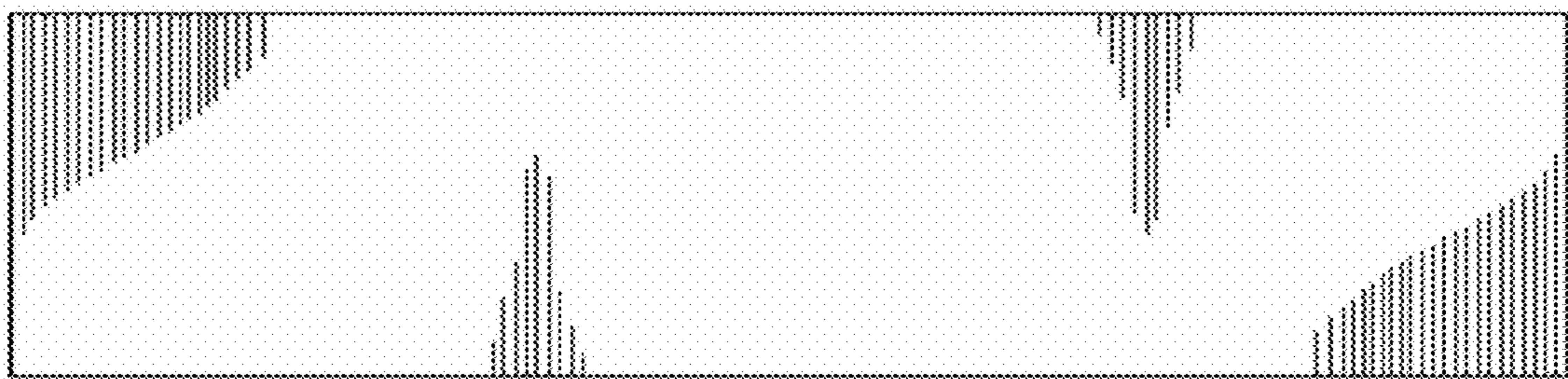
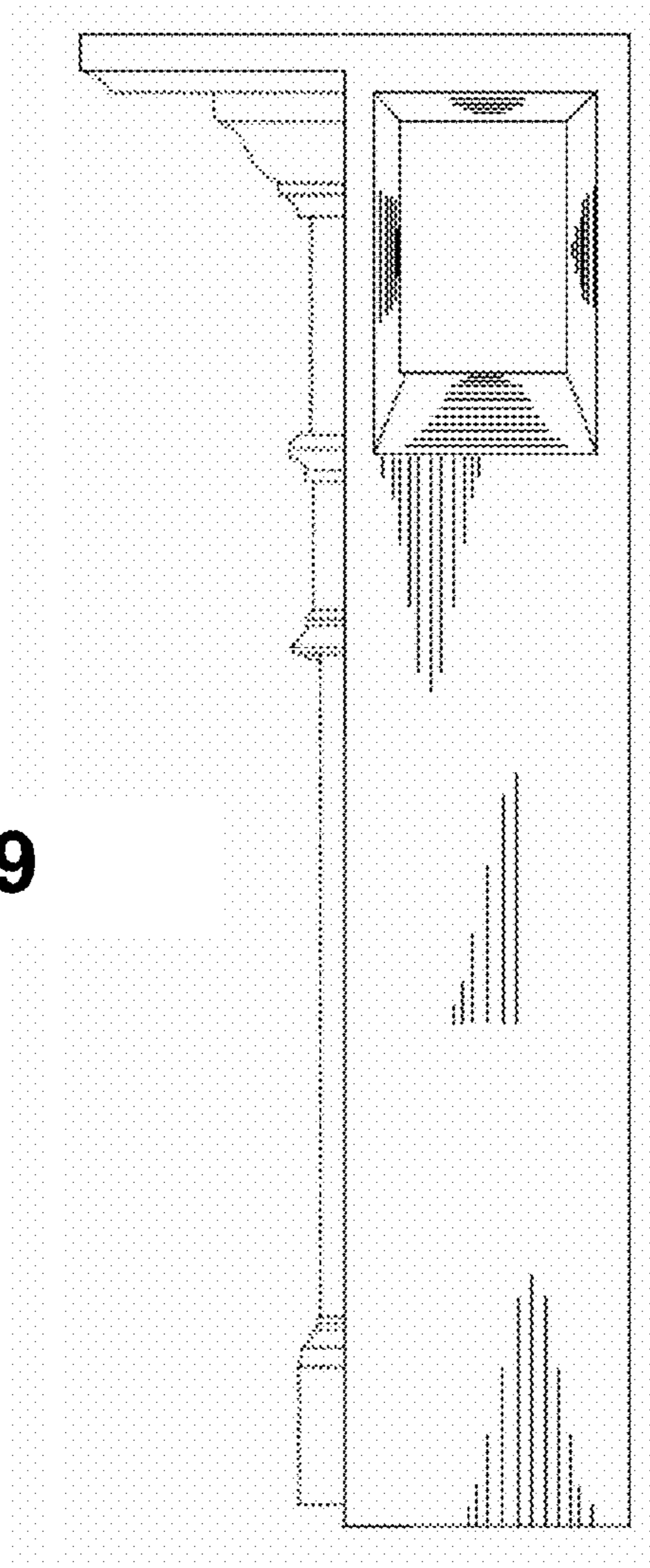

FIG. 20