



US00D701042S

(12) **United States Design Patent**
Austin

(10) **Patent No.:** **US D701,042 S**
(45) **Date of Patent:** **** Mar. 18, 2014**

(54) **DECORATIVE WALLET**

(71) Applicant: **Michael Austin**, Redding, CA (US)

(72) Inventor: **Michael Austin**, Redding, CA (US)

(**) Term: **14 Years**

(21) Appl. No.: **29/435,804**

(22) Filed: **Oct. 29, 2012**

(51) **LOC (10) Cl.** **03-01**

(52) **U.S. Cl.**
USPC **D3/247**

(58) **Field of Classification Search**
USPC **D3/247, 249-253, 318; 150/130, 132,**
150/136-137, 147
See application file for complete search history.

(56) **References Cited**

U.S. PATENT DOCUMENTS

D572,473 S *	7/2008	Tuttle	D3/248
D572,474 S *	7/2008	Tuttle	D3/248
D584,050 S	1/2009	Austin		
D612,599 S *	3/2010	Lee	D3/248

* cited by examiner

Primary Examiner — Holly Baynham

(74) *Attorney, Agent, or Firm* — Mohr Intellectual Property Law Solutions, PC

(57) **CLAIM**

The ornamental design for a decorative wallet, as shown and described.

DESCRIPTION

FIG. 1 is a top perspective view of a decorative wallet according to a second embodiment.

FIG. 2 is a bottom perspective view of a decorative wallet according to the embodiment shown in FIG. 1.

FIG. 3 is a rear perspective view of a decorative wallet according to the embodiment shown in FIG. 1 illustrating the decorative wallet in an open configuration.

FIG. 4 is a side perspective view of a decorative wallet according to the embodiment shown in FIG. 1 illustrating the decorative wallet in an open configuration.

FIG. 5 is a top view of a decorative wallet according to the embodiment shown in FIG. 1.

FIG. 6 is a bottom view of a decorative wallet according to the embodiment shown in FIG. 1.

FIG. 7 is a side elevation view of a decorative wallet according to the embodiment shown in FIG. 1.

FIG. 8 is a side elevation view of a decorative wallet according to the embodiment shown in FIG. 1.

FIG. 9 is a rear elevation view of a decorative wallet according to the embodiment shown in FIG. 1; and,

FIG. 10 is a front elevation view of a decorative wallet according to the embodiment shown in FIG. 1.

The claimed ornamental design is shown in solid lines. Any dashed lines in the drawings are for illustrative purposes only and form no part of the claimed design.

1 Claim, 5 Drawing Sheets

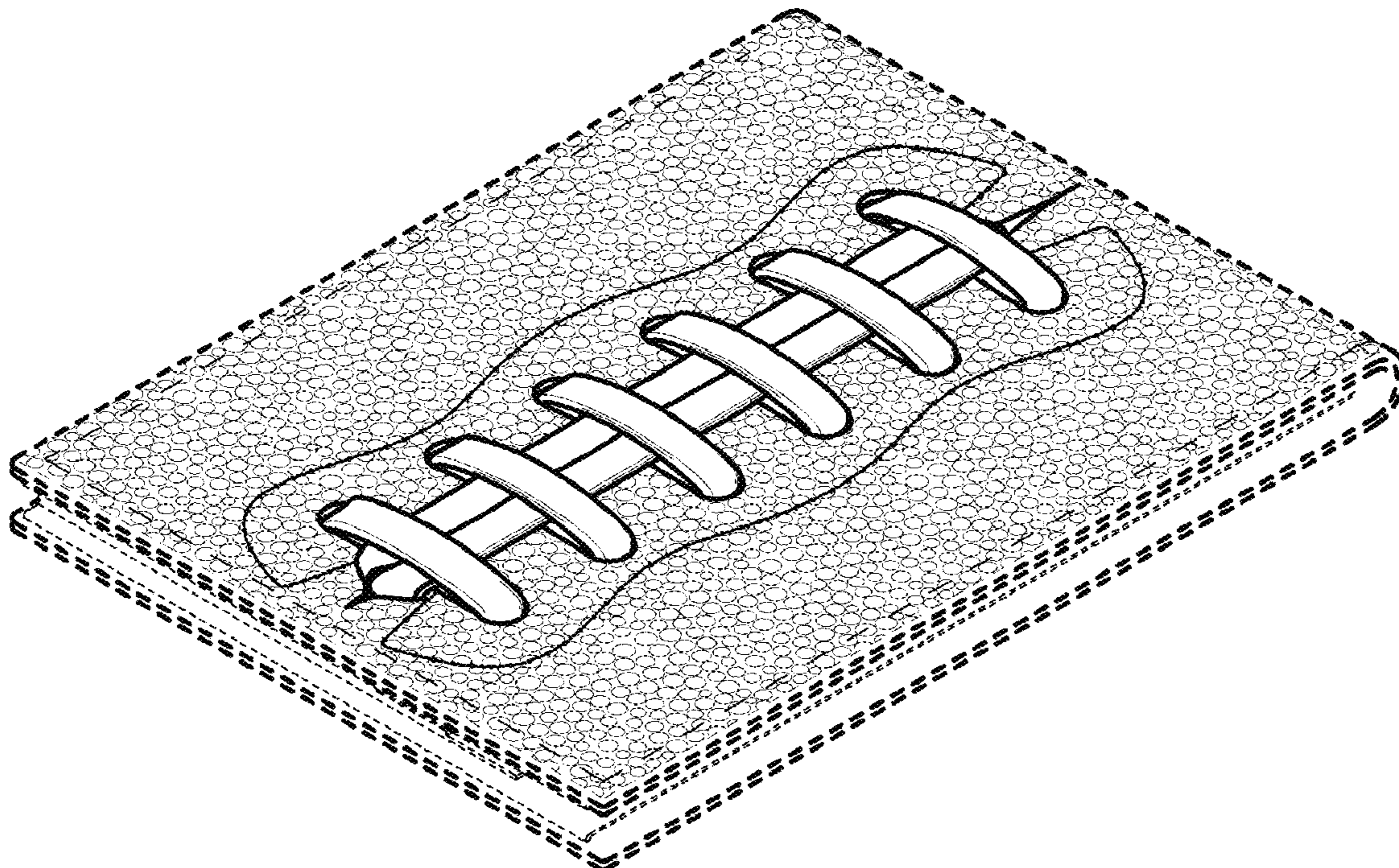

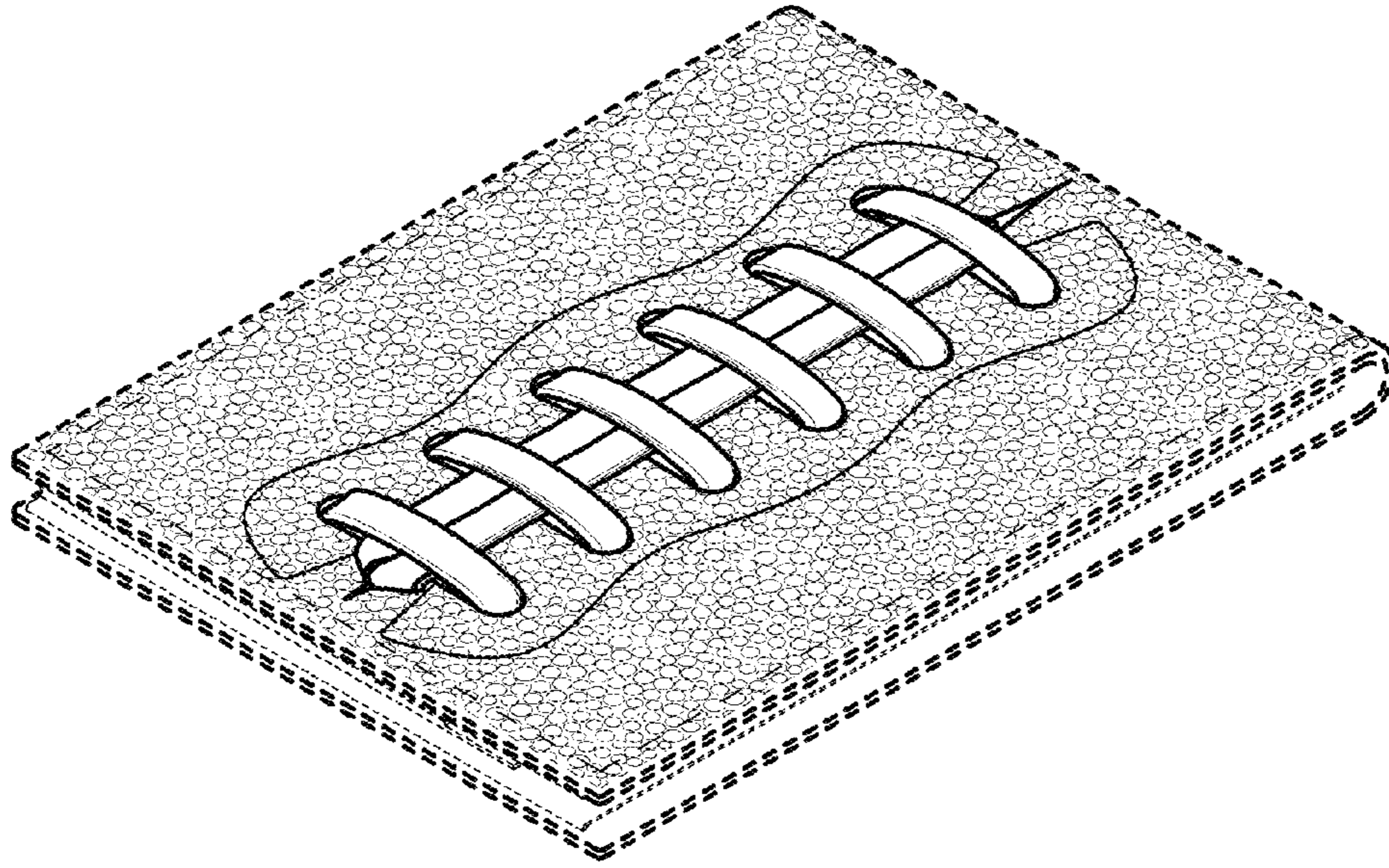

FIG.1

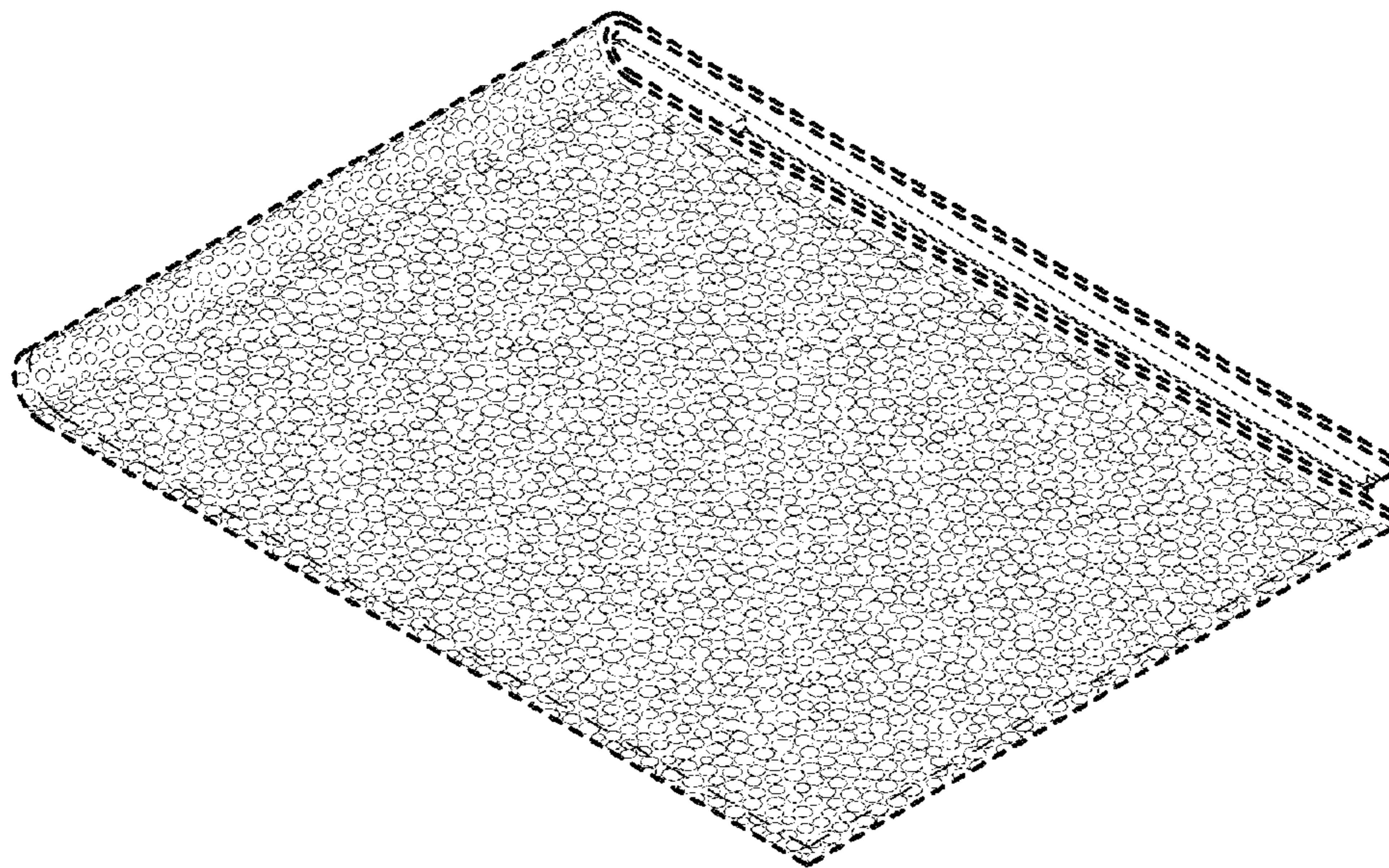

FIG.2

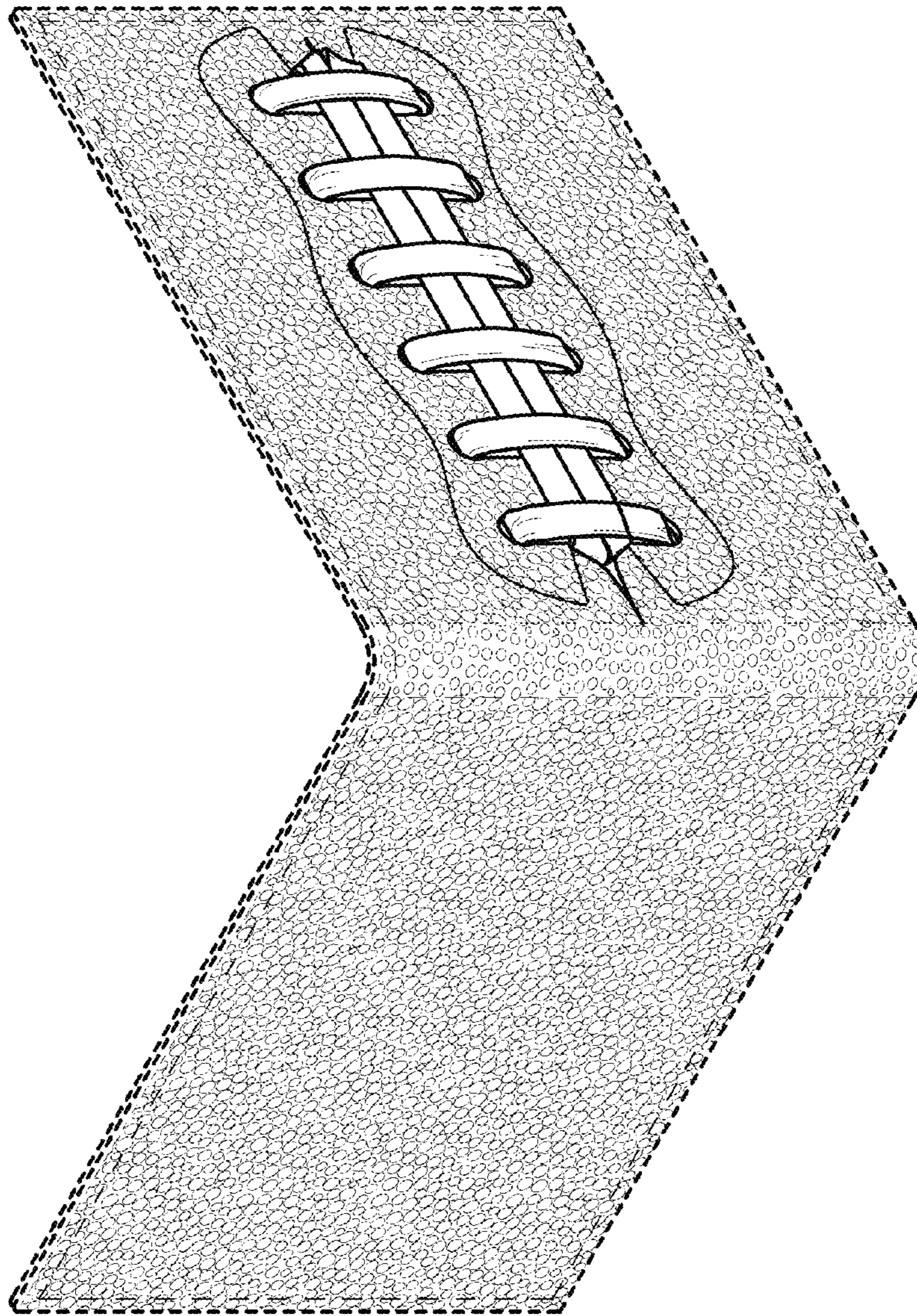

FIG.3

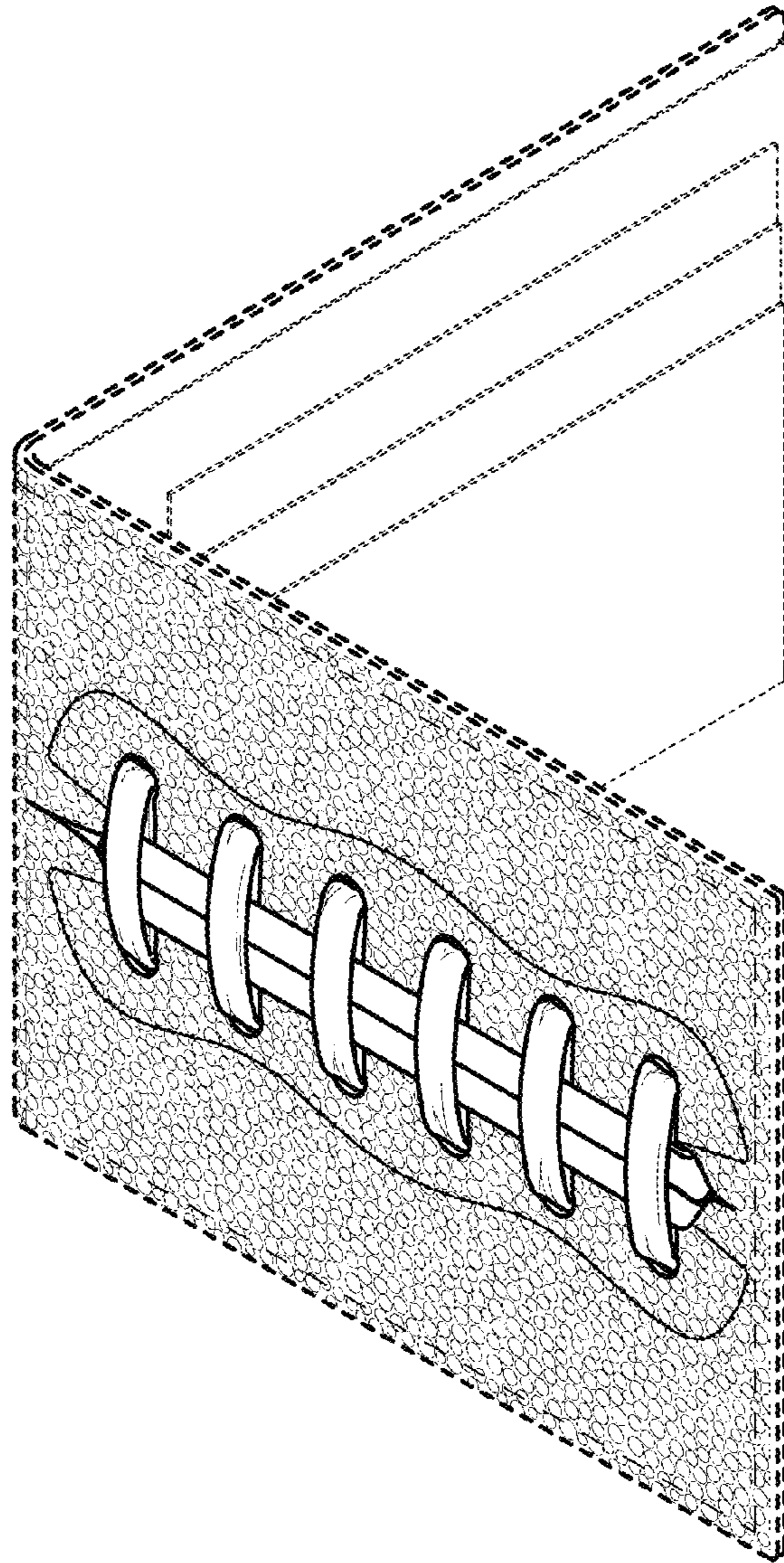

FIG.4

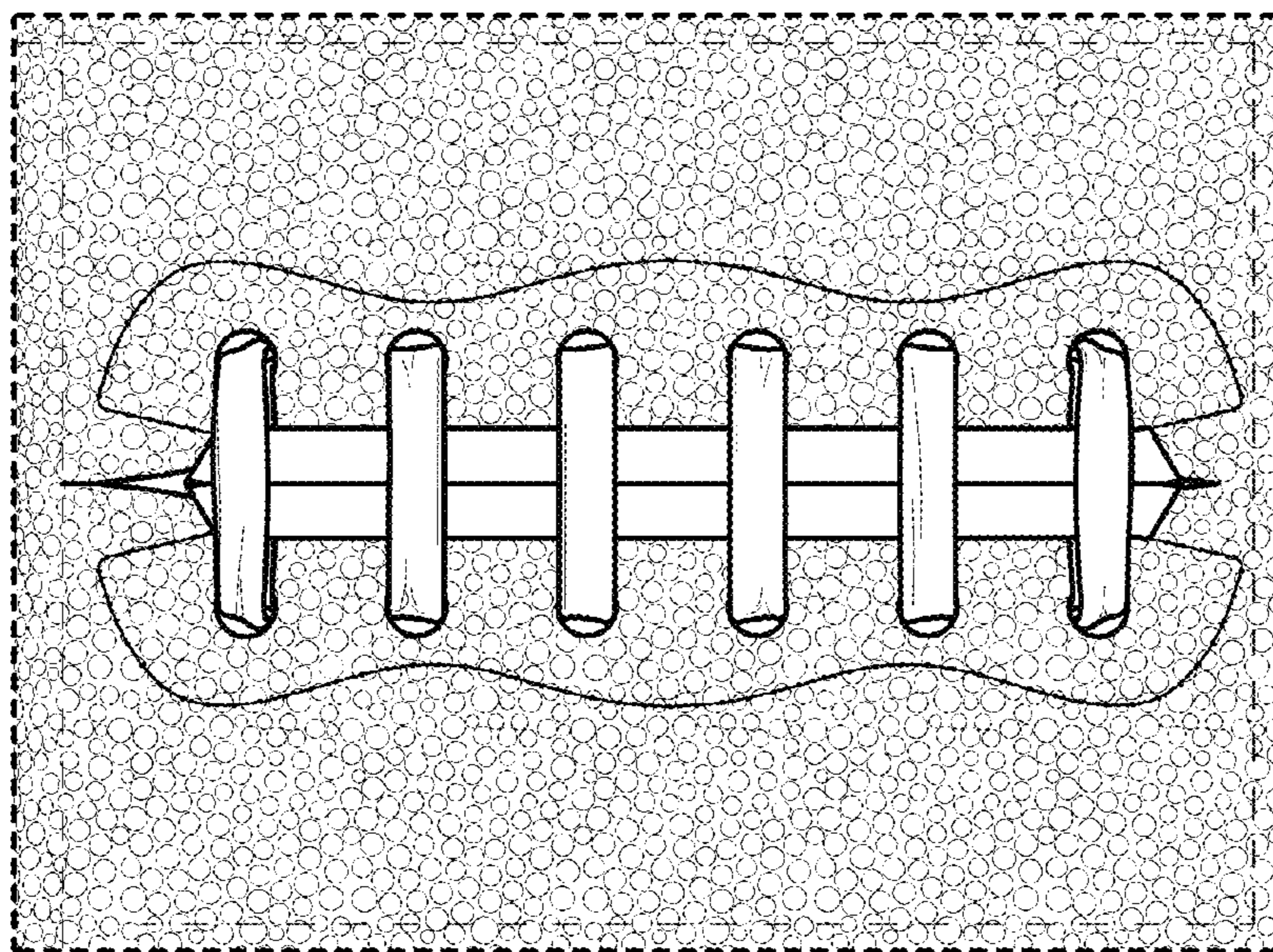

FIG. 5

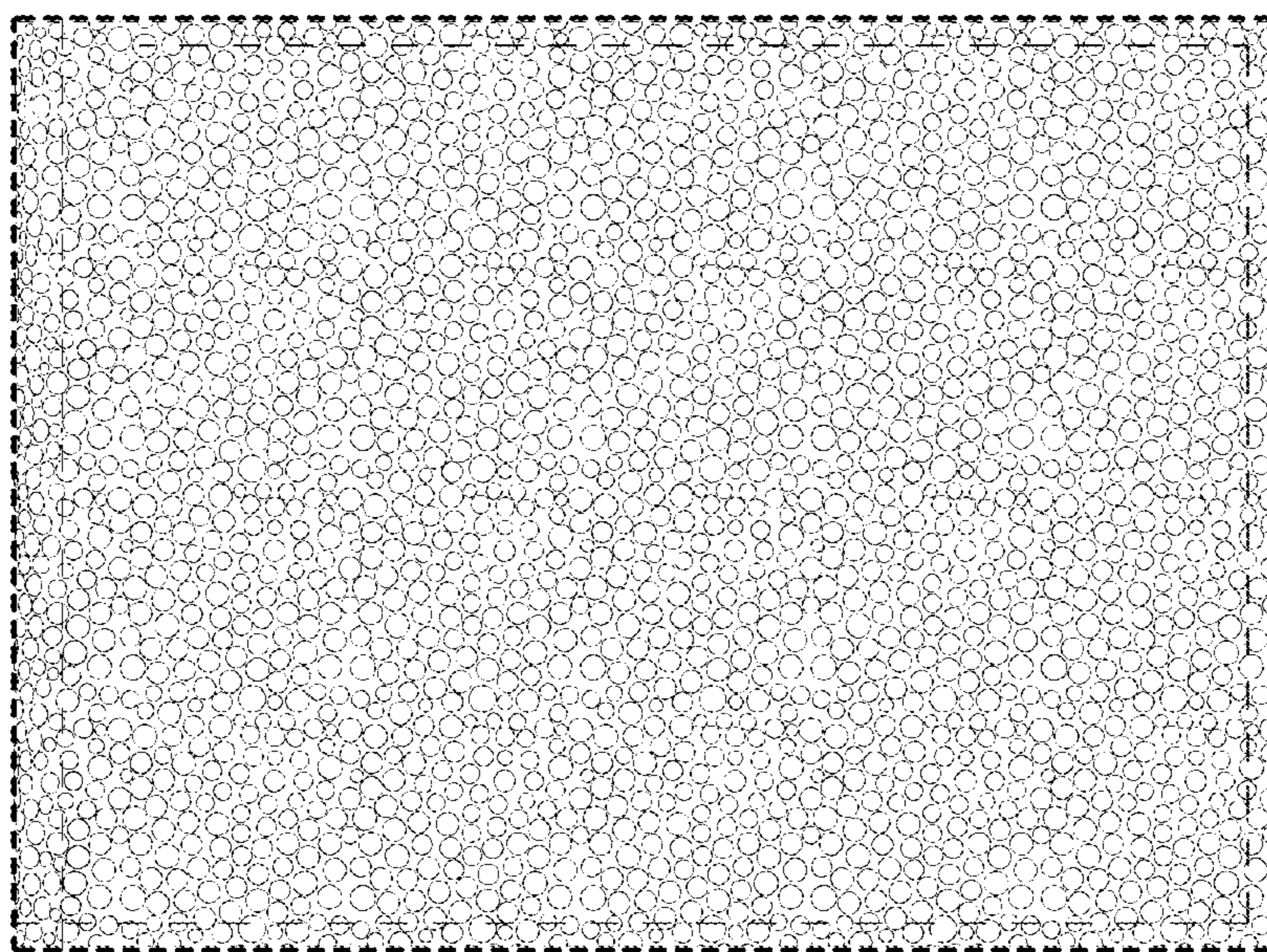

FIG. 6

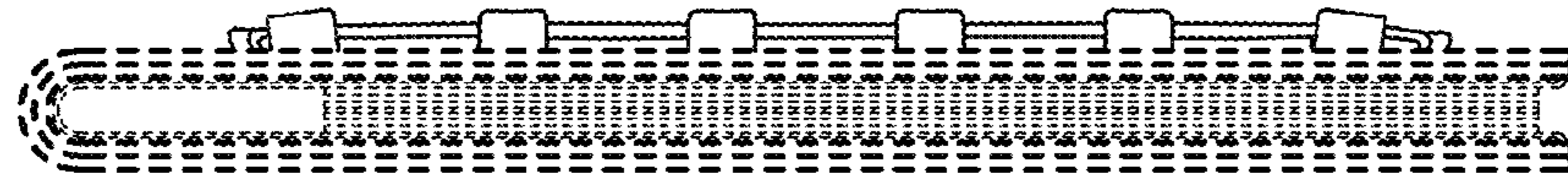

FIG. 7

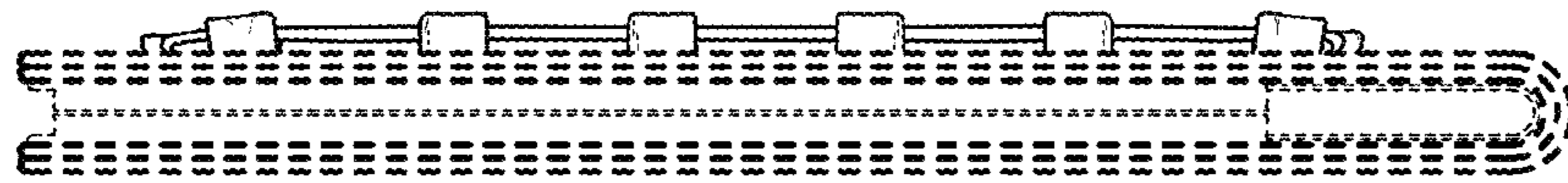

FIG. 8

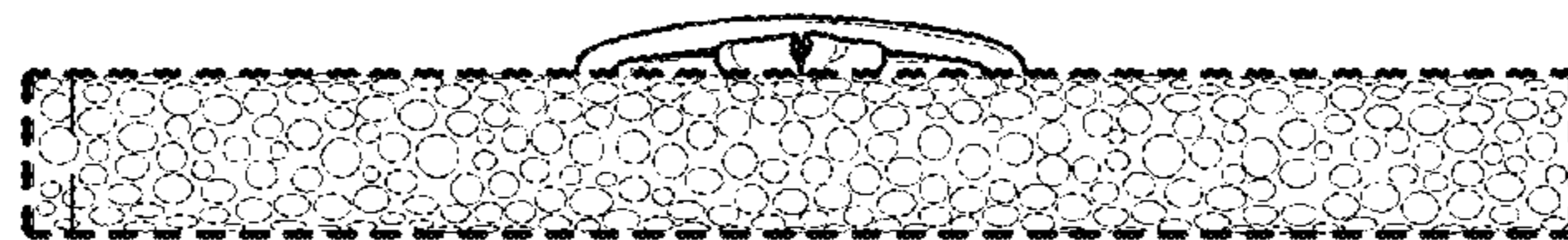

FIG. 9

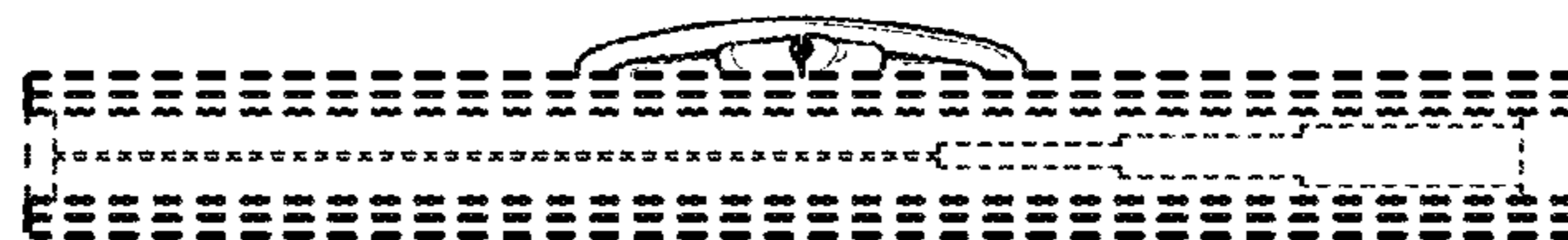

FIG. 10