



US00D700852S

(12) **United States Design Patent**
Winkler

(10) **Patent No.:** **US D700,852 S**

(45) **Date of Patent:** **** Mar. 11, 2014**

(54) **BUOY**

6,074,259 A * 6/2000 Lastrajoli et al. 441/1
D602,389 S * 10/2009 Gilman et al. D10/107

(71) Applicant: **Wilson Offshore & Marine (USA), Inc.**,
Houston, TX (US)

* cited by examiner

(72) Inventor: **Daniel Urs Winkler**, Richmond, TX
(US)

Primary Examiner — George D Kirschbaum

(74) *Attorney, Agent, or Firm* — Patterson & Sheridan, LLP

(73) Assignee: **Wilson Offshore & Marine (USA),
Inc.**, Houston, TX (US)

(57) **CLAIM**

The ornamental design for a buoy, as shown and described.

(**) Term: **14 Years**

DESCRIPTION

(21) Appl. No.: **29/440,107**

(22) Filed: **Dec. 19, 2012**

Related U.S. Application Data

(62) Division of application No. 29/399,508, filed on Aug.
15, 2011, now Pat. No. Des. 682,132.

(51) **LOC (10) Cl.** **10-05**

(52) **U.S. Cl.**
USPC **D10/107**

(58) **Field of Classification Search**
USPC D10/107; 441/1, 5
See application file for complete search history.

(56) **References Cited**

U.S. PATENT DOCUMENTS

4,279,047 A * 7/1981 van Heijst 441/5
D310,180 S * 8/1990 Etkin D10/107

FIG. 1 is a top plan view of a first embodiment of a buoy showing my new design;
FIG. 2 is a front elevational view thereof;
FIG. 3 is a left side elevational view thereof;
FIG. 4 is a rear elevational view thereof;
FIG. 5 is a right side elevational view thereof;
FIG. 6 is a bottom plan view thereof;
FIG. 7 is a top plan view of a second embodiment of the buoy;
FIG. 8 is a front elevational view thereof;
FIG. 9 is a left side elevational view thereof;
FIG. 10 is a rear elevational view thereof;
FIG. 11 is a right side elevational view thereof;
FIG. 12 is a bottom plan view thereof;
FIG. 13 is a top plan view of a third embodiment of the buoy;
FIG. 14 is a front elevational view thereof;
FIG. 15 is a left side elevational view thereof;
FIG. 16 is a rear elevational view thereof;
FIG. 17 is a right side elevational view thereof; and,
FIG. 18 is a bottom plan view thereof.

The broken lines shown in the drawings illustrate environmental structure and form no part of the claimed design.

1 Claim, 18 Drawing Sheets

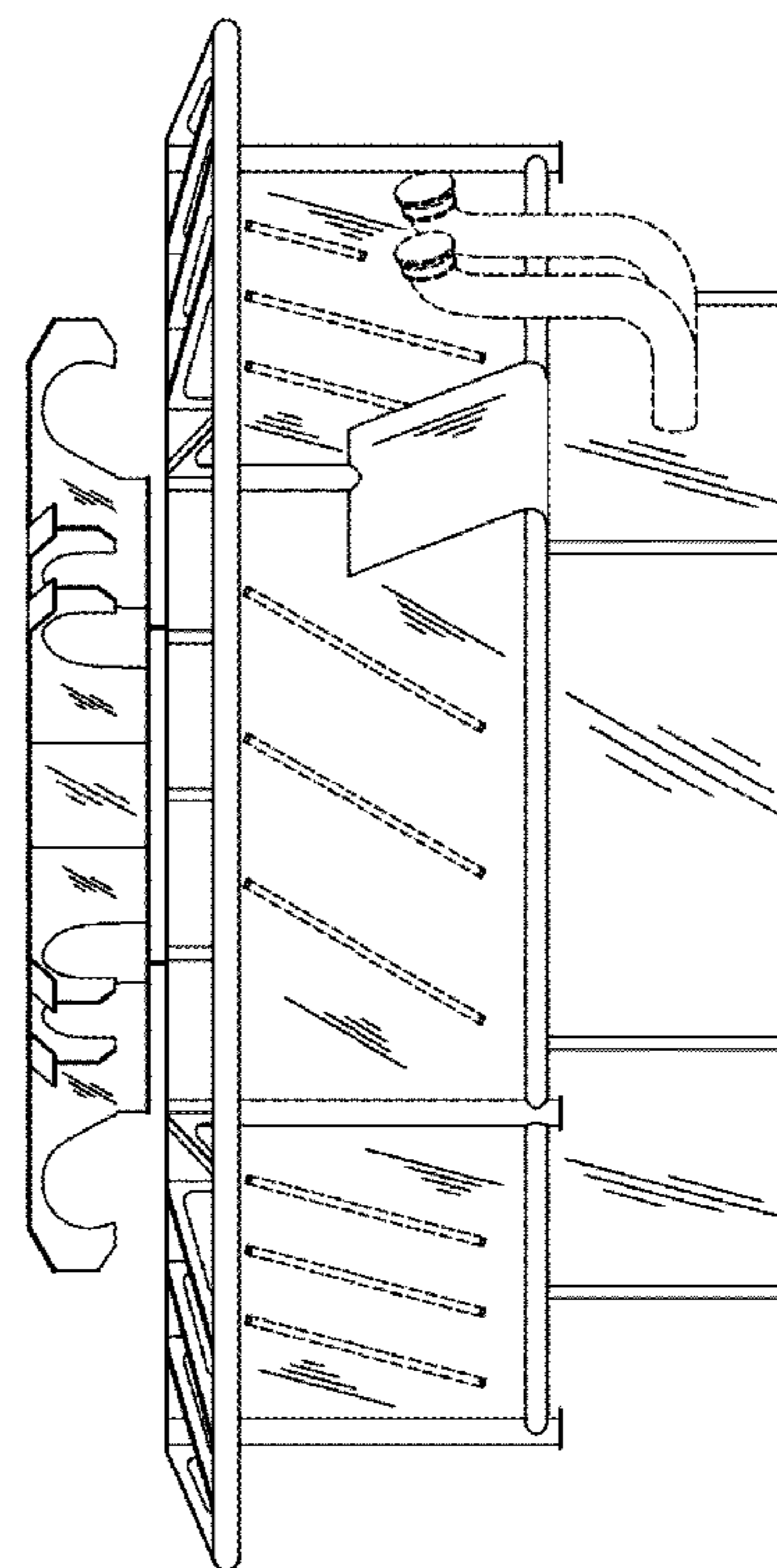
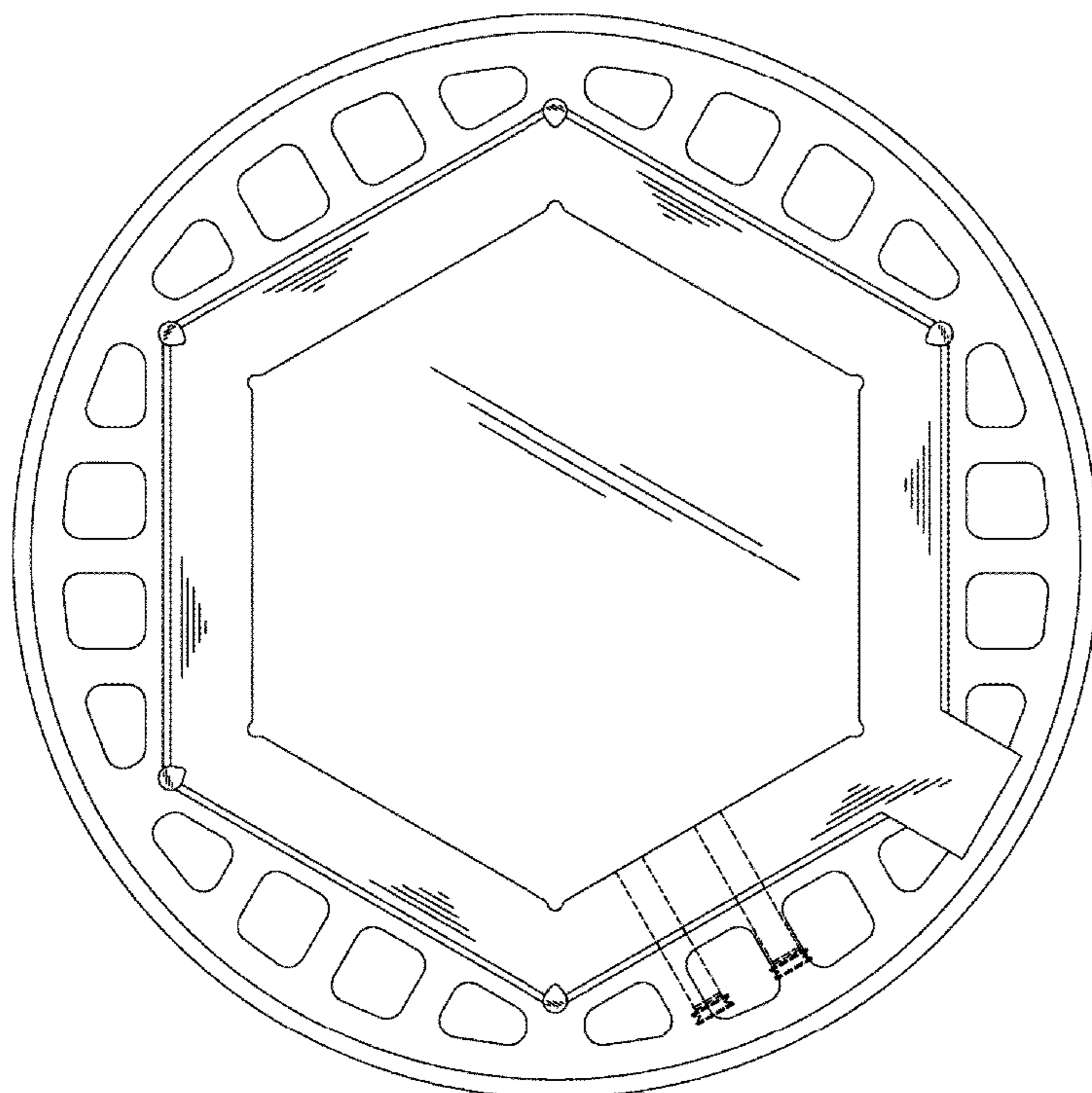

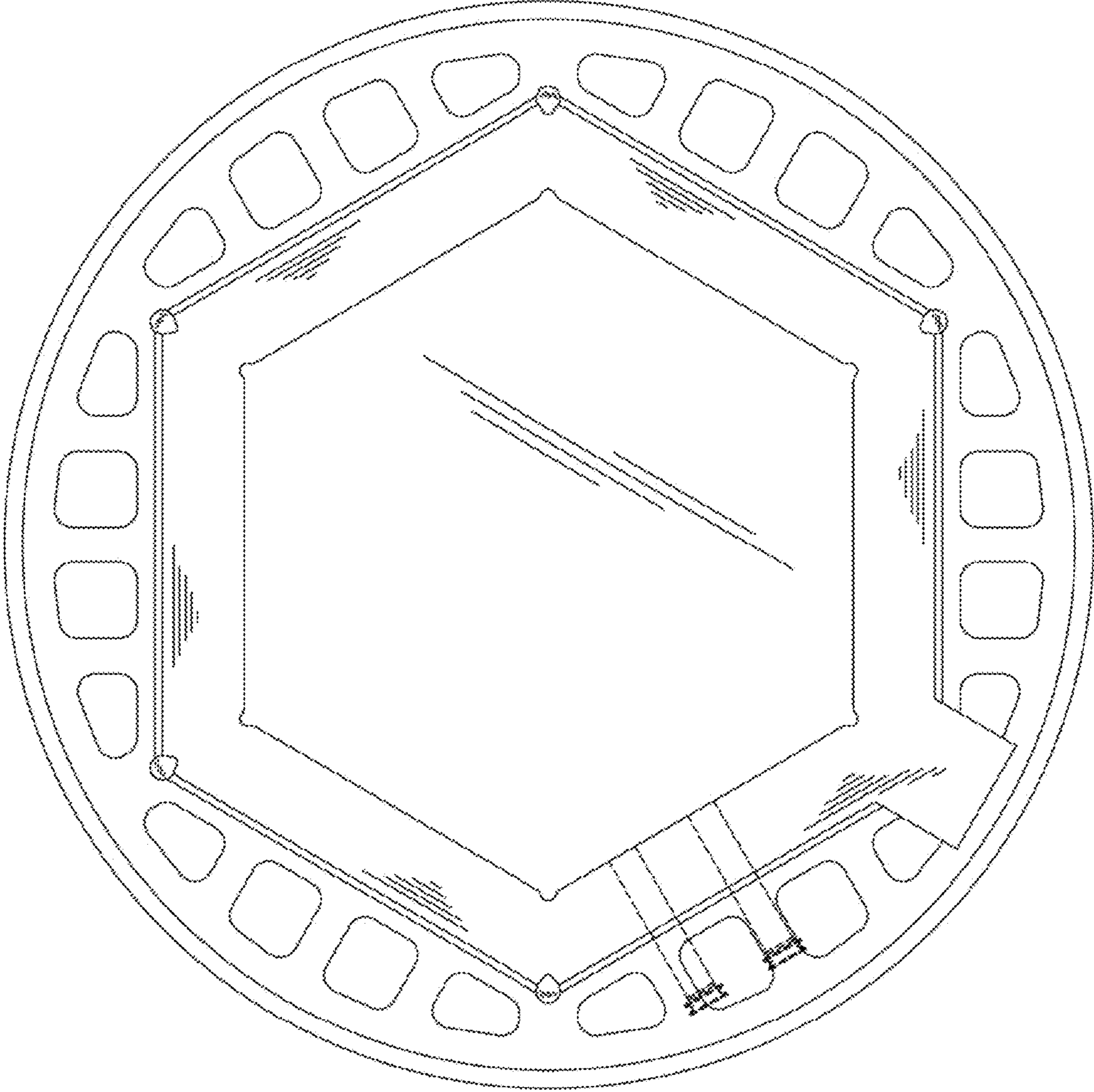

FIG. 1

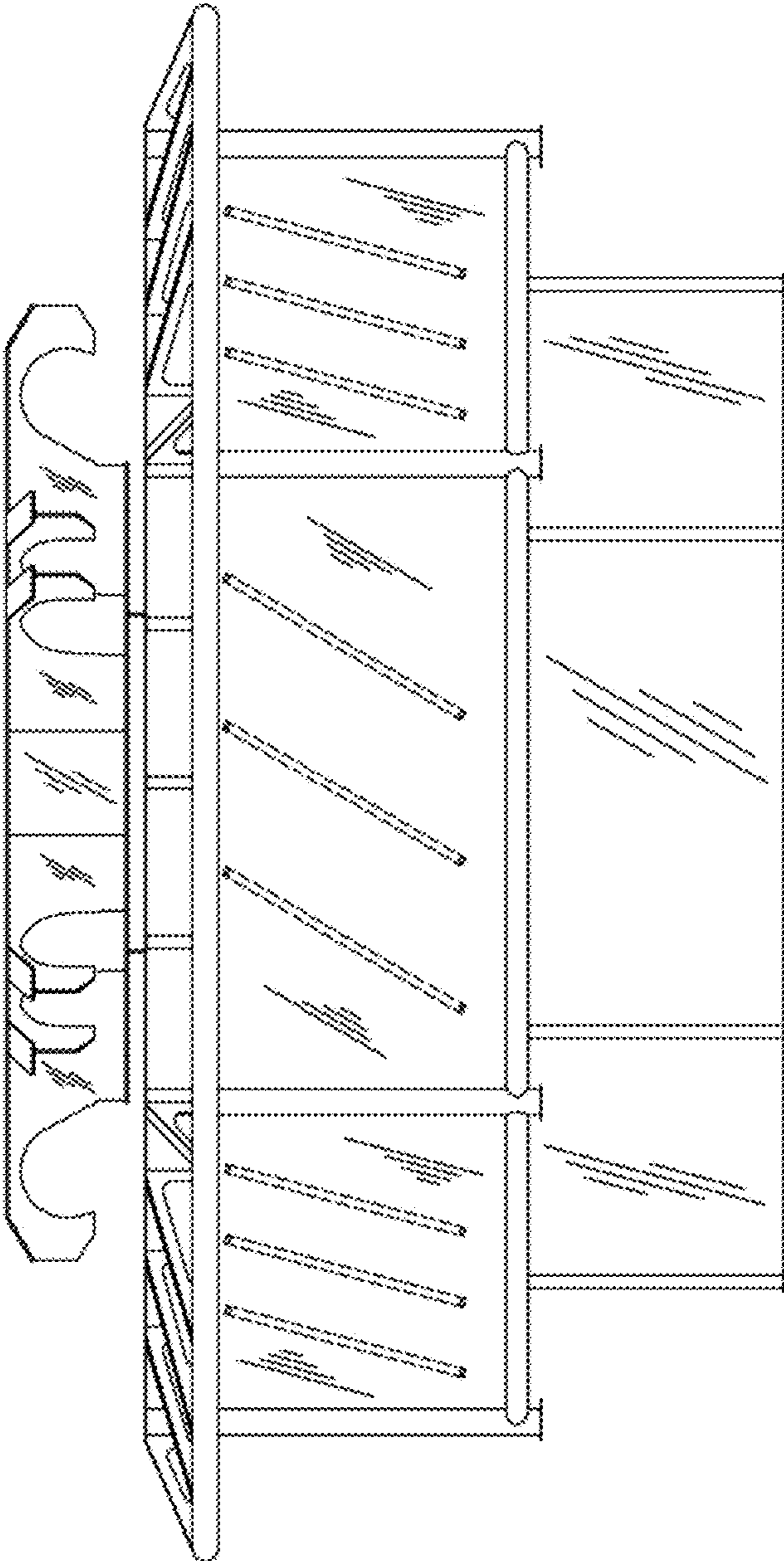

FIG. 2

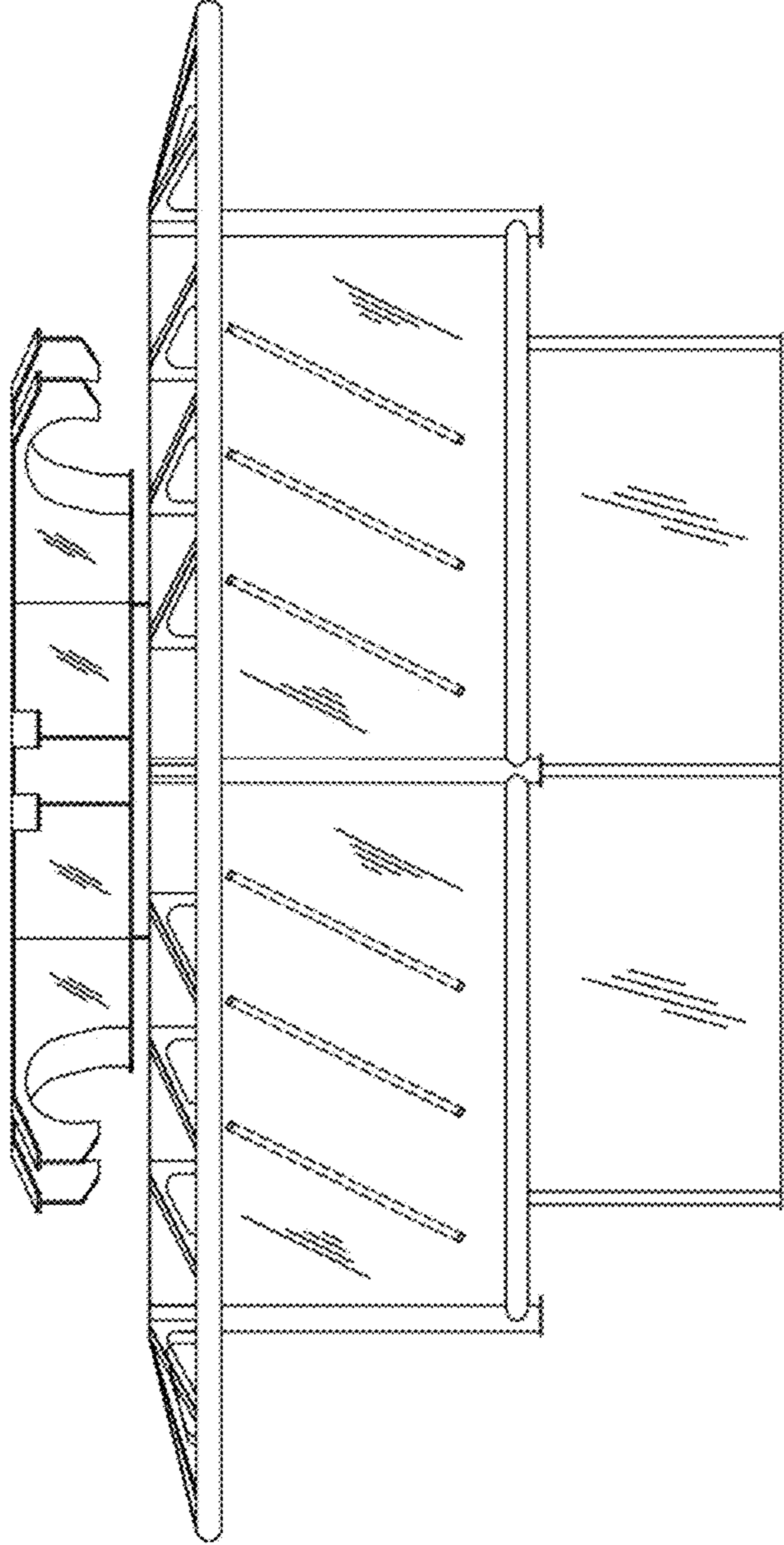

FIG. 3

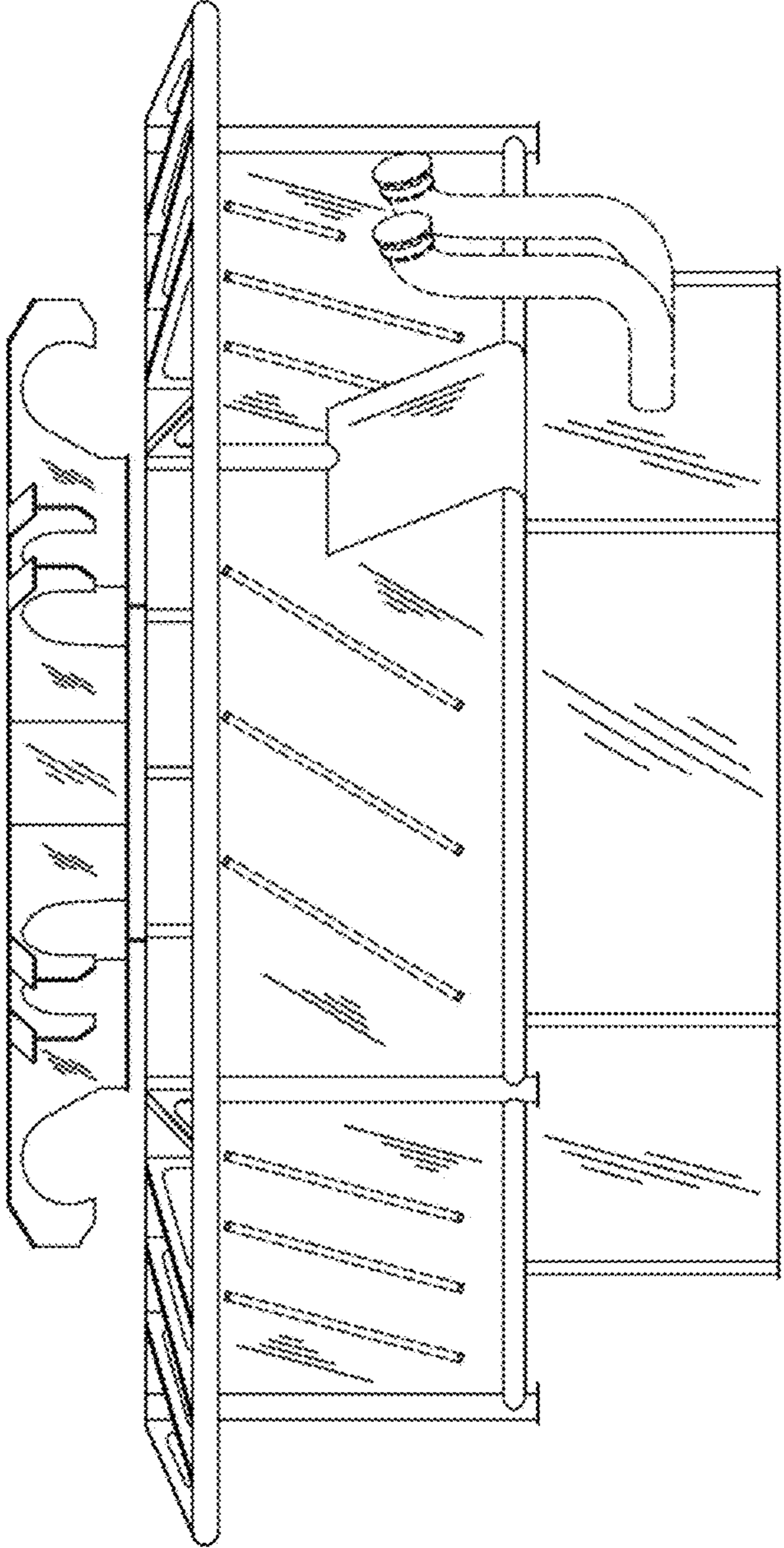

FIG. 4

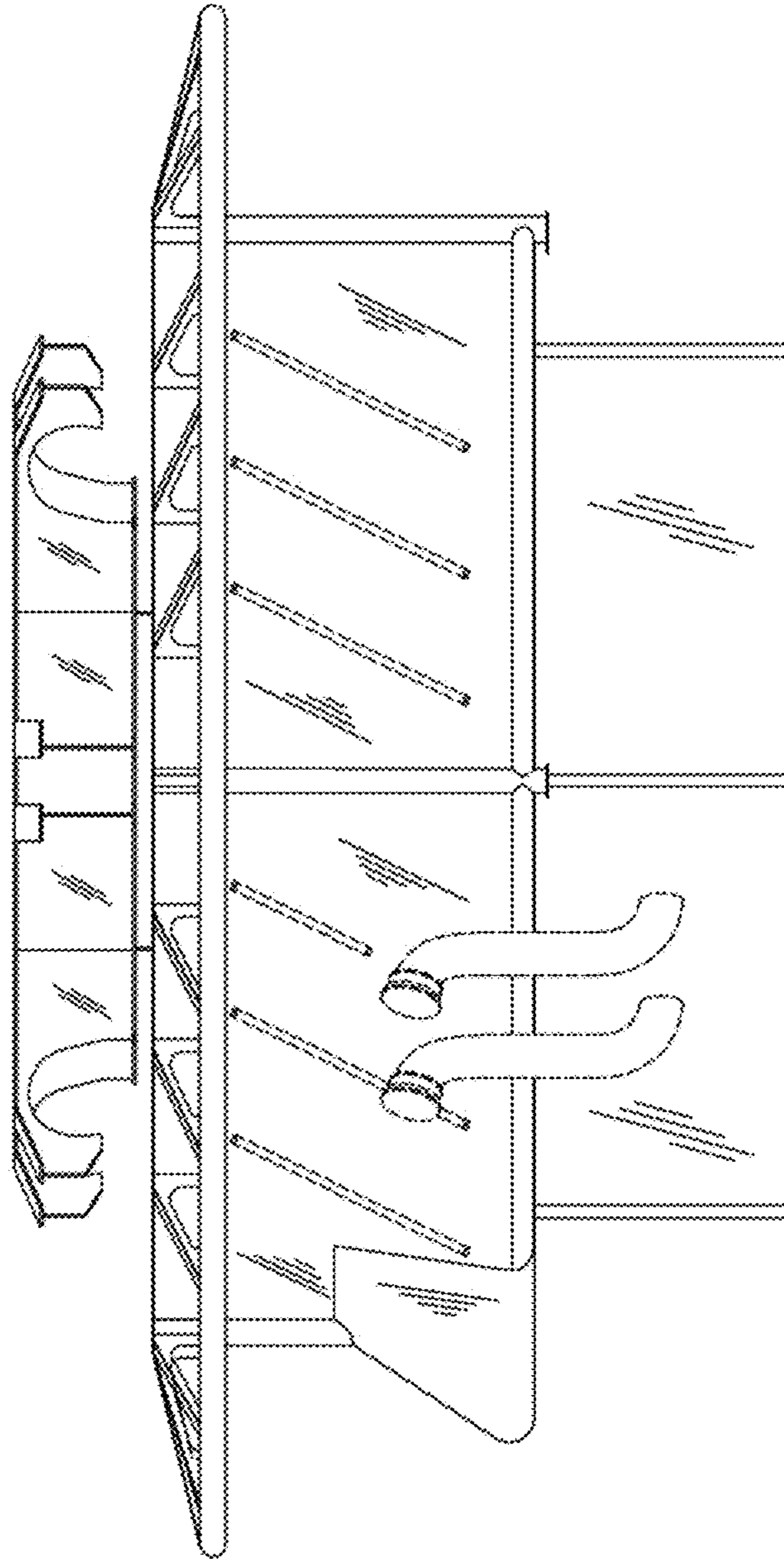

FIG. 5

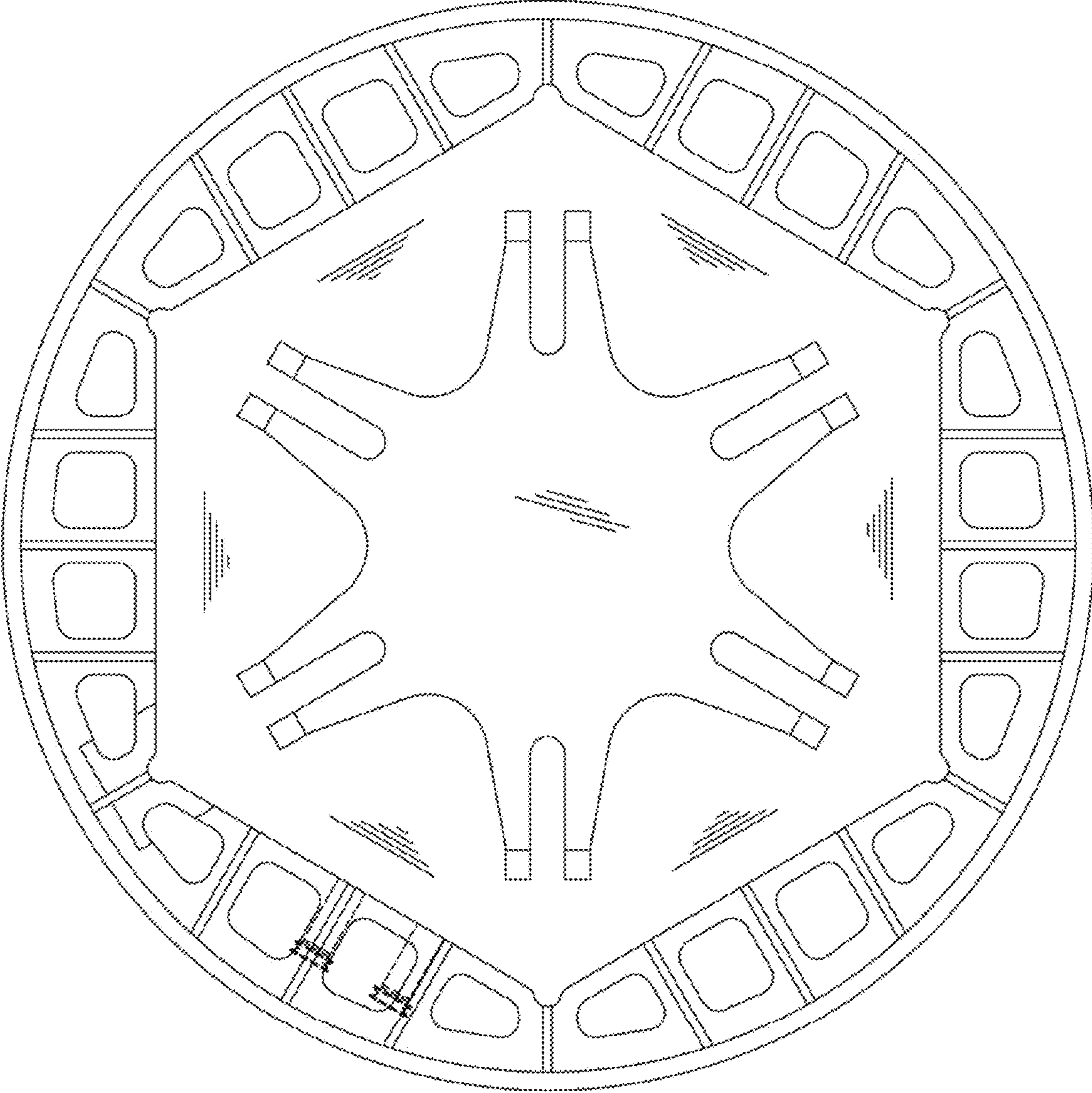

FIG. 6

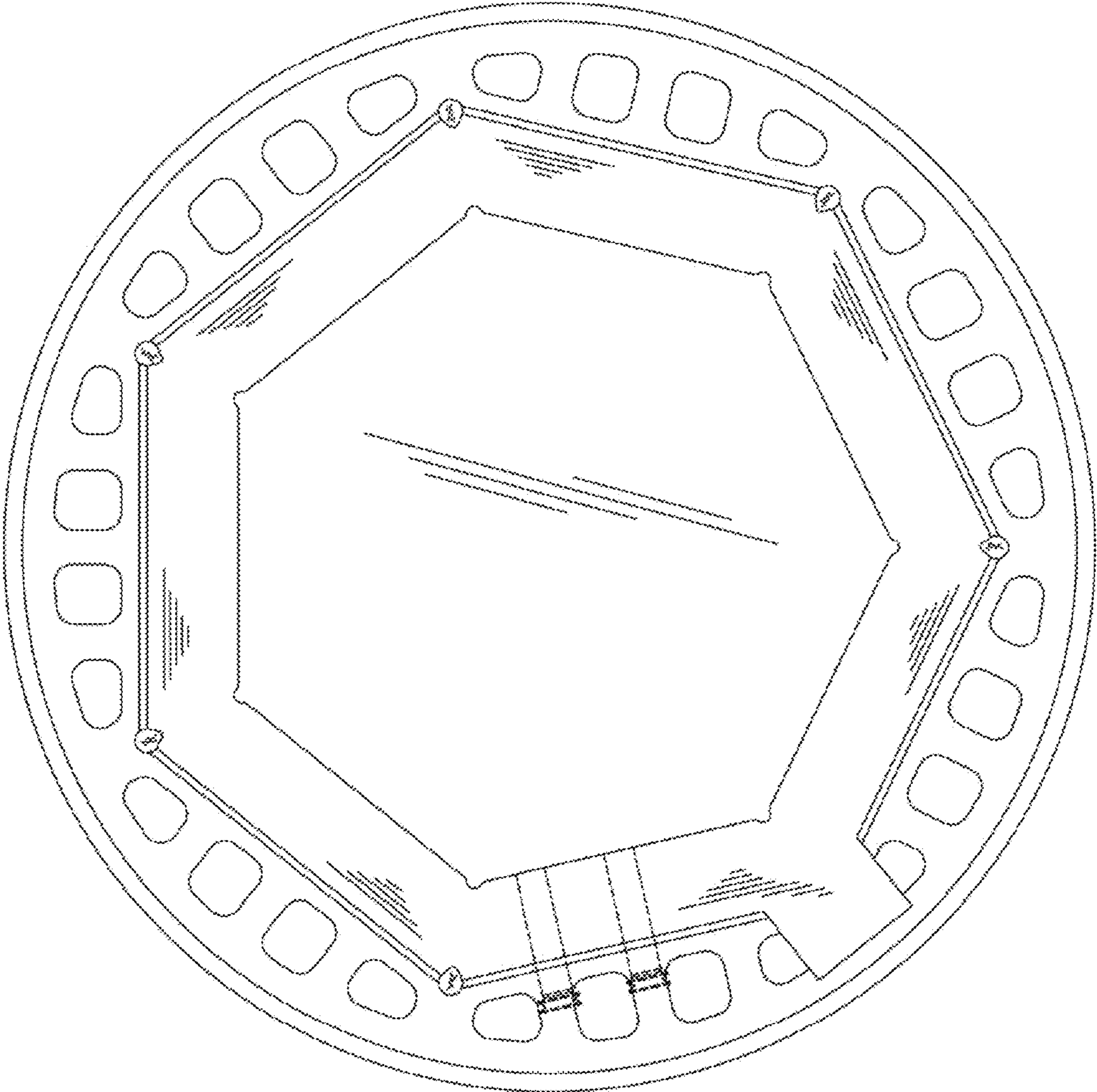

FIG. 7

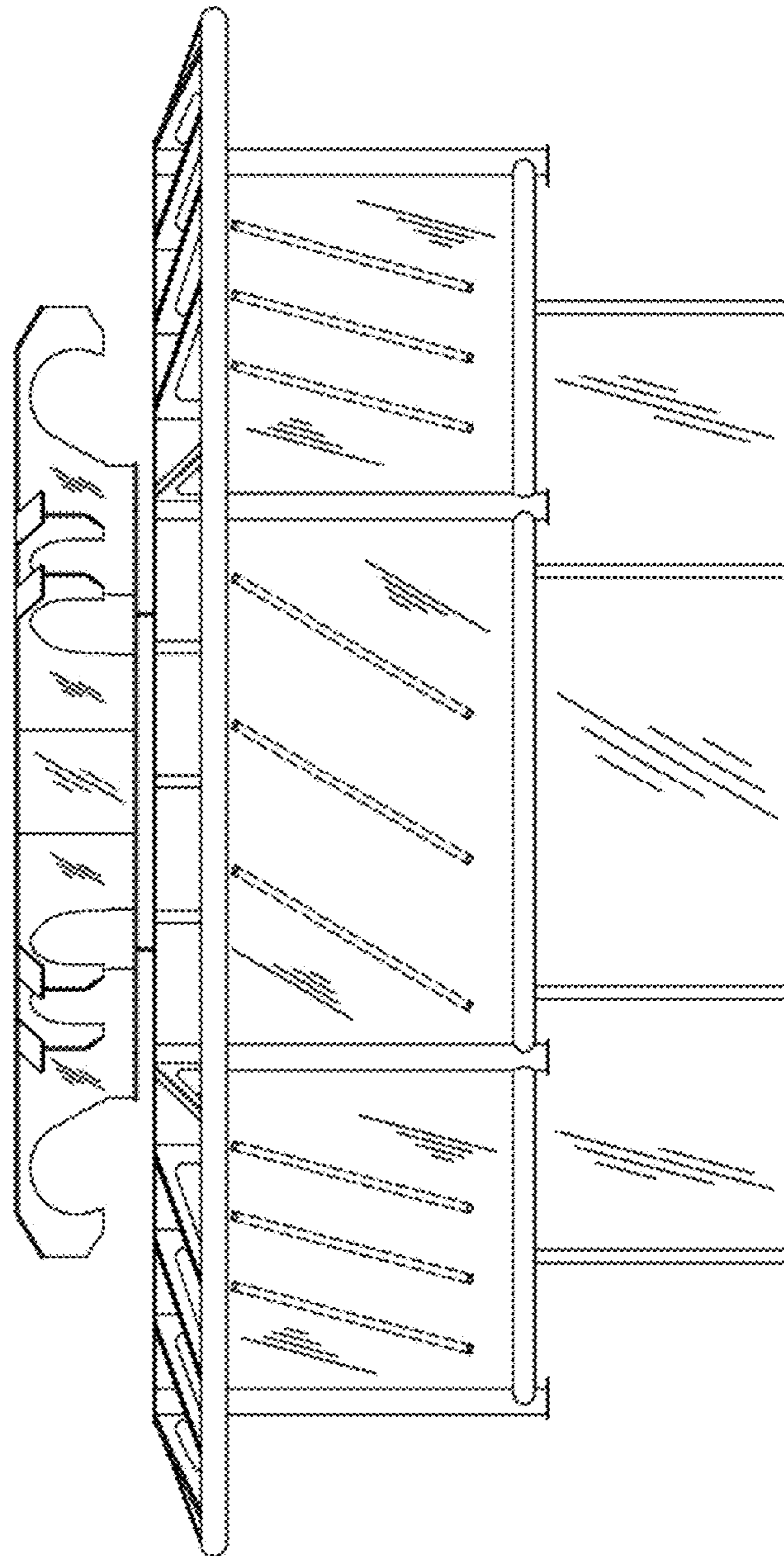

FIG. 8

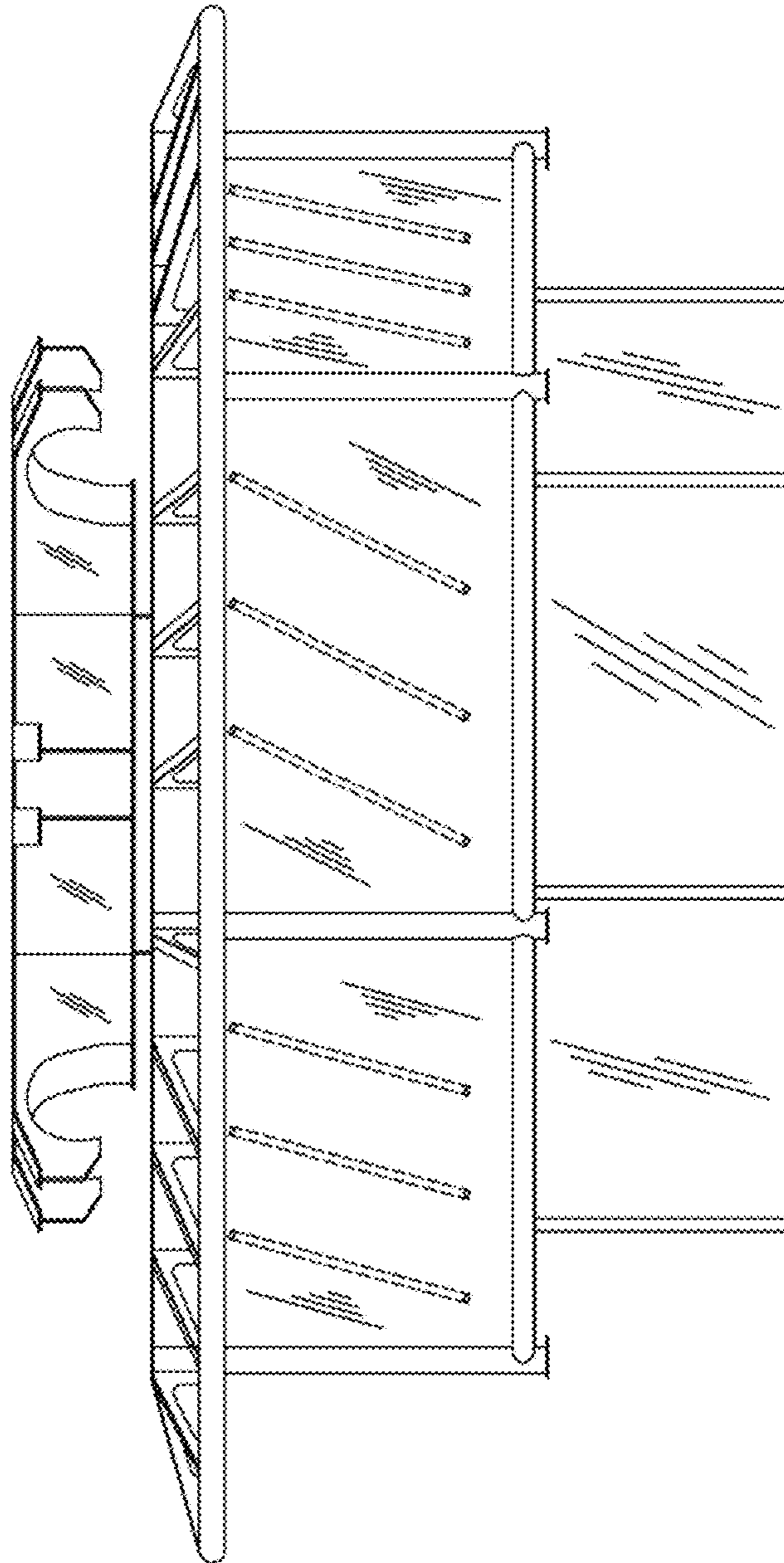

FIG. 9

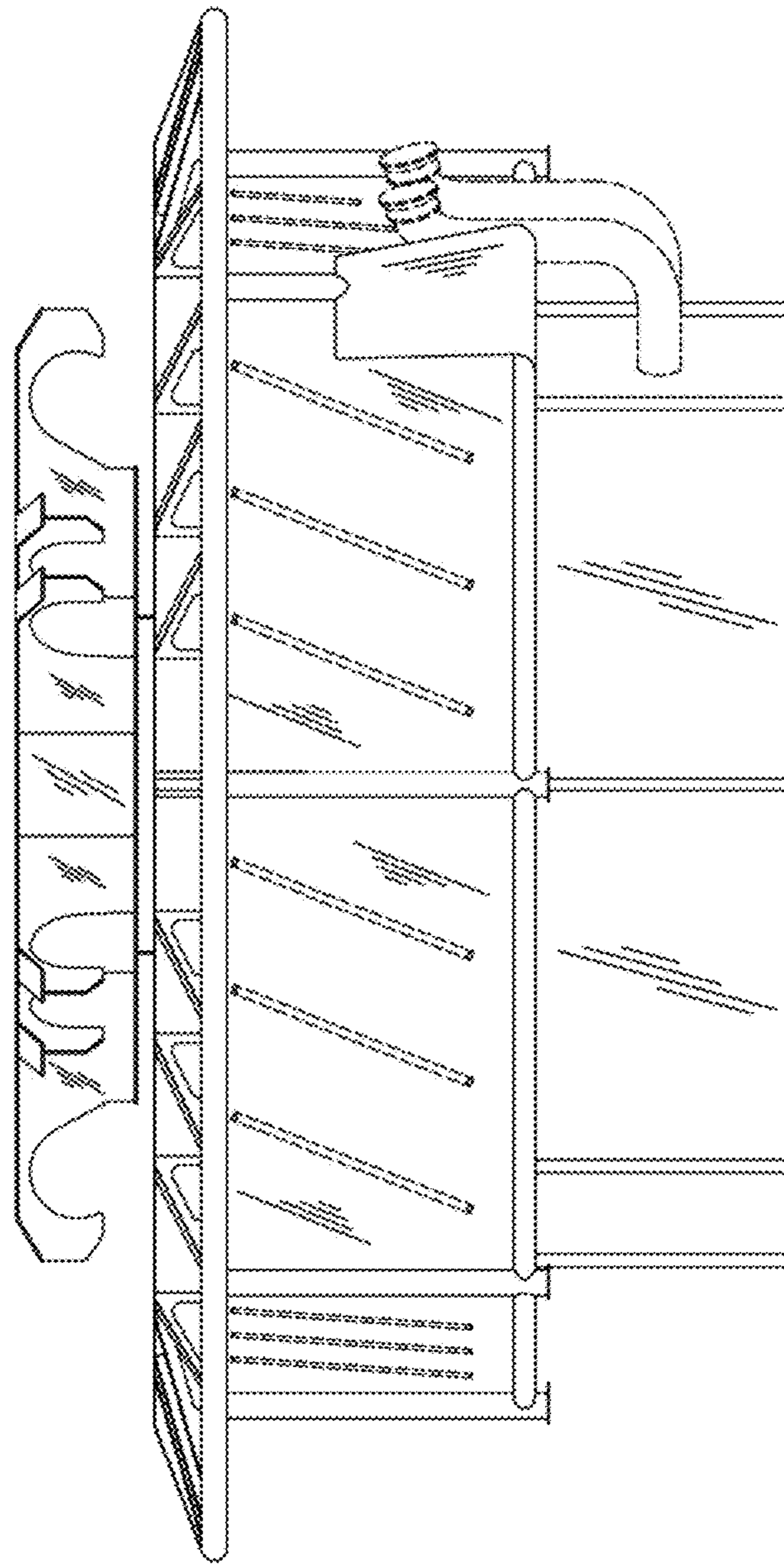

FIG. 10

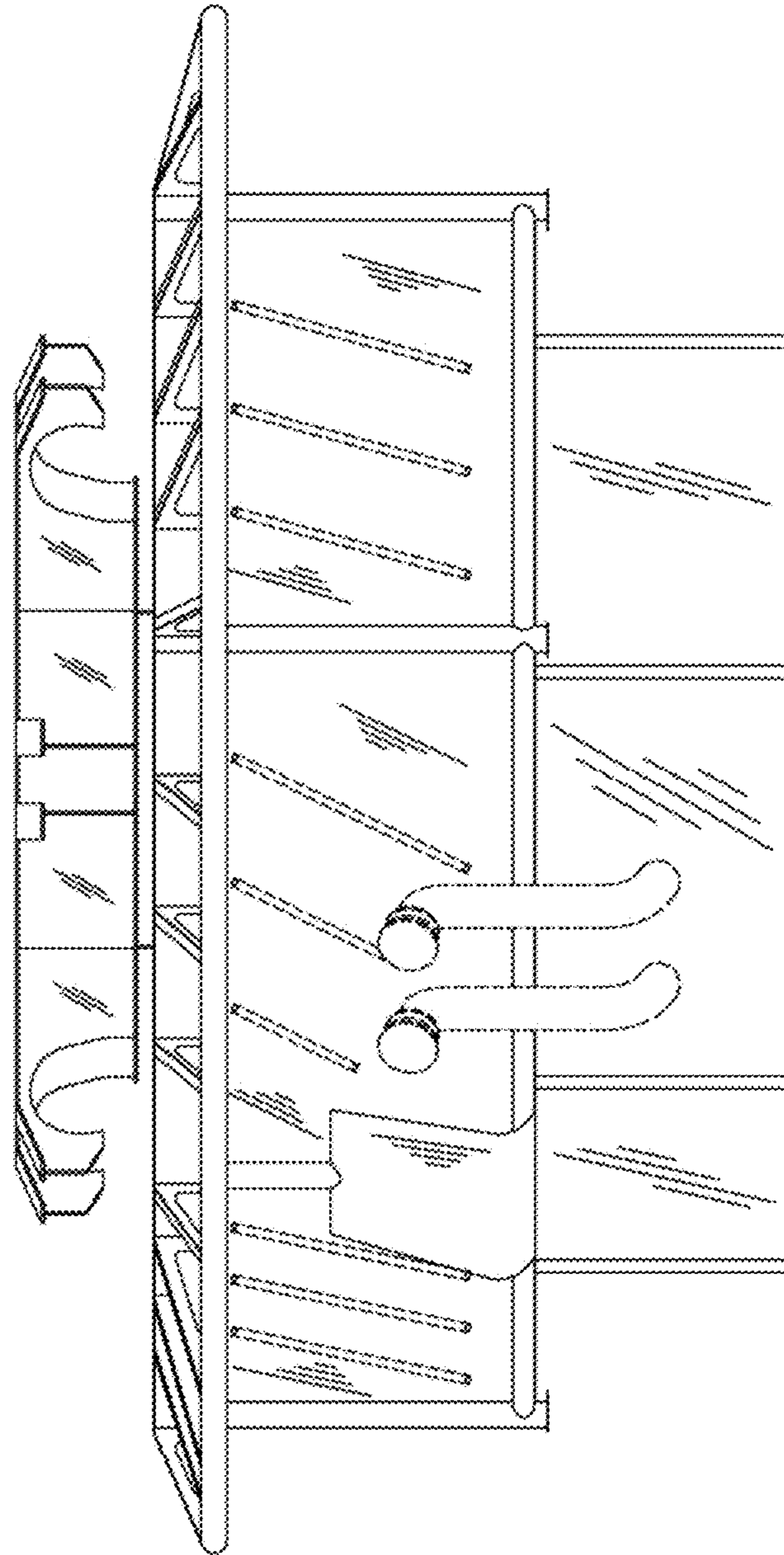

FIG. 11

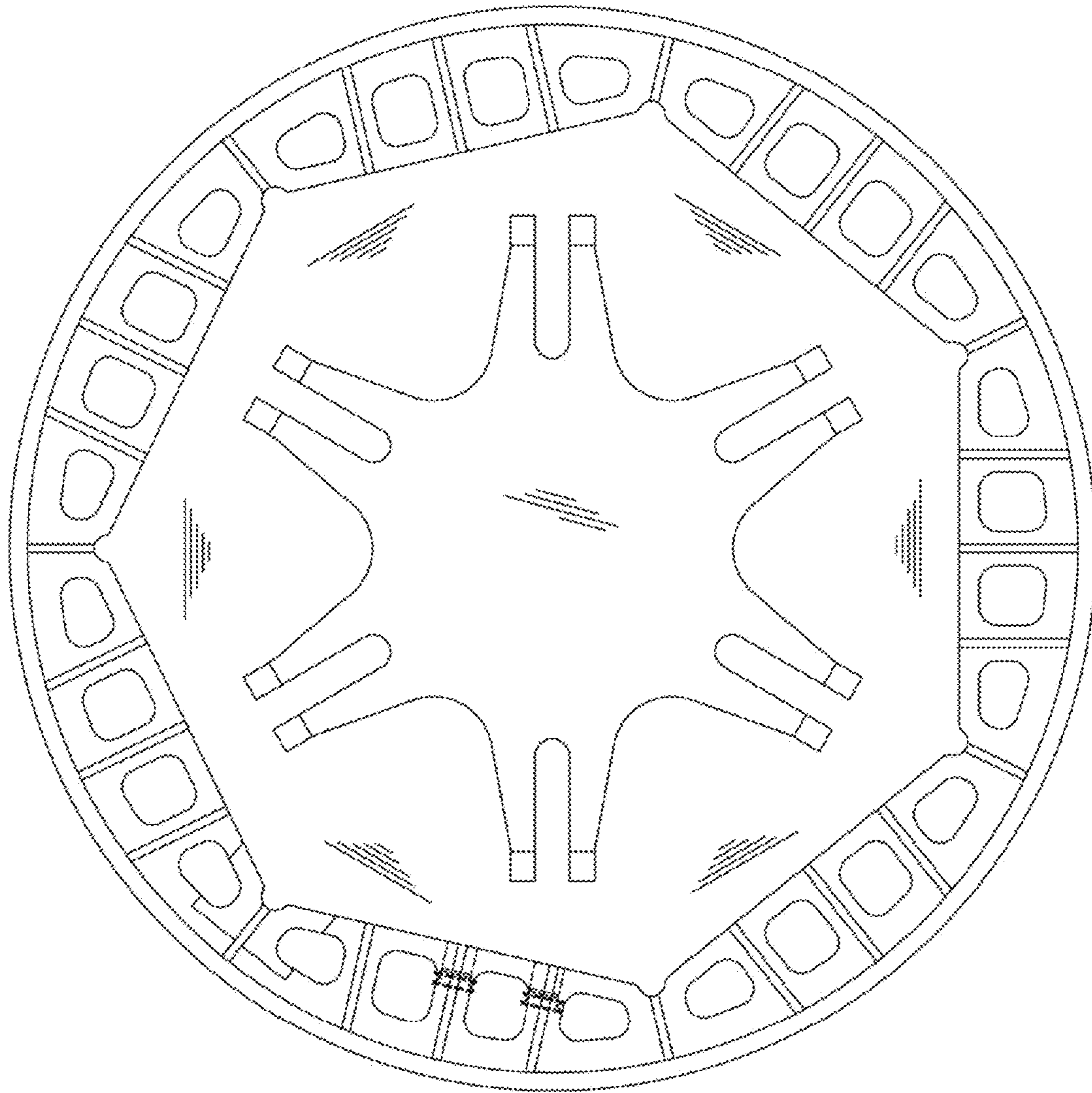

FIG. 12

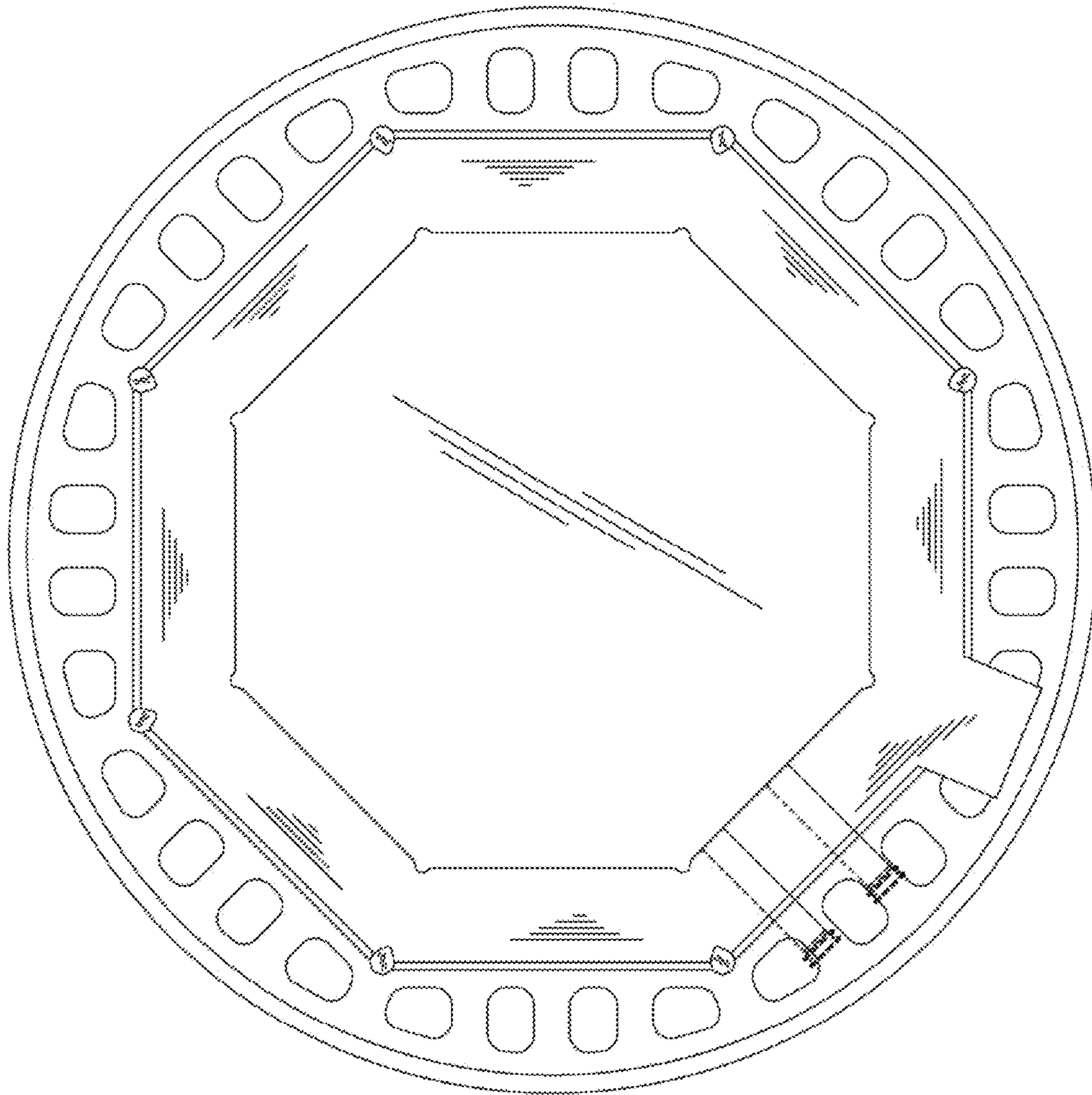

FIG. 13

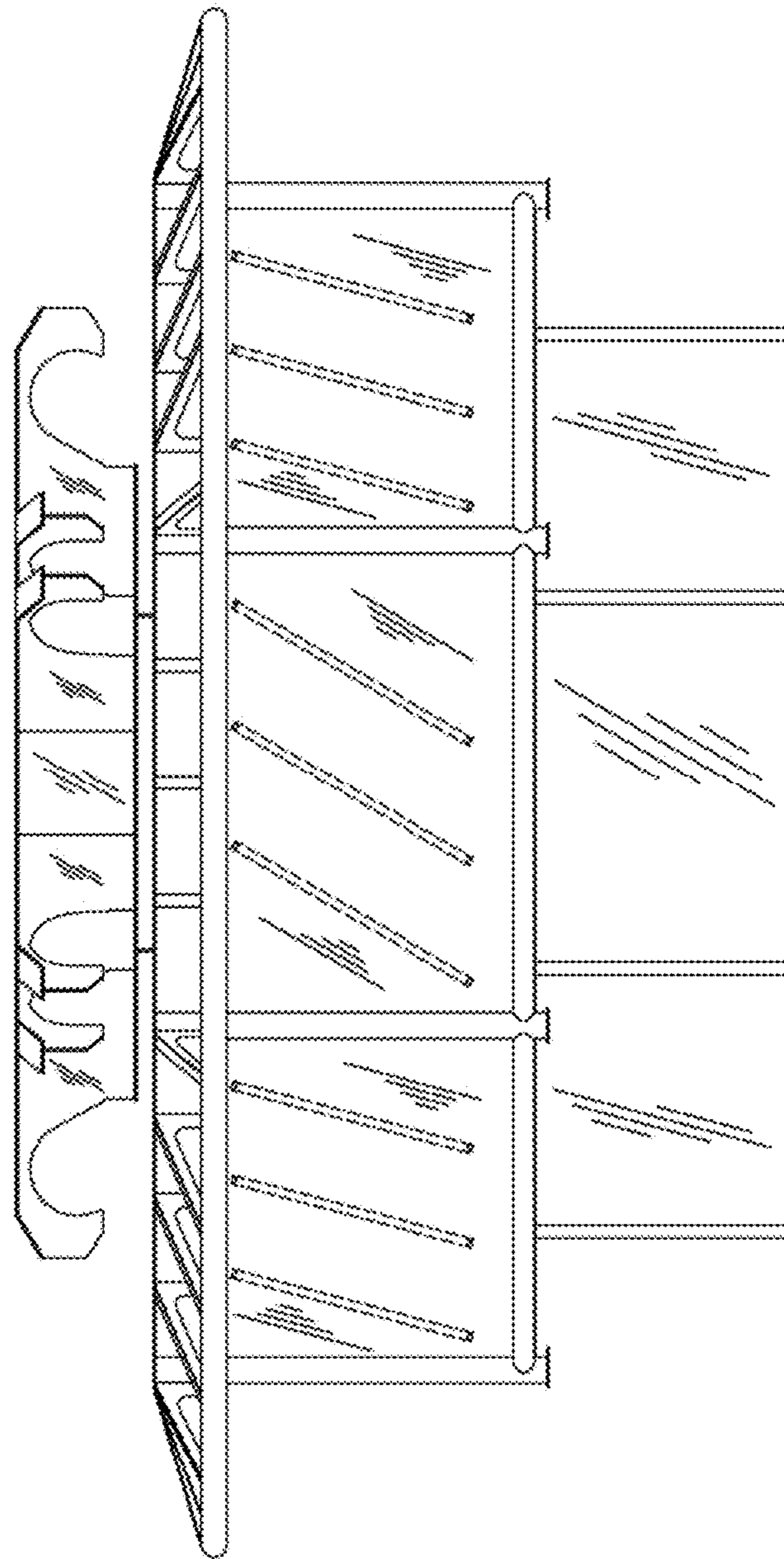

FIG. 14

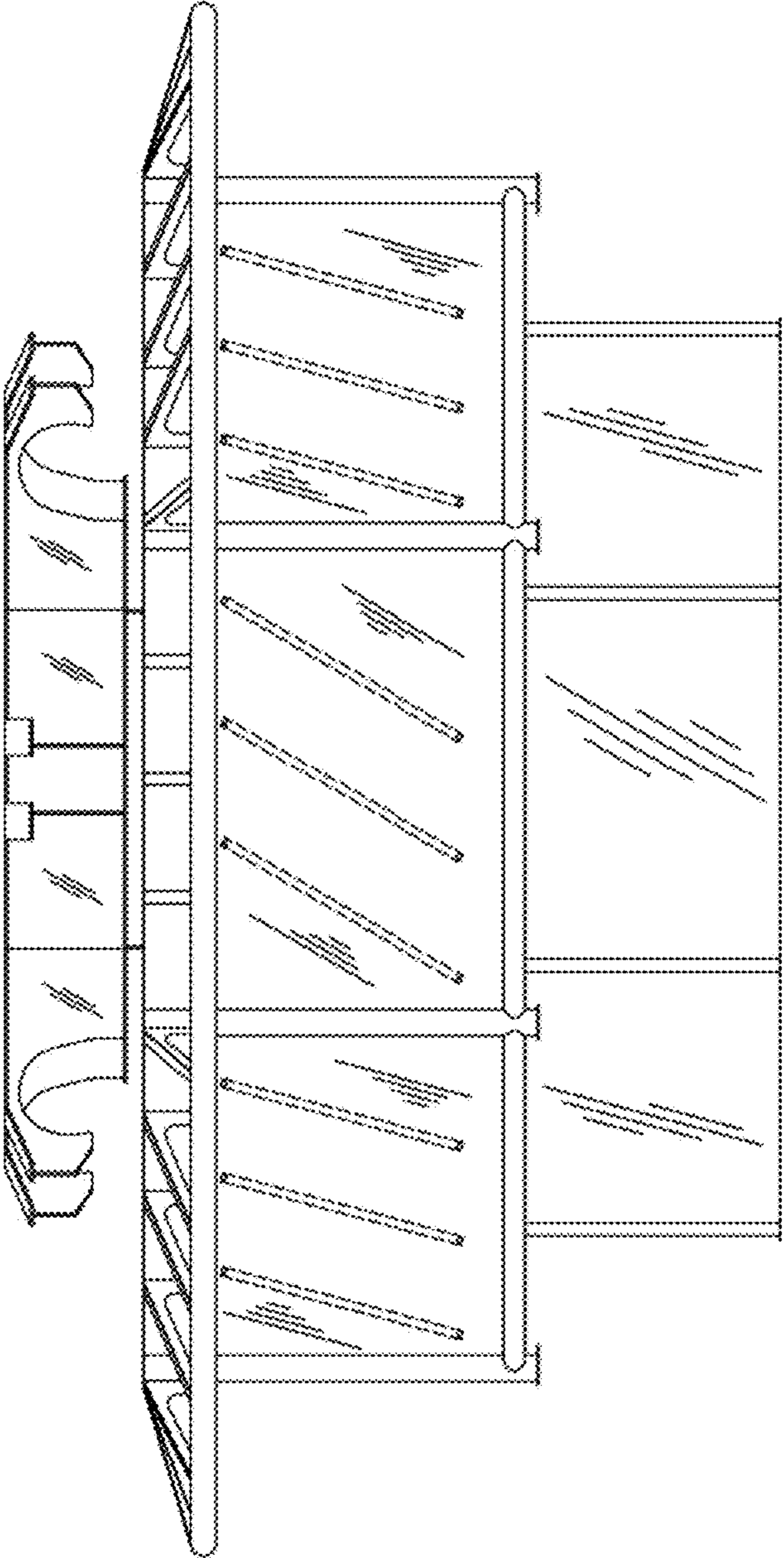

FIG. 15

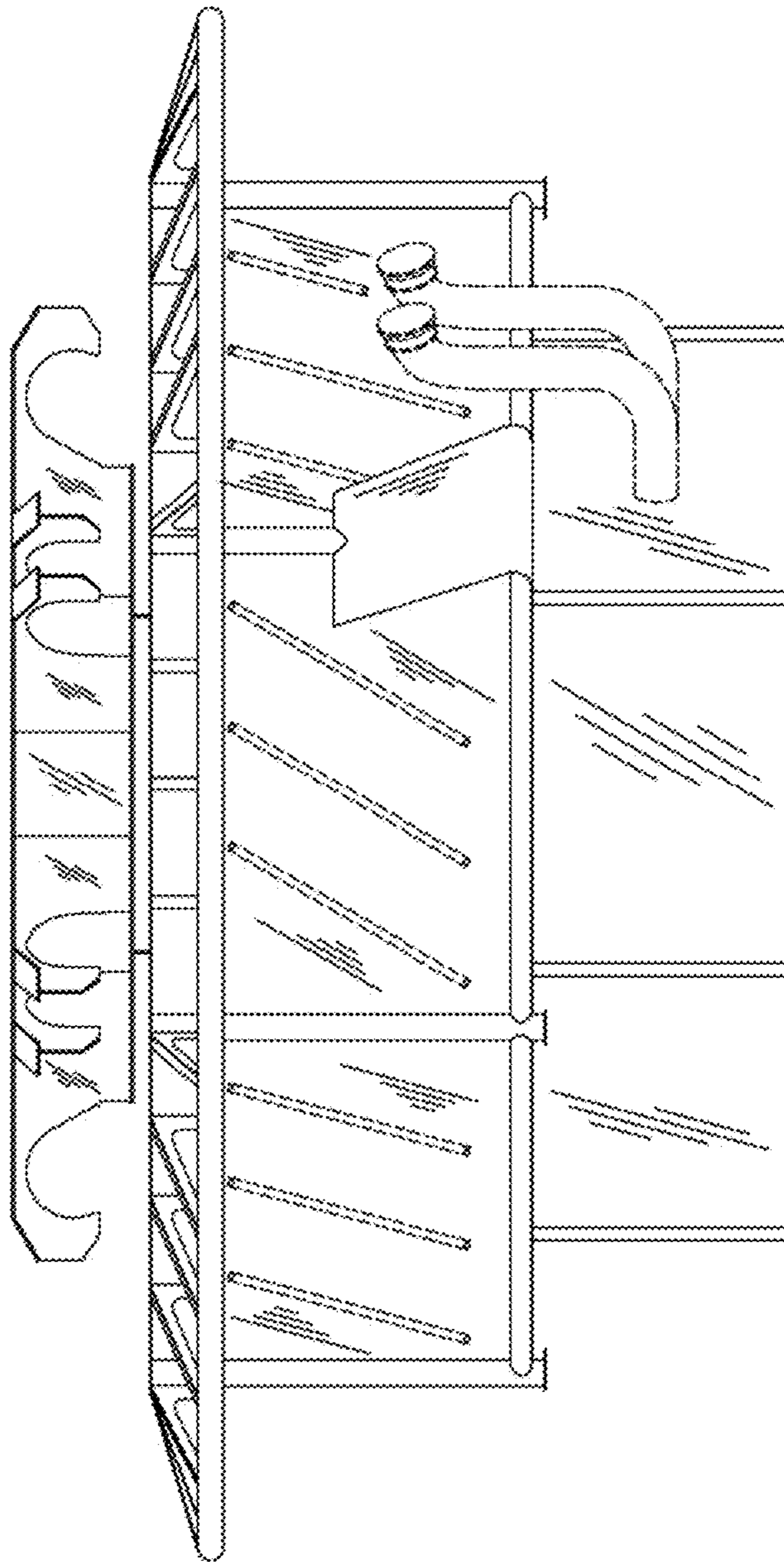

FIG. 16

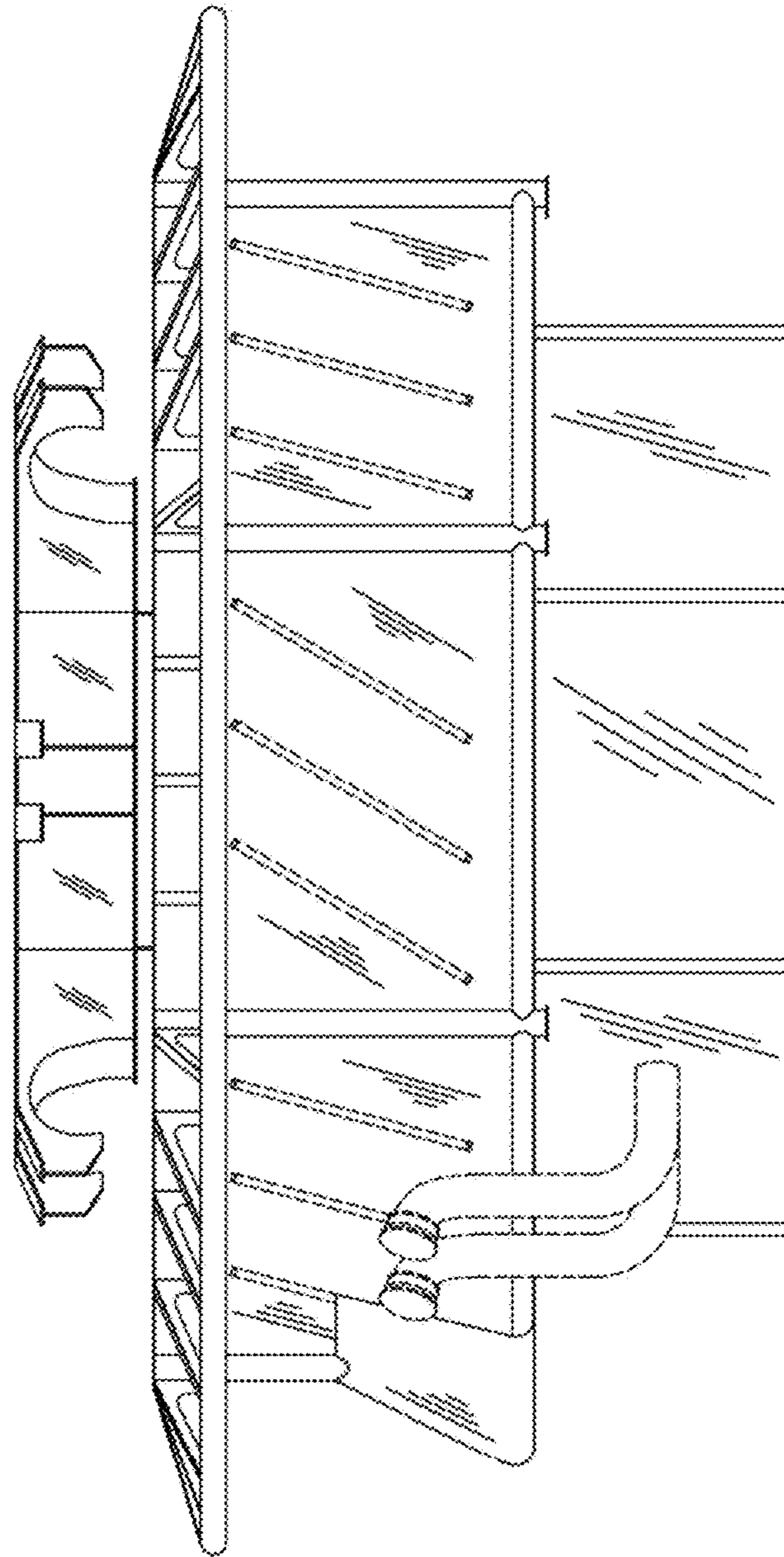

FIG. 17

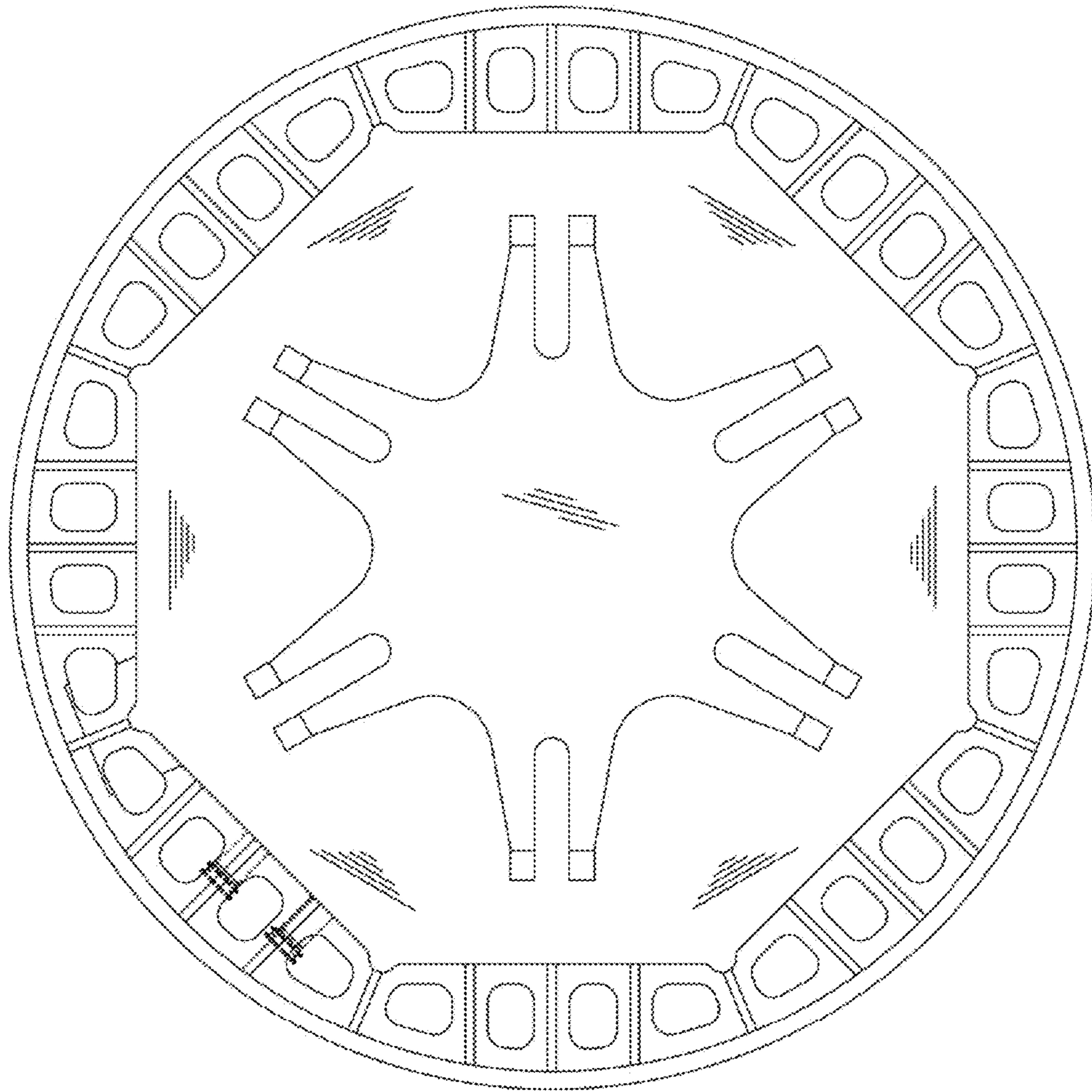

FIG. 18

UNITED STATES PATENT AND TRADEMARK OFFICE
CERTIFICATE OF CORRECTION

PATENT NO. : D700,852 S
APPLICATION NO. : 29/440107
DATED : March 11, 2014
INVENTOR(S) : Daniel Urs Winkler

Page 1 of 1

It is certified that error appears in the above-identified patent and that said Letters Patent is hereby corrected as shown below:

On the Title Page, Assignee Item (73):

Please delete "Wilson" and insert --Wison-- therefor.

Signed and Sealed this
Fifteenth Day of July, 2014



Michelle K. Lee
Deputy Director of the United States Patent and Trademark Office