



US00D700850S

(12) **United States Design Patent**  
**Winkler**

(10) **Patent No.:** **US D700,850 S**  
(45) **Date of Patent:** **\*\* Mar. 11, 2014**

(54) **BUOY**

(56) **References Cited**

(71) Applicant: **Wison Offshore & Marine (USA), Inc.**,  
Houston, TX (US)

U.S. PATENT DOCUMENTS

(72) Inventor: **Daniel Urs Winkler**, Richmond, TX  
(US)

4,279,047 A \* 7/1981 van Heijst ..... 441/5  
D310,180 S \* 8/1990 Etkin ..... D10/107  
6,074,259 A \* 6/2000 Lastrajoli et al. .... 441/1  
D602,389 S \* 10/2009 Gilman et al. .... D10/107

(73) Assignee: **Wison Offshore & Marine (USA), Inc.**,  
Houston, TX (US)

\* cited by examiner

(\*\*) Term: **14 Years**

*Primary Examiner* — George D Kirschbaum  
(74) *Attorney, Agent, or Firm* — Patterson & Sheridan, LLP

(21) Appl. No.: **29/440,091**

(57) **CLAIM**  
The ornamental design for a buoy, as shown and described.

(22) Filed: **Dec. 19, 2012**

**DESCRIPTION**

**Related U.S. Application Data**

(62) Division of application No. 29/412,902, filed on Feb.  
9, 2012, now Pat. No. Des. 681,492.

FIG. 1 is a top plan view of a first embodiment of a buoy  
showing my new design;  
FIG. 2 is a front elevational view thereof;  
FIG. 3 is a left side elevational view thereof;  
FIG. 4 is a rear elevational view thereof;  
FIG. 5 is a right side elevational view thereof;  
FIG. 6 is a bottom plan view thereof;  
FIG. 7 is a top plan view of a second embodiment of the buoy;  
FIG. 8 is a front elevational view thereof;  
FIG. 9 is a left side elevational view thereof;  
FIG. 10 is a rear elevational view thereof;  
FIG. 11 is a right side elevational view thereof; and,  
FIG. 12 is a bottom plan view thereof.

(51) **LOC (10) Cl.** ..... **10-05**

(52) **U.S. Cl.**  
USPC ..... **D10/107**

(58) **Field of Classification Search**  
USPC ..... D10/107; 441/1, 5  
See application file for complete search history.

The broken lines shown in the drawings illustrate environ-  
mental structure and form no part of the claimed design.

**1 Claim, 12 Drawing Sheets**

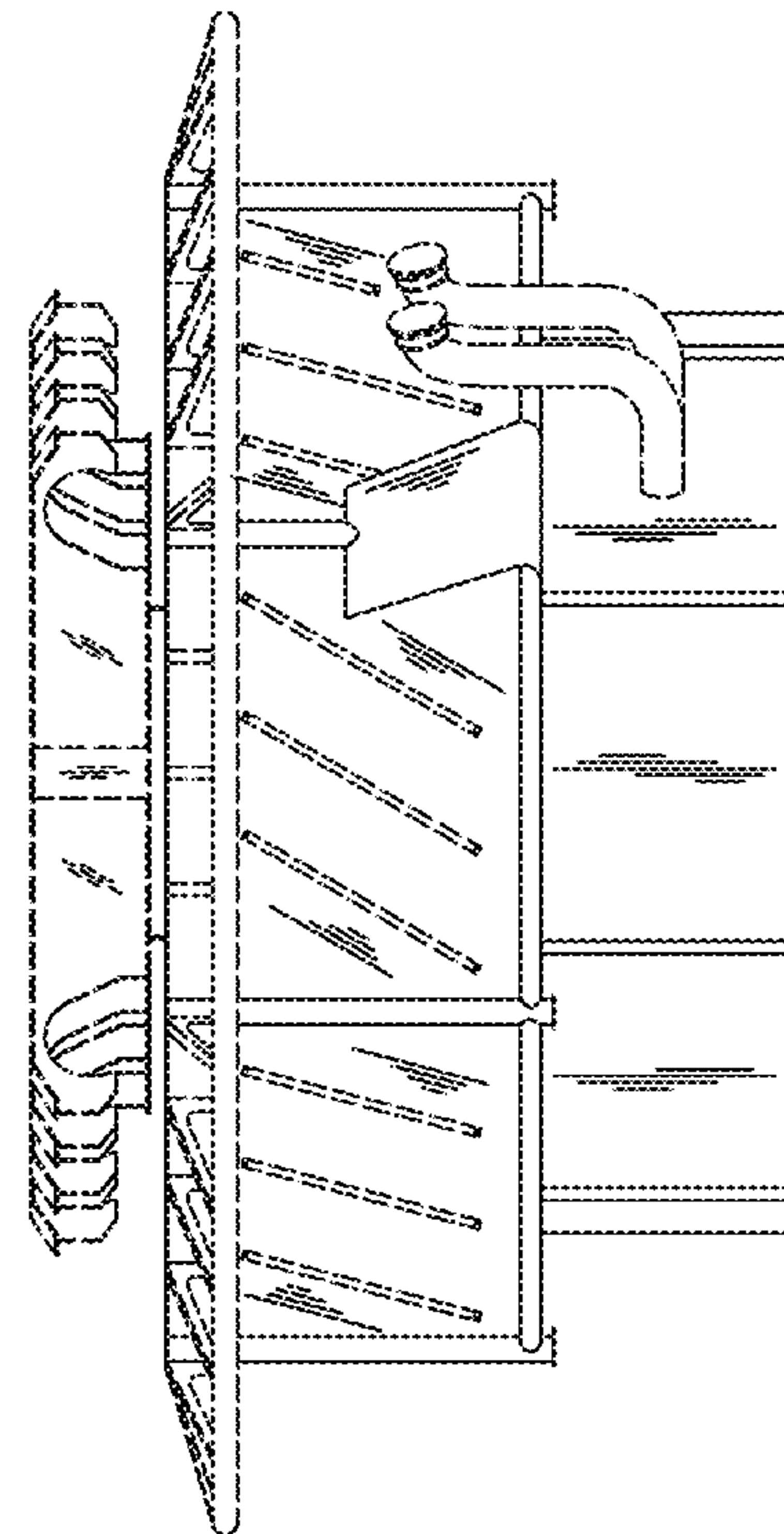
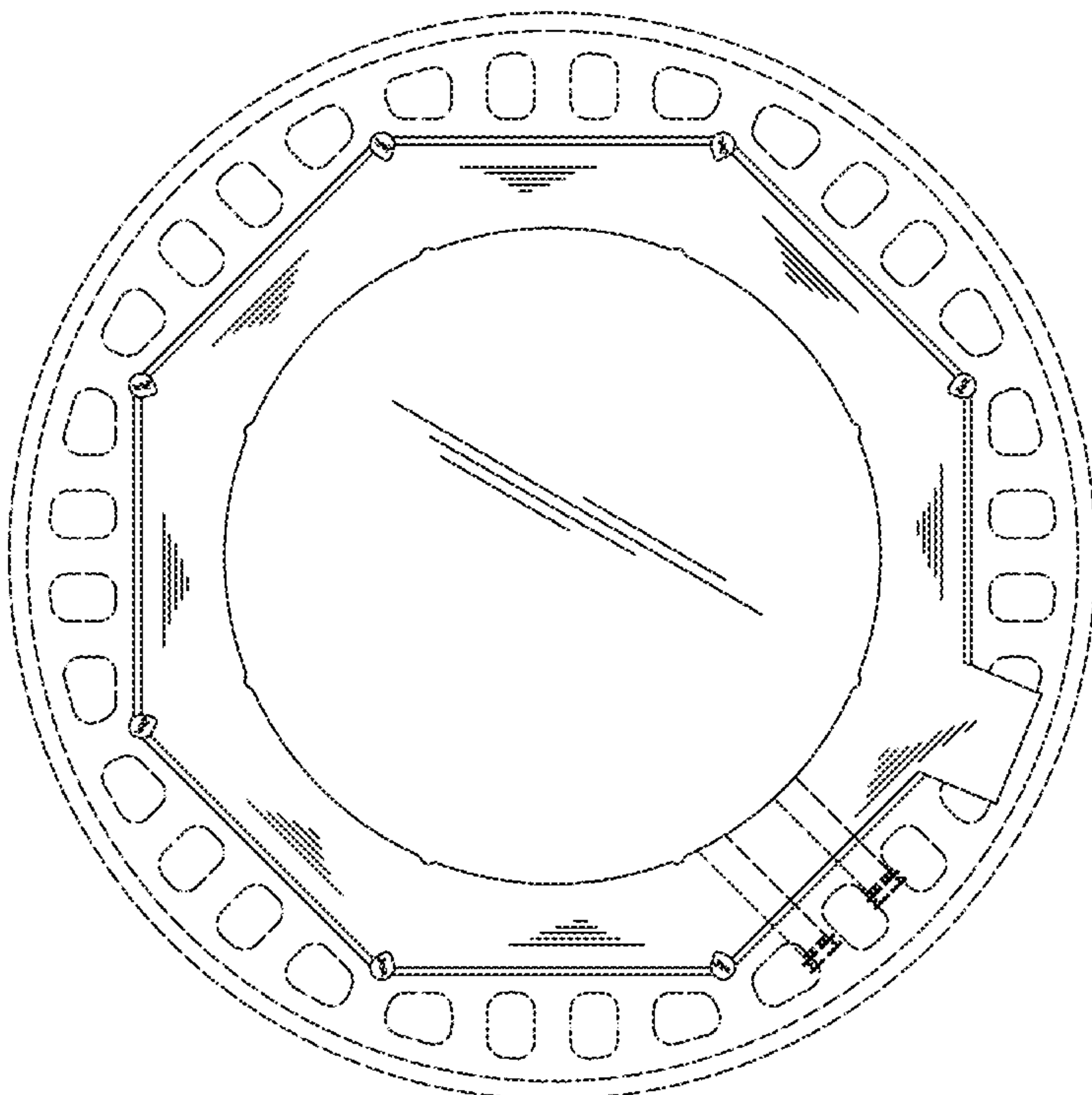

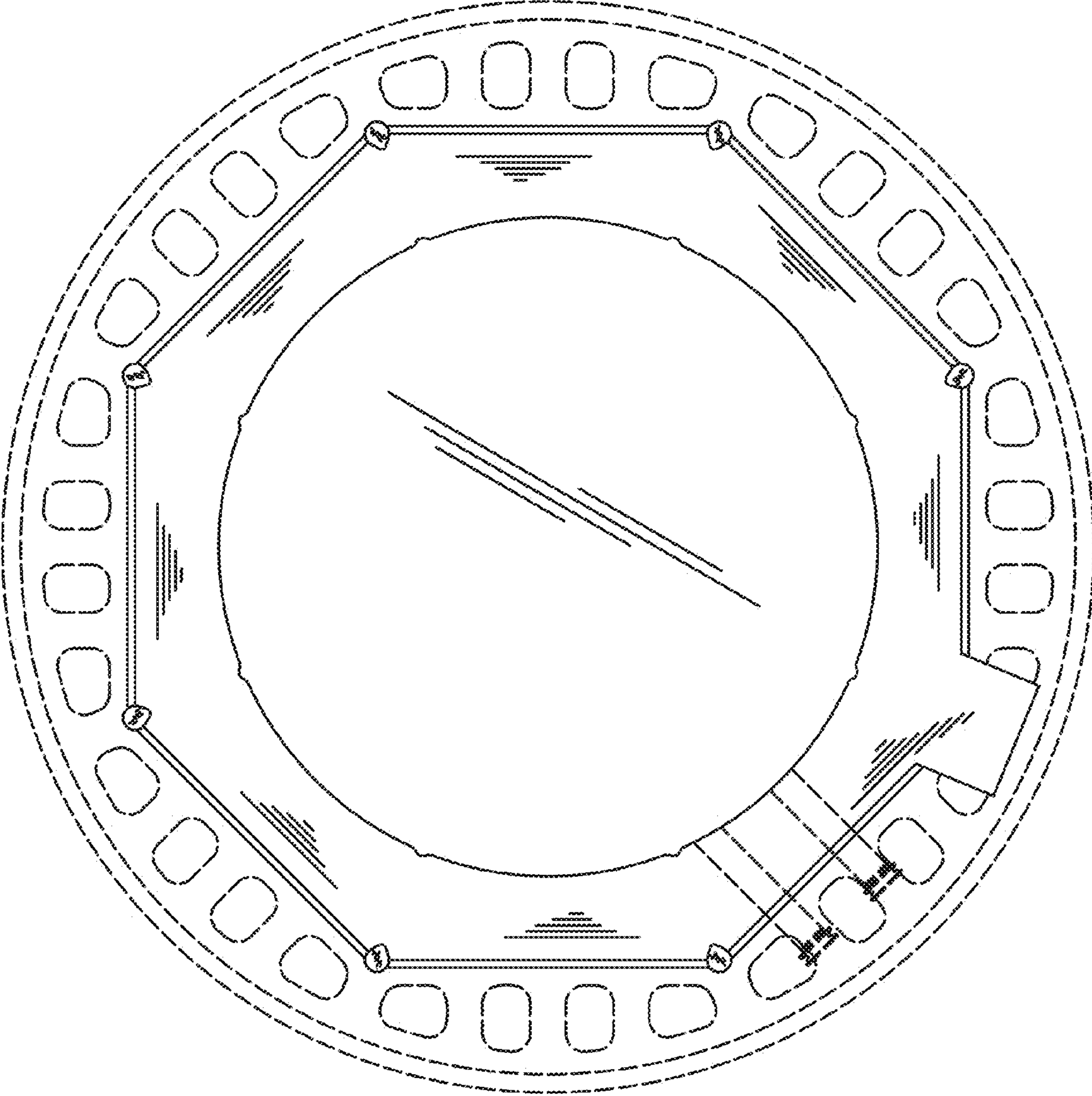

FIG. 1

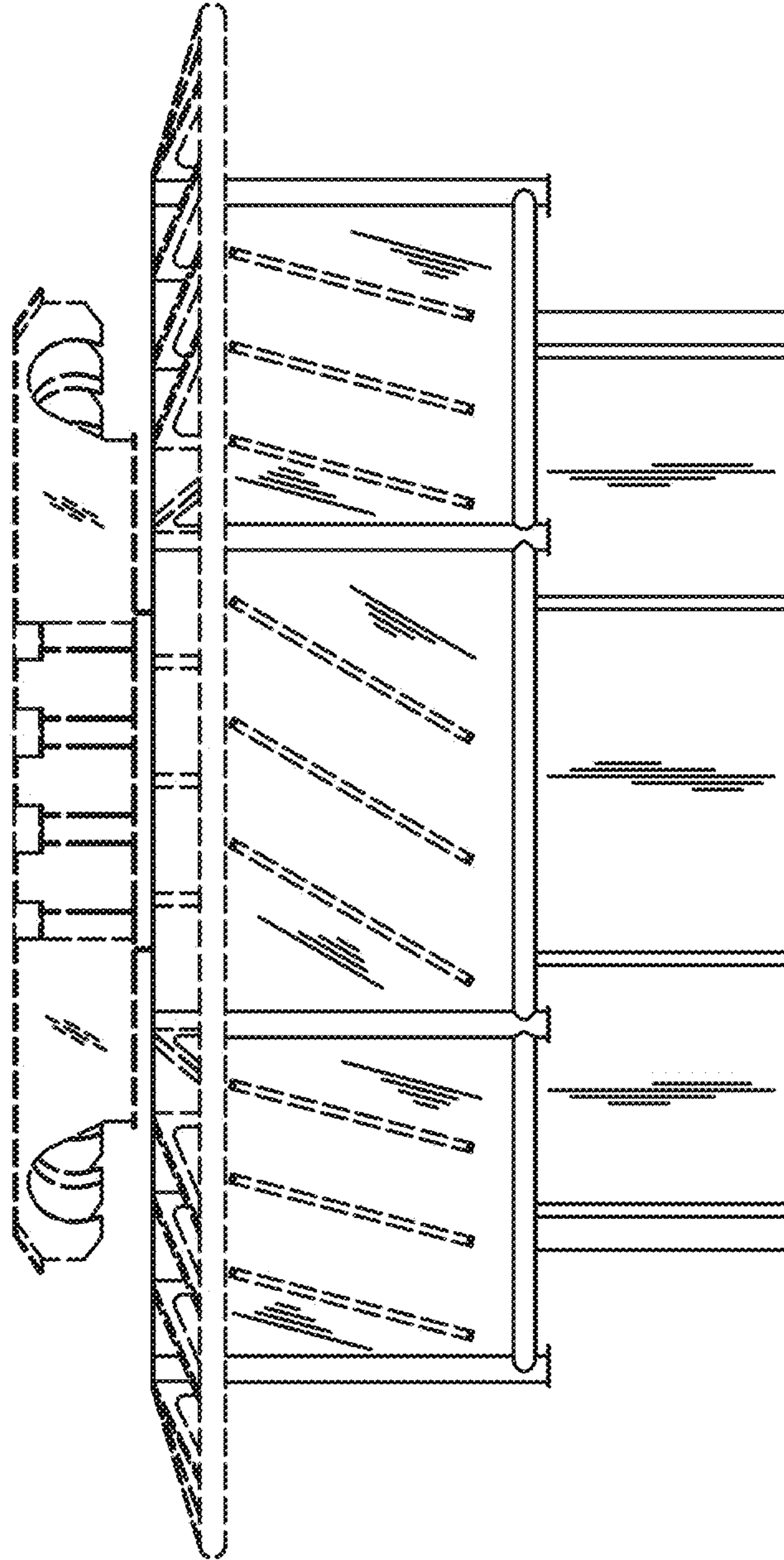

FIG. 2



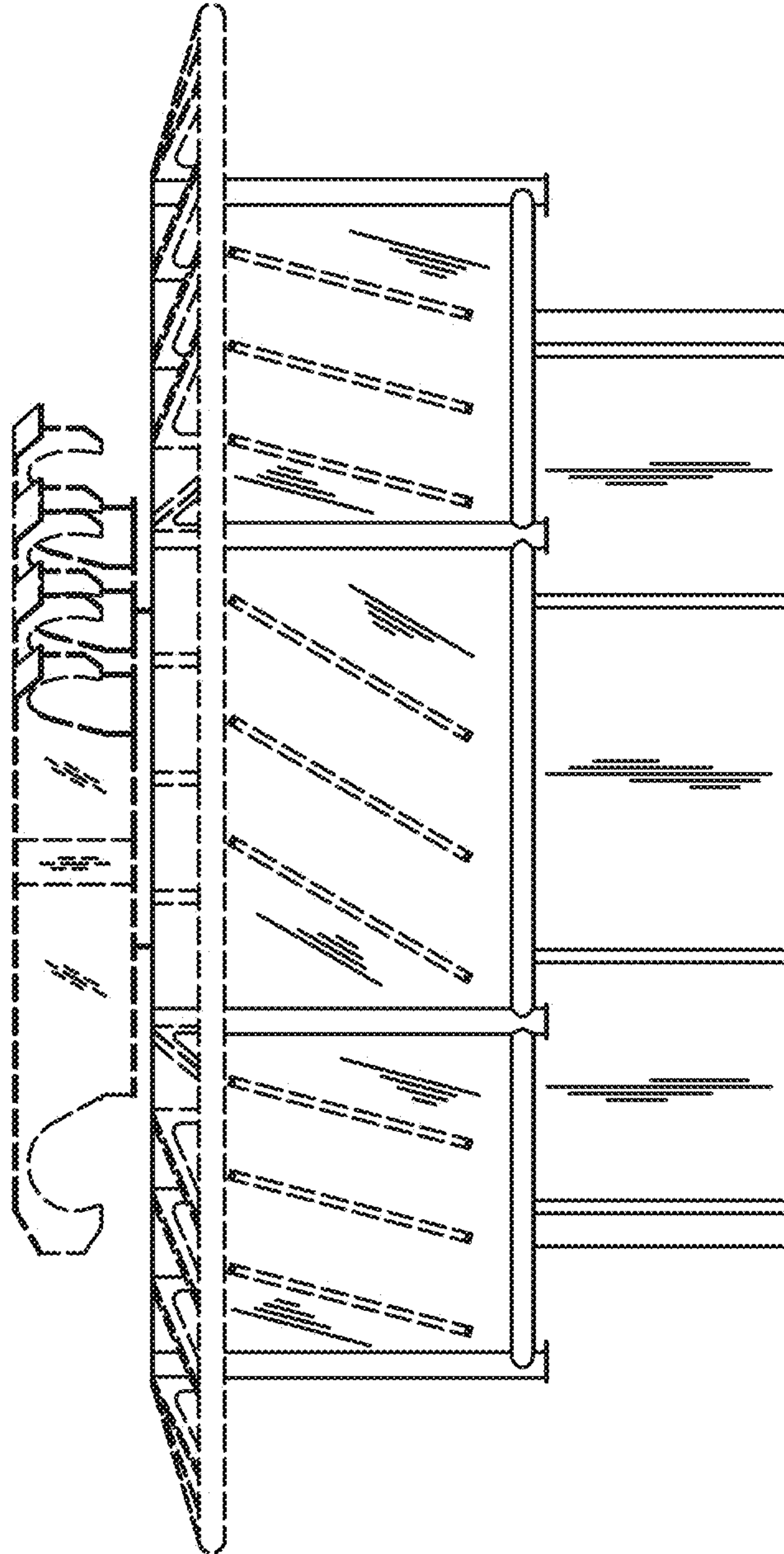

FIG. 3

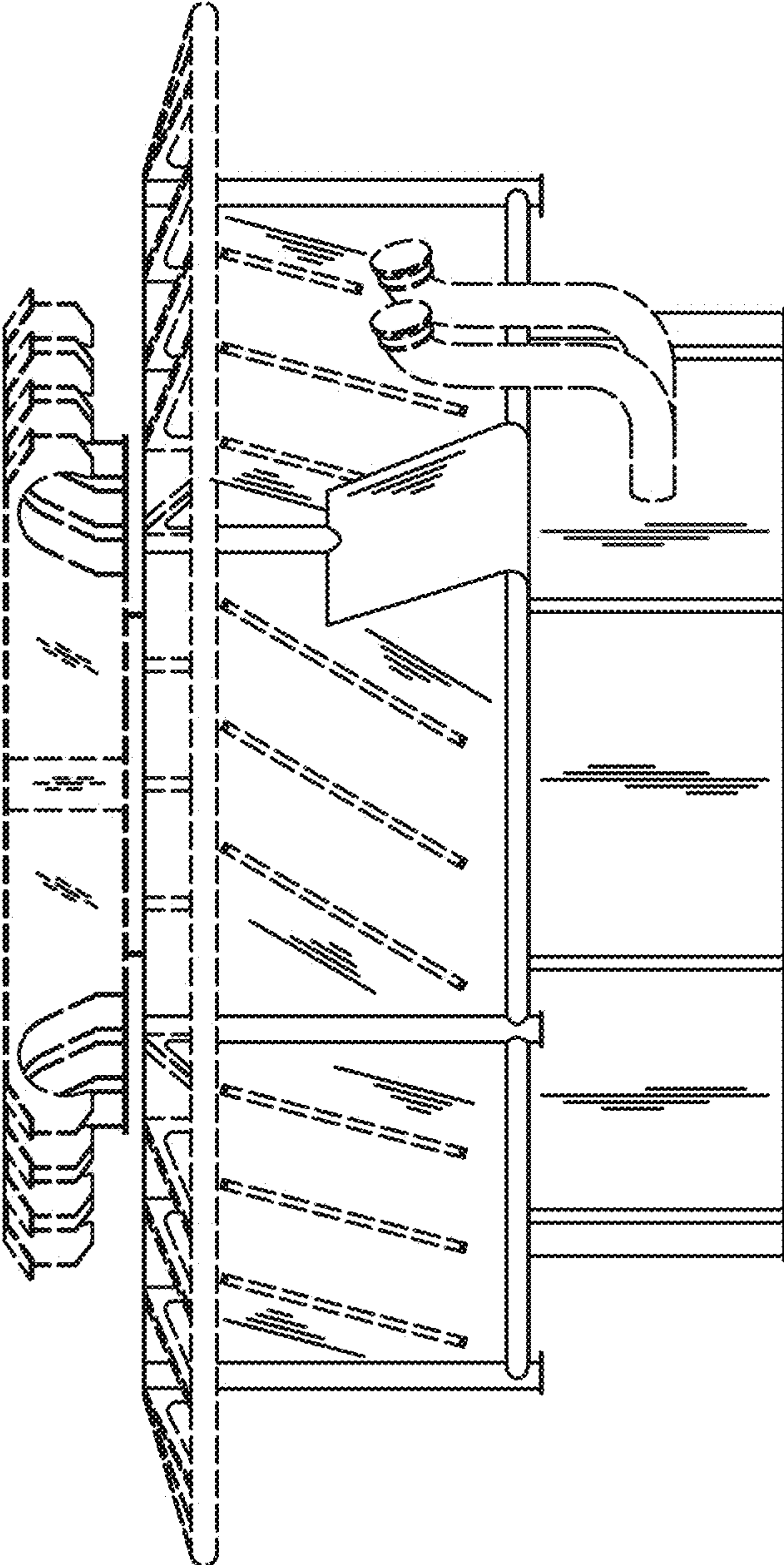

FIG. 4

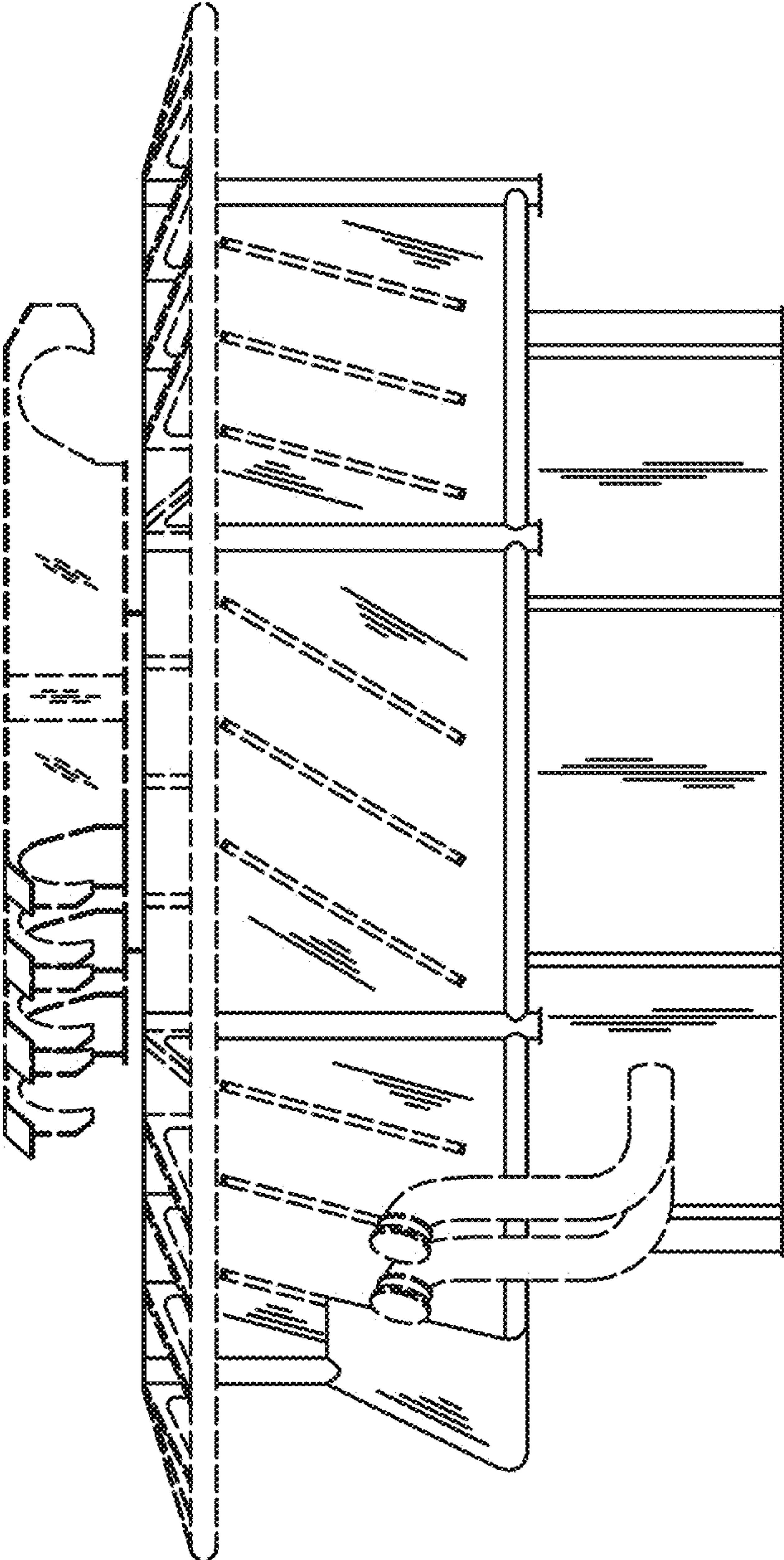

FIG. 5

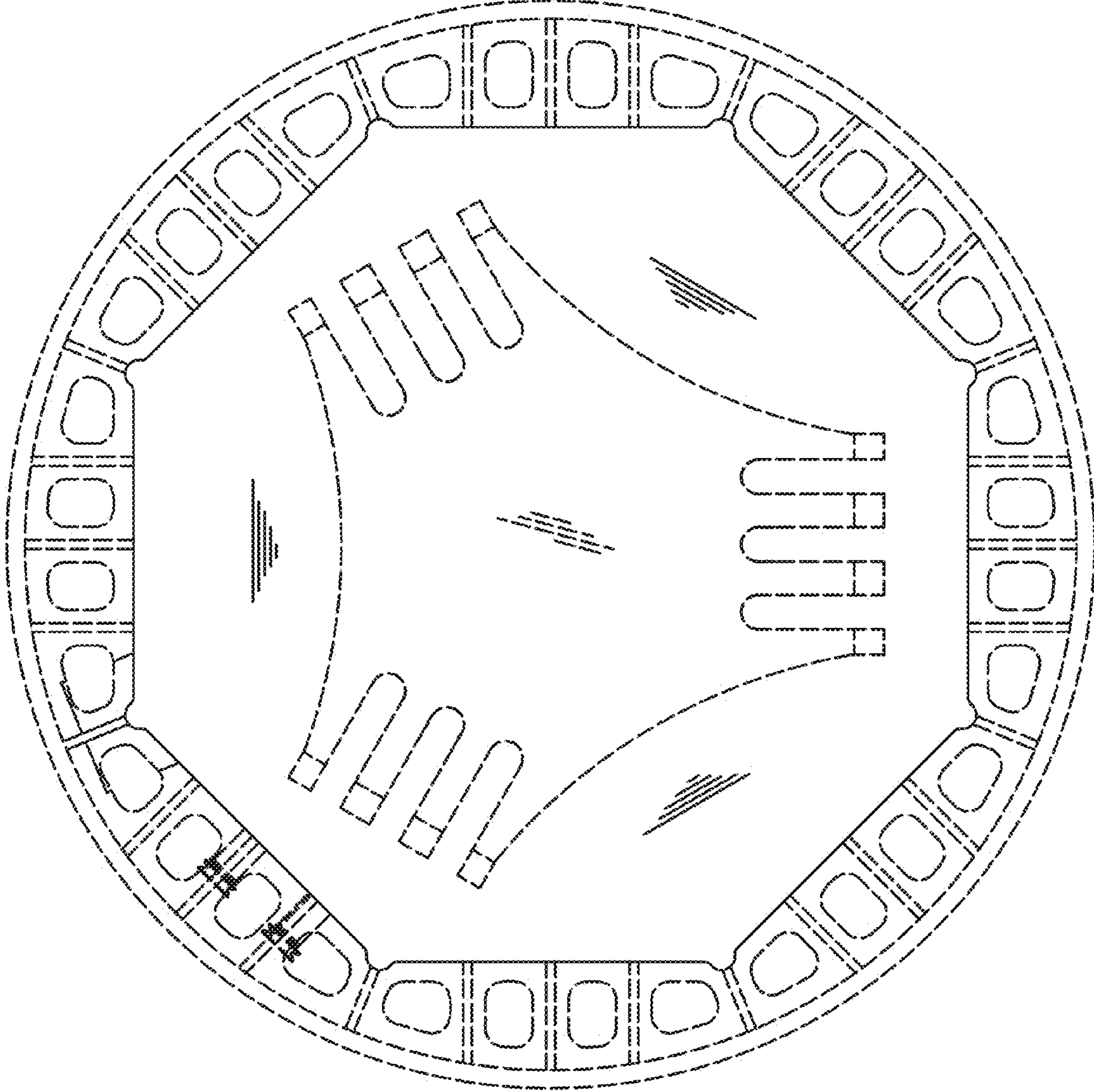

FIG. 6



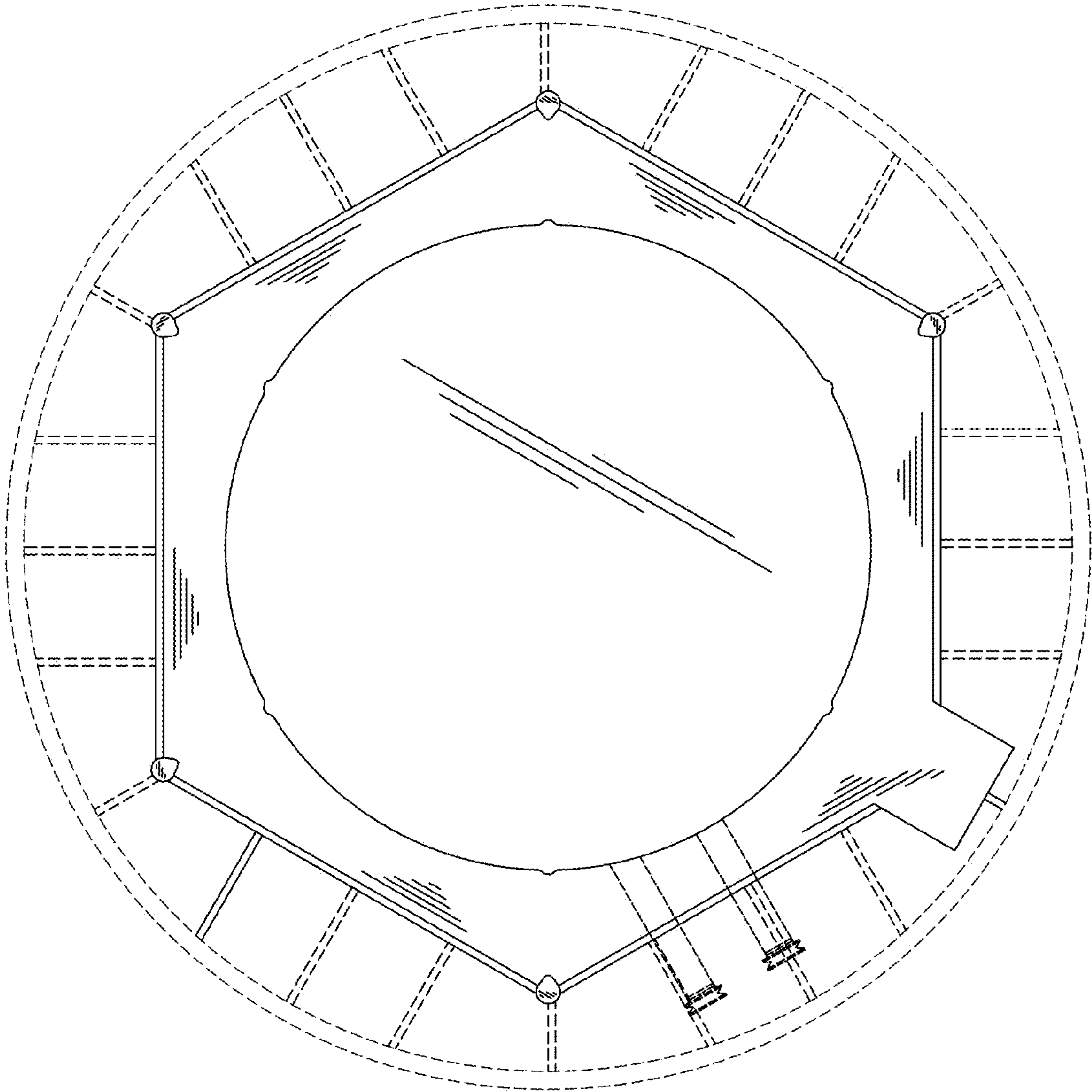

FIG. 7



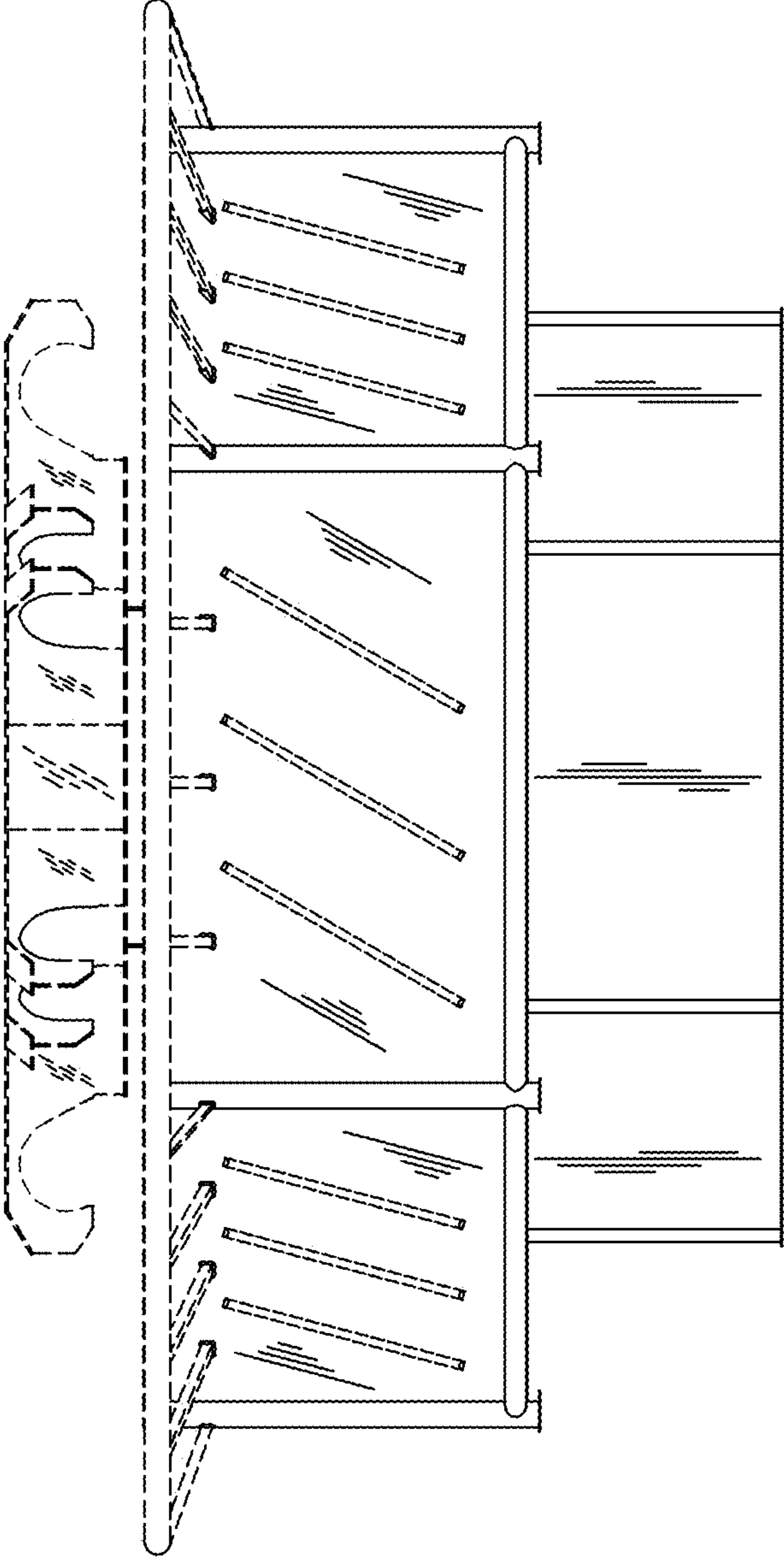

FIG. 8

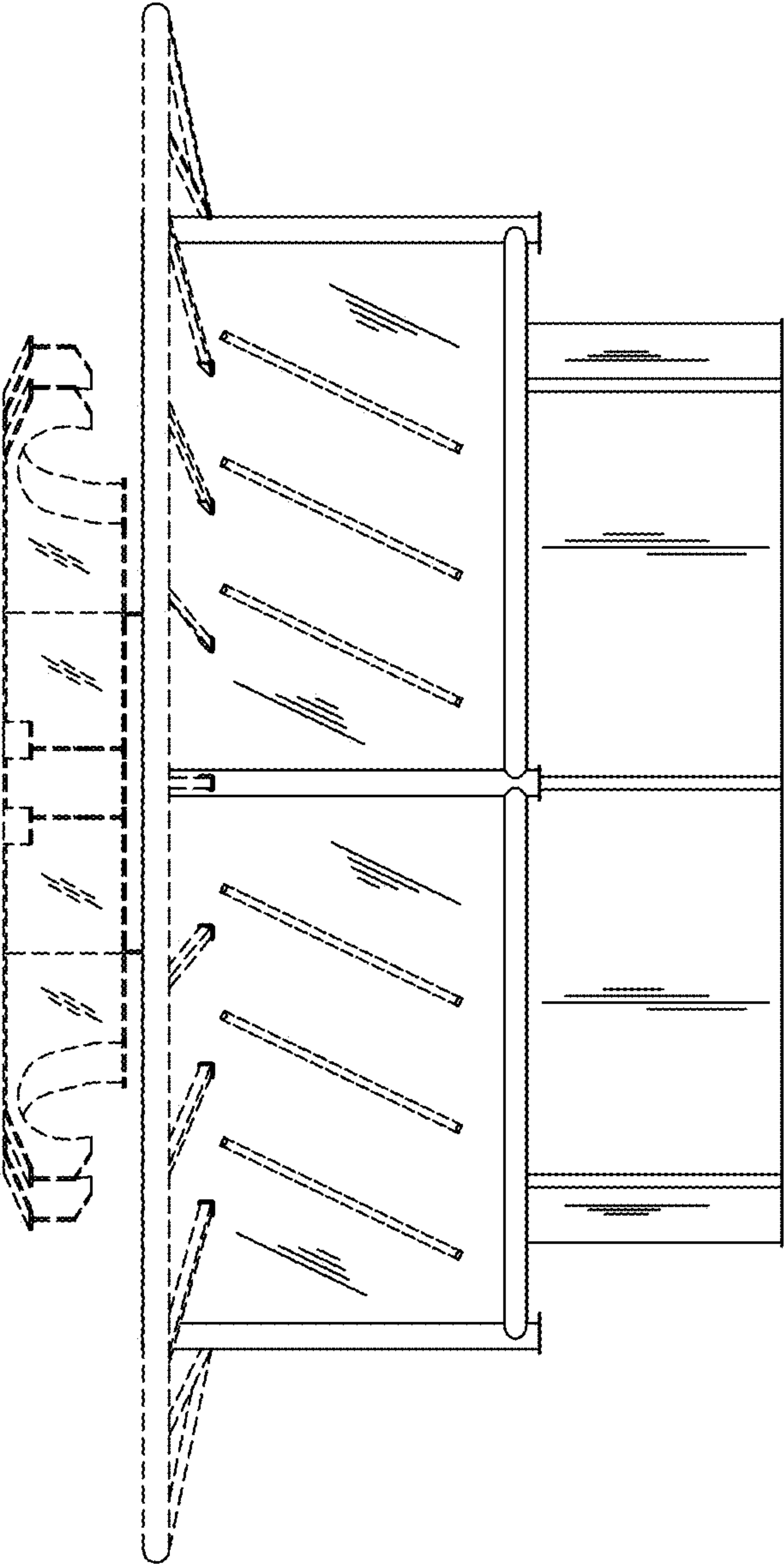

FIG. 9

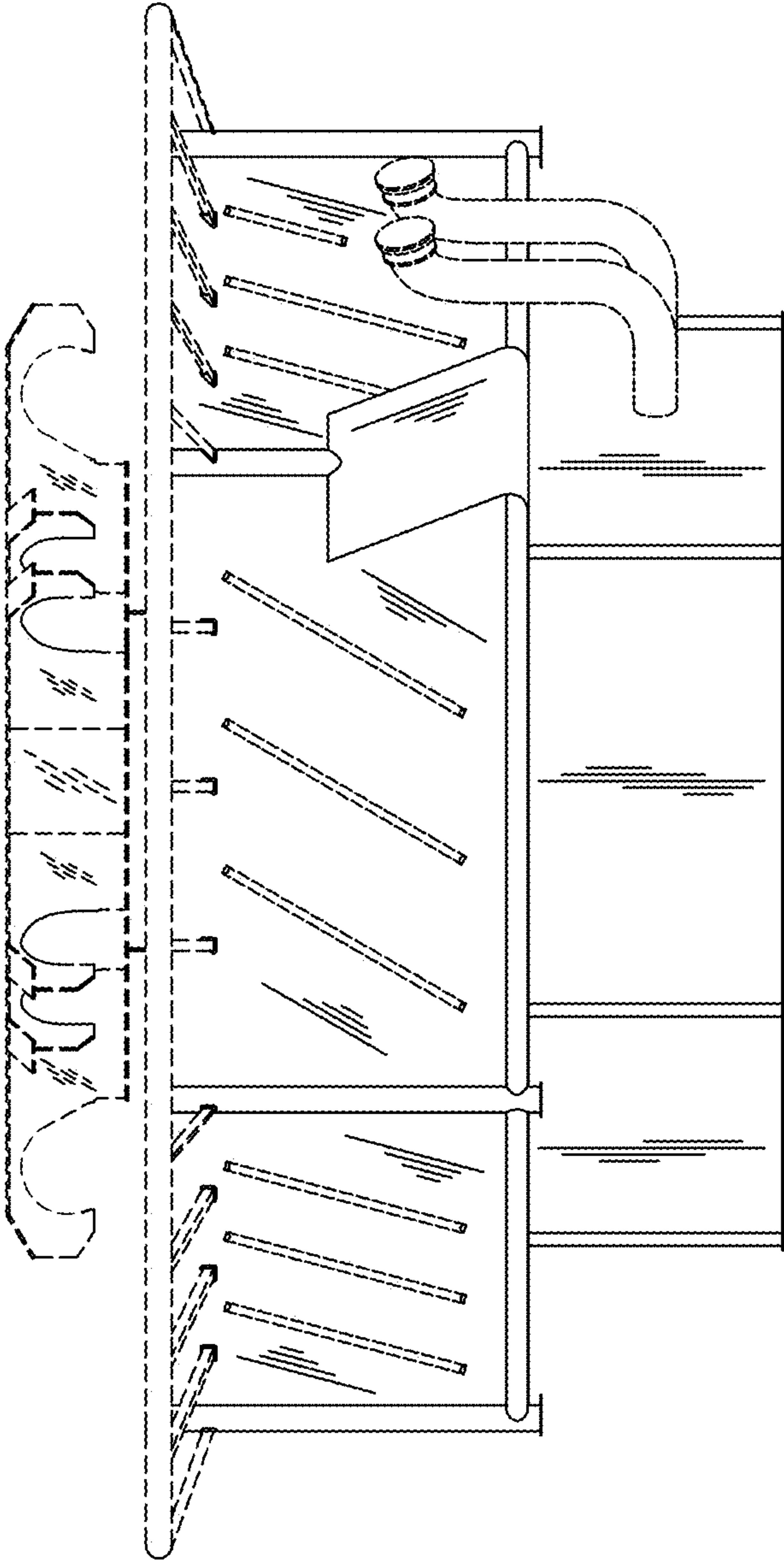

FIG. 10

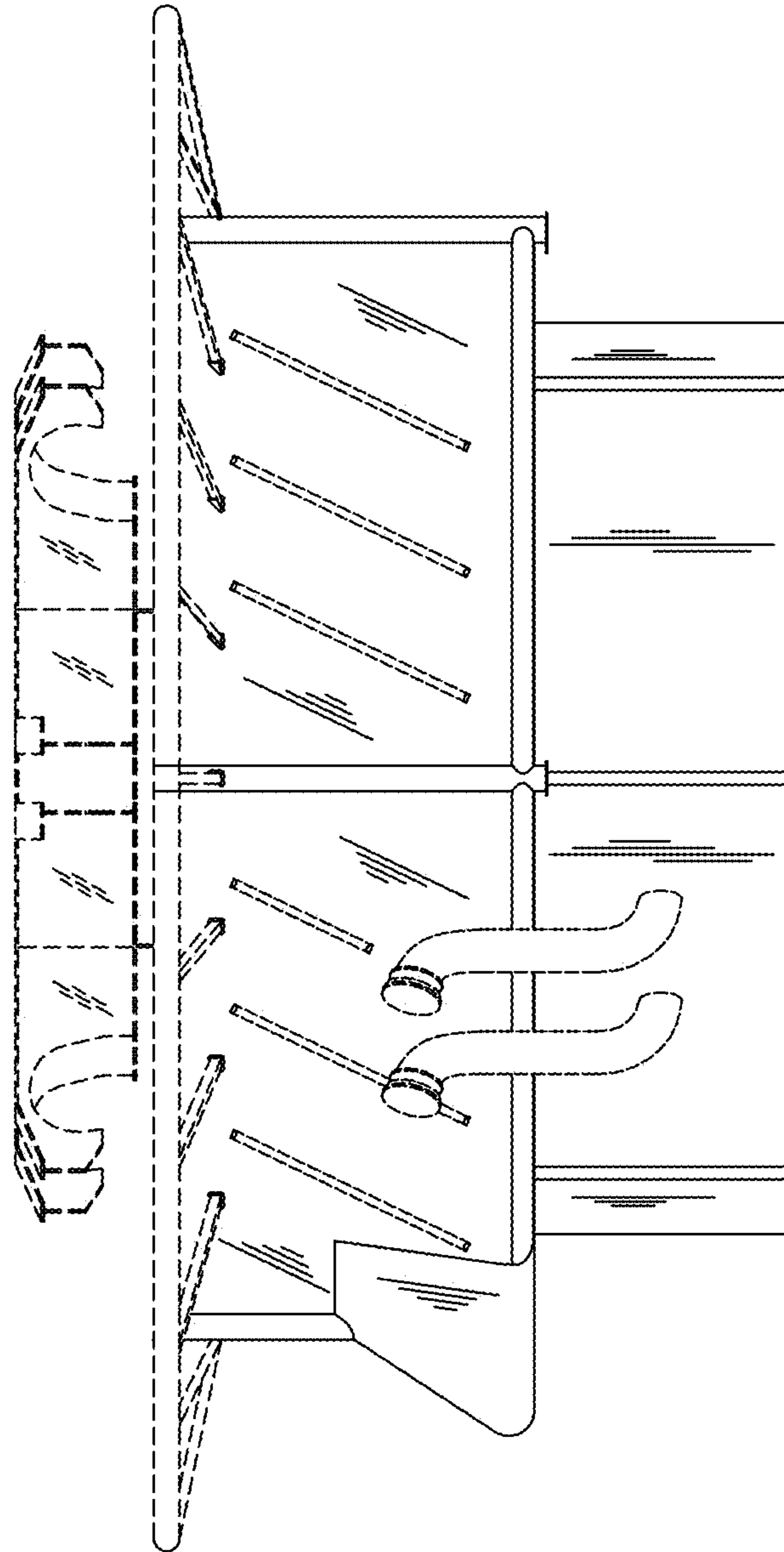

FIG. 11



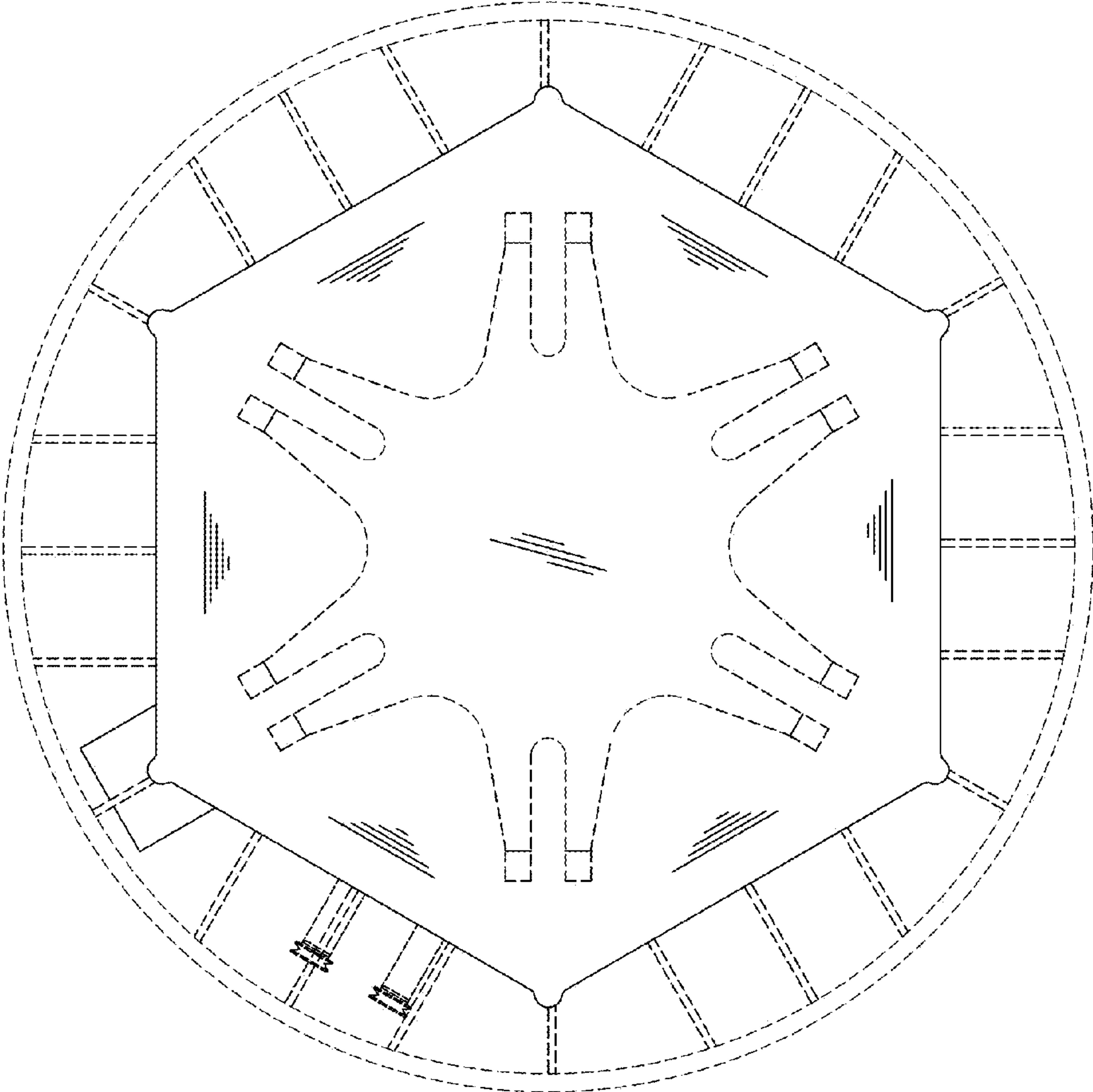

FIG. 12