



US00D700827S

(12) **United States Design Patent**
Starck

(10) **Patent No.:** **US D700,827 S**
(45) **Date of Patent:** **** Mar. 11, 2014**

(54) **HOOK**

(75) Inventor: **Philippe Starck**, Paris (FR)

(73) Assignee: **Hansgrohe SE**, Schiltach (DE)

(**) Term: **14 Years**

(21) Appl. No.: **29/431,617**

(22) Filed: **Sep. 10, 2012**

(30) **Foreign Application Priority Data**

Mar. 16, 2012 (EM) 001318273-0023

(51) **LOC (10) Cl.** **08-05**

(52) **U.S. Cl.**
USPC **D8/367**

(58) **Field of Classification Search**
USPC D8/367, 354, 349, 373; D6/323;
248/301-304, 339, 205.3

See application file for complete search history.

(56) **References Cited**

U.S. PATENT DOCUMENTS

D150,771	S	*	8/1948	Iskyan	D8/367
2,679,998	A	*	6/1954	Keller	248/205.3
2,765,998	A	*	10/1956	Engert	248/467
3,016,224	A	*	1/1962	Hall	248/205.3
3,637,181	A	*	1/1972	Janssen	248/205.3
D241,206	S	*	8/1976	Halsted	D6/323
D289,139	S	*	4/1987	Chasen	D8/367
D289,255	S	*	4/1987	Chasen	D8/367
D312,384	S	*	11/1990	Hamann	D8/367
D321,794	S	*	11/1991	Chap et al.	D6/323
D345,497	S	*	3/1994	Miller	D8/367
D346,950	S	*	5/1994	Dunn et al.	D8/367
D359,441	S	*	6/1995	Miller	D8/367
D364,045	S	*	11/1995	Starck	D8/367
D371,064	S	*	6/1996	Miller	D8/367
D374,602	S	*	10/1996	Protz, Jr.	D8/367

D393,412	S	*	4/1998	Bries et al.	D8/367
D397,256	S	*	8/1998	Moore et al.	D6/323
D417,606	S	*	12/1999	Bries et al.	D8/367
D448,654	S	*	10/2001	Snell	D8/367
D455,948	S	*	4/2002	Zetsche	D8/367
D458,535	S	*	6/2002	Henderson	D8/367
D460,306	S	*	7/2002	Lin	D6/524
D482,600	S	*	11/2003	Dretzka	D8/367
D490,694	S	*	6/2004	Levine-Umans	D8/367
D539,113	S	*	3/2007	Fulkerson	D8/367
D548,983	S	*	8/2007	Krumpe	D6/323
D554,482	S	*	11/2007	Hager et al.	D8/367
D566,532	S	*	4/2008	Wolff	D8/367
D567,517	S		4/2008	Massaud		
7,407,142	B1	*	8/2008	Lopez	248/304
D623,868	S	*	9/2010	Schiestl	D6/323
7,833,620	B2	*	11/2010	Enserink et al.	428/321.1

(Continued)

OTHER PUBLICATIONS

Brochure—VitrA® istanbul Collection by Ross Lovegrove 1-175, 4 pgs., VitrA Sanitaryware, Istanbul, Turkey, at least as early as Aug. 29, 2006.

Primary Examiner — Cynthia Underwood

(74) *Attorney, Agent, or Firm* — Lora J. Graentzdoerffer

(57) **CLAIM**

The ornamental design for a hook, as shown and described.

DESCRIPTION

FIG. 1 is a perspective view of a hook showing my design; FIG. 2 is a front elevational view thereof; FIG. 3 is a rear elevational view thereof; FIG. 4 is a left side elevational view thereof; FIG. 5 is a right side elevational view thereof; FIG. 6 is a top plan view thereof; and, FIG. 7 is a bottom plan view thereof. The broken lines are for the purposes of illustrating environment and form no part of the claimed design.

1 Claim, 7 Drawing Sheets

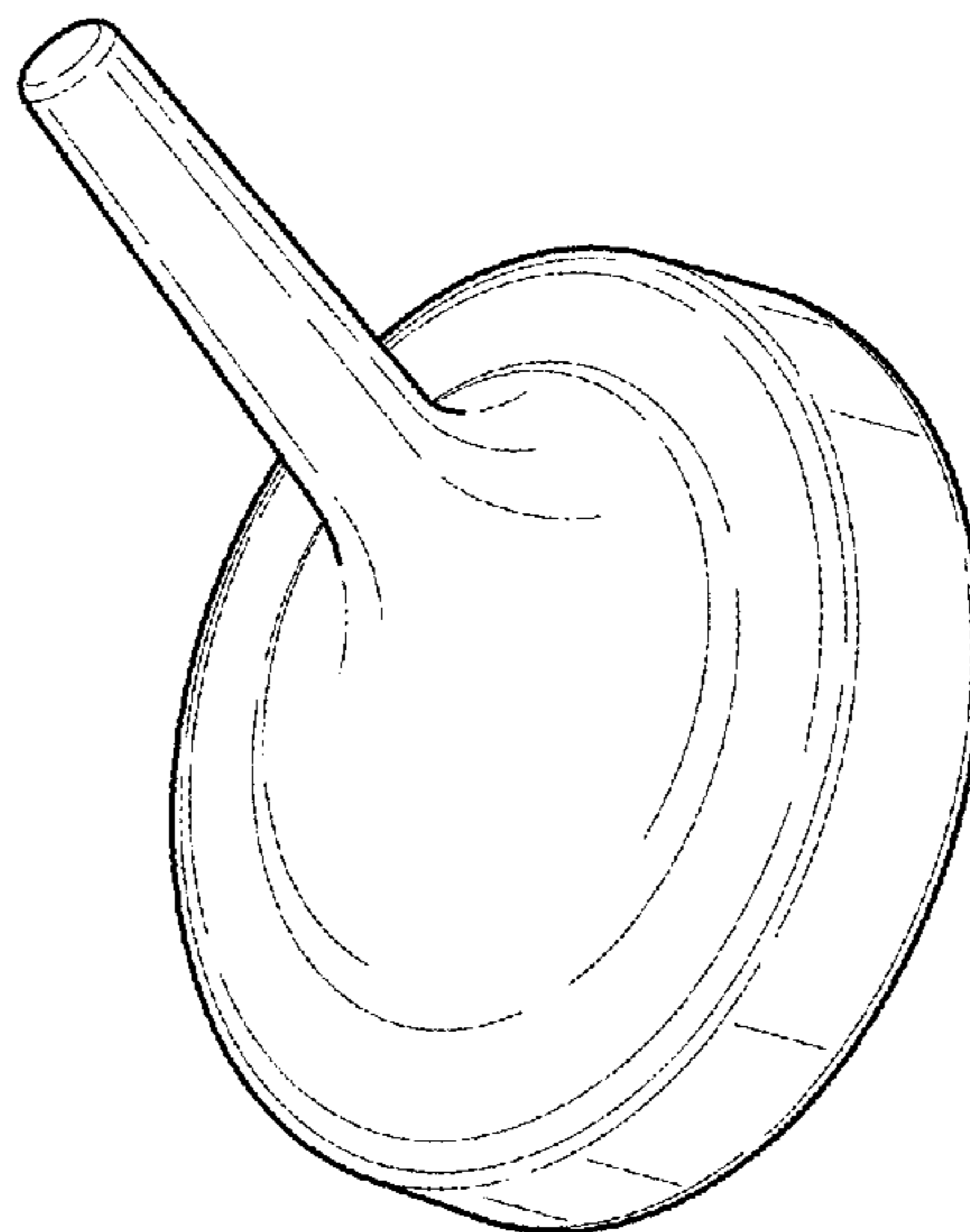

(56)

References Cited

U.S. PATENT DOCUMENTS

D630,446 S * 1/2011 Dammers D6/328
D632,951 S * 2/2011 McGreevy et al. D8/367
D641,228 S * 7/2011 Qiblawi et al. D8/367

D644,502 S * 9/2011 Portz D8/372
D658,029 S * 4/2012 Fulkerson et al. D8/307
8,376,297 B2 * 2/2013 Portz 248/215
D682,663 S * 5/2013 Evon D8/367

* cited by examiner

FIG. 1

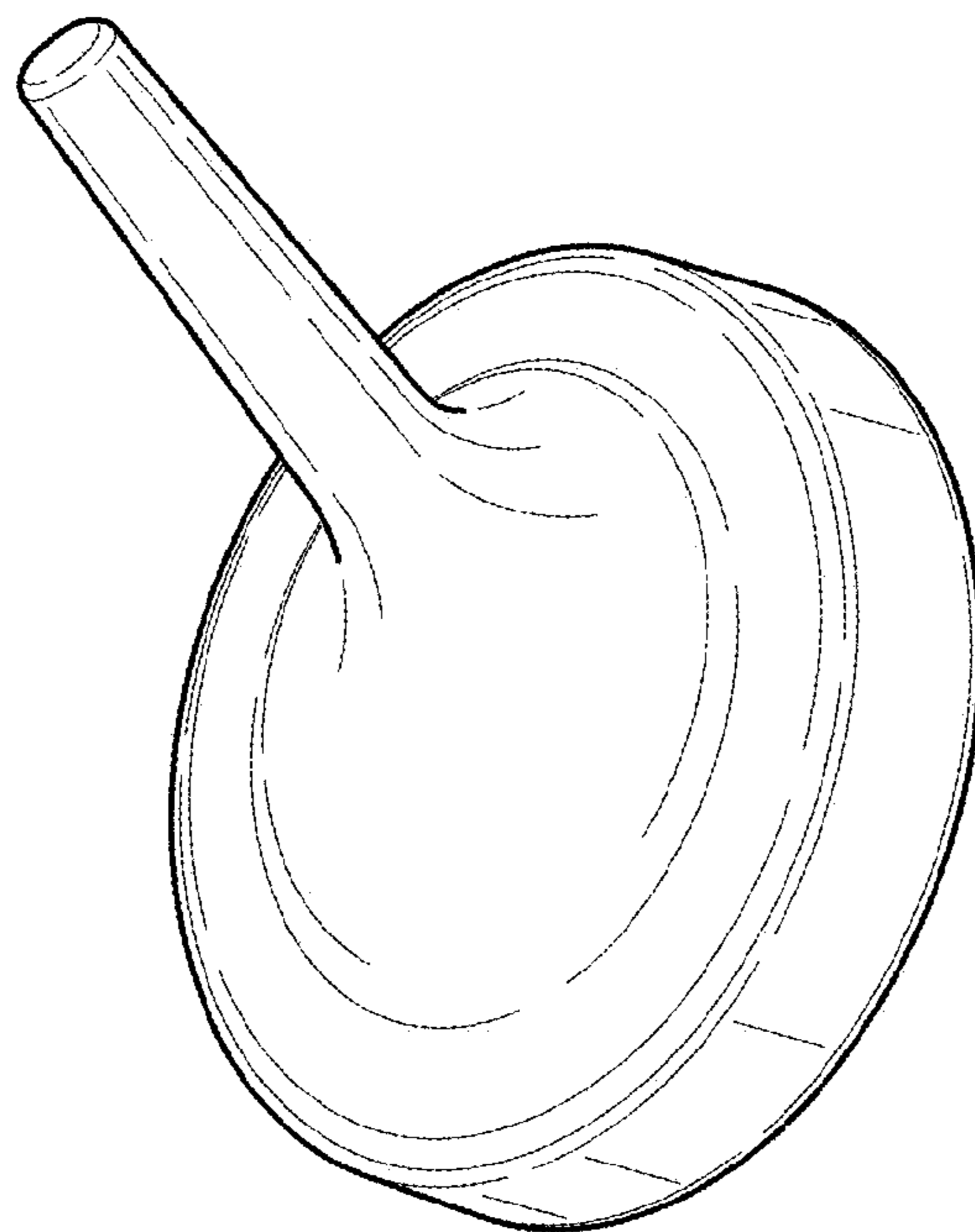

FIG. 2

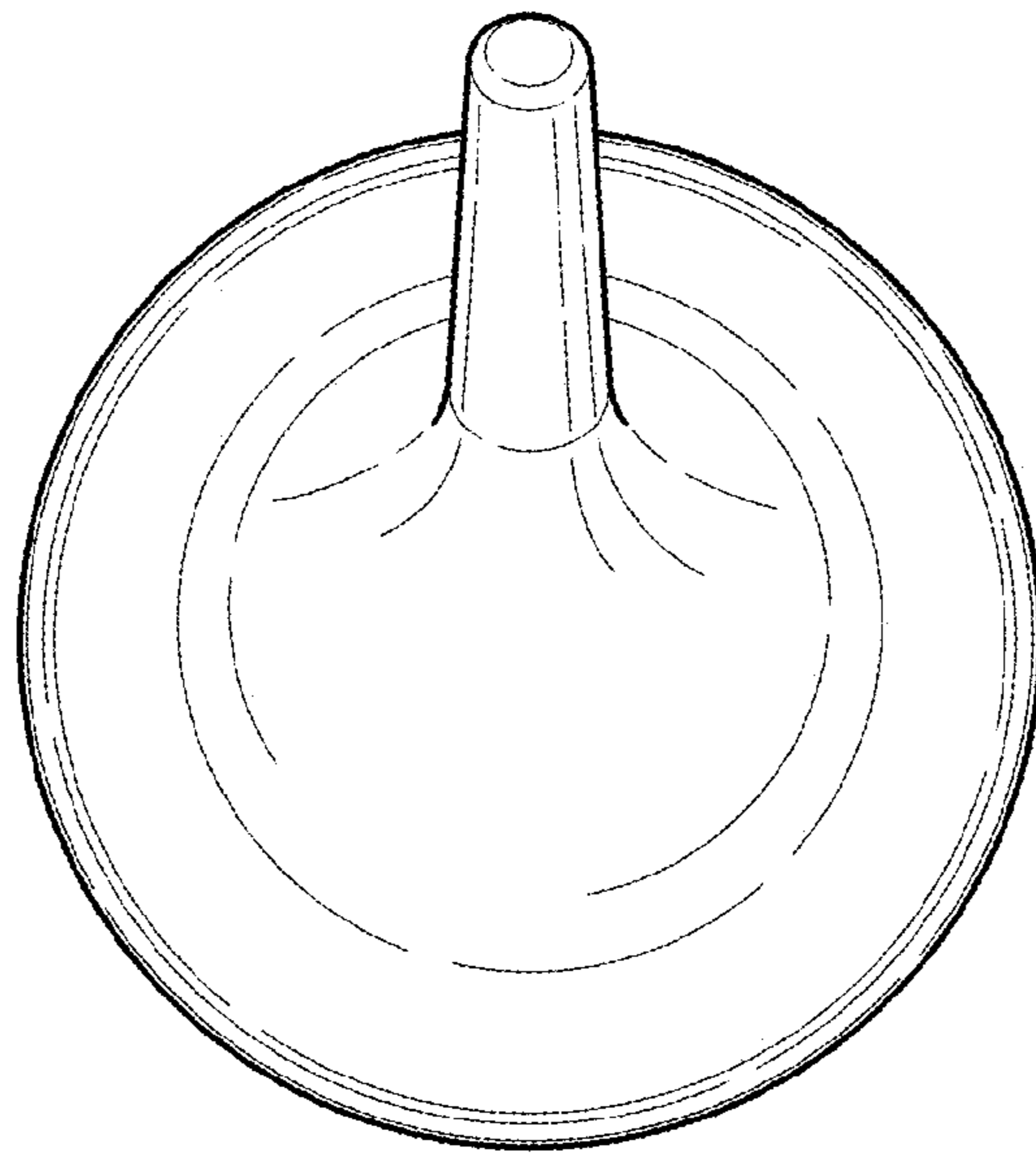

FIG. 3

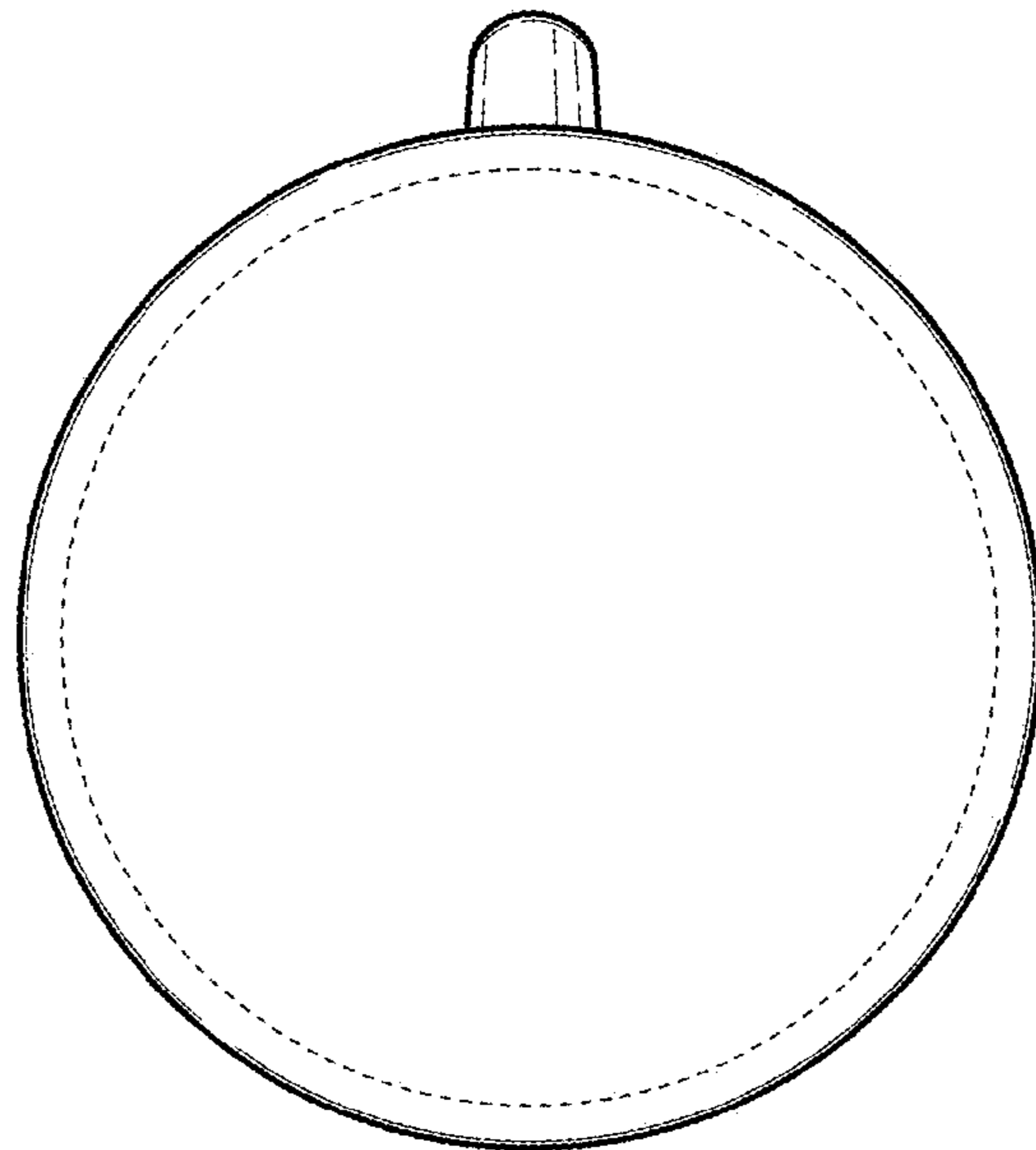

FIG. 4

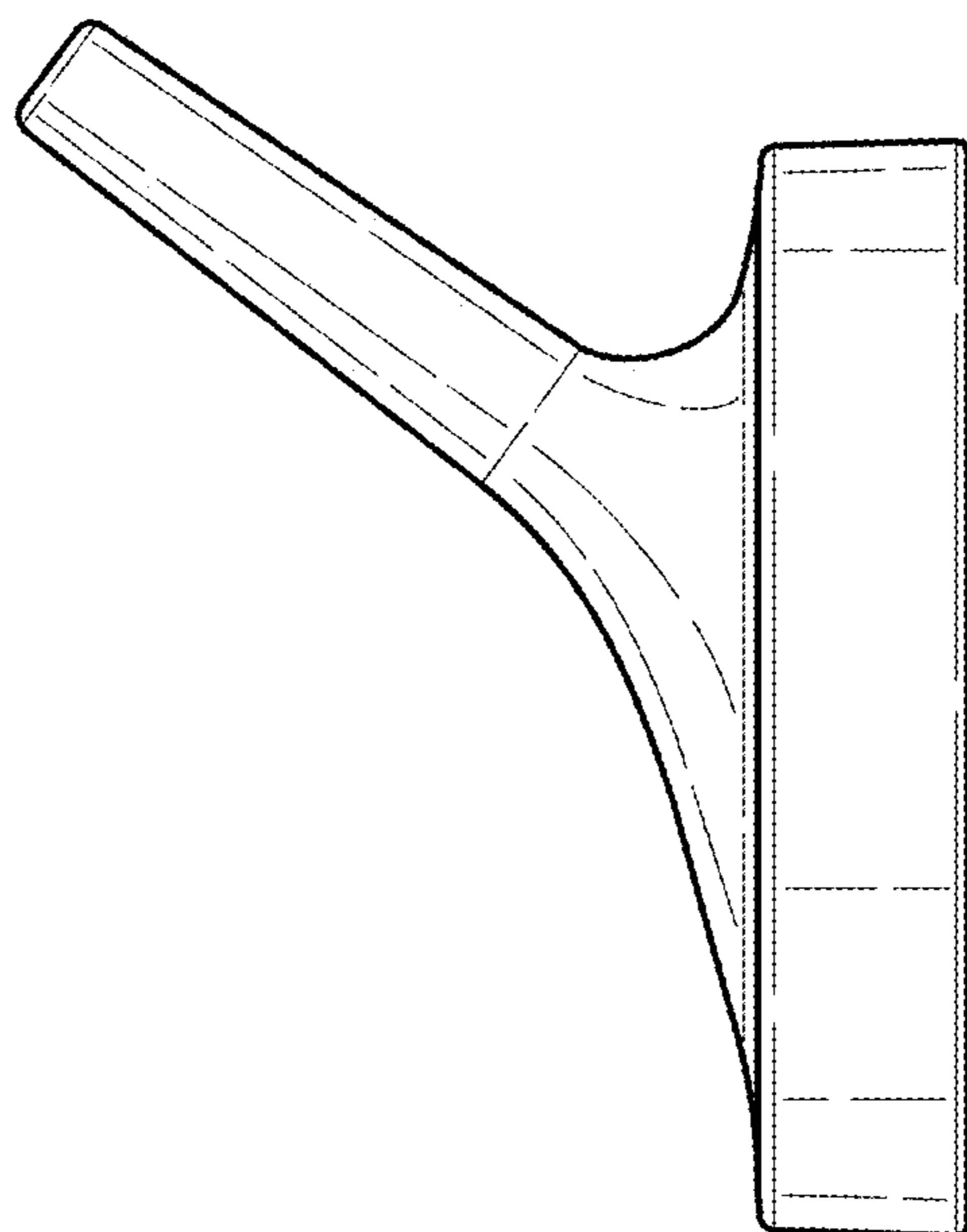

FIG. 5

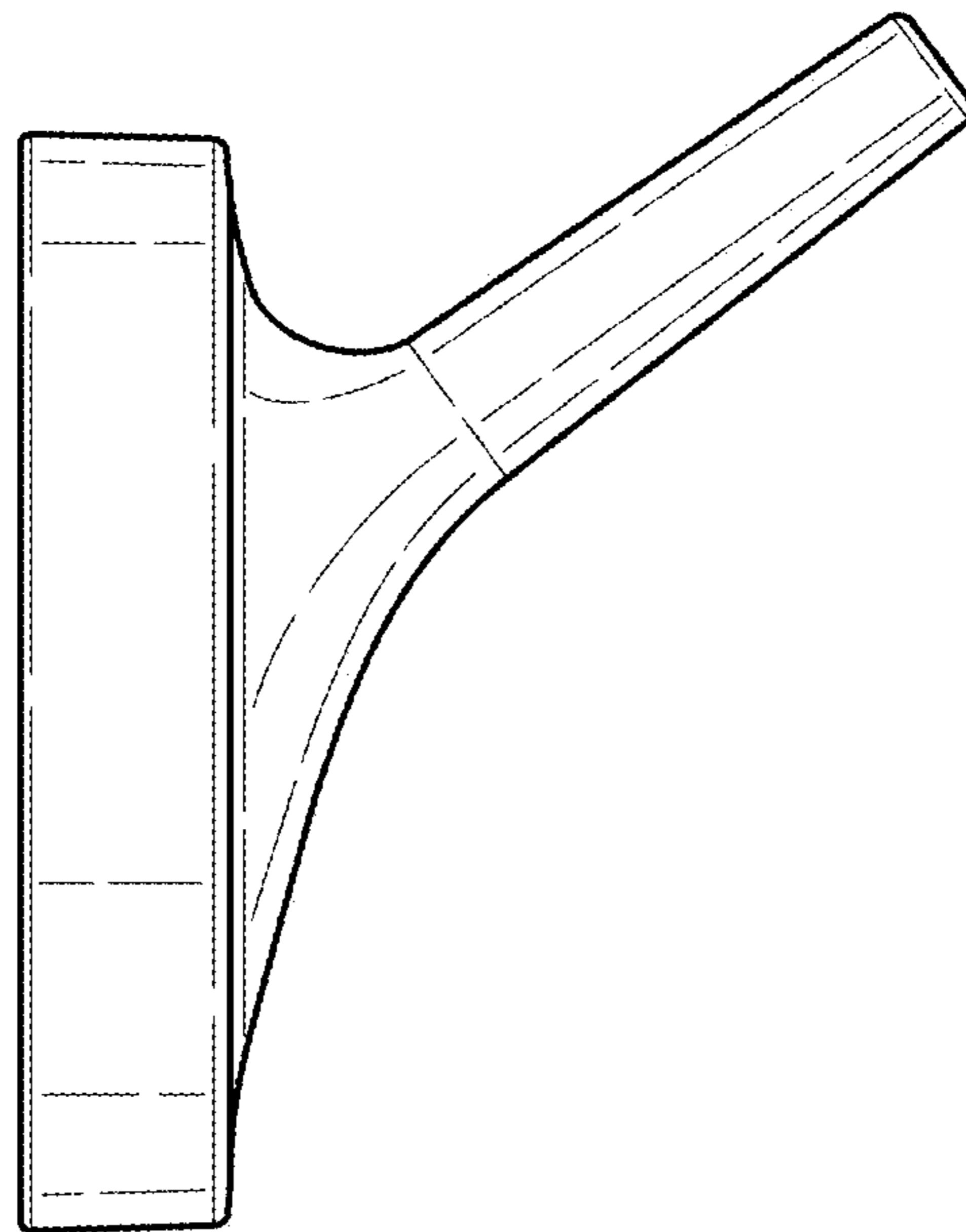

FIG. 6

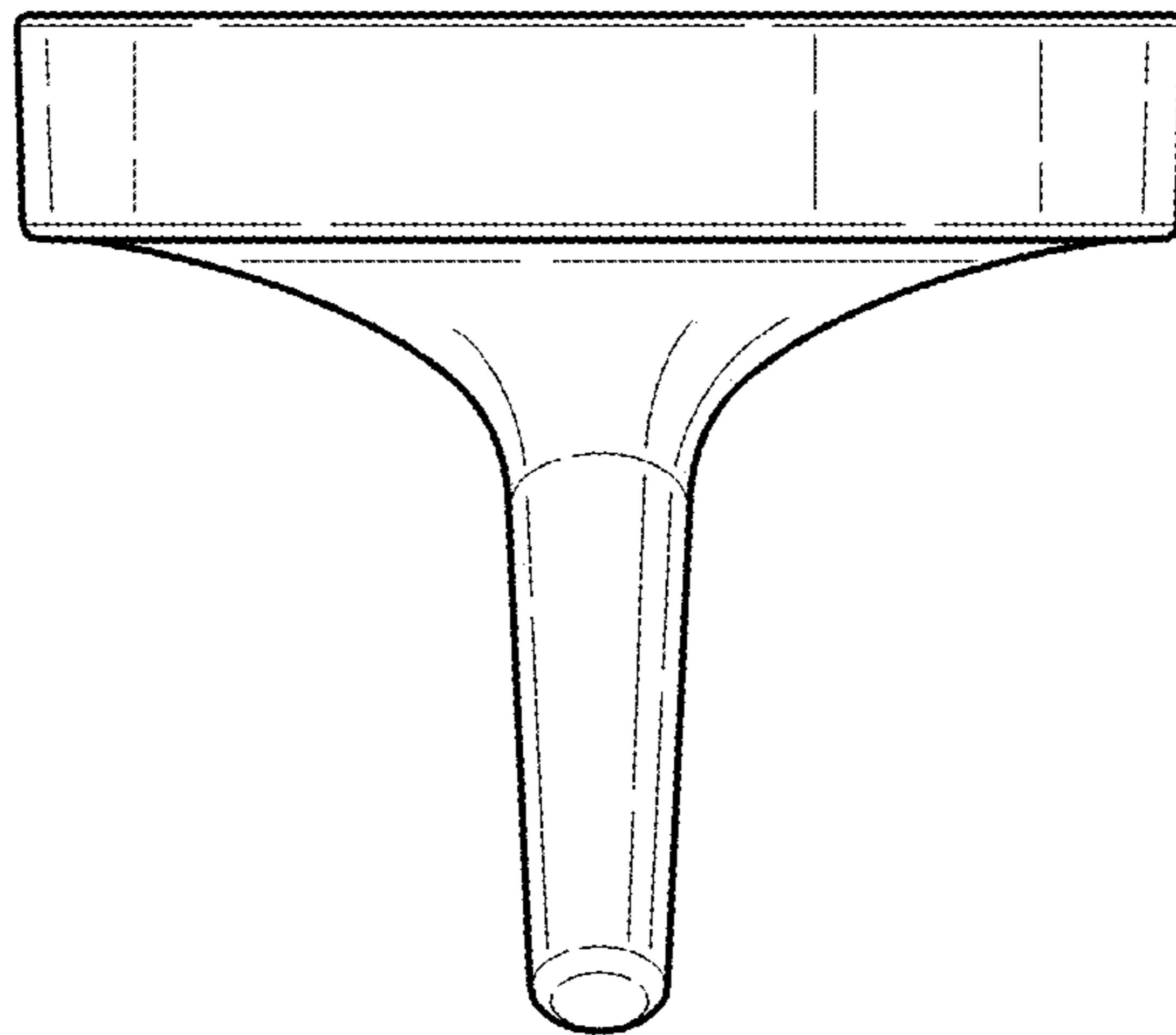

FIG. 7

