



US00D700806S

(12) **United States Design Patent**  
**Joy**

(10) **Patent No.:** **US D700,806 S**  
(45) **Date of Patent:** **\*\* Mar. 11, 2014**

- (54) **BEVERAGE GLASS**
- (71) Applicant: **LifeFactory, Inc.**, Sausalito, CA (US)
- (72) Inventor: **Daren Joy**, Sausalito, CA (US)
- (73) Assignee: **Lifefactory, Inc.**, Sausalito, CA (US)
- (\*\*) Term: **14 Years**
- (21) Appl. No.: **29/454,467**
- (22) Filed: **May 10, 2013**
- (51) **LOC (10) Cl.** ..... **07-01**
- (52) **U.S. Cl.**  
USPC ..... **D7/507; D7/523; D7/509; D7/624.2**
- (58) **Field of Classification Search**  
CPC ..... **A47G 19/22; A47G 19/23; A45F 3/16**  
USPC ..... **D7/523, 507, 514, 624.2, 607, 608;**  
**215/11.1, 11.6; 206/459.5; 220/739**  
See application file for complete search history.

D621,259	S	*	8/2010	Joy et al.	.....	D9/444
D623,899	S	*	9/2010	Baratte	.....	D7/531
D629,259	S	*	12/2010	Joy et al.	.....	D7/624.2
D634,159	S	*	3/2011	Bodum	.....	D7/509
D644,072	S	*	8/2011	McDonald et al.	.....	D7/667
8,579,133	B2	*	11/2013	Marcus et al.	.....	215/11.6
D696,080	S	*	12/2013	Joy	.....	D7/629
8,608,018	B2	*	12/2013	Babinsky et al.	.....	220/739
2009/0057257	A1	*	3/2009	Marcus et al.	.....	215/11.6

\* cited by examiner

*Primary Examiner* — Marianne Pandozzi

(74) *Attorney, Agent, or Firm* — The Mueller Law Office, P.C.

(57) **CLAIM**

The ornamental design for a beverage glass, as shown and described.

**DESCRIPTION**

- FIG. 1 shows a perspective view of a design for a beverage glass.
- FIG. 2 shows a front view of the design.
- FIG. 3 shows a back view of the design.
- FIG. 4 shows a left side view of the design.
- FIG. 5 shows a right side view of the design.
- FIG. 6 shows a top view of the design.
- FIG. 7 shows a bottom view of the design.
- FIG. 8 shows an oblique perspective view of the design; and,
- FIG. 9 shows another oblique perspective of the design.

**1 Claim, 9 Drawing Sheets**

(56) **References Cited**  
U.S. PATENT DOCUMENTS

D78,014	S	*	3/1929	Dunbar	.....	D7/523
D206,889	S	*	2/1967	Benes	.....	D7/523
D216,096	S	*	11/1969	Lawton	.....	D9/501
D267,332	S	*	12/1982	Pirovano et al.	.....	D19/85
D492,547	S	*	7/2004	Hsu	.....	D7/523
D567,094	S	*	4/2008	Bickert	.....	D9/529
D612,687	S	*	3/2010	Gilbert et al.	.....	D7/509
D615,816	S	*	5/2010	Joy et al.	.....	D7/507

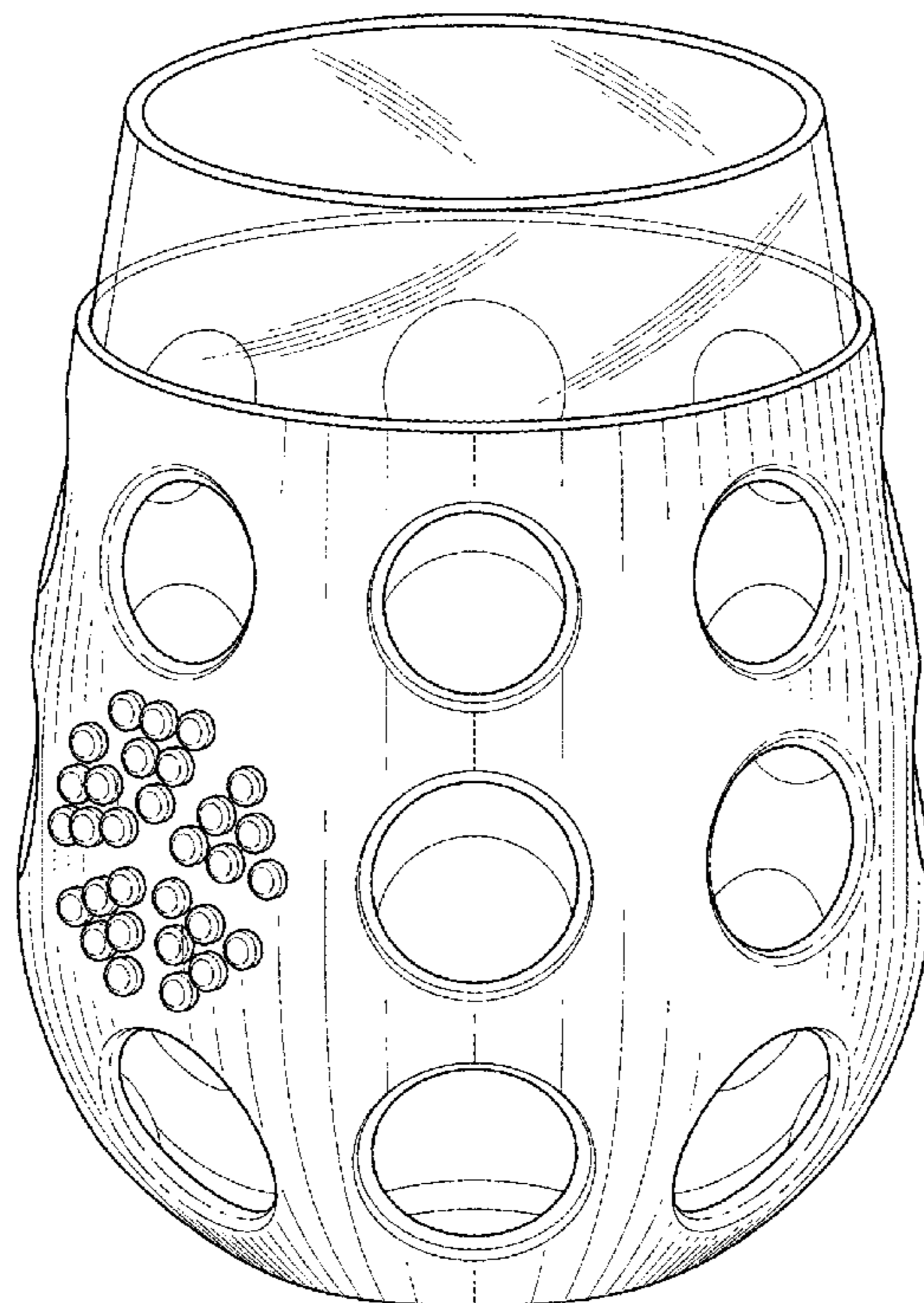

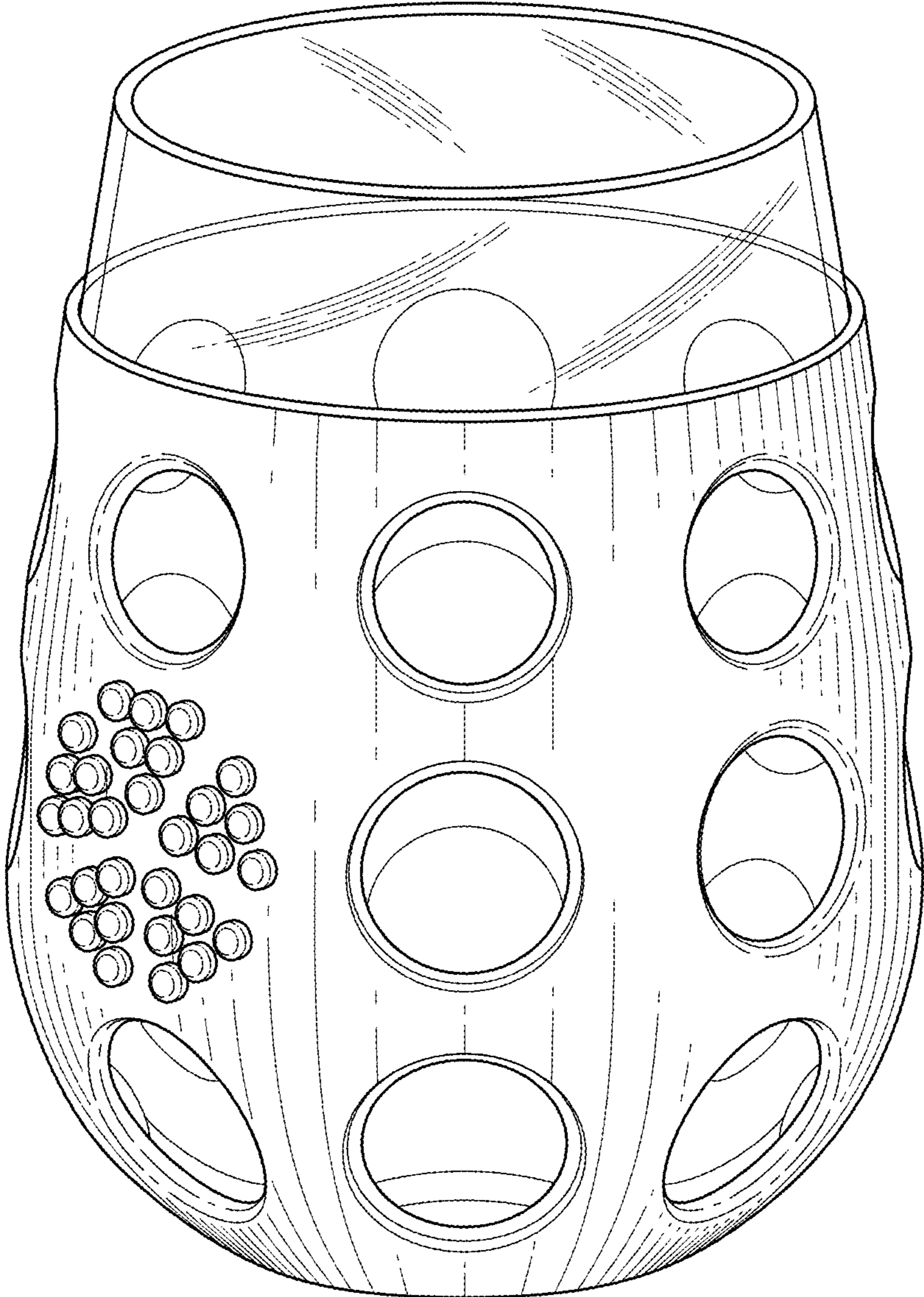

FIG. 1

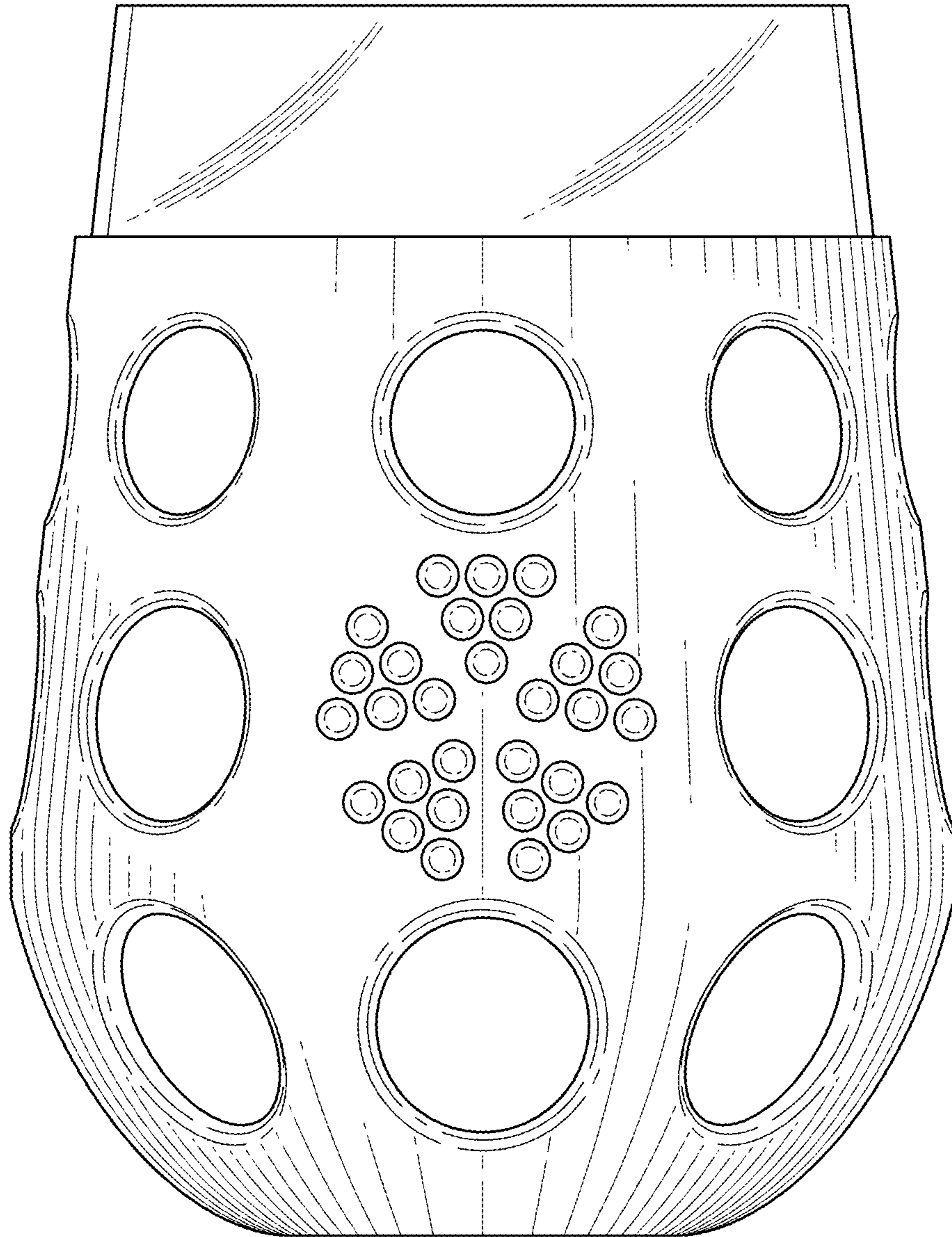

FIG. 2

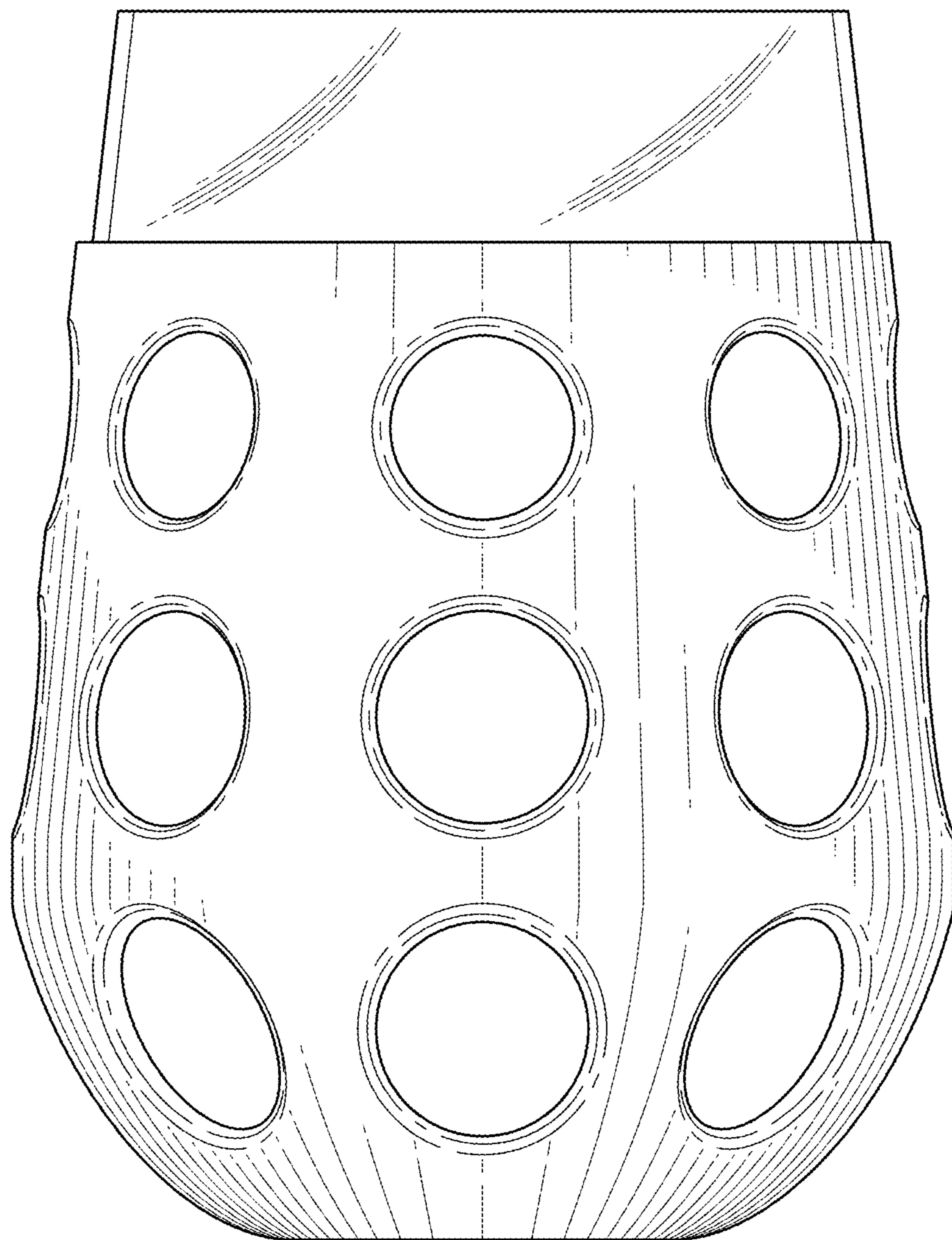

FIG. 3

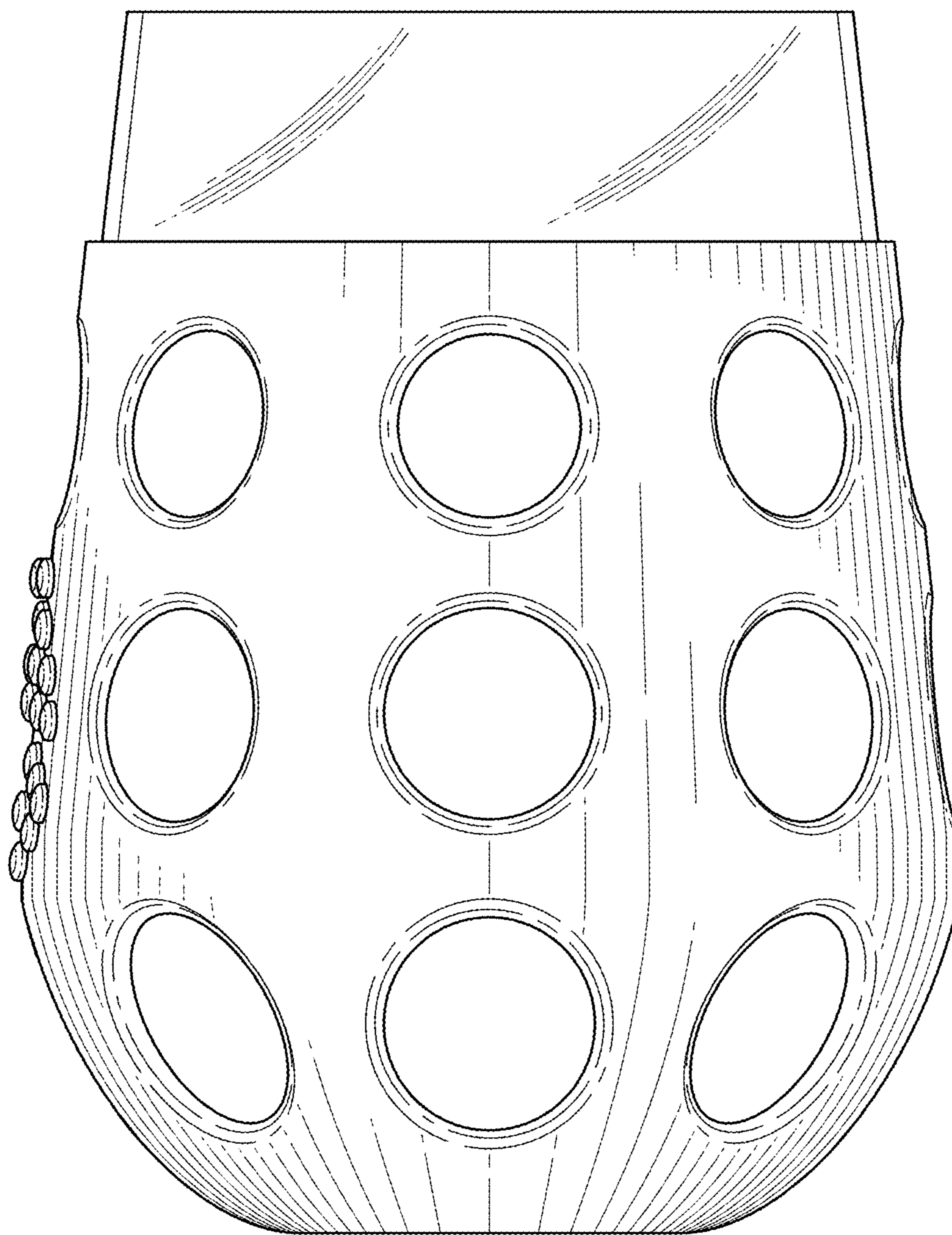

FIG. 4

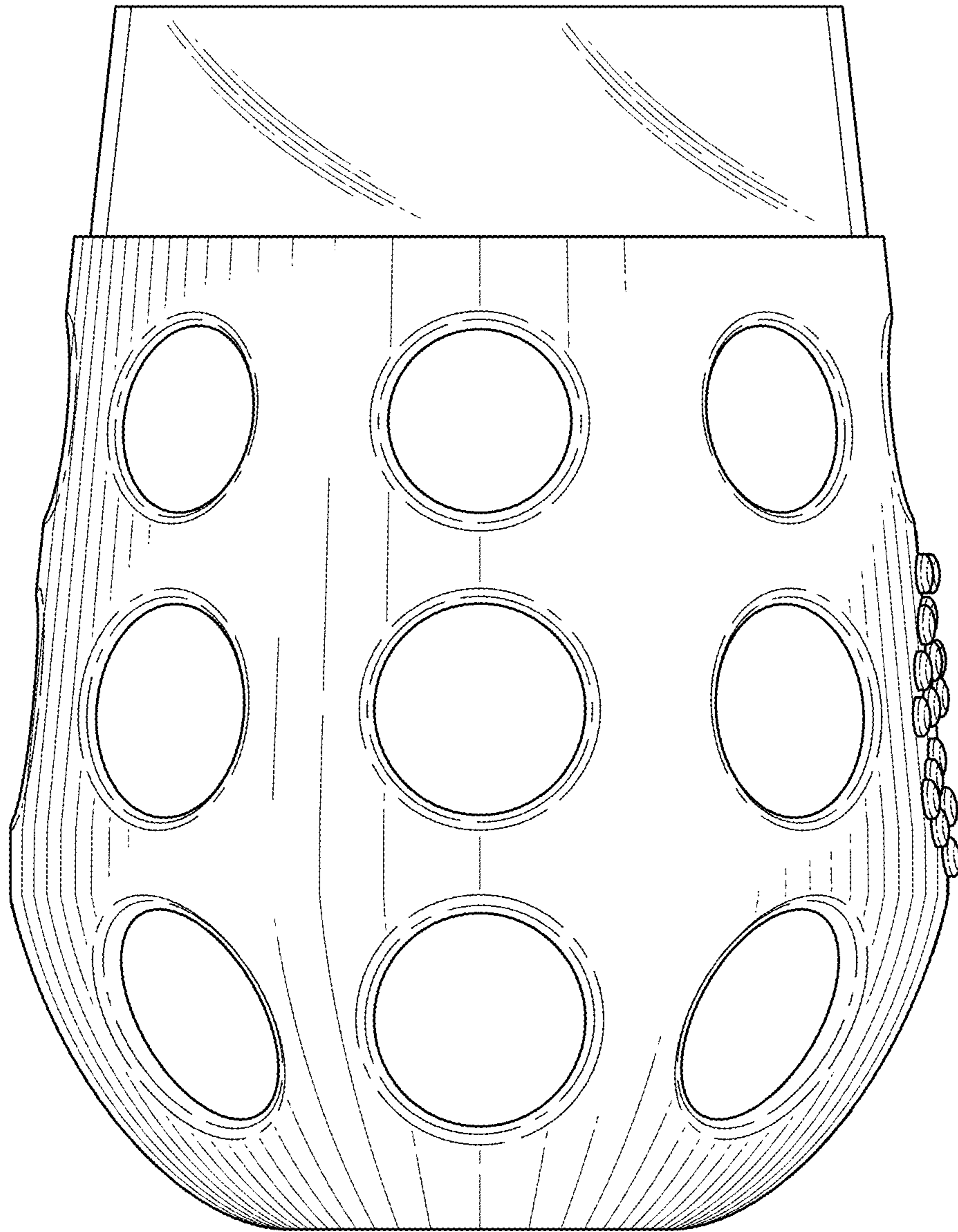

FIG. 5

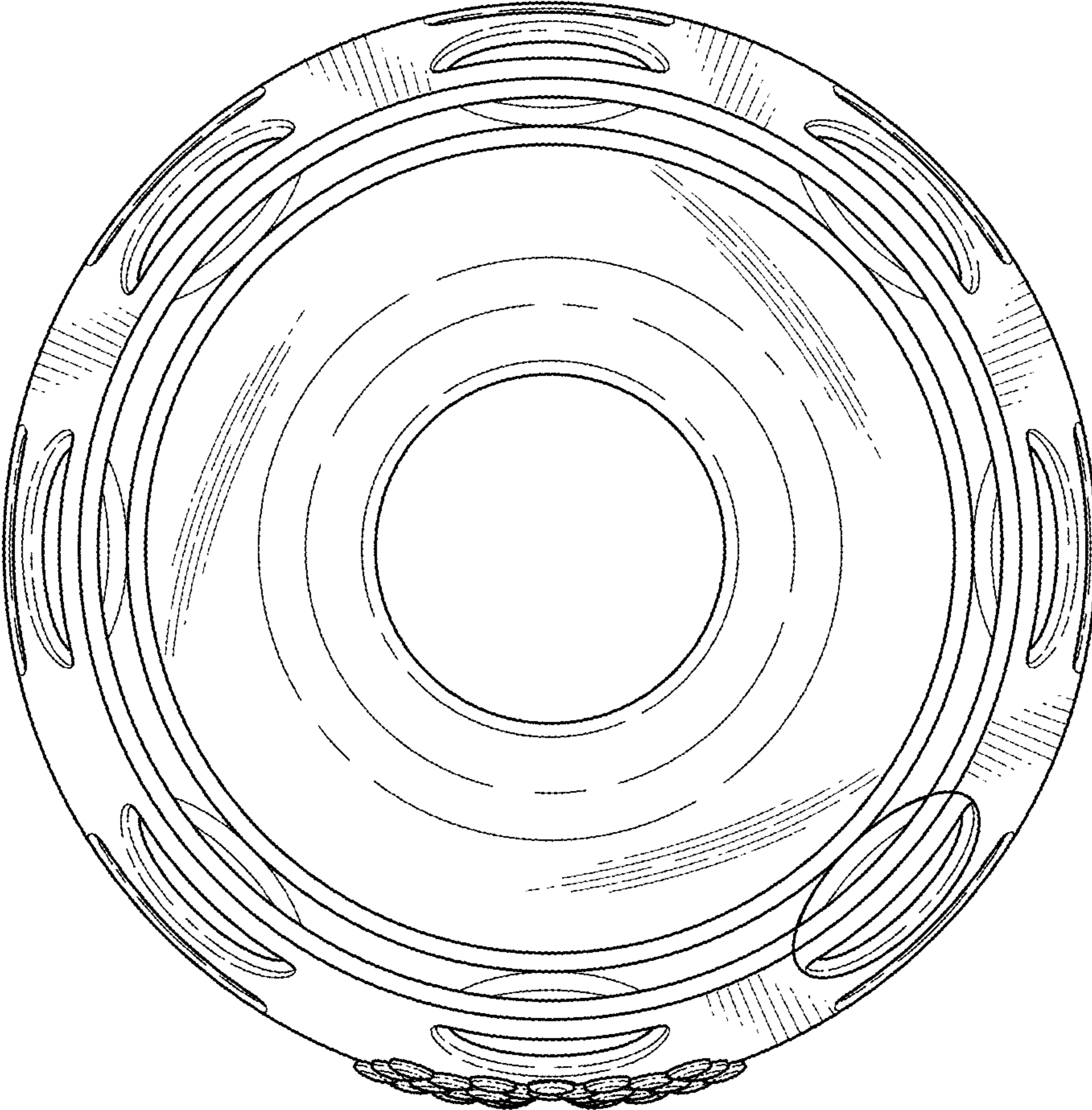

FIG. 6

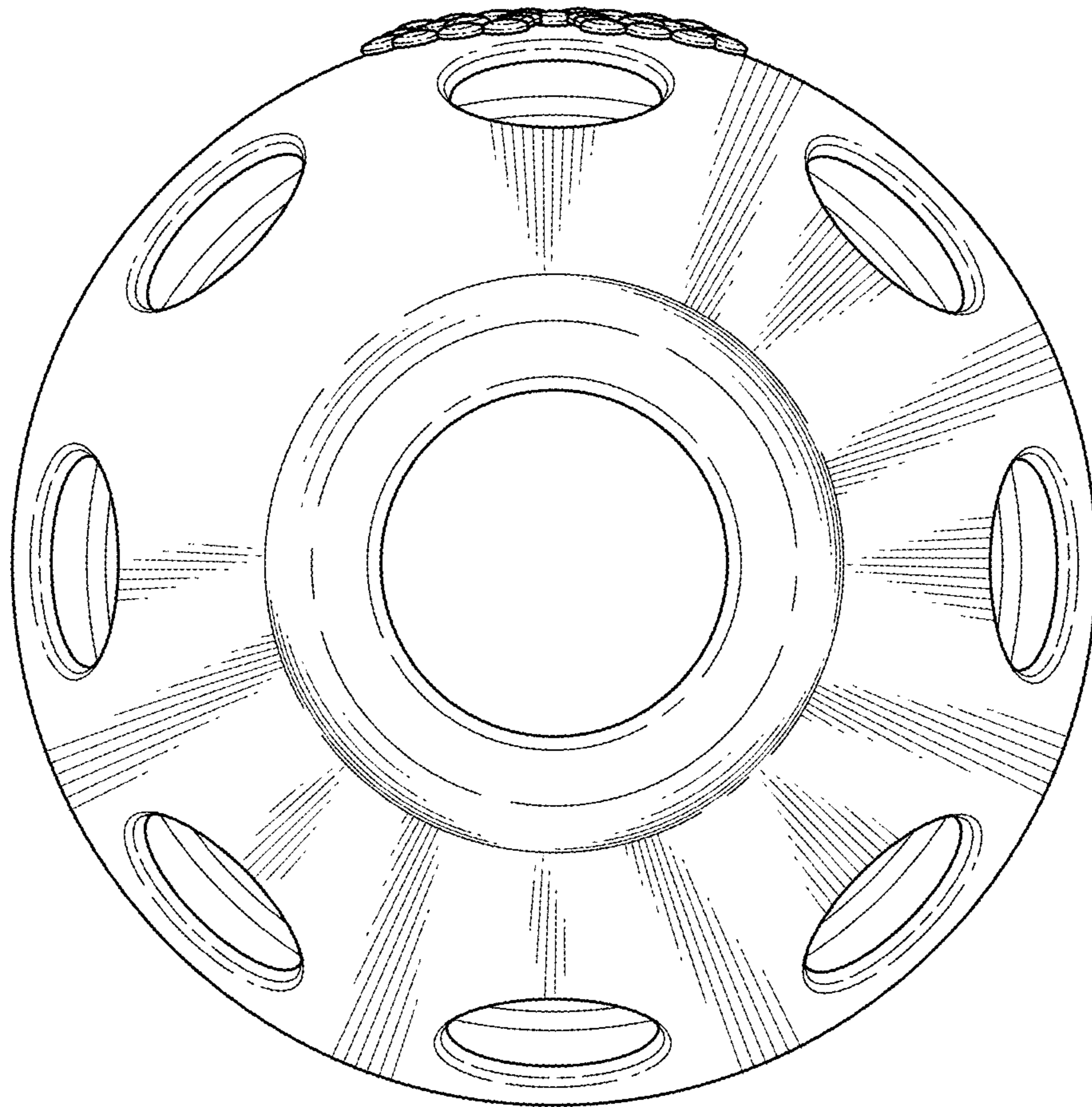

FIG. 7



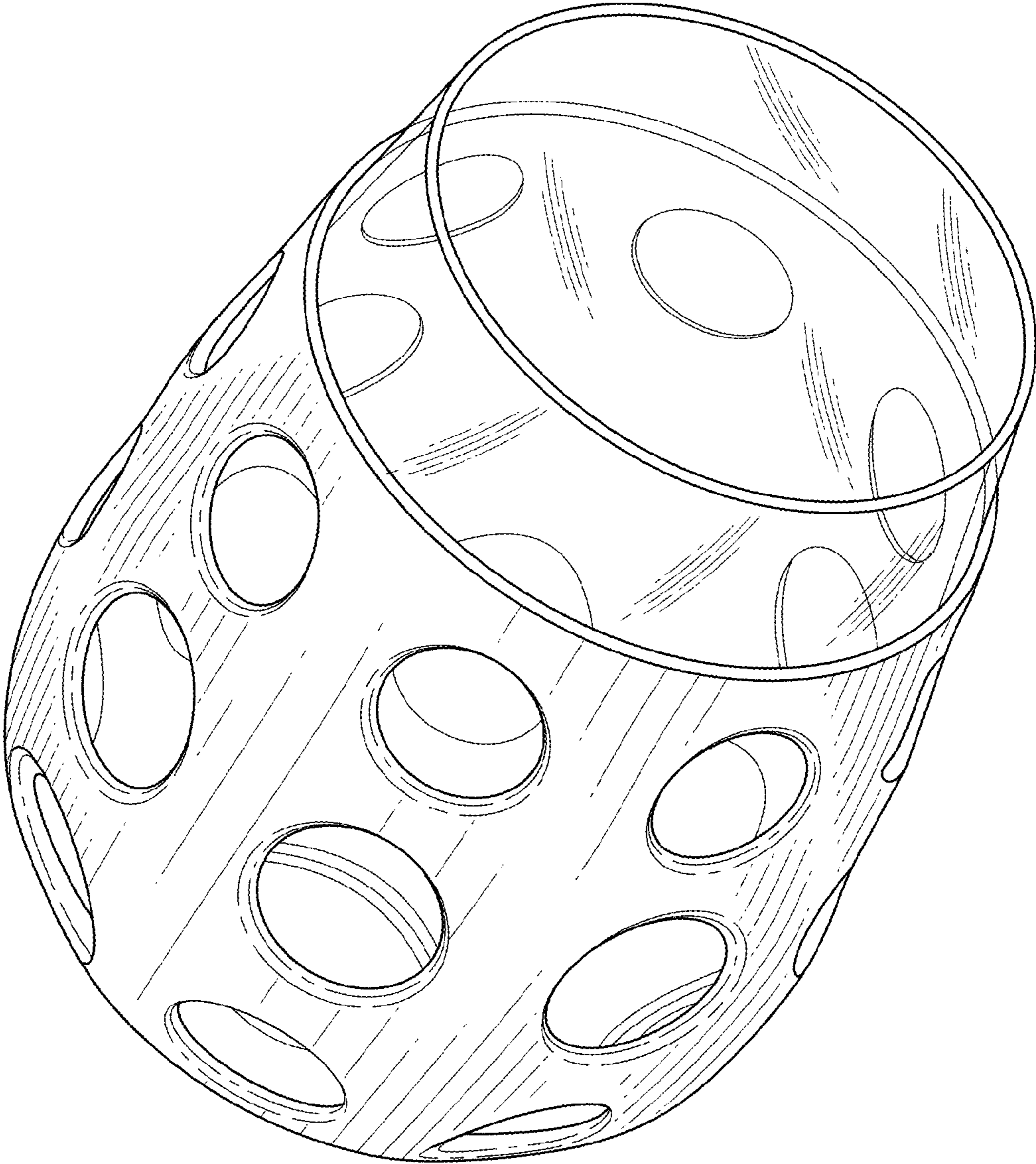

FIG. 8

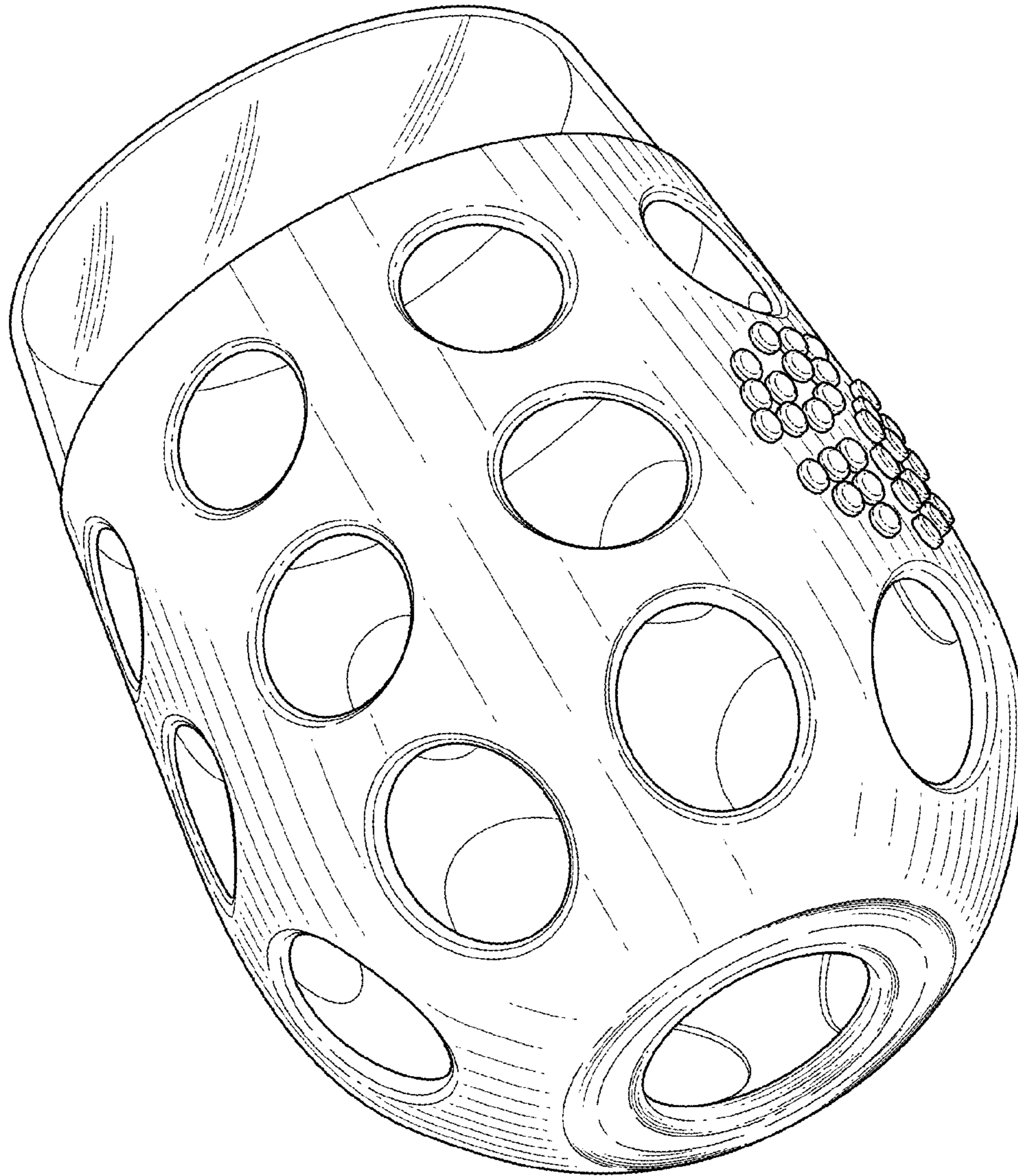

FIG. 9