



US00D700798S

(12) **United States Design Patent**
Wu

(10) **Patent No.:** **US D700,798 S**
(45) **Date of Patent:** **** Mar. 11, 2014**

(54) **MIXER**

(56)

References Cited

(71) Applicant: **Andy Wu**, Fujian (CN)

U.S. PATENT DOCUMENTS

(72) Inventor: **Andy Wu**, Fujian (CN)

(73) Assignee: **Quanzhou Yida Home Appliance Industry Co., Ltd.**, Quanzhou, Fujian (CN)

| | | | | | | |
|----------|---|---|---------|---------------|-------|--------|
| D345,076 | S | * | 3/1994 | Saltet | | D7/376 |
| D383,938 | S | * | 9/1997 | Littmann | | D7/376 |
| D392,504 | S | * | 3/1998 | Lallemand | | D7/376 |
| D398,809 | S | * | 9/1998 | Henderson | | D7/376 |
| D400,756 | S | * | 11/1998 | Henderson | | D7/376 |
| D408,214 | S | * | 4/1999 | Cousins | | D7/376 |
| D426,105 | S | * | 6/2000 | Littmann | | D7/376 |
| D447,380 | S | * | 9/2001 | Feil | | D7/376 |
| D510,837 | S | * | 10/2005 | Lloyd et al. | | D7/376 |
| D534,032 | S | * | 12/2006 | Lloyd | | D7/380 |
| D592,447 | S | * | 5/2009 | Blaise | | D7/380 |
| D651,846 | S | * | 1/2012 | Roseby et al. | | D7/380 |
| D663,157 | S | * | 7/2012 | Nordwall | | D7/380 |

(**) Term: **14 Years**

(21) Appl. No.: **29/452,546**

* cited by examiner

(22) Filed: **Apr. 18, 2013**

(51) **LOC (10) Cl.** **31-00**

Primary Examiner — Ricky Pham

(52) **U.S. Cl.**

(74) *Attorney, Agent, or Firm* — Alan Kamrath; Kamrath IP Lawfirm, P.A.

USPC **D7/379**; D7/376; D7/377; D7/378

(58) **Field of Classification Search**

(57) **CLAIM**

The ornamental designs for a mixer, as shown and described.

USPC D7/301–313, 316–326, 354–357, 368, D7/372–386, 391–398, 402, 412–415, 503, D7/515, 543, 584–587, 607, 665–666, 679, D7/691–693; 99/280, 326, 348, 492, 99/508–512; 241/30–37.5, 82.1, 92, 98, 241/101.01–101.2, 166–169.1, 172, 272, 241/282.2, 285.1–285.3, 291, 292.1; 366/64–67, 98, 129, 142–144, 169.1, 366/192–211, 241–254, 262, 279–292, 314, 366/325.8, 325.92, 341–347; 416/75–77, 416/70 R, 163

DESCRIPTION

FIG. 1 is a perspective view of a mixer showing my new design;
FIG. 2 is a front elevational view thereof;
FIG. 3 is a rear elevational view thereof;
FIG. 4 is a left side elevational view thereof;
FIG. 5 is a right side elevational view thereof;
FIG. 6 is a top plan view thereof; and,
FIG. 7 is a bottom plan view.

See application file for complete search history.

1 Claim, 7 Drawing Sheets

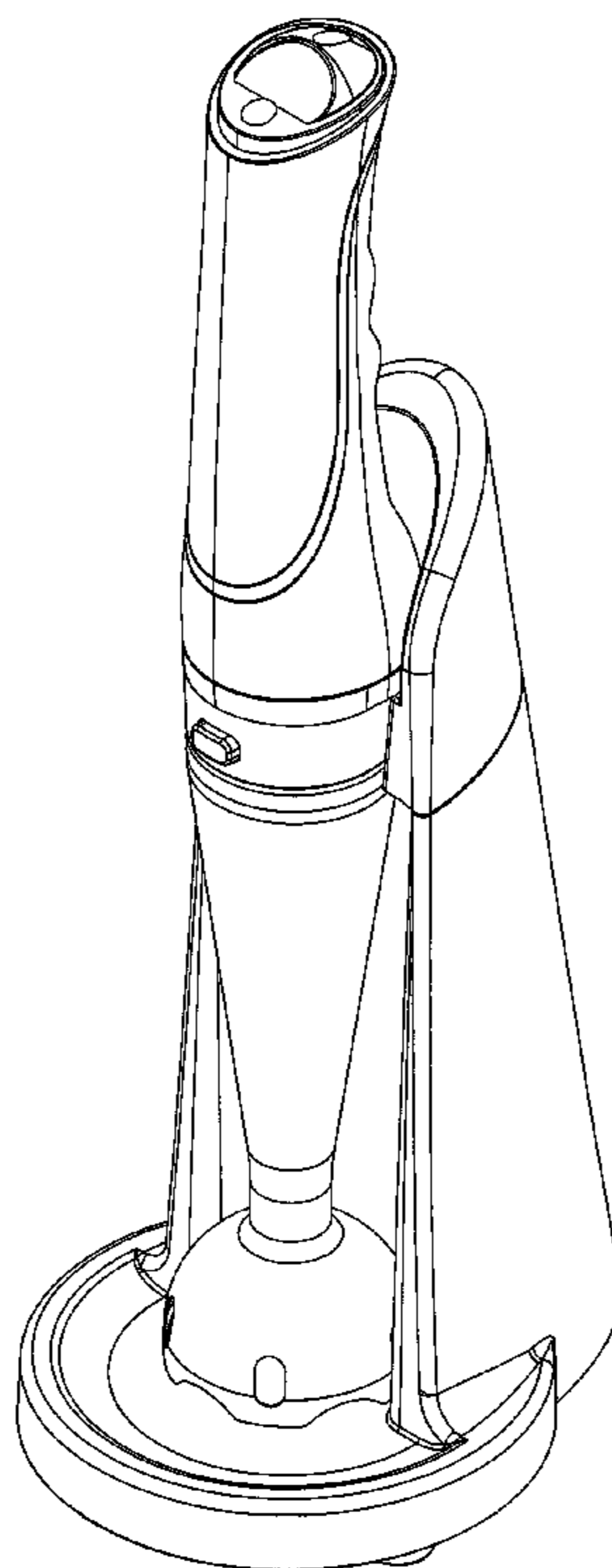

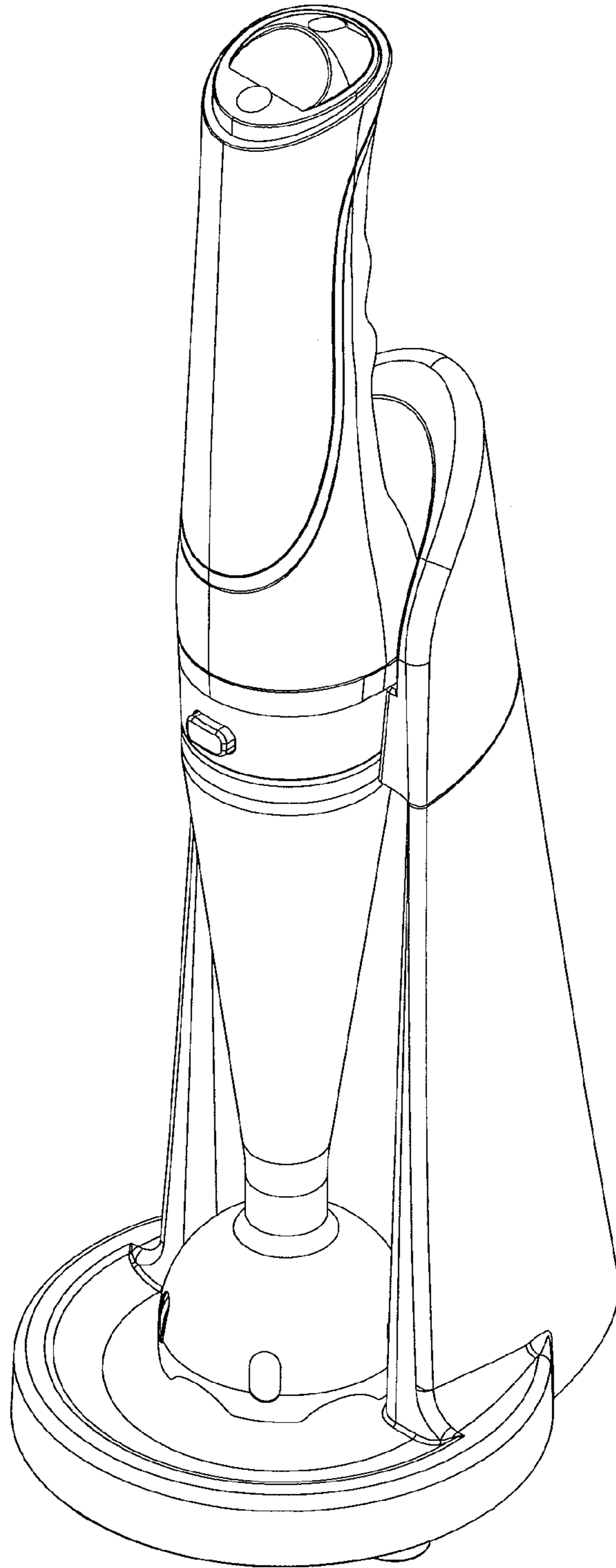

FIG. 1

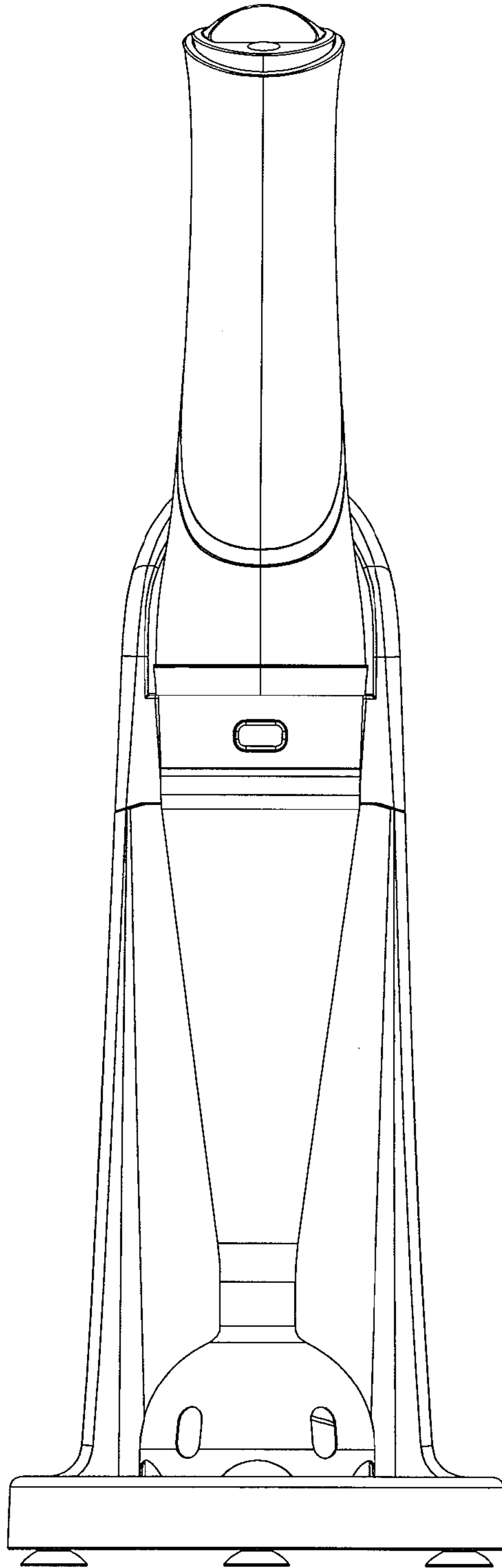

FIG. 2

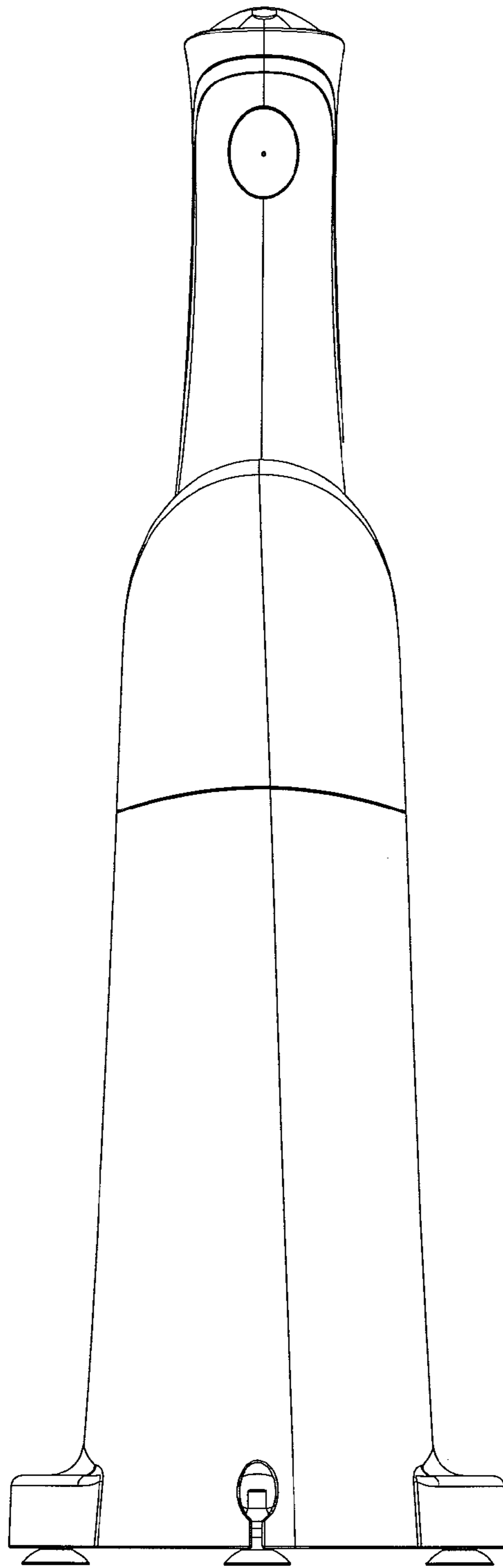

FIG. . 3

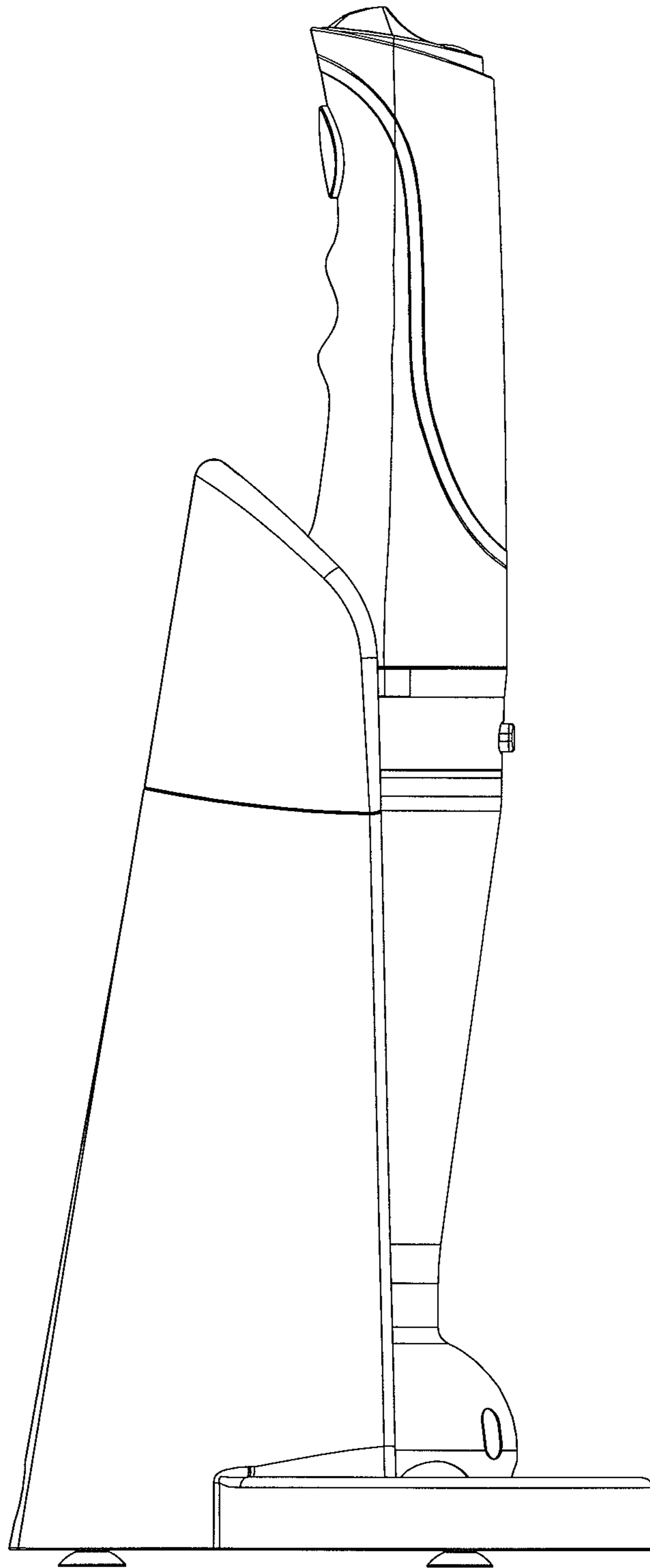

FIG. 4

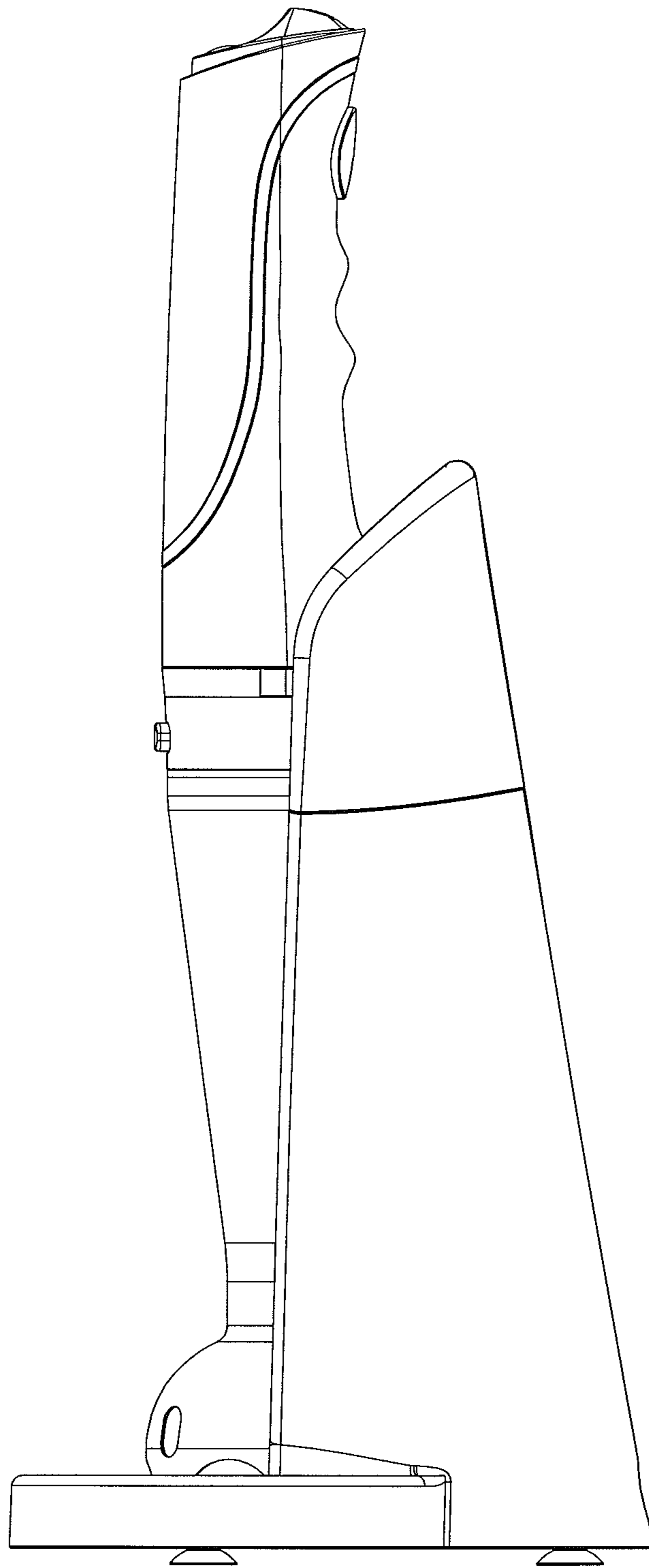

FIG. 5

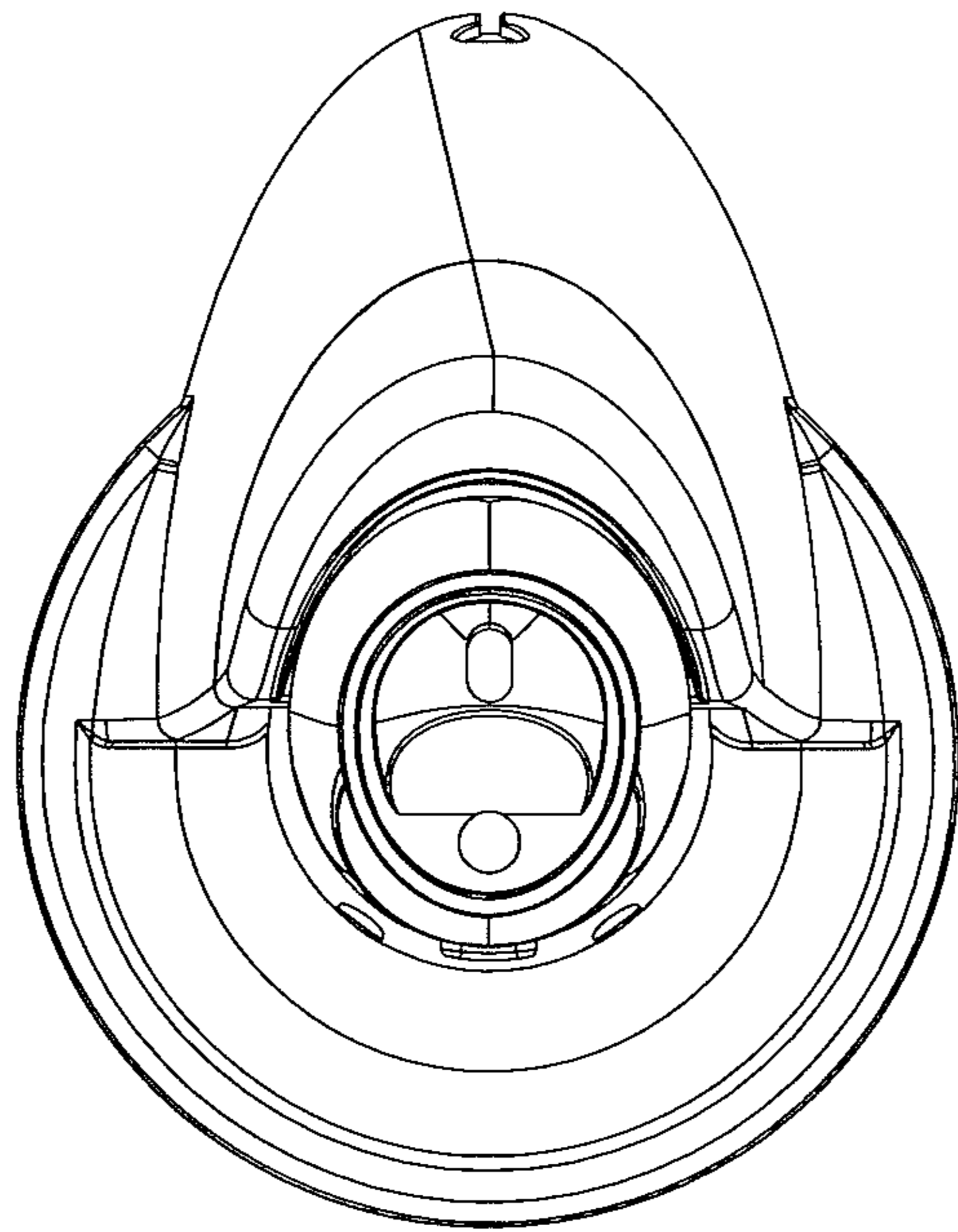

FIG. 6

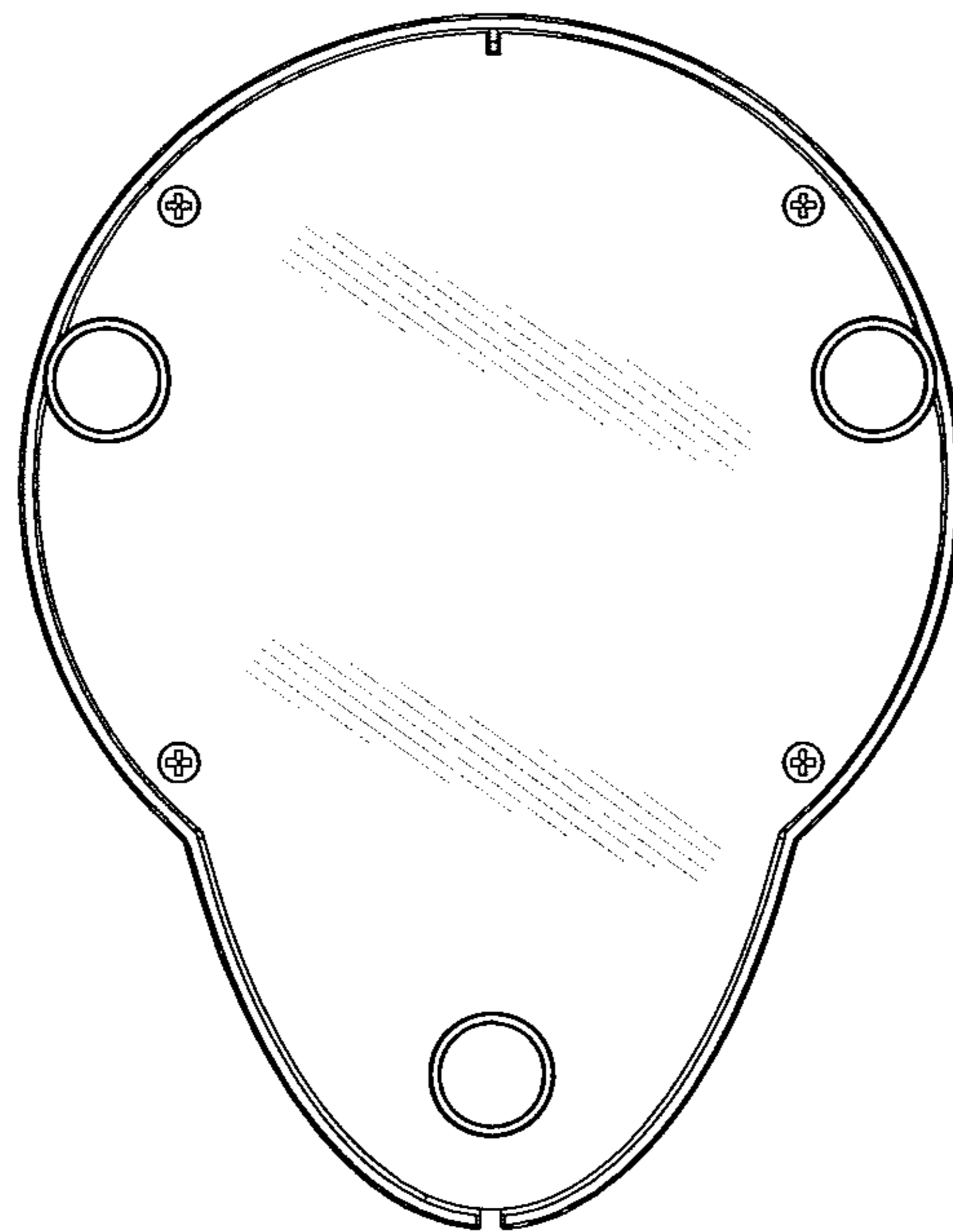

FIG. 7