



US00D700777S

(12) **United States Design Patent**  
**Shitrit et al.**

(10) **Patent No.:** **US D700,777 S**  
(45) **Date of Patent:** **\*\* Mar. 11, 2014**

(54) **TOOL BOX**  
(75) Inventors: **Elad Hay Shitrit, Tel-Aviv (IL); Omri Lifshitz, Tel-Aviv (IL)**  
(73) Assignee: **The Stanley Works Israel, Ltd. (IL)**  
(\*\*) Term: **14 Years**  
(21) Appl. No.: **29/430,690**  
(22) Filed: **Aug. 29, 2012**

D630,851 S \* 1/2011 Landau et al. .... D3/279  
D639,055 S \* 6/2011 Fraiman et al. .... D3/276  
D668,048 S \* 10/2012 Vilkomirski et al. .... D3/281  
D672,555 S \* 12/2012 Shitrit ..... D3/281  
2011/0181008 A1\* 7/2011 Bensman et al. .... 280/47.26

\* cited by examiner

*Primary Examiner* — Jennifer Rivard

(74) *Attorney, Agent, or Firm* — Bruce S. Shapiro; John Yun; Stephen R. Valancius

(30) **Foreign Application Priority Data**

Apr. 23, 2012 (EM) ..... 001323208

(51) **LOC (10) CL.** ..... **03-01**

(52) **U.S. CL.**  
USPC ..... **D3/281; D3/905**

(58) **Field of Classification Search**  
USPC ..... D3/273, 276, 281, 282, 283–286, 294,  
D3/295, 297, 905; 206/372–379, 349;  
220/523, 524, 527, 4.27  
See application file for complete search history.

(56) **References Cited**

**U.S. PATENT DOCUMENTS**

D609,913 S \* 2/2010 Landau ..... D3/321  
D629,607 S \* 12/2010 Sabbag et al. .... D3/282

(57) **CLAIM**

The ornamental design for a tool box, as shown and described.

**DESCRIPTION**

FIG. 1 is a left front perspective view of our new design.  
FIG. 2 is a left side view thereof.  
FIG. 3 is a right side view thereof.  
FIG. 4 is a front view thereof.  
FIG. 5 is a rear view thereof.  
FIG. 6 is a top view thereof; and,  
FIG. 7 is a bottom view thereof.  
The broken lines shown in the drawings illustrate portions of the tool box and form no part of the claimed design.

**1 Claim, 4 Drawing Sheets**

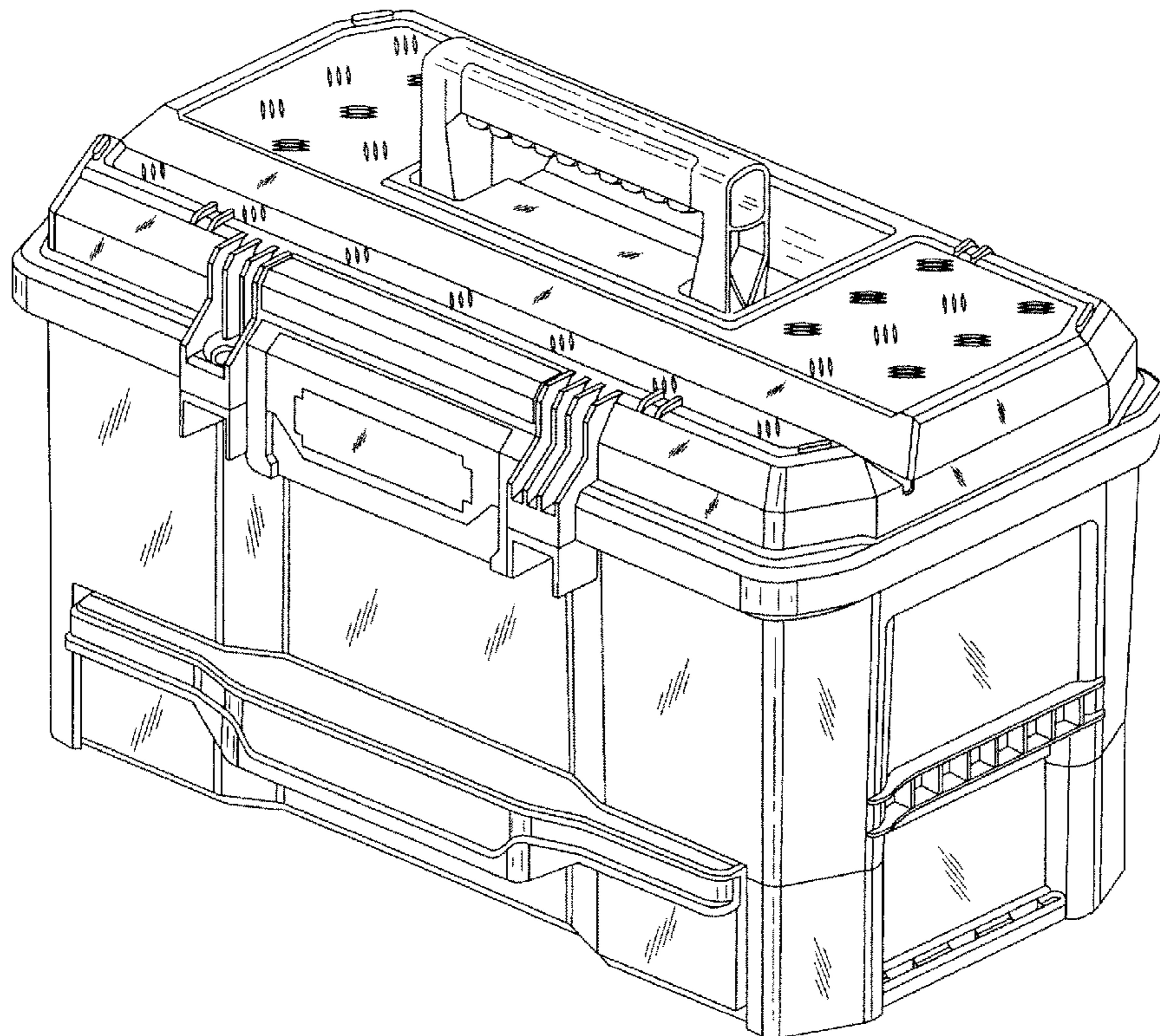

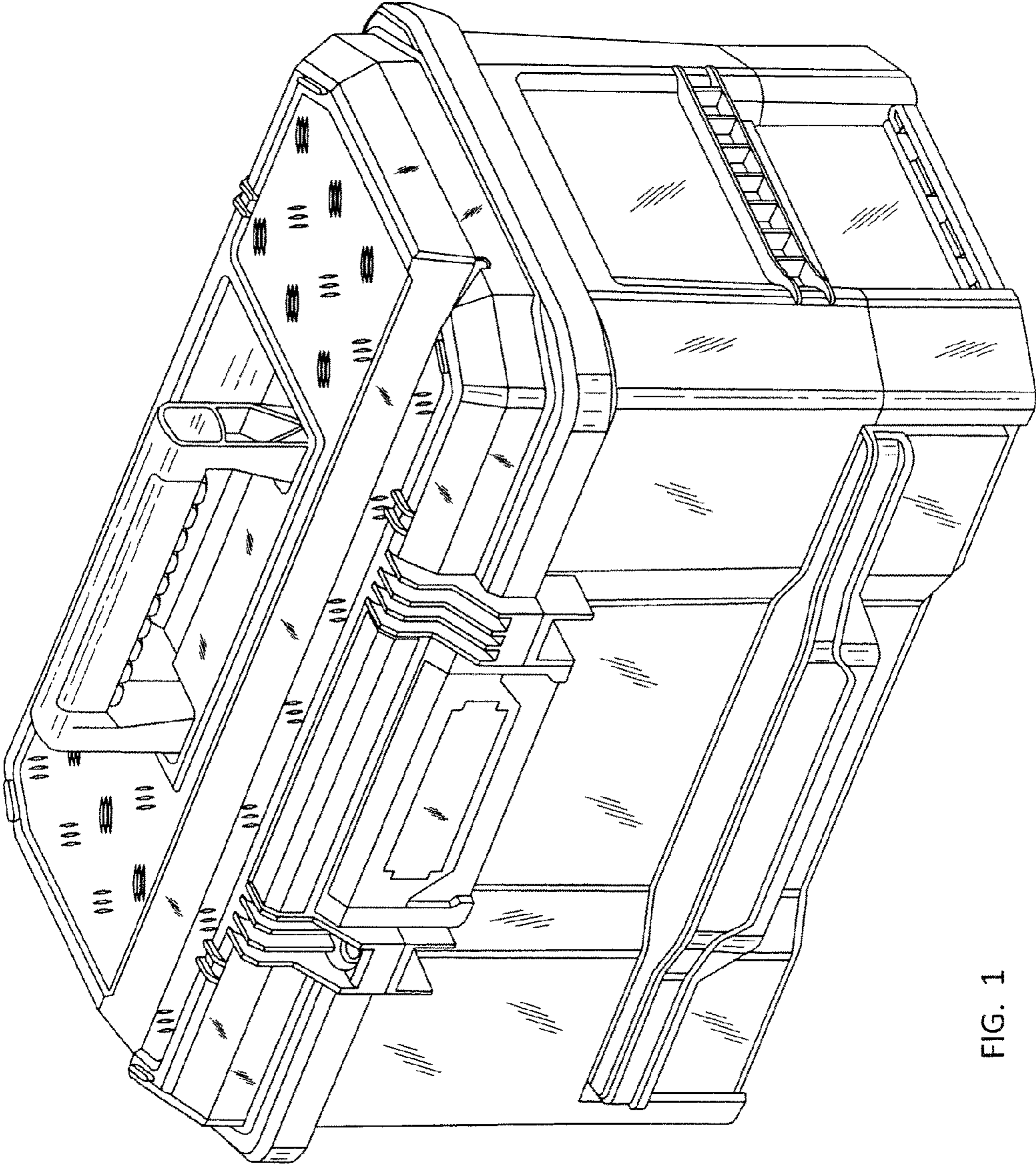

FIG. 1

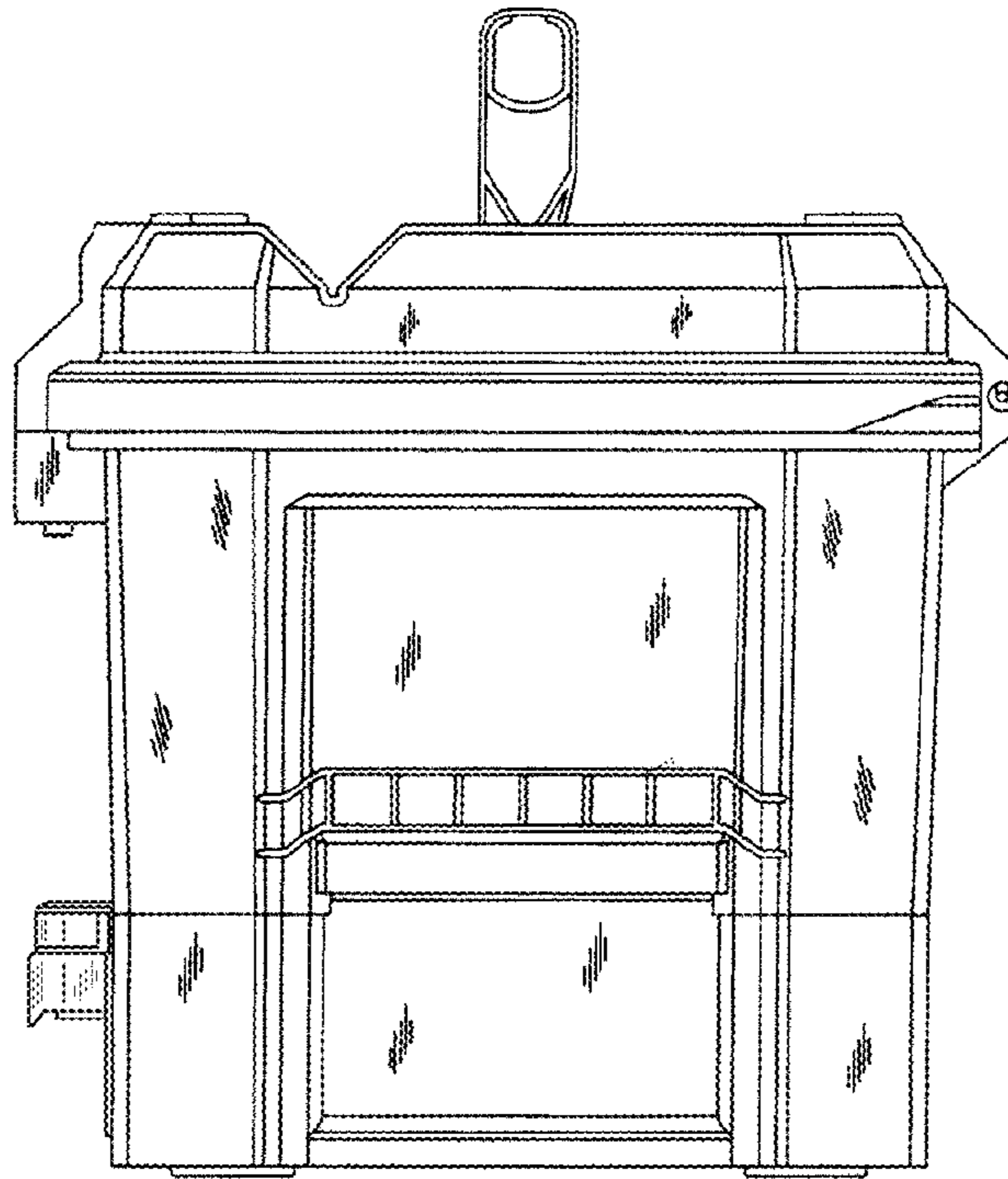

FIG. 2

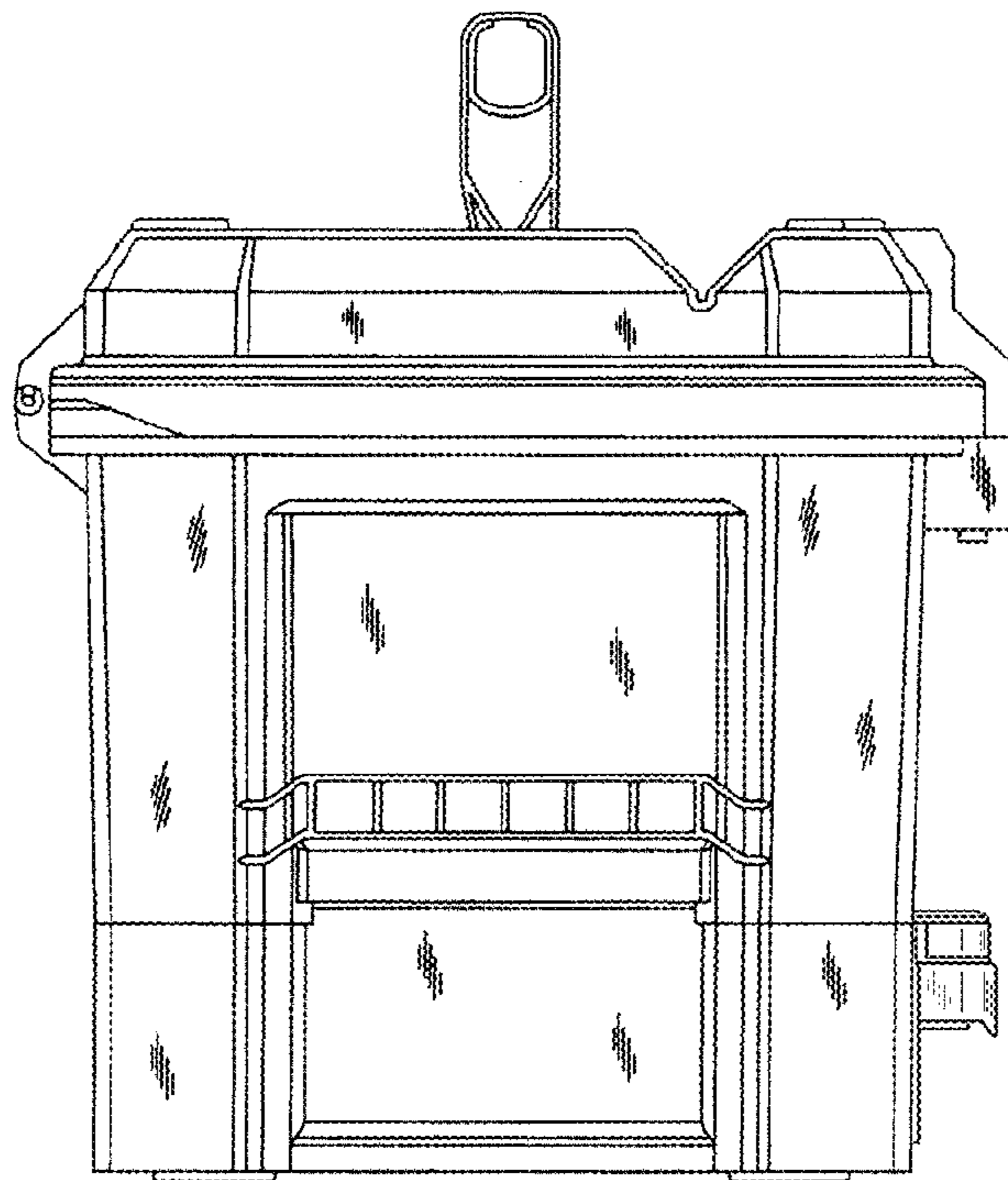

FIG. 3

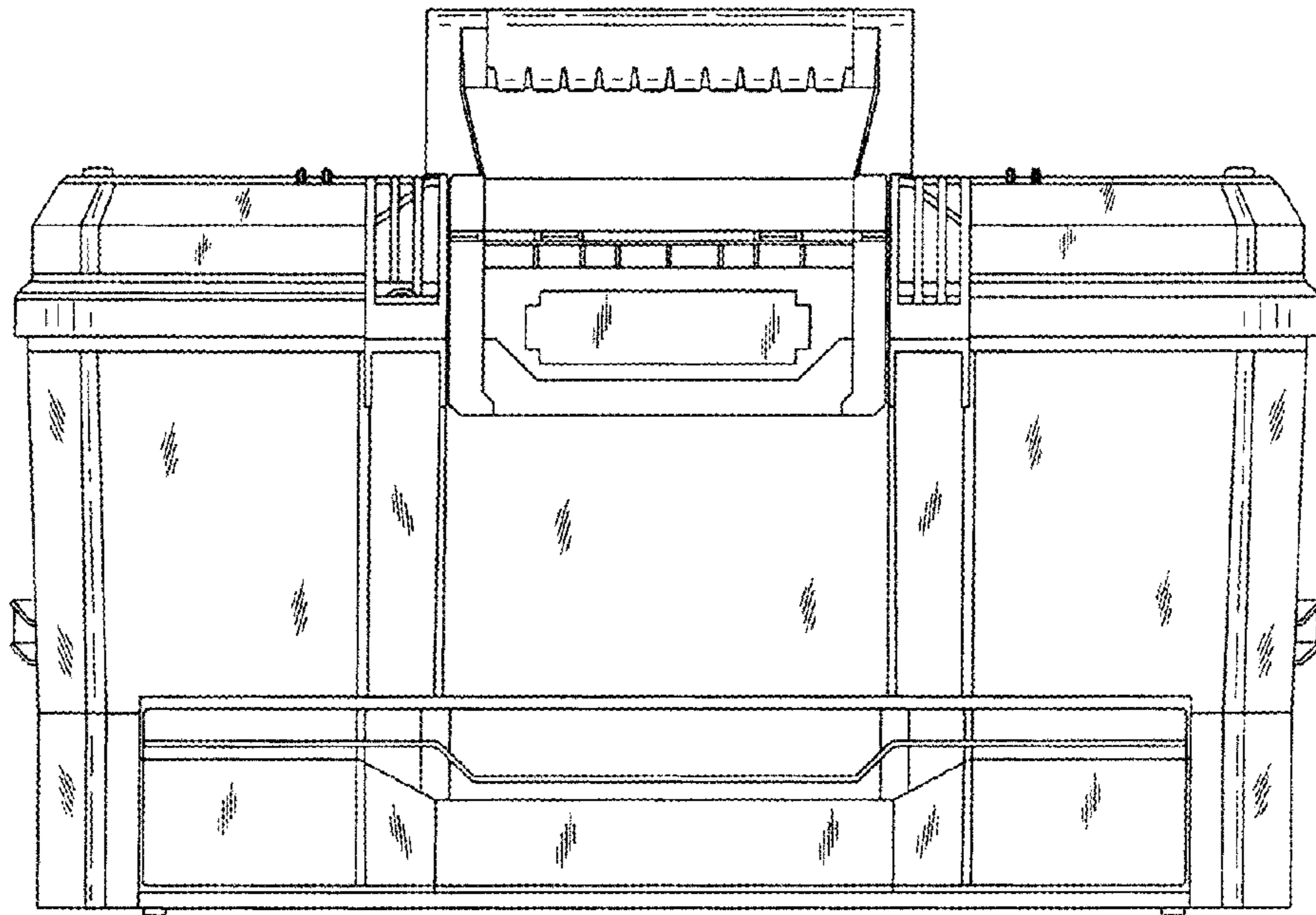

FIG. 4

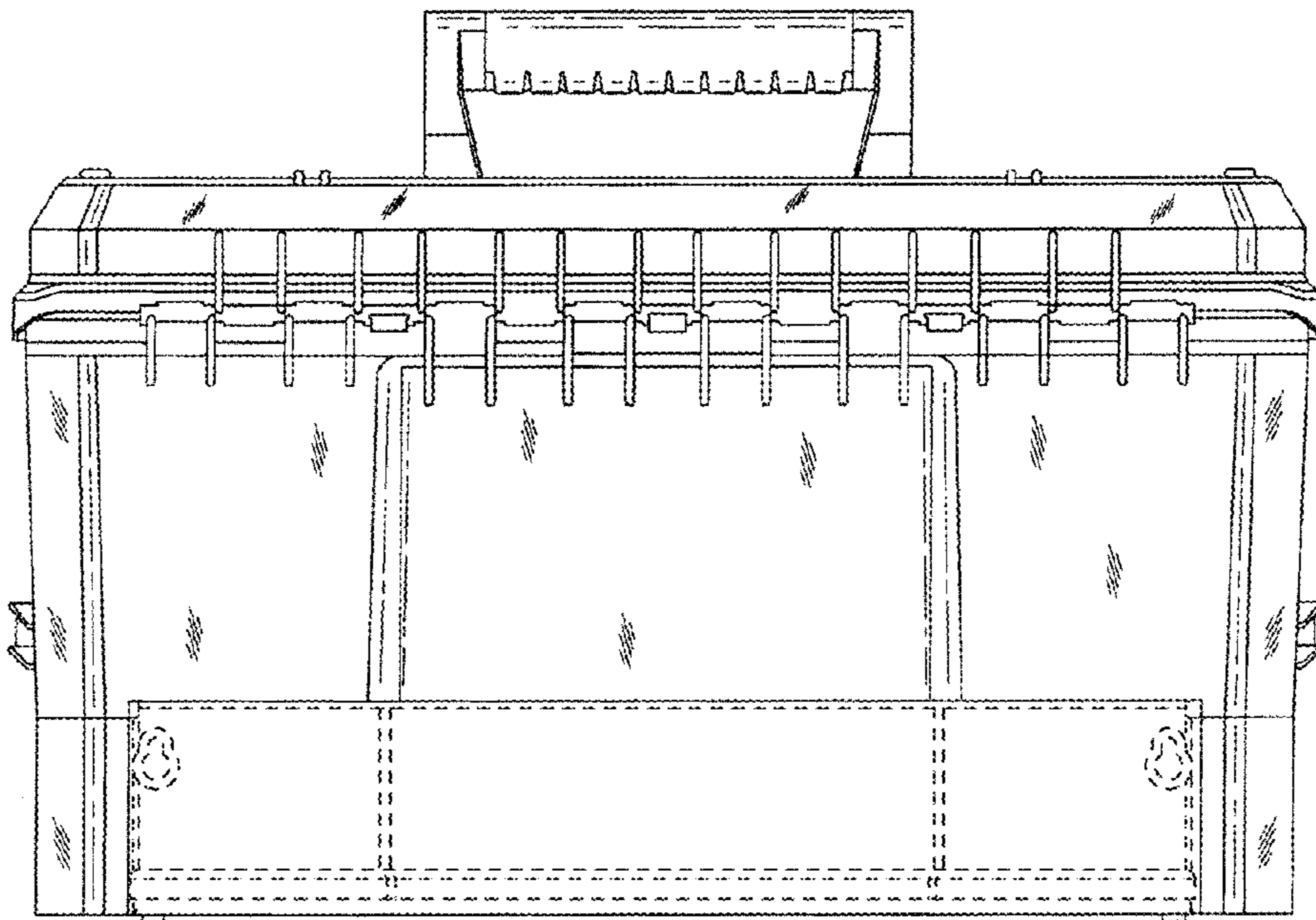

FIG. 5

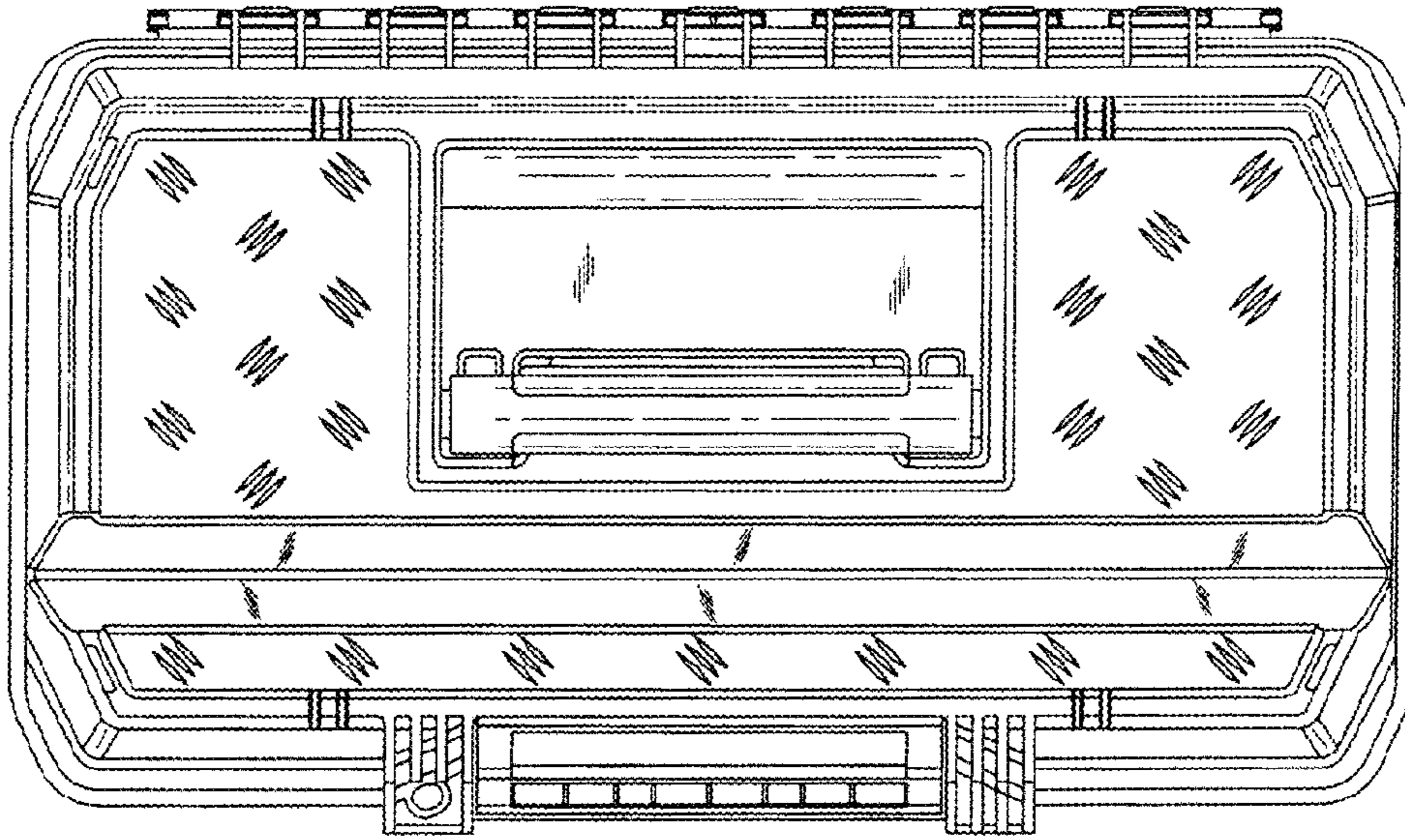

FIG. 6

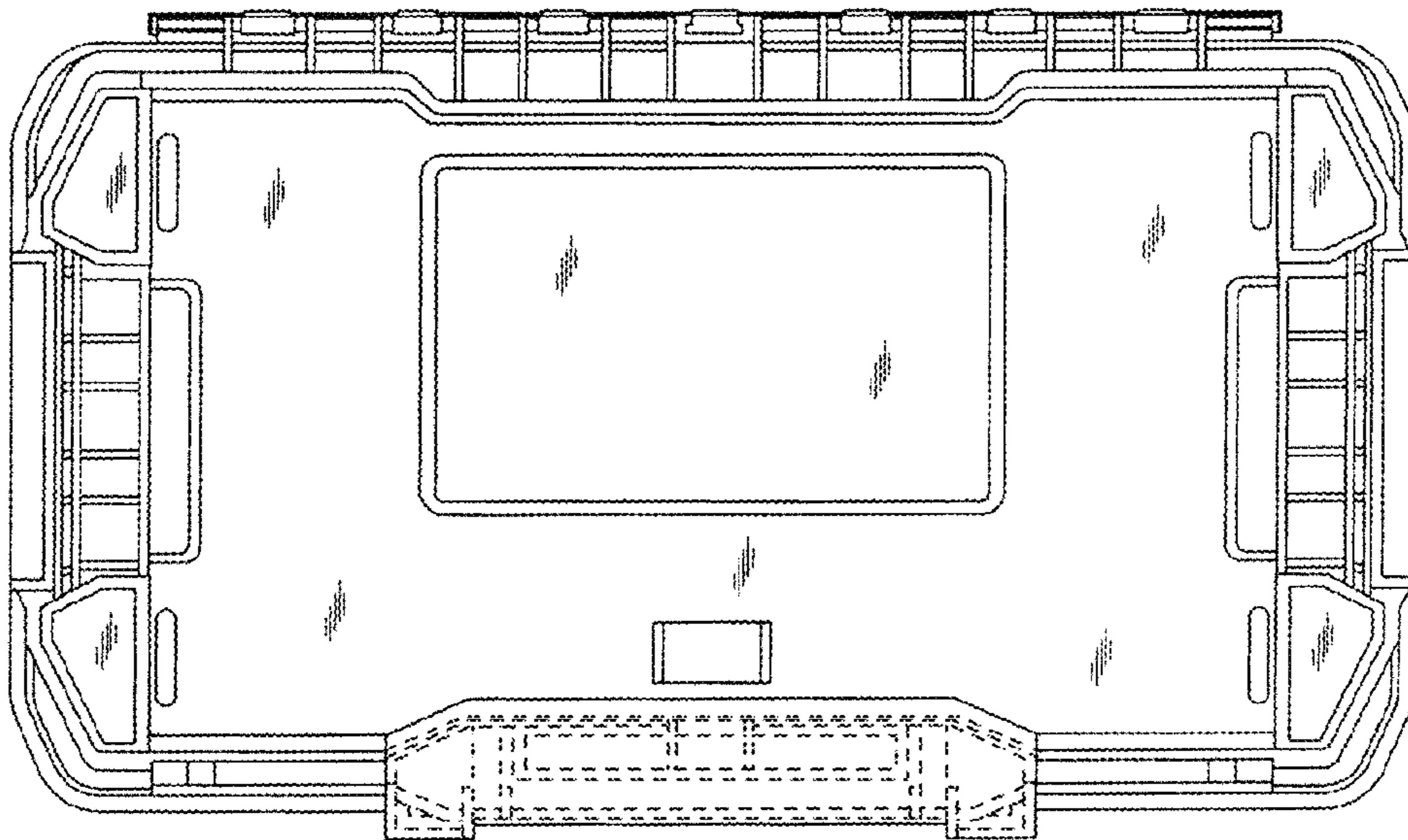

FIG. 7