

US00D700684S

(12) **United States Design Patent**
Madenci

(10) **Patent No.:** **US D700,684 S**
(45) **Date of Patent:** **** Mar. 4, 2014**

- (54) **PORTABLE URINAL**
- (71) Applicant: **Erdogan Madenci**, Tucson, AZ (US)
- (72) Inventor: **Erdogan Madenci**, Tucson, AZ (US)
- (**) Term: **14 Years**
- (21) Appl. No.: **29/458,907**
- (22) Filed: **Jun. 24, 2013**
- (51) **LOC (10) Cl.** **23-02**
- (52) **U.S. Cl.**
USPC **D23/274; D6/643.1; D25/31**
- (58) **Field of Classification Search**
USPC **D23/273-274, 32, 309; D25/16, 31;**
D6/643.1, 644; 4/664, 301, DIG. 15
See application file for complete search history.

D460,813 S * 7/2002 Lundstrom D23/302
 6,668,392 B2 * 12/2003 Mason 4/462
 7,299,511 B2 * 11/2007 Quan 4/664
 8,141,185 B2 * 3/2012 Hoffjann et al. 4/664
 D683,864 S * 6/2013 Taylor et al. D25/16

* cited by examiner

Primary Examiner — Robert Delehanty

(74) *Attorney, Agent, or Firm* — Dale F. Regelman; Quarles & Brady LLP

(57) **CLAIM**

The ornamental design for a portable urinal, as shown and described.

DESCRIPTION

FIG. 1 is a perspective view of the design of this invention;
 FIG. 2 is a first side view;
 FIG. 3 is a second side view;
 FIG. 4 is a third side view;
 FIG. 5 is a fourth side view;
 FIG. 6 is a top view; and,
 FIG. 7 is a bottom view.

The broken line showing a portion of the urinal is for illustrative purposes that forms no part of the claimed design.

1 Claim, 6 Drawing Sheets

(56) **References Cited**

U.S. PATENT DOCUMENTS

D219,519 S * 12/1970 Gianfagna D6/421
 D305,706 S * 1/1990 Mark D6/421
 D360,781 S * 8/1995 Hill et al. D6/455
 5,647,074 A * 7/1997 White et al. 4/664
 D412,625 S * 8/1999 Montague et al. D6/421
 D460,539 S * 7/2002 Lundstrom D23/302

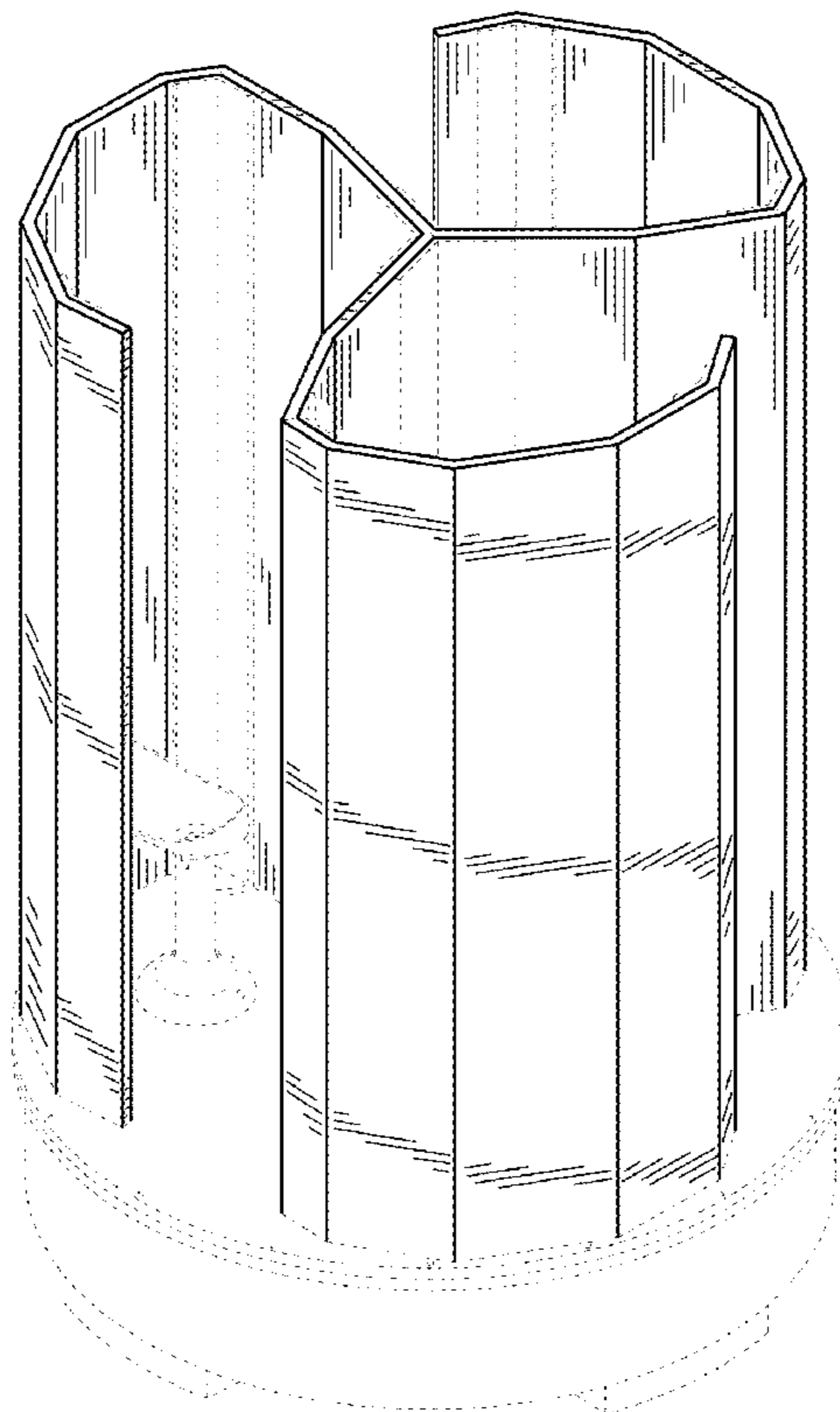

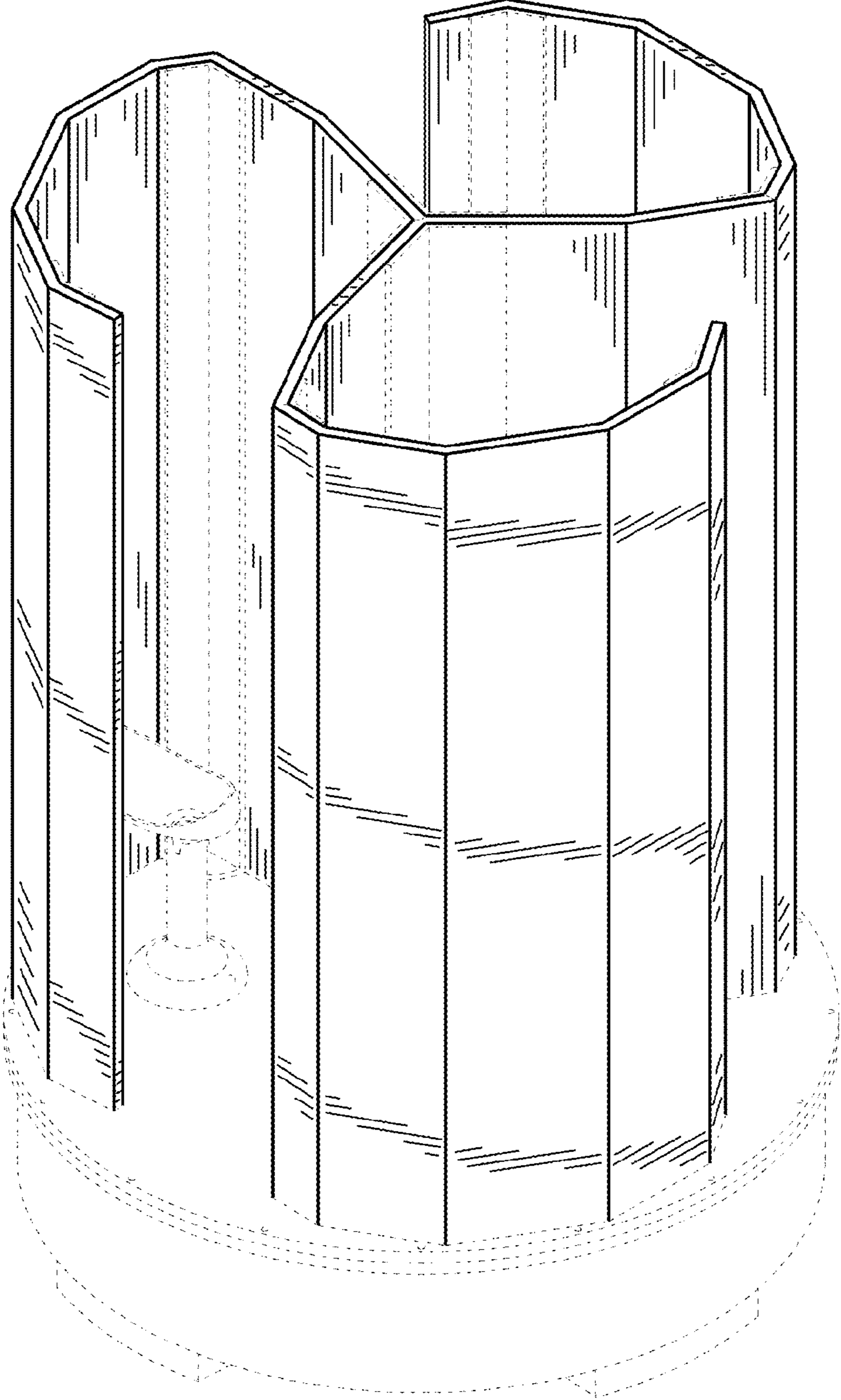

FIG. 1

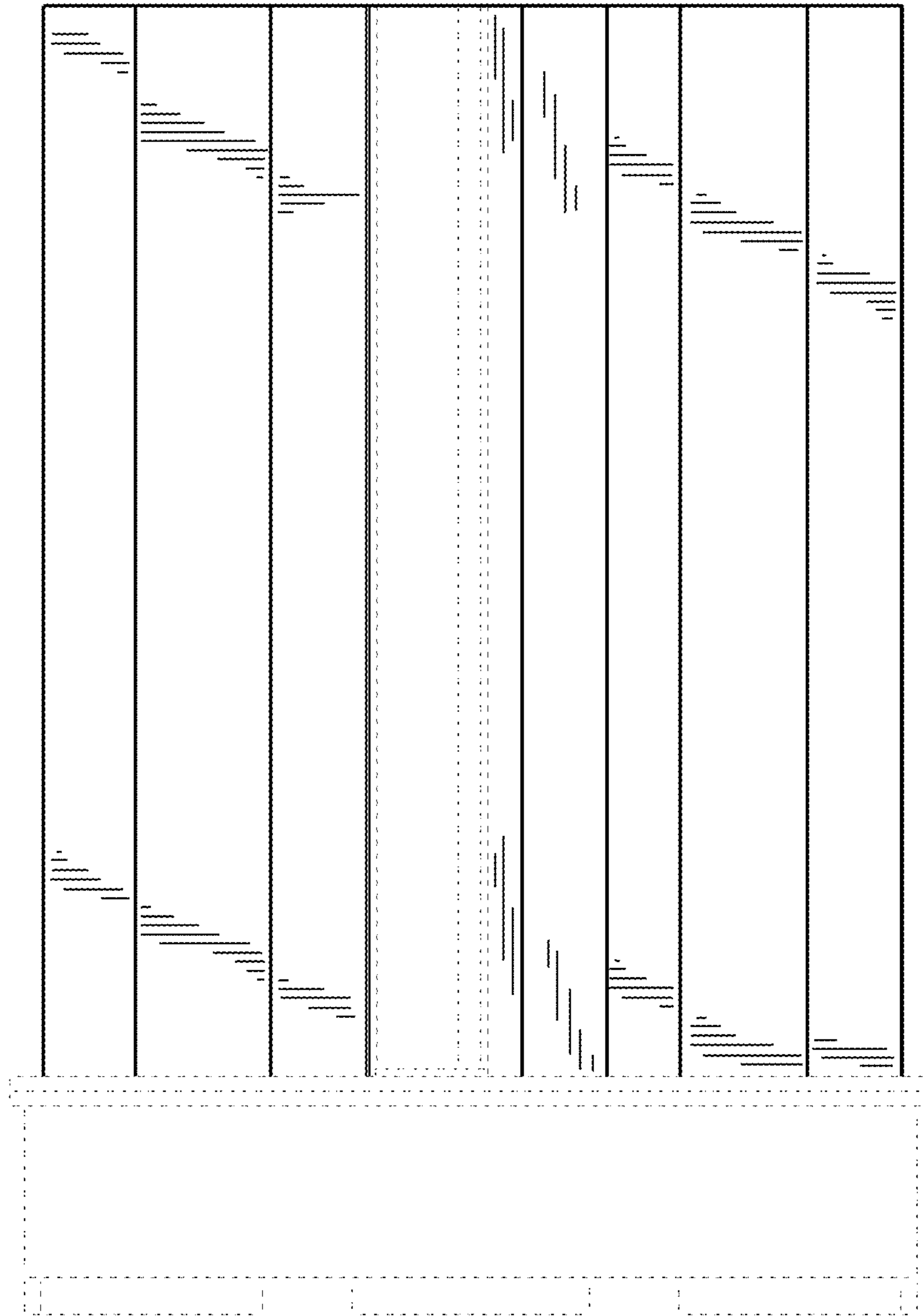

FIG. 2

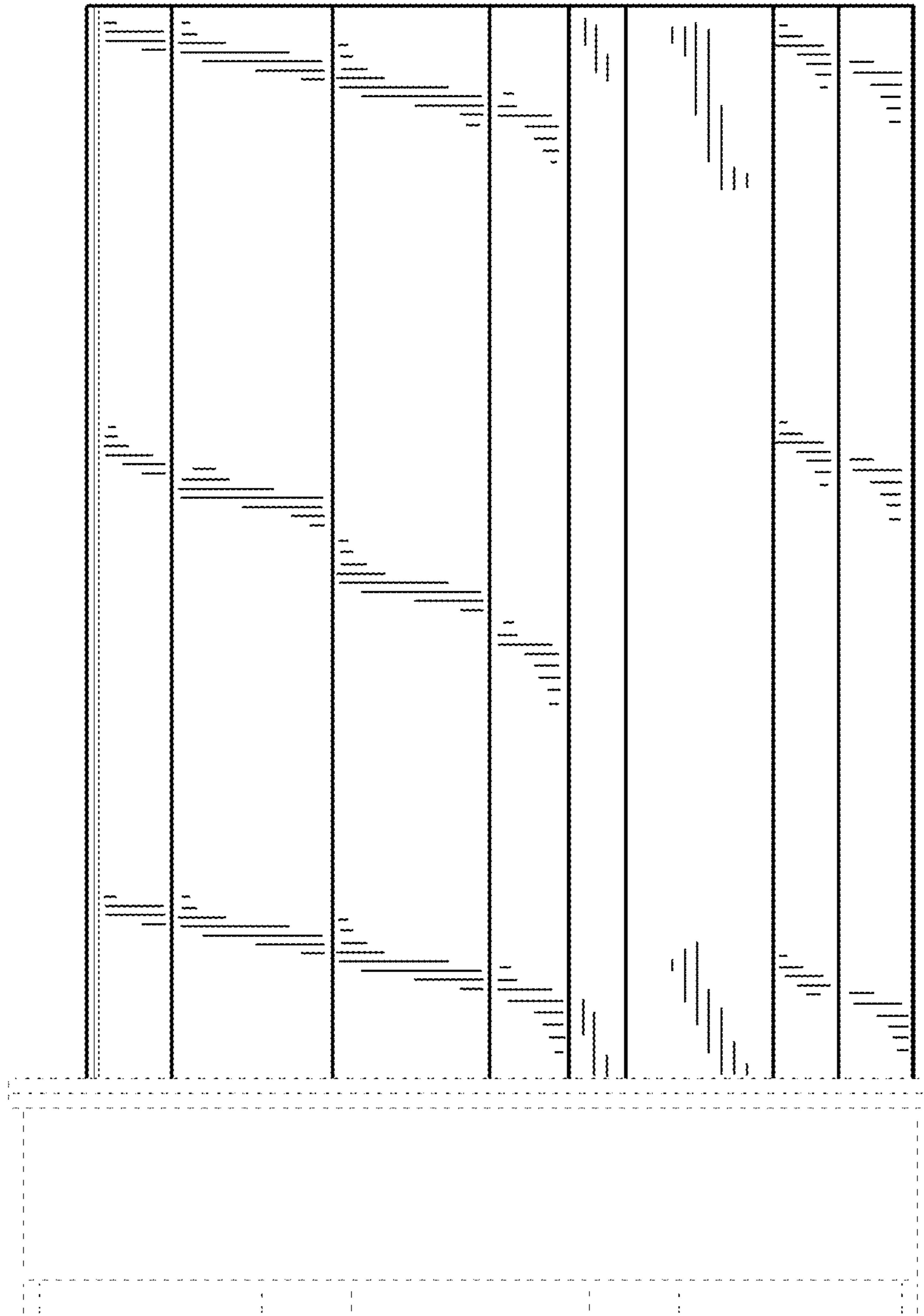

FIG. 3

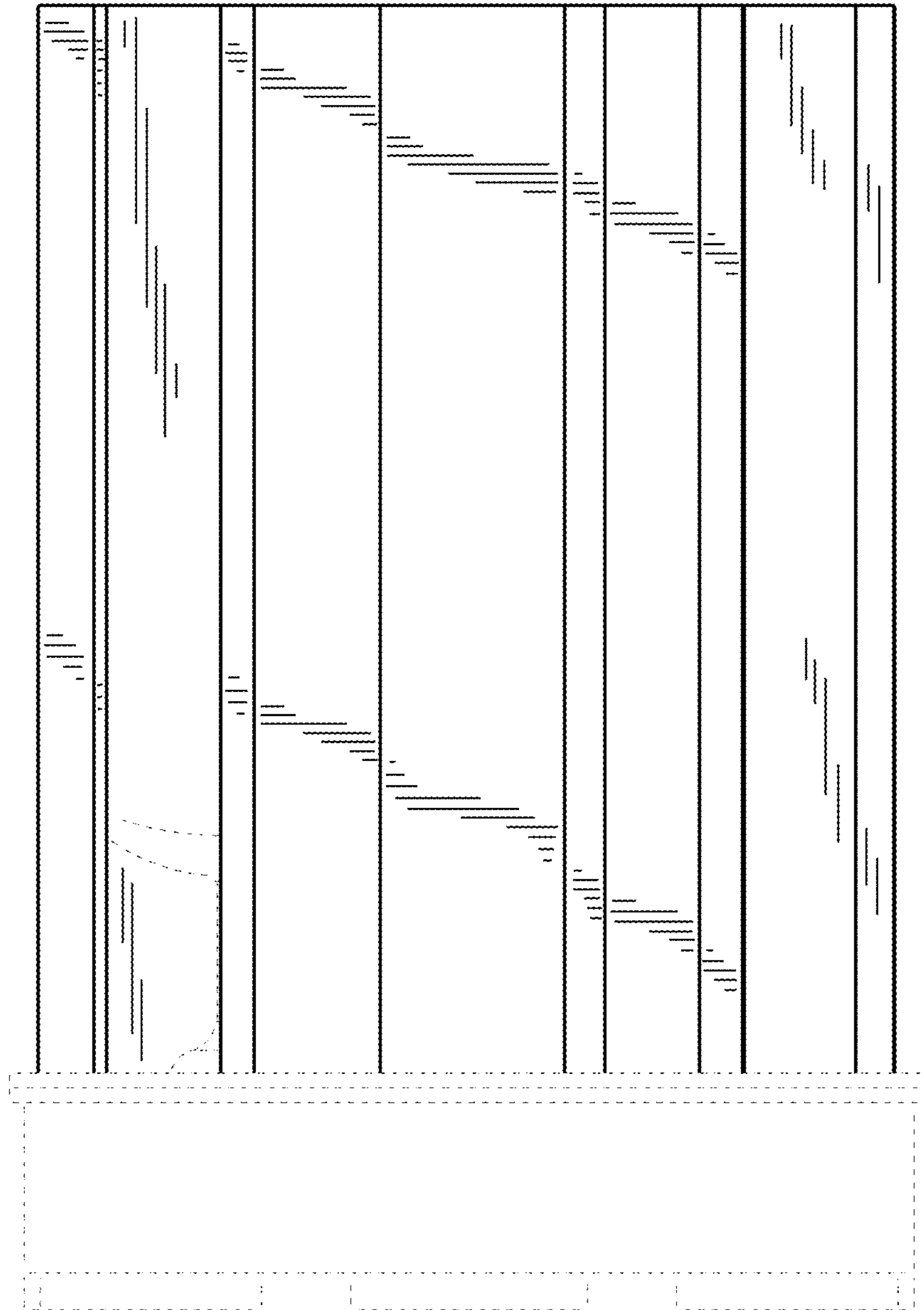

FIG. 4

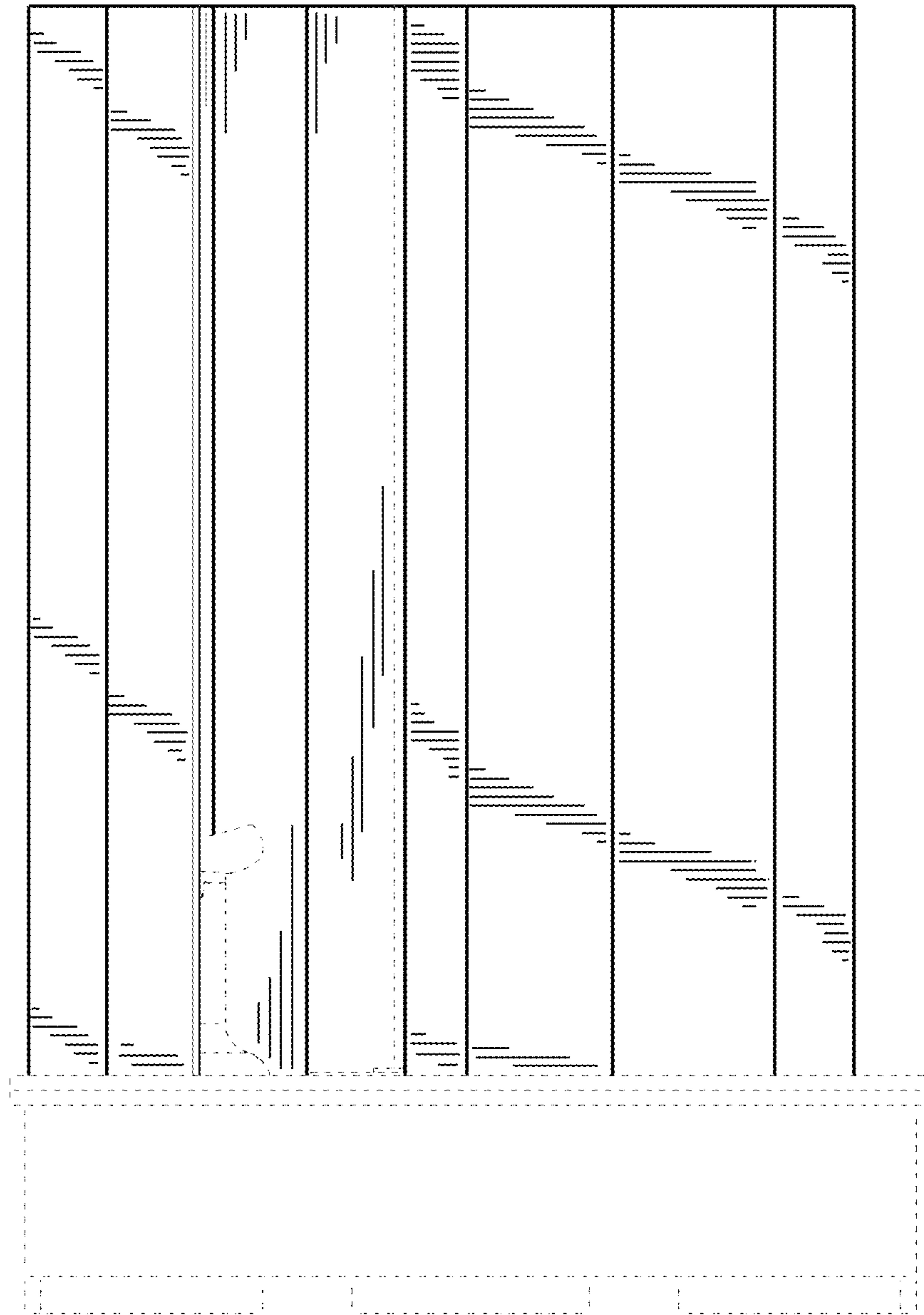

FIG. 5

FIG. 6

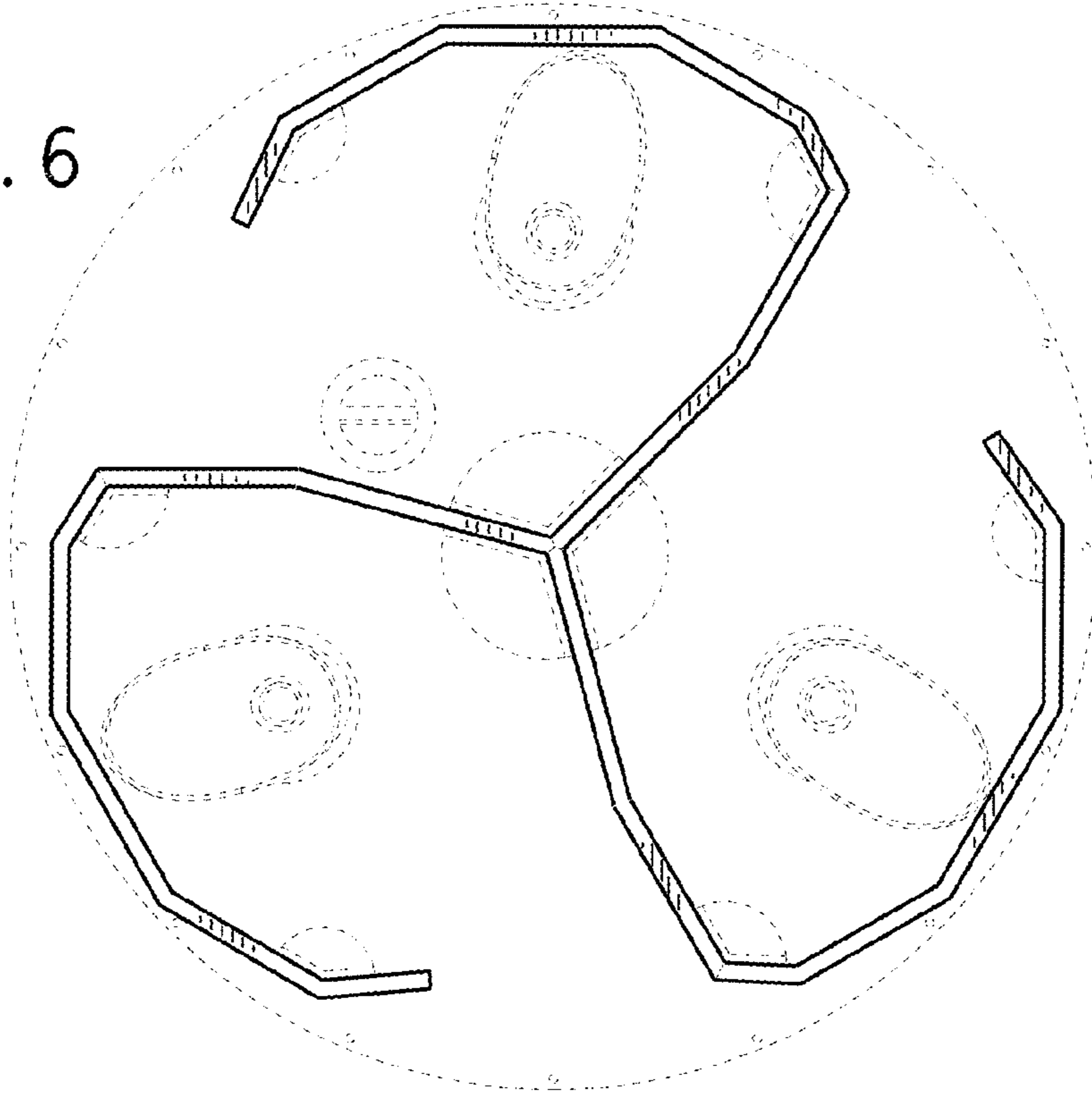

FIG. 7

