



US00D700675S

(12) **United States Design Patent**  
**Seeds et al.**

(10) **Patent No.:** **US D700,675 S**  
(45) **Date of Patent:** **\*\* Mar. 4, 2014**

- (54) **KNIFE**
- (71) Applicant: **Fiskars Brands, Inc.**, Madison, WI (US)
- (72) Inventors: **Darrin Seeds**, Vancouver, WA (US);  
**Peter Schuft**, Portland, OR (US);  
**Patrick Hunt**, Carlton, OR (US)
- (73) Assignee: **Fiskars Brands, Inc.**, Madison, WI (US)
- (\*\*) Term: **14 Years**
- (21) Appl. No.: **29/447,909**
- (22) Filed: **Mar. 7, 2013**
- (51) **LOC (10) Cl.** ..... **22-02**
- (52) **U.S. Cl.**  
USPC ..... **D22/118**
- (58) **Field of Classification Search**  
USPC ..... D22/118; D8/95-99; 30/151, 160-161,  
30/314, 340; D7/649  
See application file for complete search history.

(56) **References Cited**

**U.S. PATENT DOCUMENTS**

4,825,552 A	5/1989	Bendickson et al.
D366,408 S	1/1996	Sessions et al.
5,511,310 A	4/1996	Sessions et al.
5,596,808 A	1/1997	Lake et al.
D383,370 S	9/1997	Chen et al.
D410,189 S	5/1999	Wehrs et al.

(Continued)

**OTHER PUBLICATIONS**

U.S. Appl. No. 10/366,647, filed Feb. 13, 2003, Freeman, Jeff.

(Continued)

*Primary Examiner* — Catheri Oliver-Garcia  
(74) *Attorney, Agent, or Firm* — Foley & Lardner LLP

(57) **CLAIM**

We claim the ornamental design for a knife, as shown and described.

**DESCRIPTION**

FIG. 1 is a front top perspective view of the claimed design according to one embodiment;  
 FIG. 2 is a front view of the claimed design of FIG. 1;  
 FIG. 3 is a rear view of the claimed design of FIG. 1;  
 FIG. 4 is a left side view of the claimed design of FIG. 1;  
 FIG. 5 is a right side view of the claimed design of FIG. 1;  
 FIG. 6 is a top view of the claimed design of FIG. 1;  
 FIG. 7 is a bottom view of the claimed design of FIG. 1;  
 FIG. 8 is a rear top perspective view of the claimed design of FIG. 1;  
 FIG. 9 is a front top perspective view of the claimed design according to another embodiment;  
 FIG. 10 is a front view of the claimed design of FIG. 9;  
 FIG. 11 is a rear view of the claimed design of FIG. 9;  
 FIG. 12 is a left side view of the claimed design of FIG. 9;  
 FIG. 13 is a right side view of the claimed design of FIG. 9;  
 FIG. 14 is a top view of the claimed design of FIG. 9;  
 FIG. 15 is a bottom view of the claimed design of FIG. 9; and,  
 FIG. 16 is a rear top perspective view of the claimed design of FIG. 9.

The broken lines in the drawings are for purposes of illustrating unclaimed portions of the design.

**1 Claim, 8 Drawing Sheets**

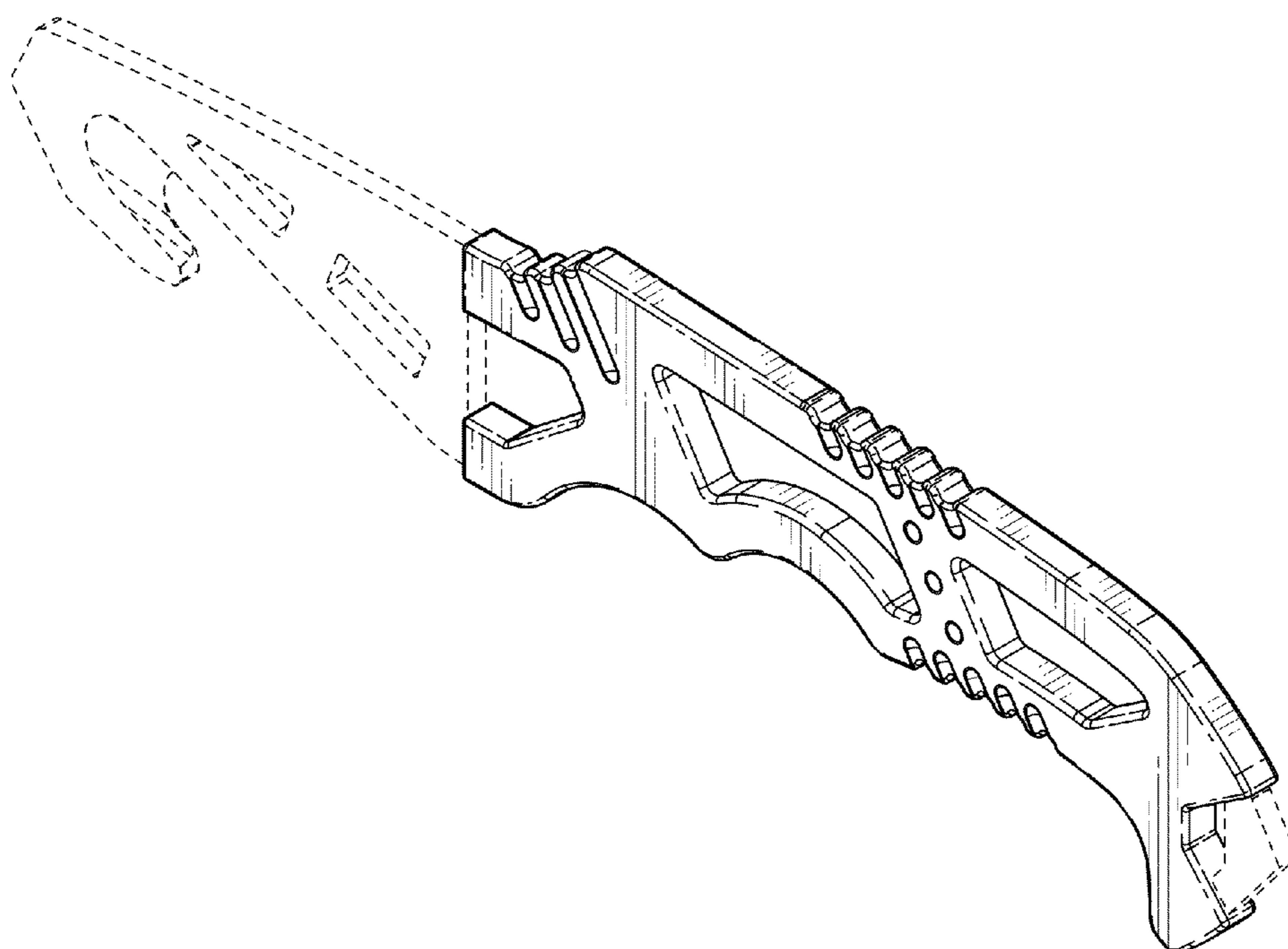

(56)

**References Cited**

U.S. PATENT DOCUMENTS

D413,503	S	9/1999	Dugdale	
6,354,007	B1	3/2002	Scarla	
6,688,003	B2	2/2004	Scarla	
D494,437	S	8/2004	Scarla	
6,915,577	B2	7/2005	Scala	
D519,798	S	5/2006	Dallas	
D548,814	S *	8/2007	Fuller .....	D22/118
D553,468	S	10/2007	Freeman	
7,302,760	B2	12/2007	Lake	
D581,241	S	11/2008	Freeman	
D582,243	S	12/2008	Freeman et al.	
D582,747	S	12/2008	Freeman et al.	
D607,530	S *	1/2010	Craffey .....	D22/118
D610,646	S	2/2010	Harsey et al.	
D614,933	S	5/2010	Freeman et al.	
D636,051	S	4/2011	Freeman et al.	
D636,052	S	4/2011	Freeman et al.	
D636,053	S	4/2011	Freeman et al.	
D638,904	S	5/2011	Freeman et al.	

D639,632	S	6/2011	Freeman et al.	
D661,367	S	6/2012	Seeds et al.	
D672,841	S *	12/2012	Pelton .....	D22/118
D672,842	S *	12/2012	Pelton .....	D22/118
2002/0066187	A1	6/2002	Jennings	
2004/0158991	A1	8/2004	Freeman	
2005/0055833	A1	3/2005	Scarla	
2005/0252010	A1	11/2005	Freeman	
2006/0064877	A1	3/2006	Vallotton et al.	
2006/0080840	A1	4/2006	Freeman	
2011/0010947	A1	1/2011	Freeman	
2012/0304470	A1	12/2012	Freeman	

OTHER PUBLICATIONS

U.S. Appl. No. 10/605,934, filed Nov. 6, 2003, Scarla, Robert E.  
 U.S. Appl. No. 29/391,770, filed May 12, 2011, Seeds et al.  
 U.S. Appl. No. 29/428,036, filed Jul. 25, 2012, Freeman et al.  
 U.S. Appl. No. 29/428,262, filed Jul. 27, 2012, Cagampang, Juan.  
 U.S. Appl. No. 29/431,026, filed Aug. 31, 2012, Seeds, Darrin.  
 U.S. Appl. No. 29/432,846, filed Sep. 21, 2012, Kyle et al.

\* cited by examiner

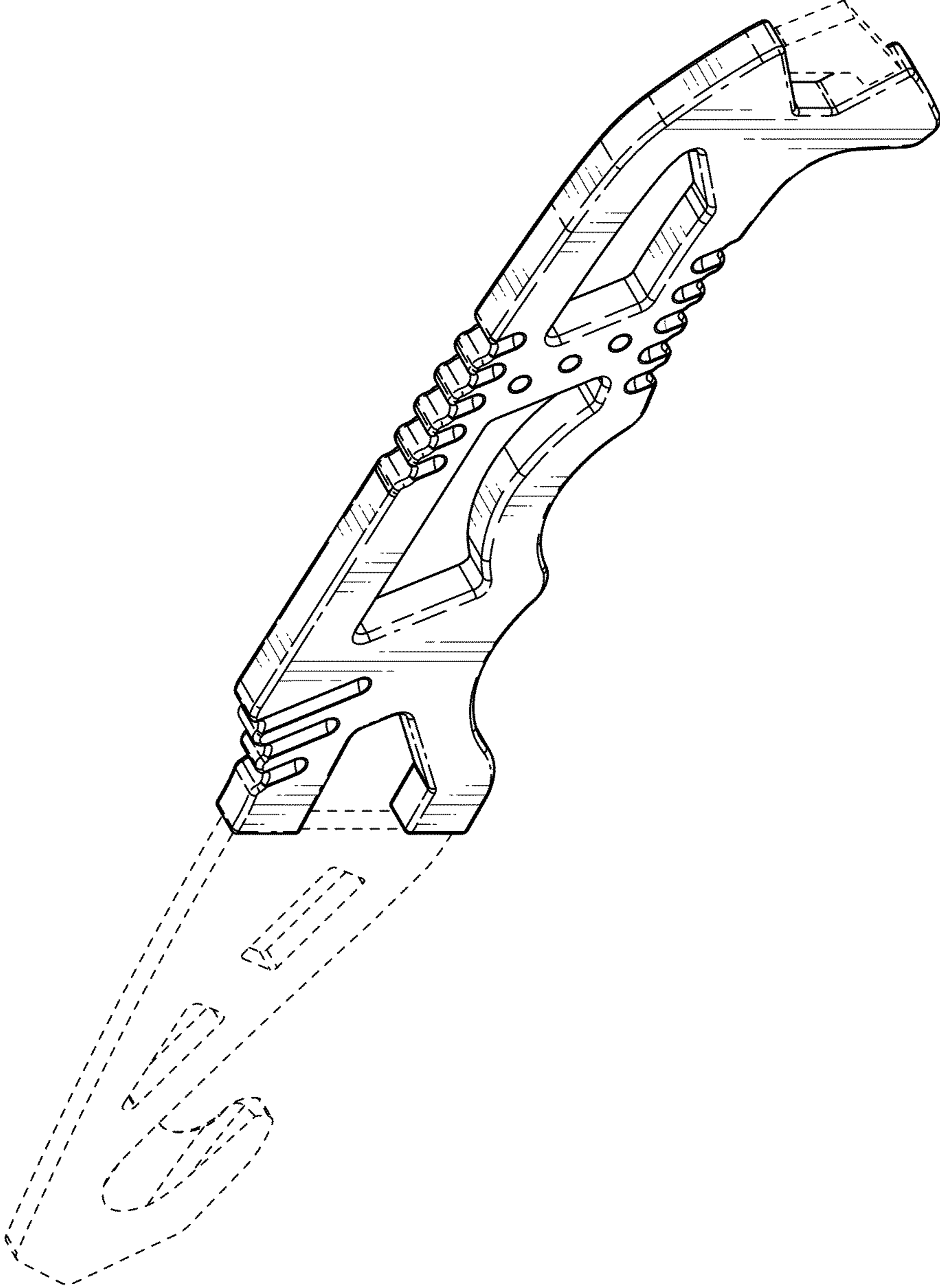

FIG. 1

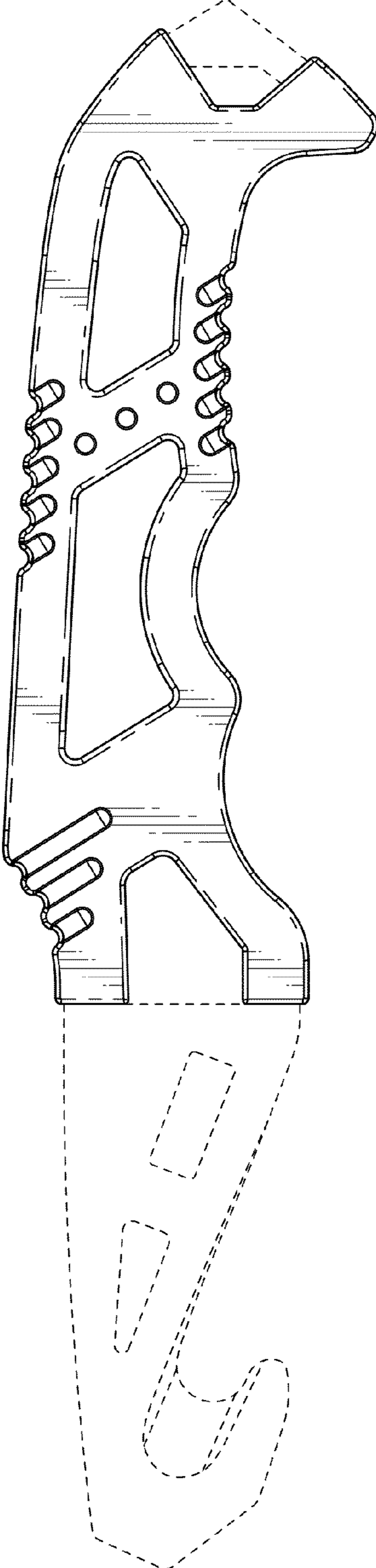

FIG. 2

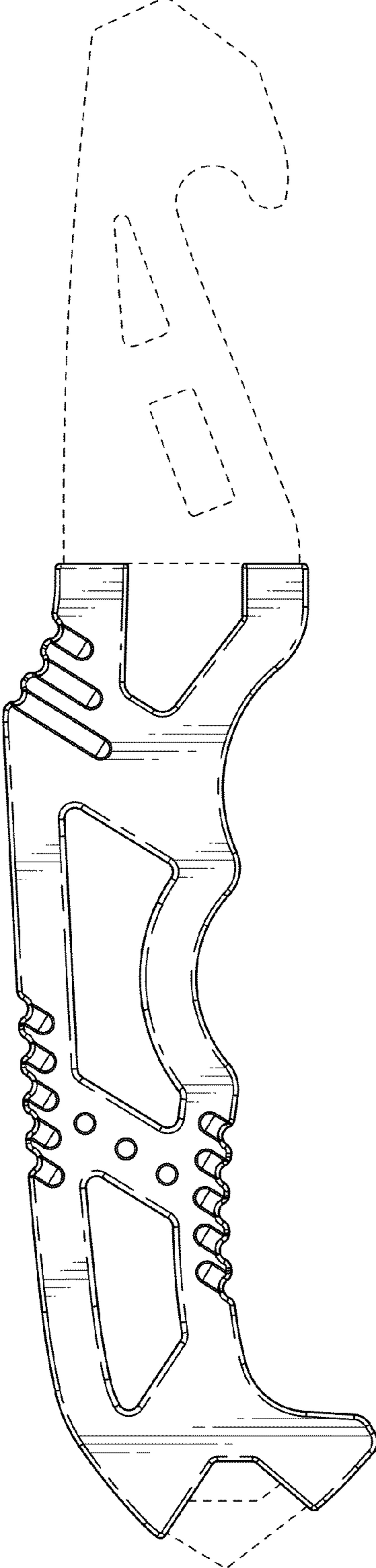

FIG. 3





FIG. 4



FIG. 5



FIG. 6



FIG. 7

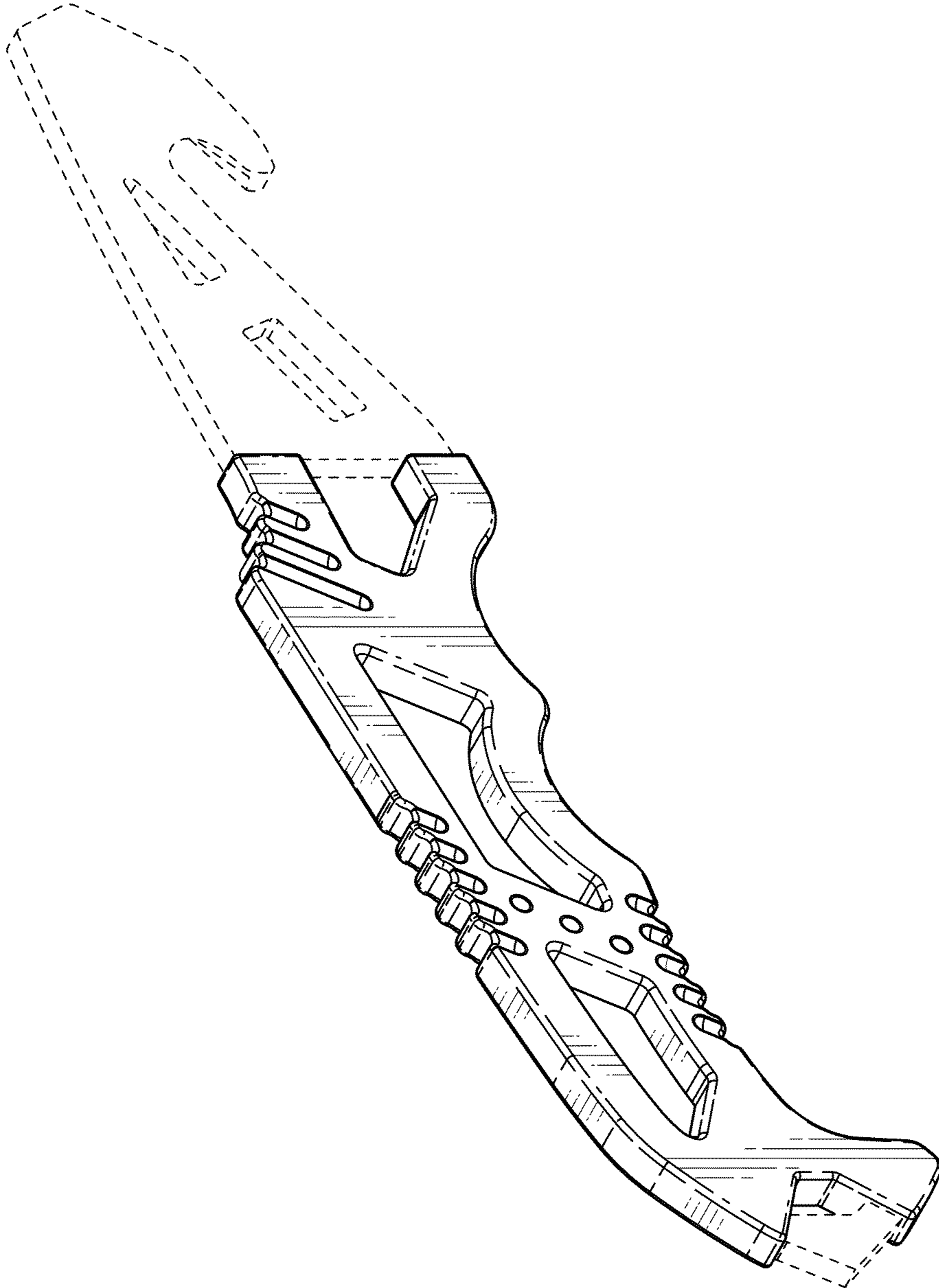

FIG. 8

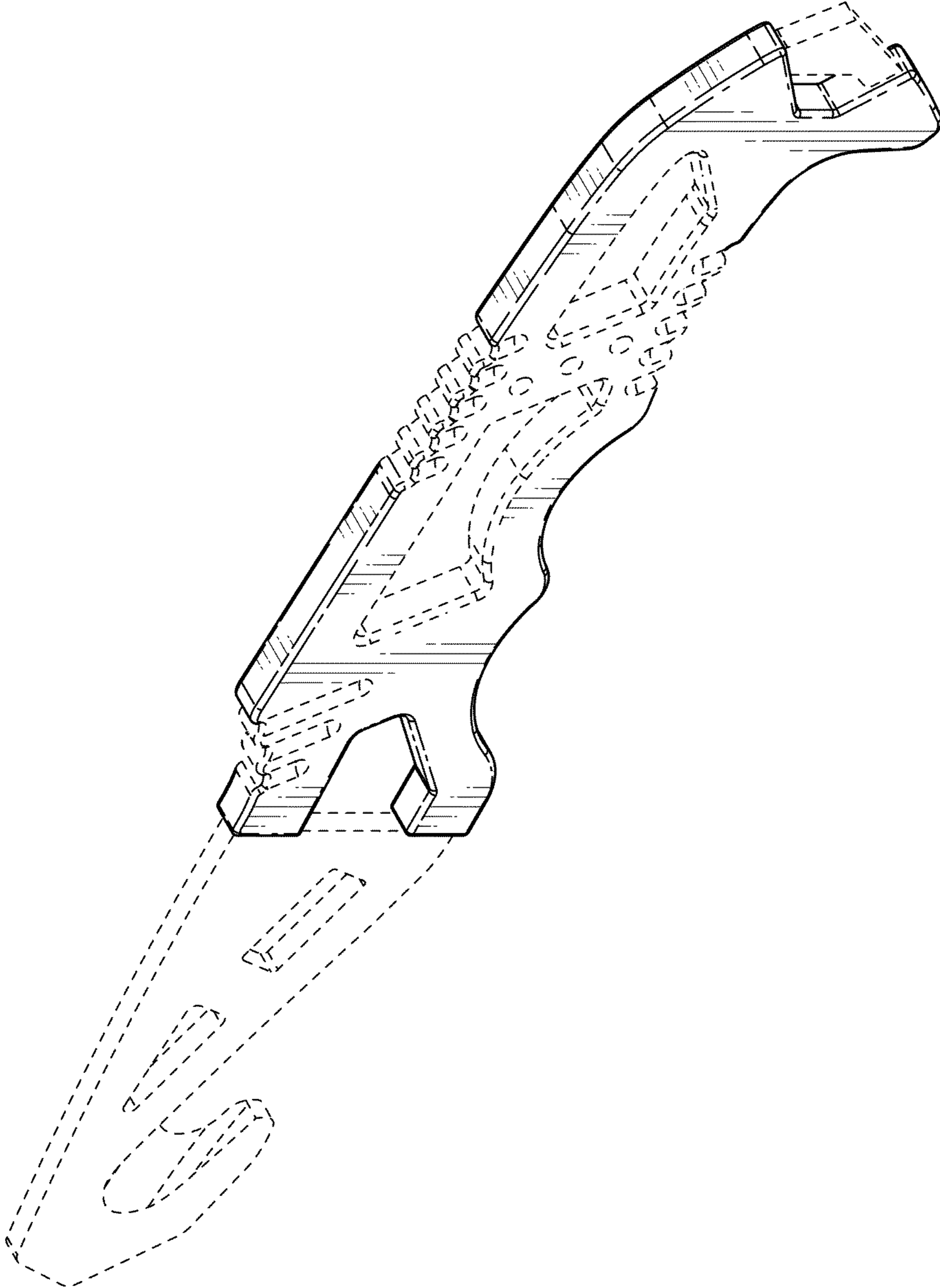

FIG. 9

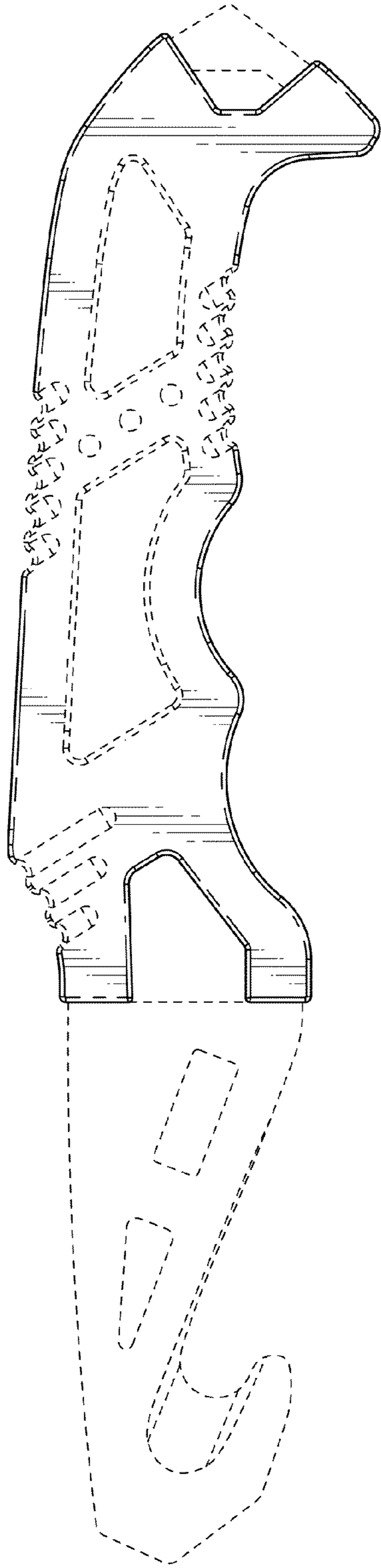

FIG. 10

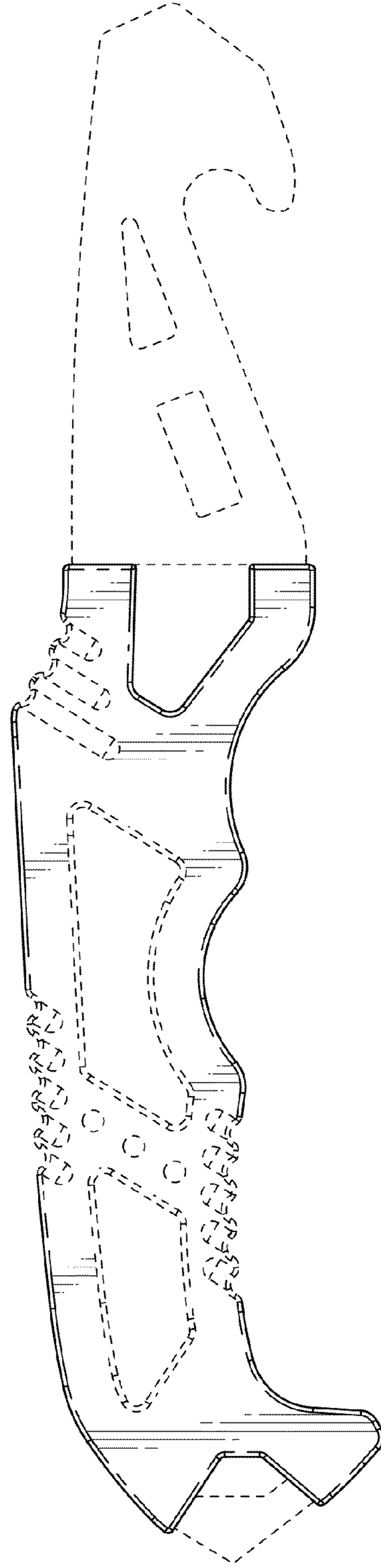

FIG. 11



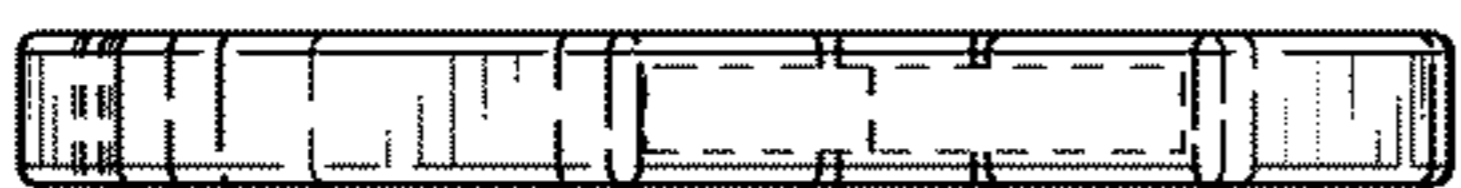

FIG. 12

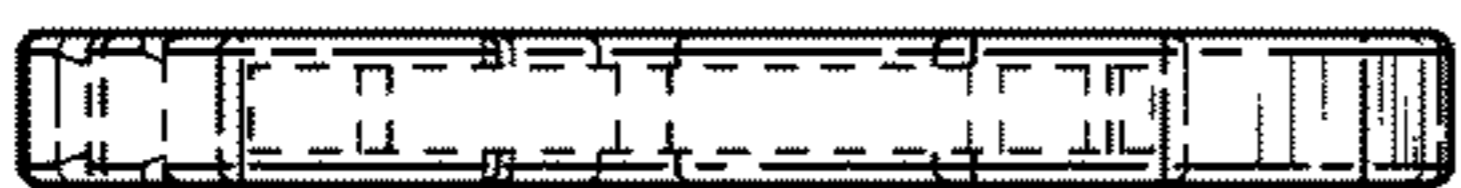

FIG. 13



FIG. 14



FIG. 15

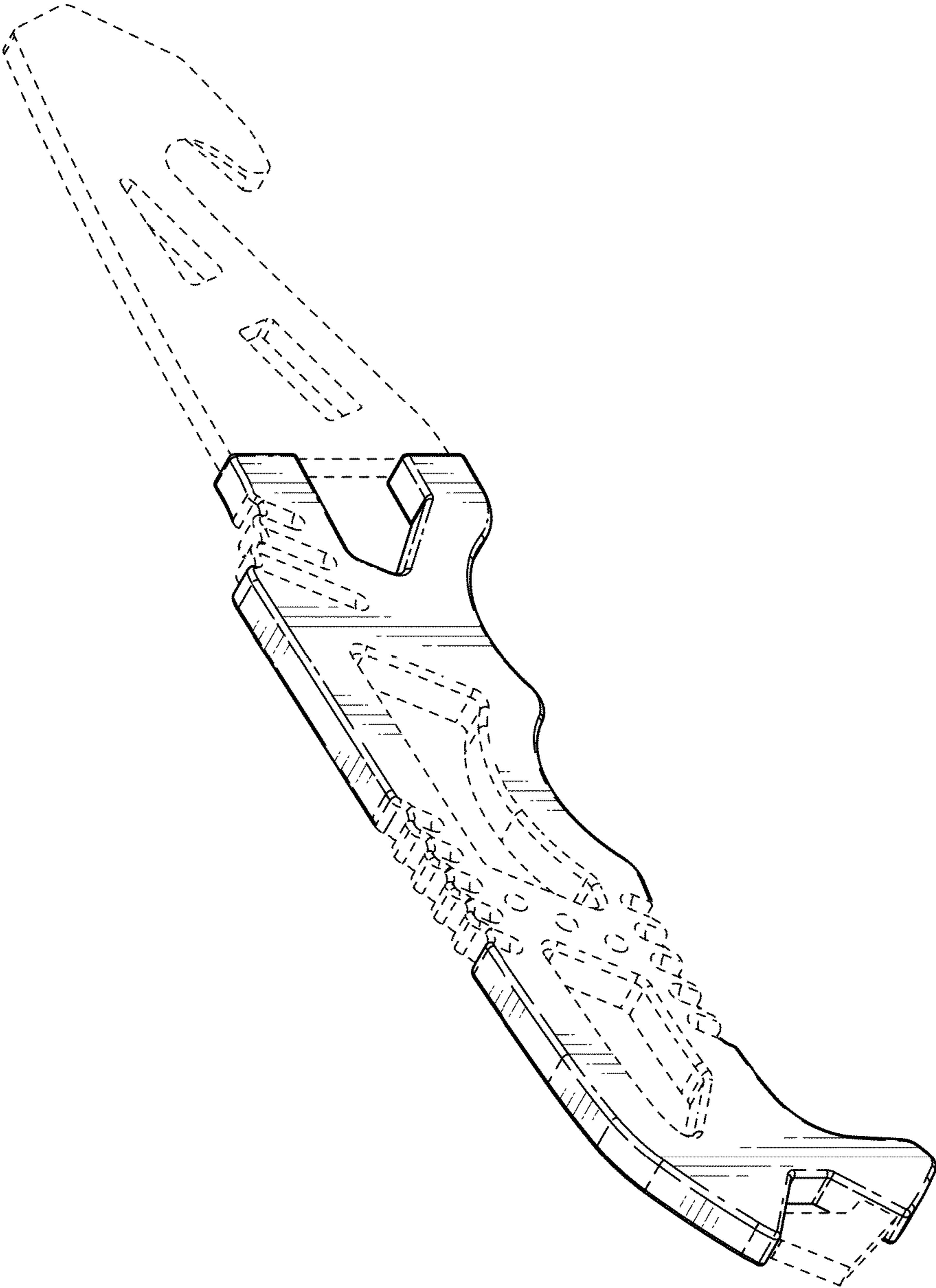

FIG. 16