



US00D700661S

(12) **United States Design Patent**
Mimlitch, III et al.

(10) **Patent No.:** **US D700,661 S**
(45) **Date of Patent:** **** *Mar. 4, 2014**

(54) **TOY FIGURE**

(71) Applicant: **Innovation First, Inc.**, Greenville, TX (US)
(72) Inventors: **Robert H. Mimlitch, III**, Rowlett, TX (US); **David A. Norman**, Greenville, TX (US); **Douglas Michael Galletti**, Allen, TX (US); **Jeffrey Russell Waegelin**, Rockwell, TX (US); **Gregory Needel**, Rockwell, TX (US); **Raul Olivera**, Greenville, TX (US)

(73) Assignee: **Innovation First, Inc.**, Greenville, TX (US)

(*) Notice: This patent is subject to a terminal disclaimer.

(**) Term: **14 Years**

(21) Appl. No.: **29/459,749**

(22) Filed: **Jul. 3, 2013**

Related U.S. Application Data

(62) Division of application No. 29/426,513, filed on Jul. 6, 2012.

(51) **LOC (10) Cl.** **21-01**

(52) **U.S. Cl.**
USPC **D21/578**; D21/650

(58) **Field of Classification Search**
USPC D21/447, 524, 533, 576-585, 650;
446/72, 97, 268-269, 321, 356,
446/376-377, 487

See application file for complete search history.

(56) **References Cited**

U.S. PATENT DOCUMENTS

D479,288 S	9/2003	Nakase
6,652,352 B1	11/2003	MacArthur et al.
6,866,557 B2	3/2005	Randall
D507,606 S	7/2005	Nakase
D555,213 S	11/2007	Bowen et al.
D583,882 S	12/2008	Domingues

Primary Examiner — Sandra Morris
(74) *Attorney, Agent, or Firm* — Adam K. Sacharoff

(57) **CLAIM**

The ornamental design for a toy figure, as shown and described.

DESCRIPTION

FIG. 1 is a front top perspective view showing a first embodiment of the toy figure;
FIG. 2 is a back top perspective view of FIG. 1;
FIG. 3 is a bottom left side perspective view of FIG. 1;
FIG. 4 is a bottom right side perspective view of FIG. 1;
FIG. 5 is a top side view of FIG. 1;
FIG. 6 is a bottom side view of FIG. 1;
FIG. 7 is a left side view of FIG. 1;
FIG. 8 is a right side view of FIG. 1;
FIG. 9 is a front side view of FIG. 1;
FIG. 10 is a back side view of FIG. 1;
FIG. 11 is a front top perspective view showing a second embodiment of the toy figure illustrating a top section of the toy figure;
FIG. 12 is a back top perspective view of FIG. 11;
FIG. 13 is a bottom left side perspective view of FIG. 11;
FIG. 14 is a bottom right side perspective view of FIG. 11;
FIG. 15 is a top side view of FIG. 11;
FIG. 16 is a bottom side view of FIG. 11;
FIG. 17 is a left side view of FIG. 11;
FIG. 18 is a right side view of FIG. 11;
FIG. 19 is a front side view of FIGS. 11; and,
FIG. 20 is a back side view of FIG. 11.

1 Claim, 20 Drawing Sheets

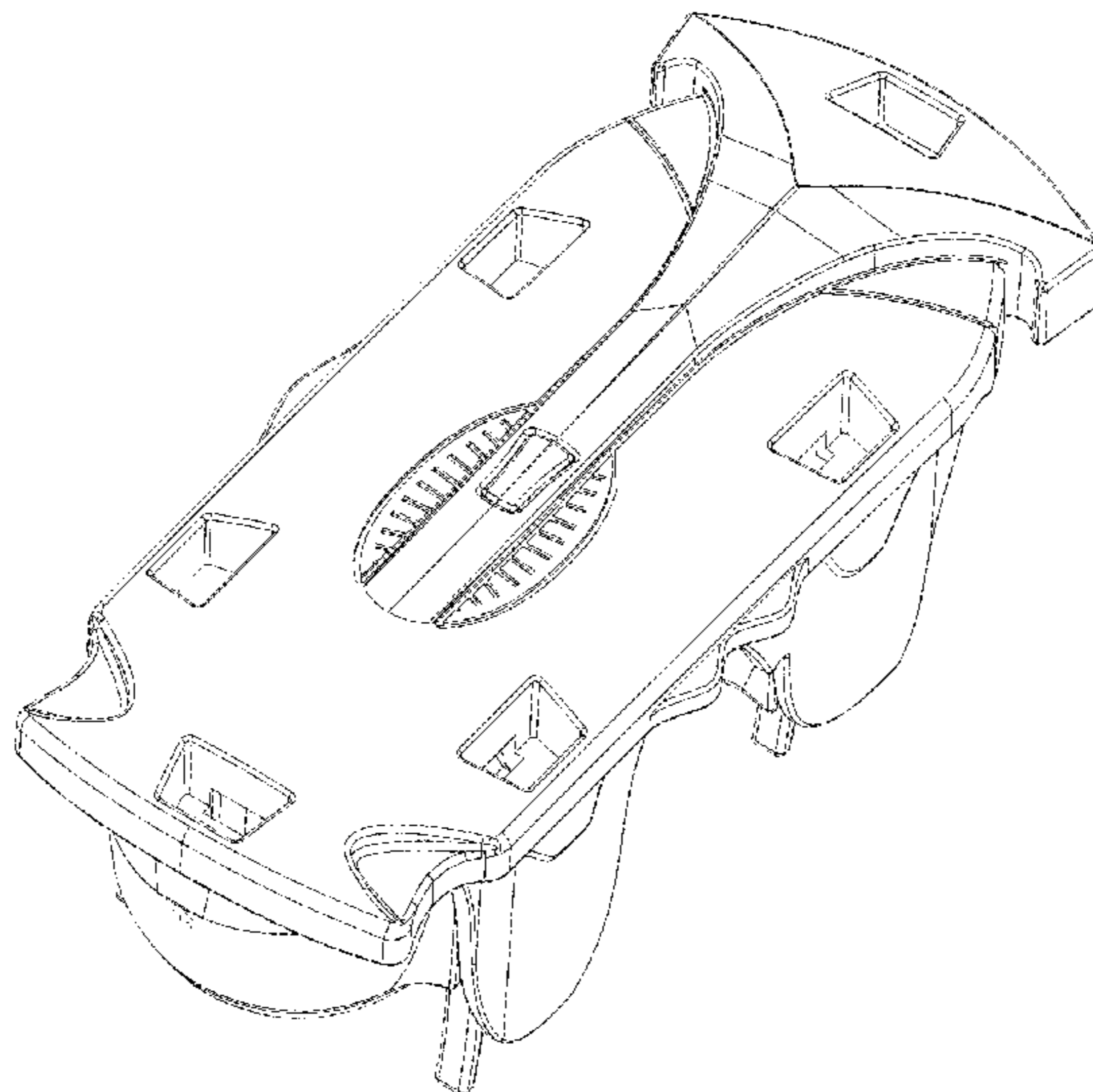

FIGURE 1

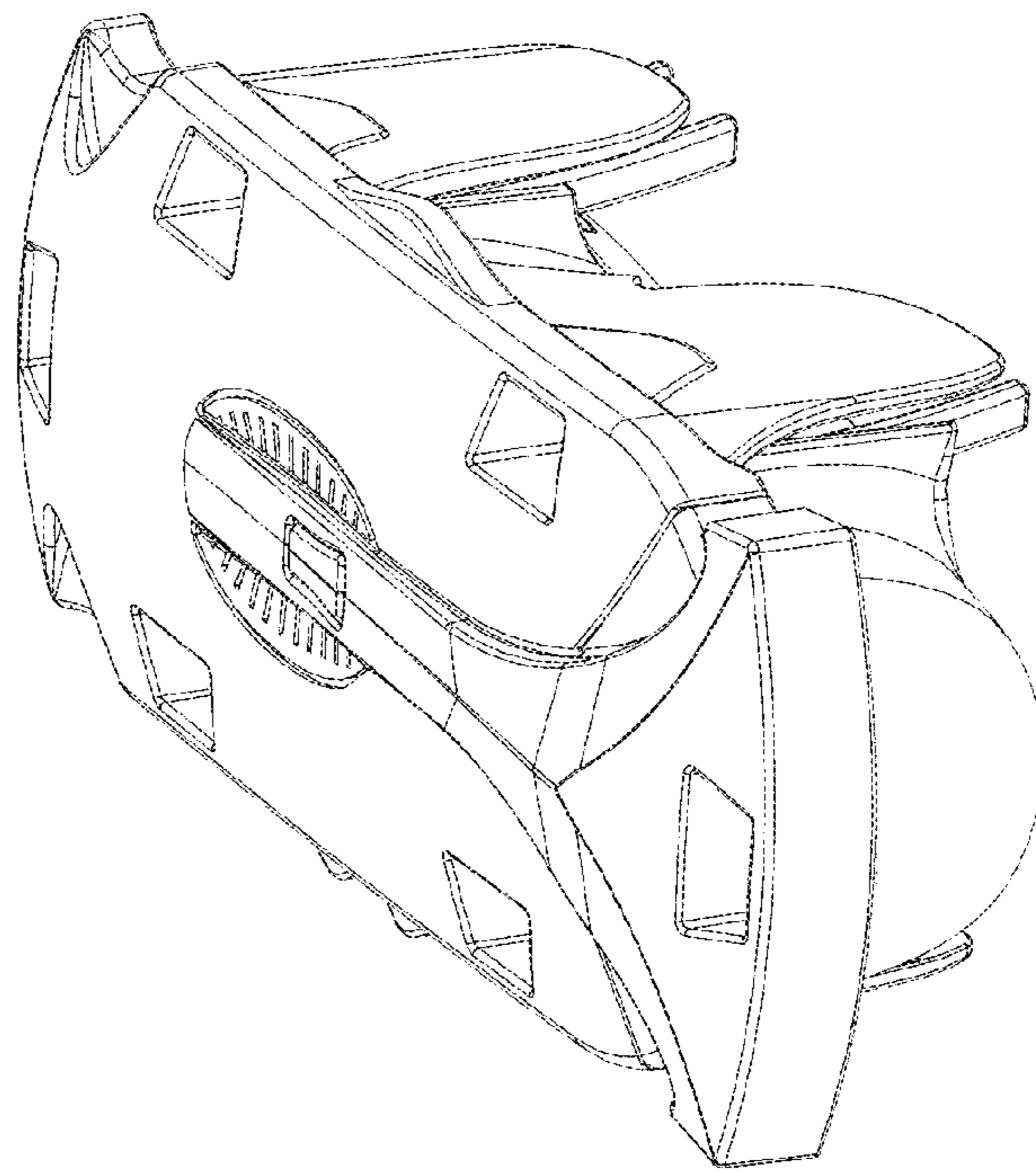

FIGURE 2

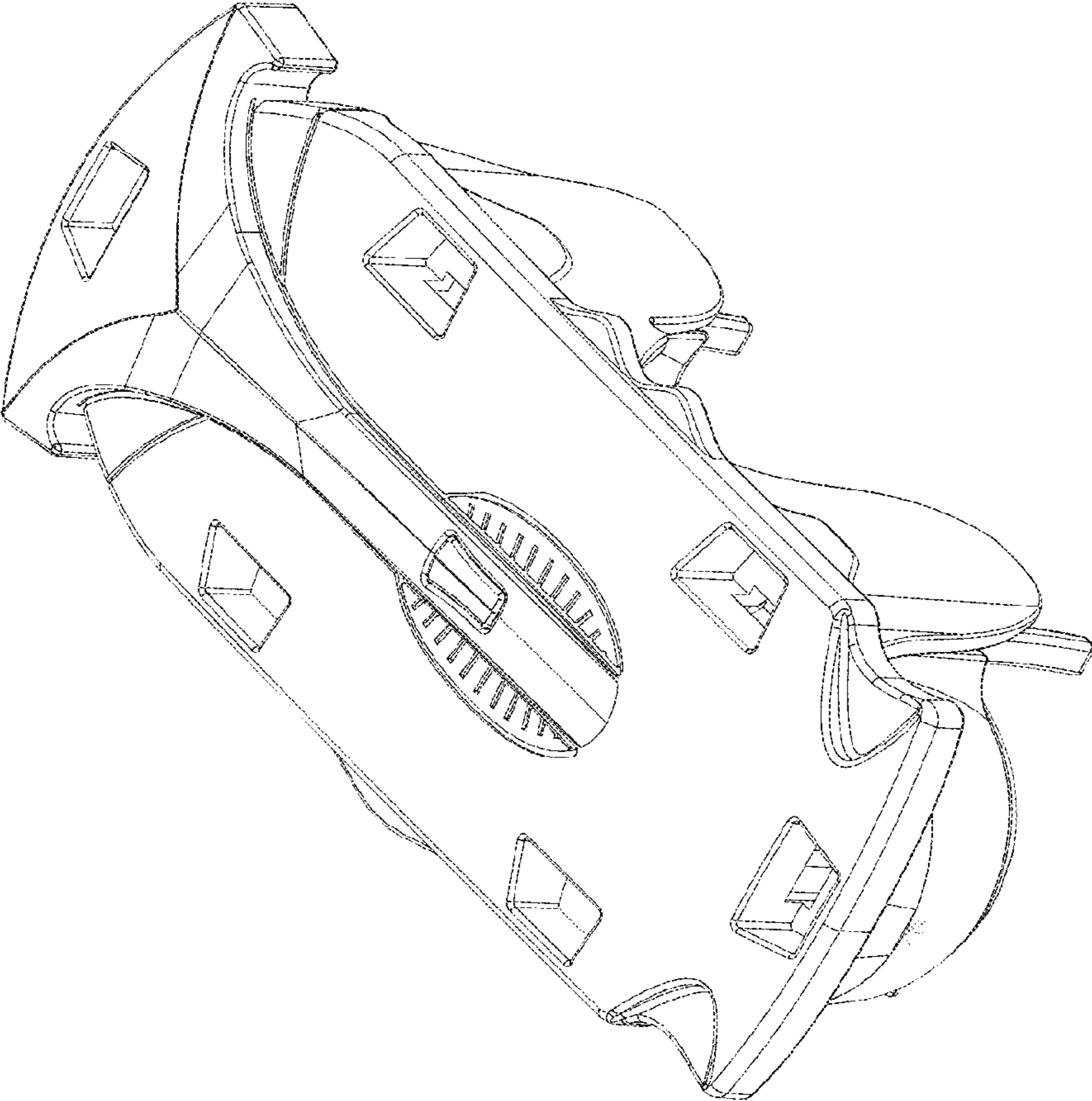

FIGURE 3

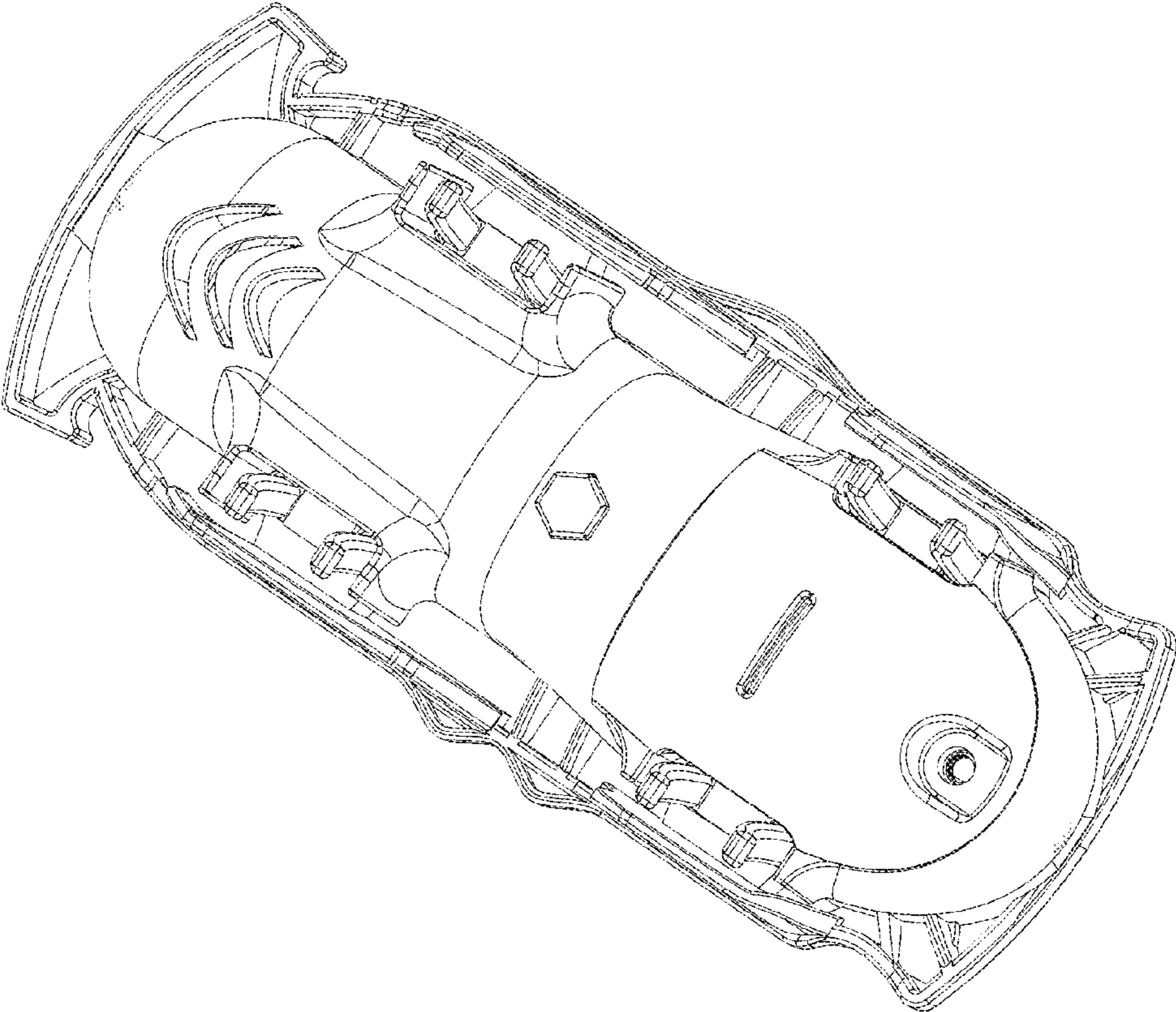

FIGURE 4

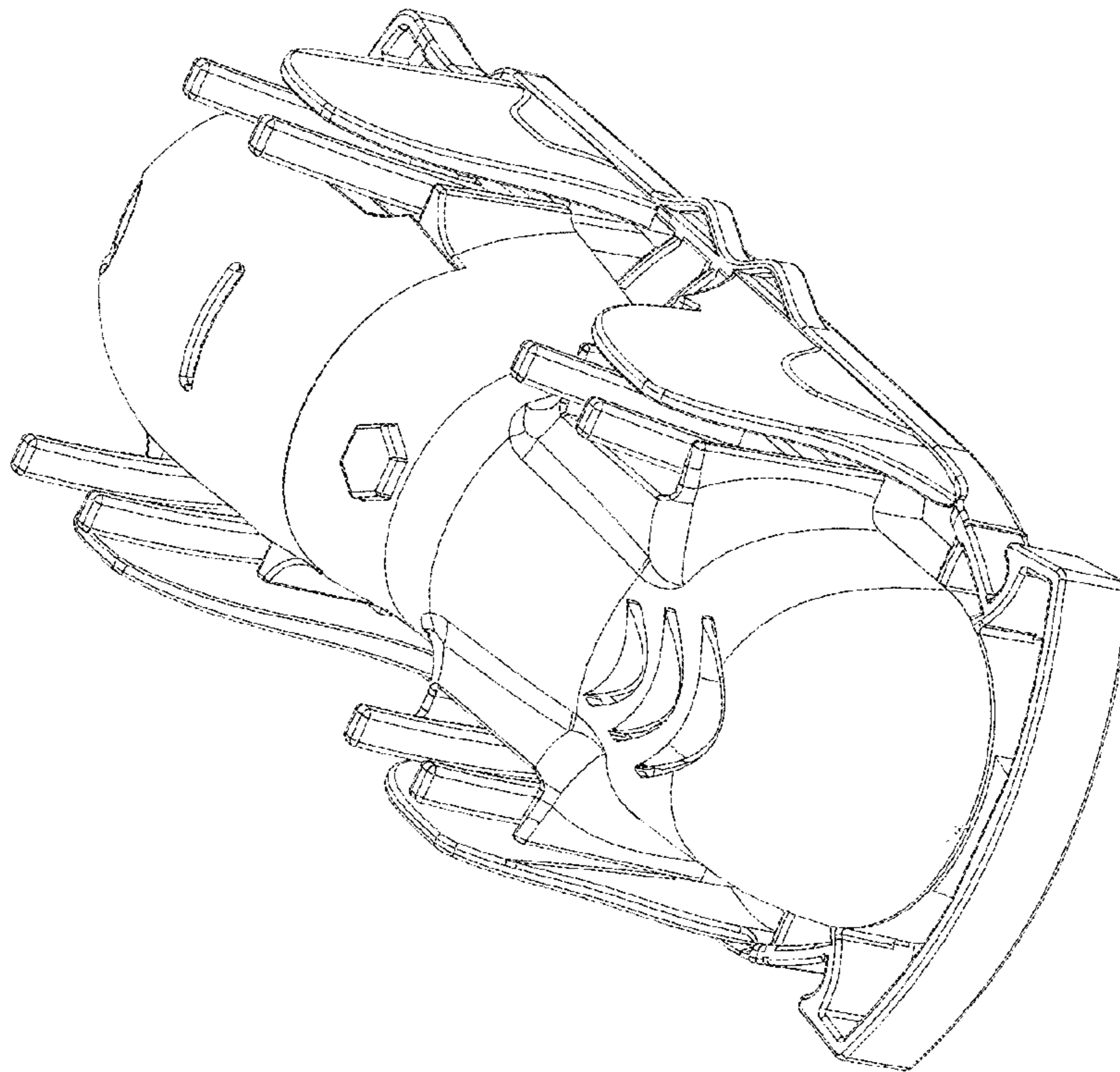

FIGURE 5

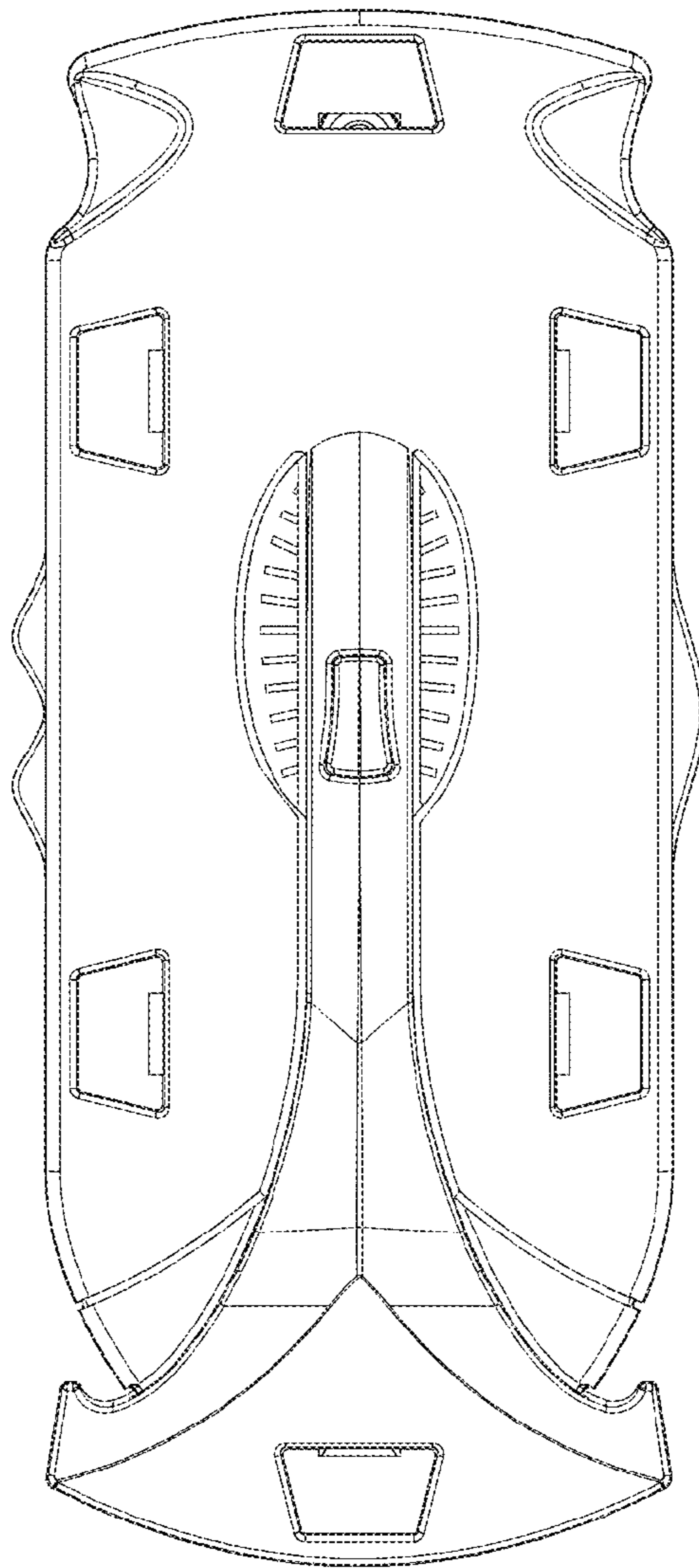

FIGURE 6

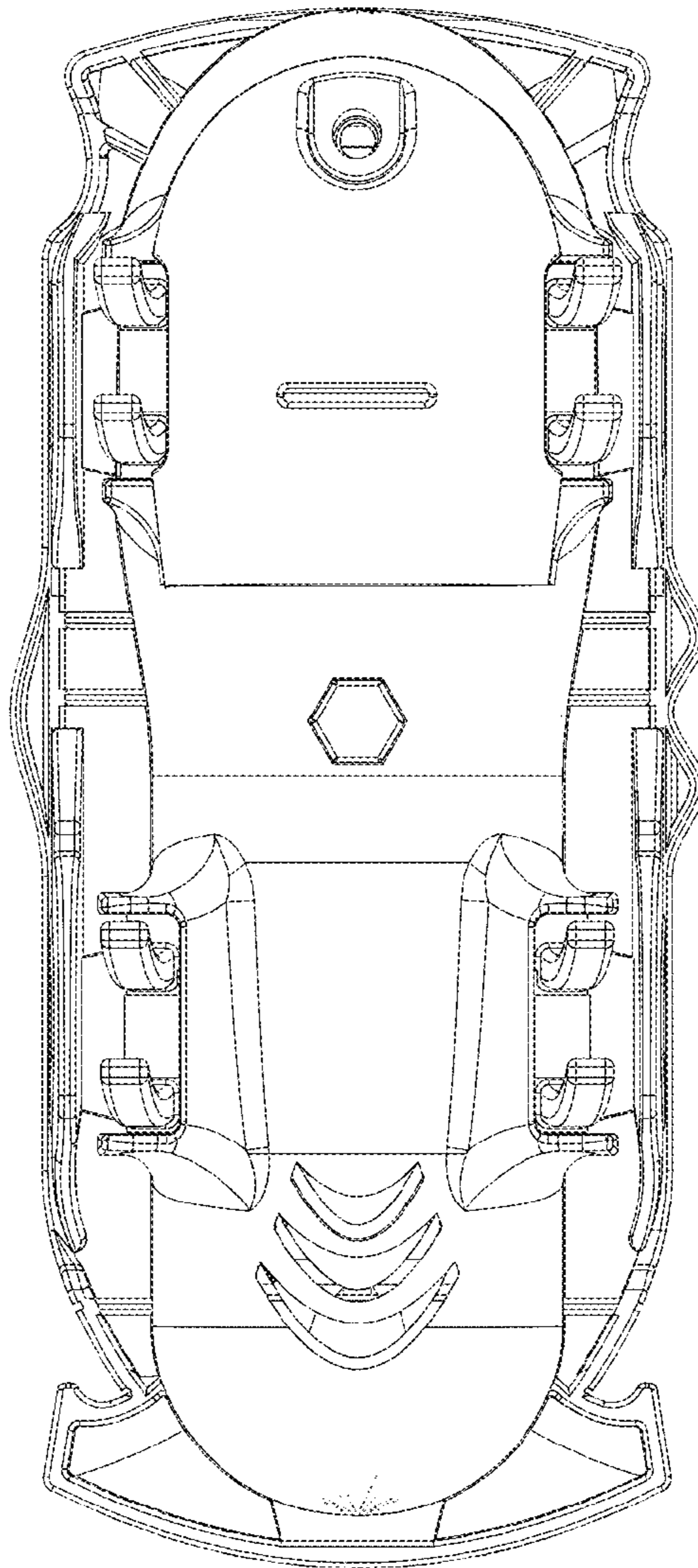

FIGURE 7

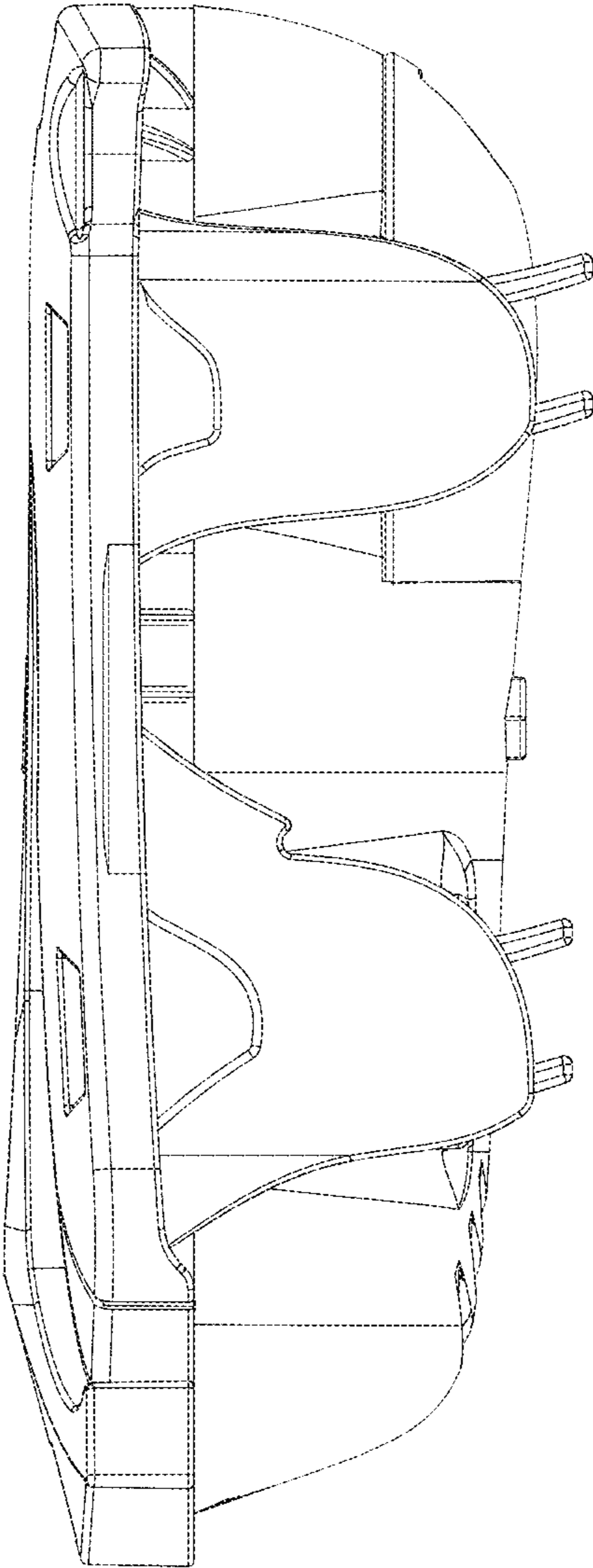

FIGURE 8

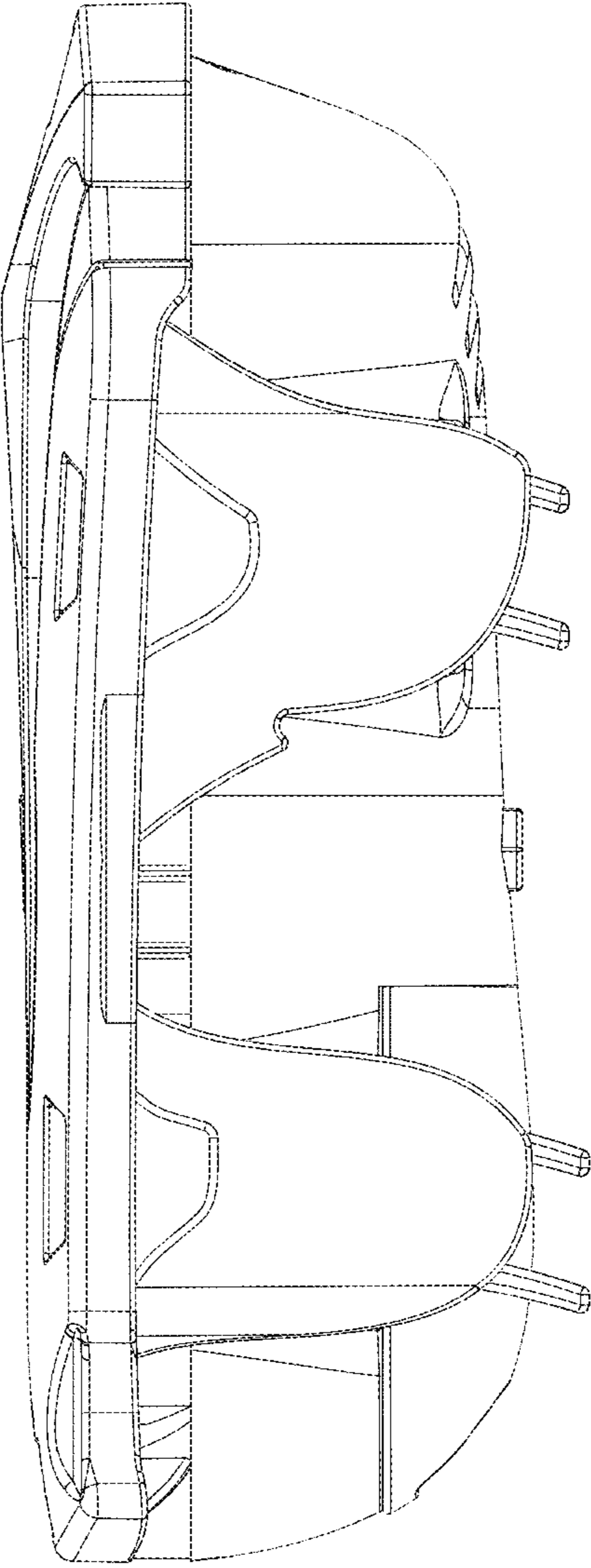

FIGURE 9

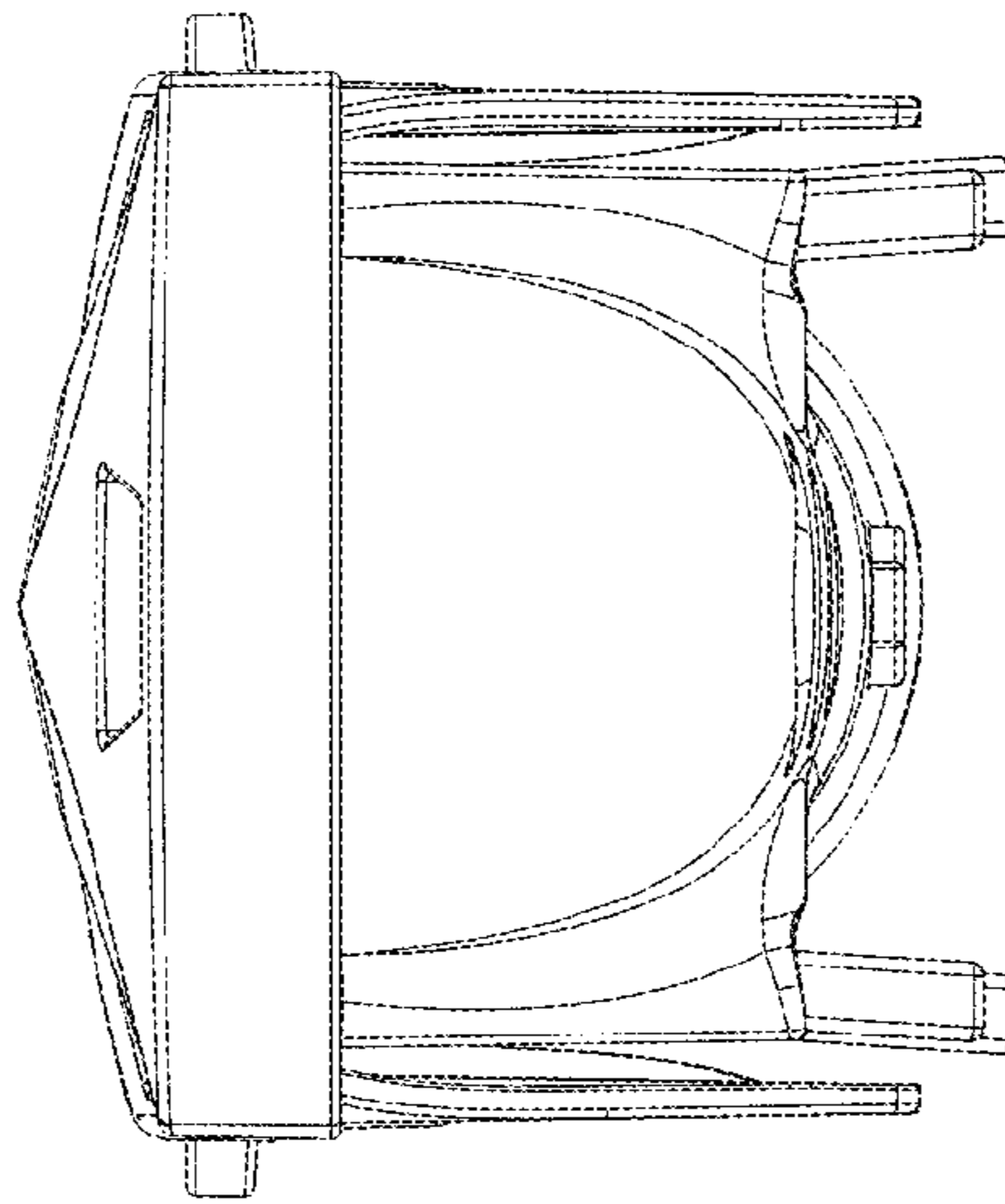

FIGURE 10

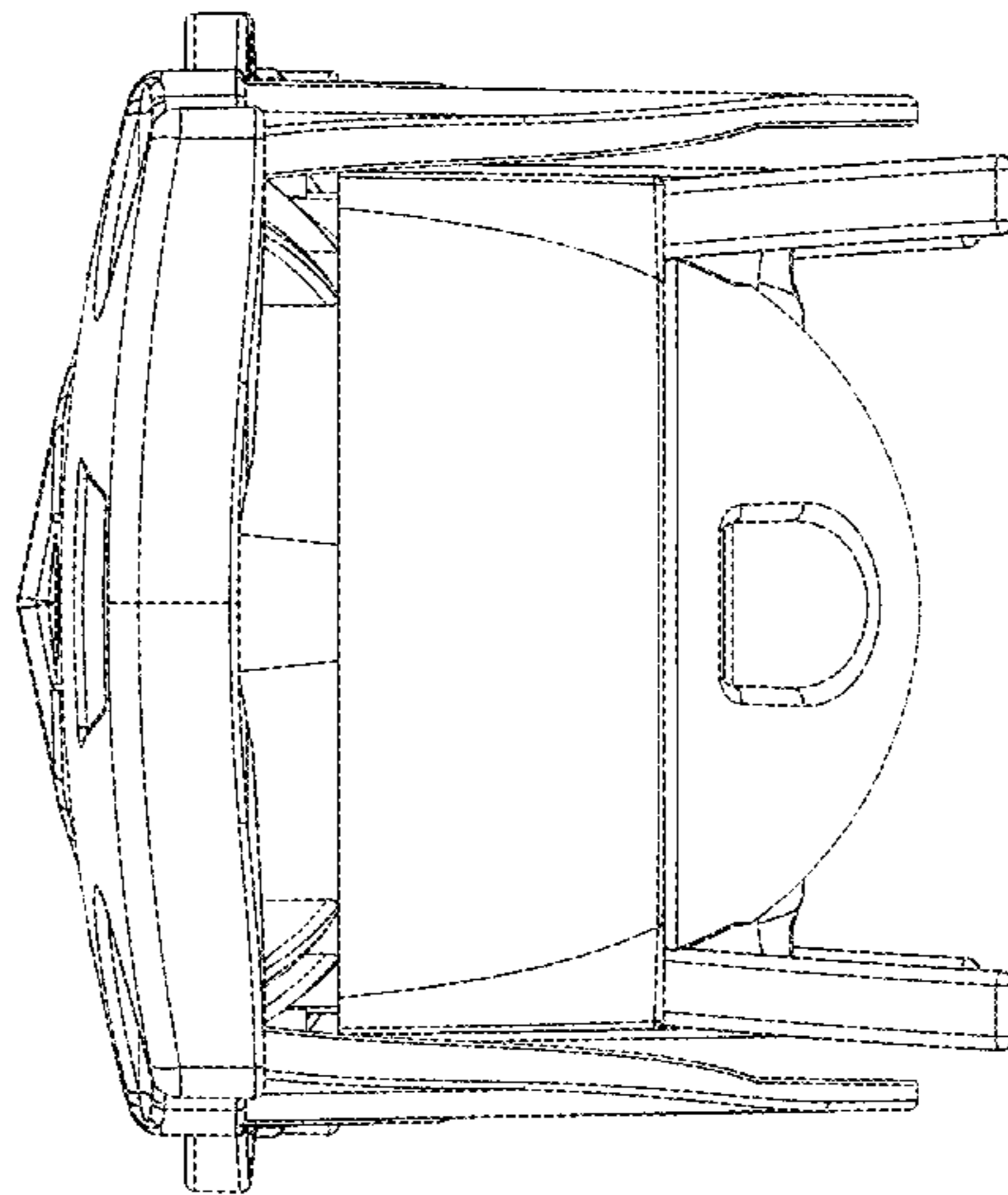

FIGURE 11

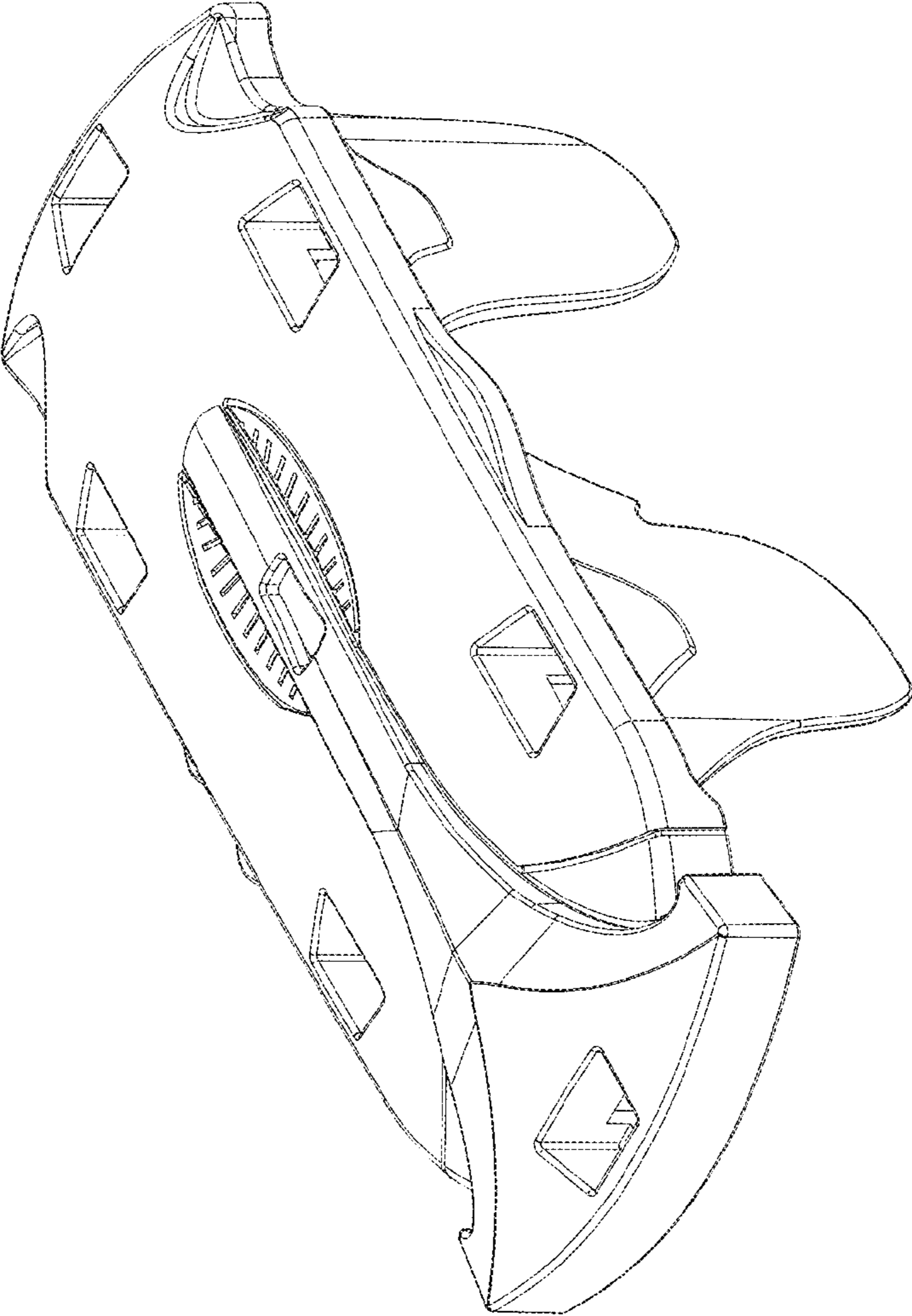

FIGURE 12

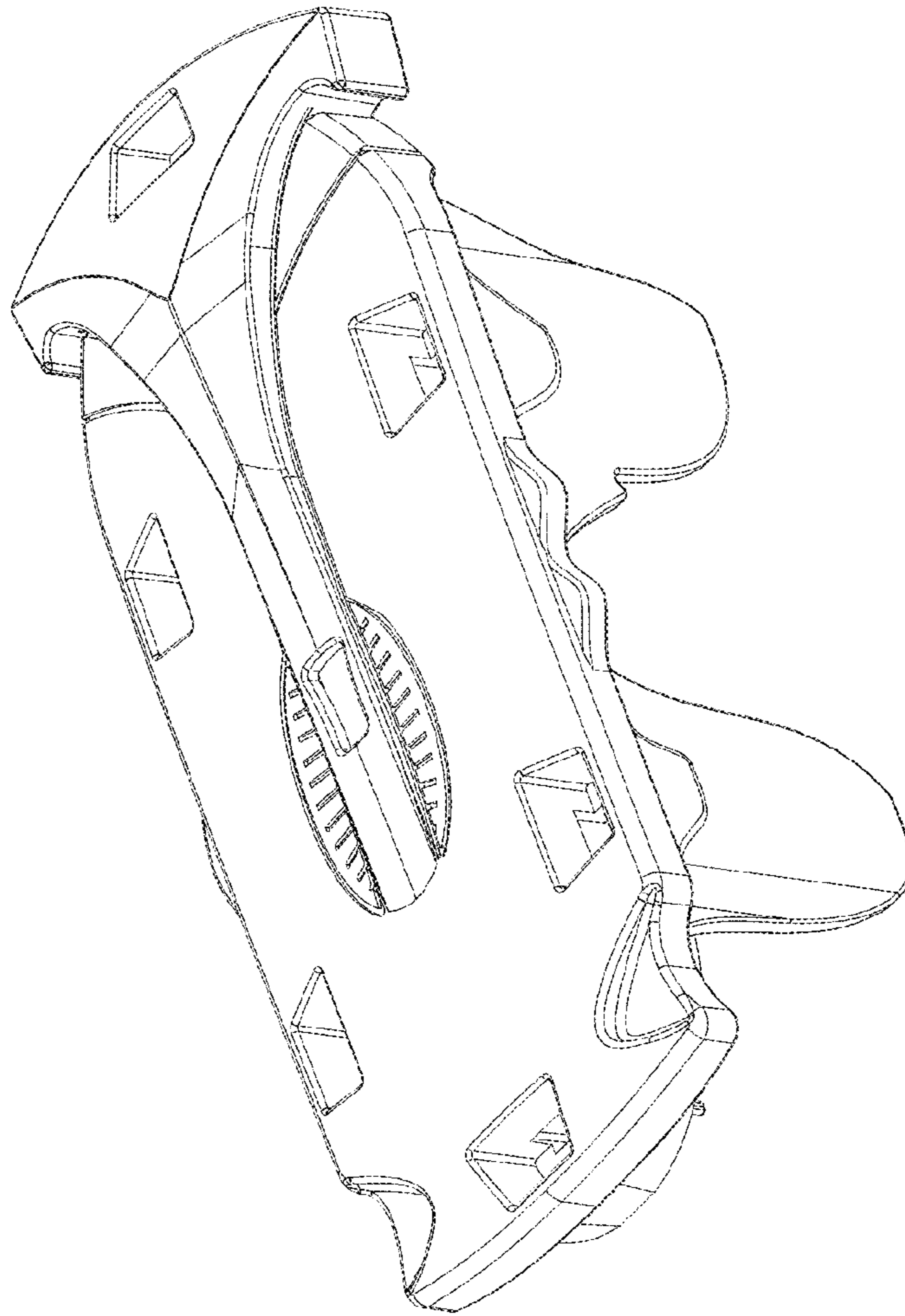

FIGURE 13

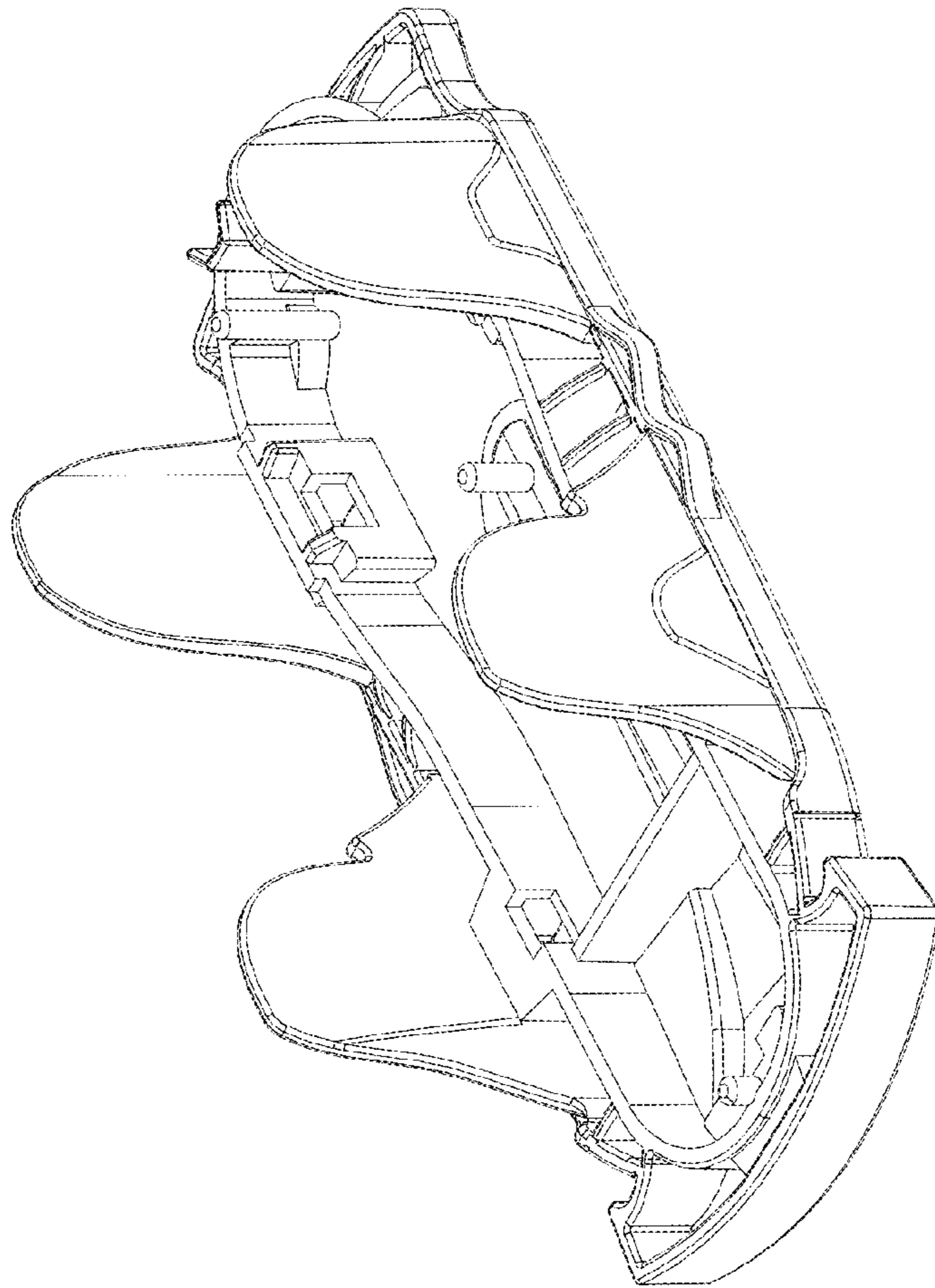

FIGURE 14

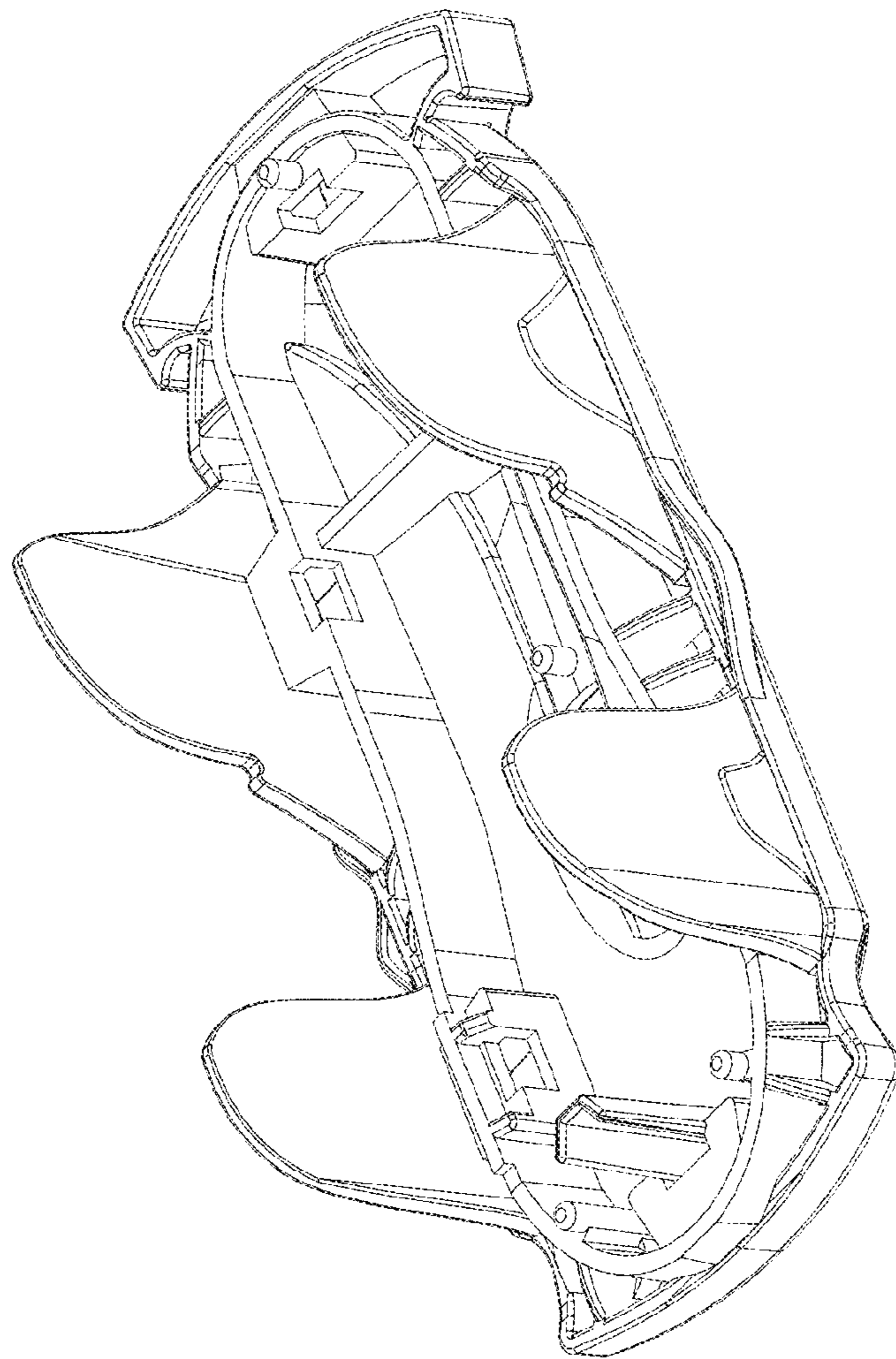

FIGURE 15

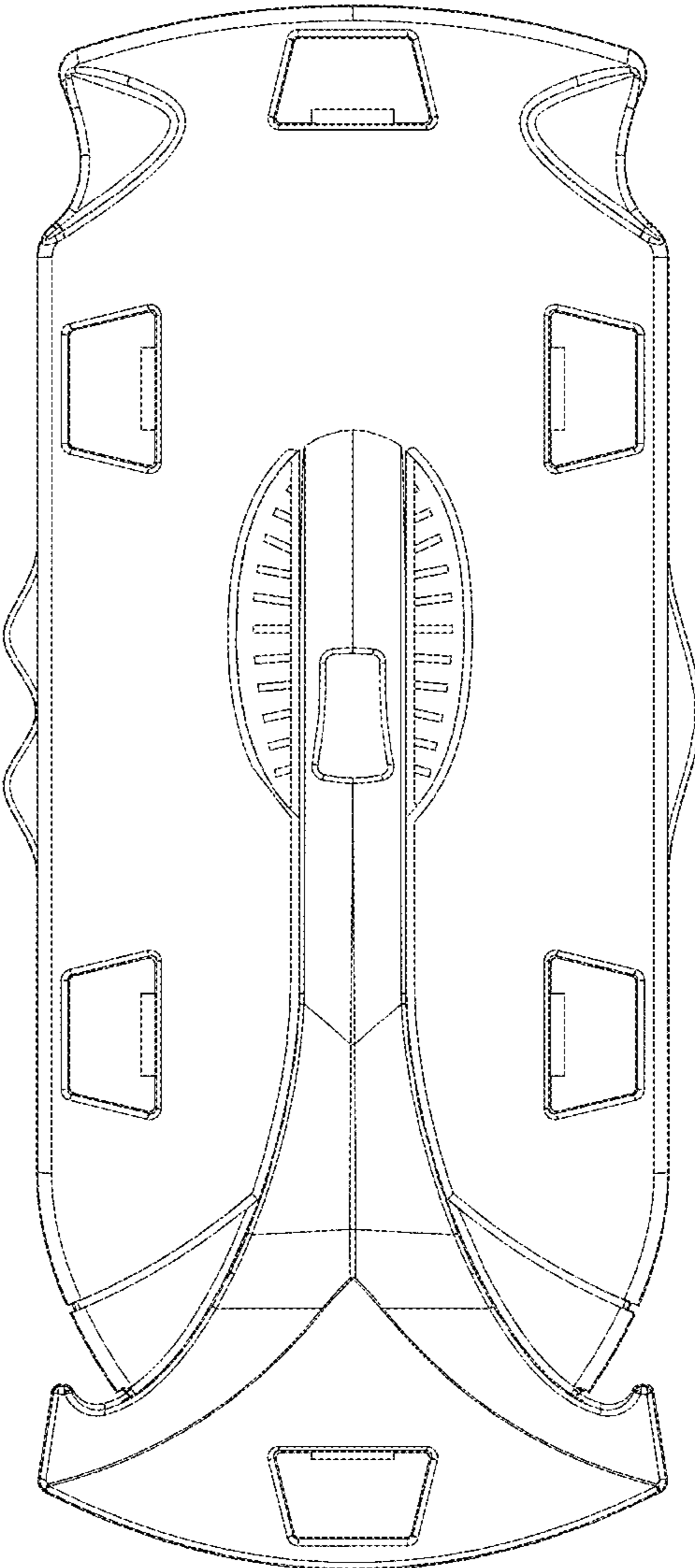

FIGURE 16

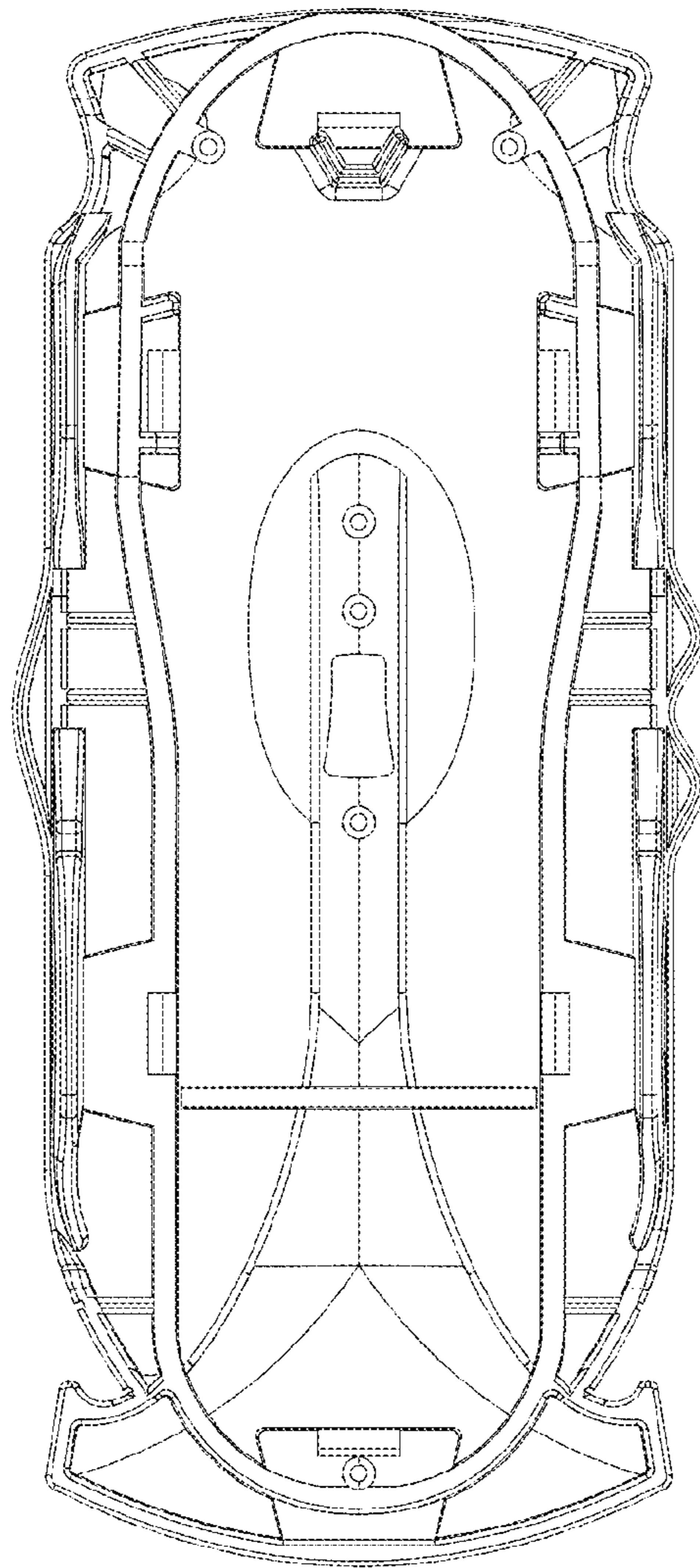

FIGURE 17

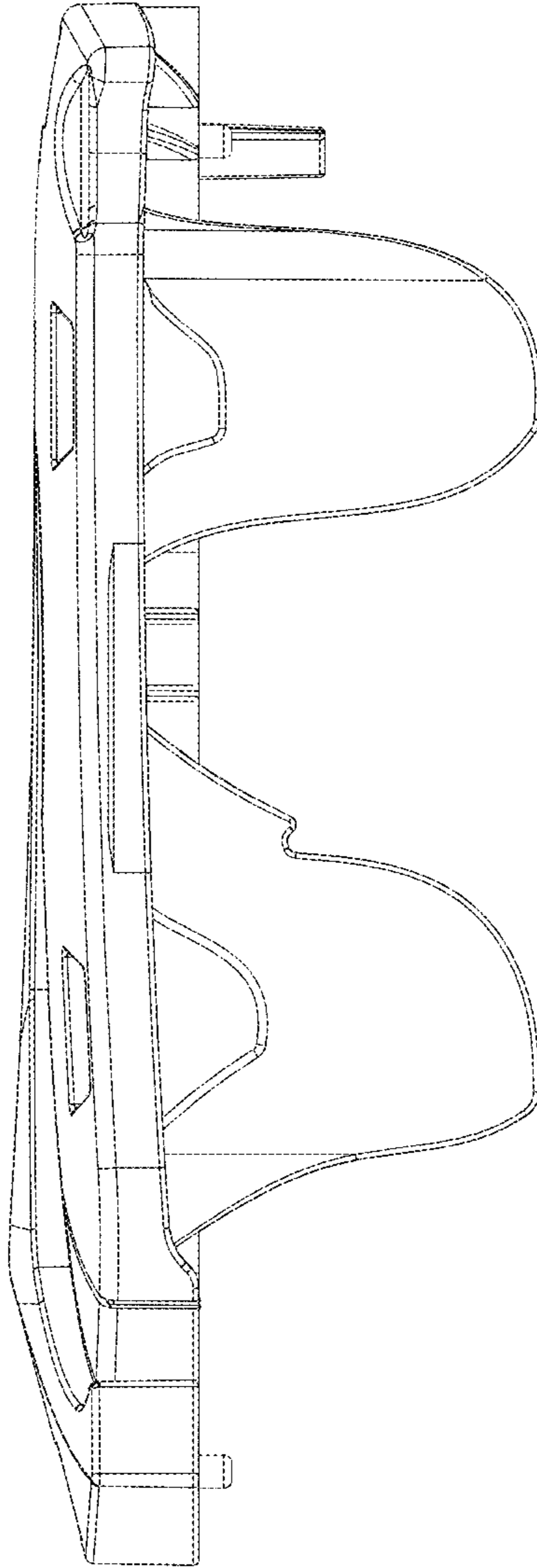

FIGURE 18

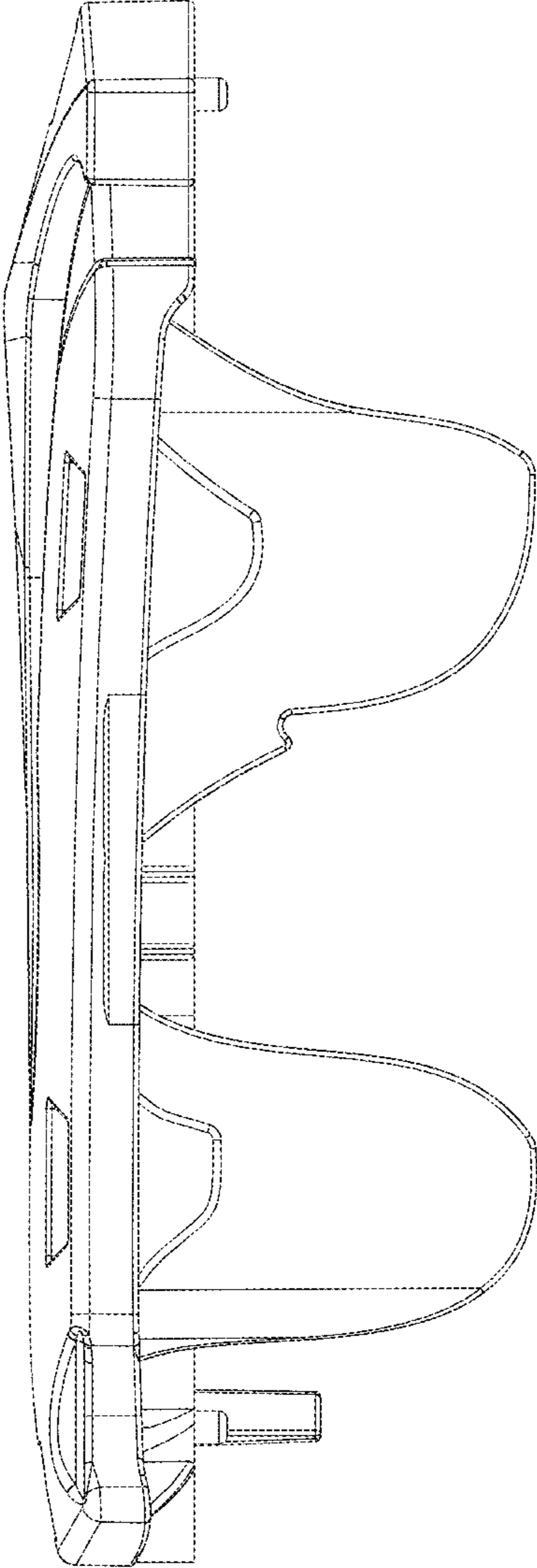

FIGURE 19

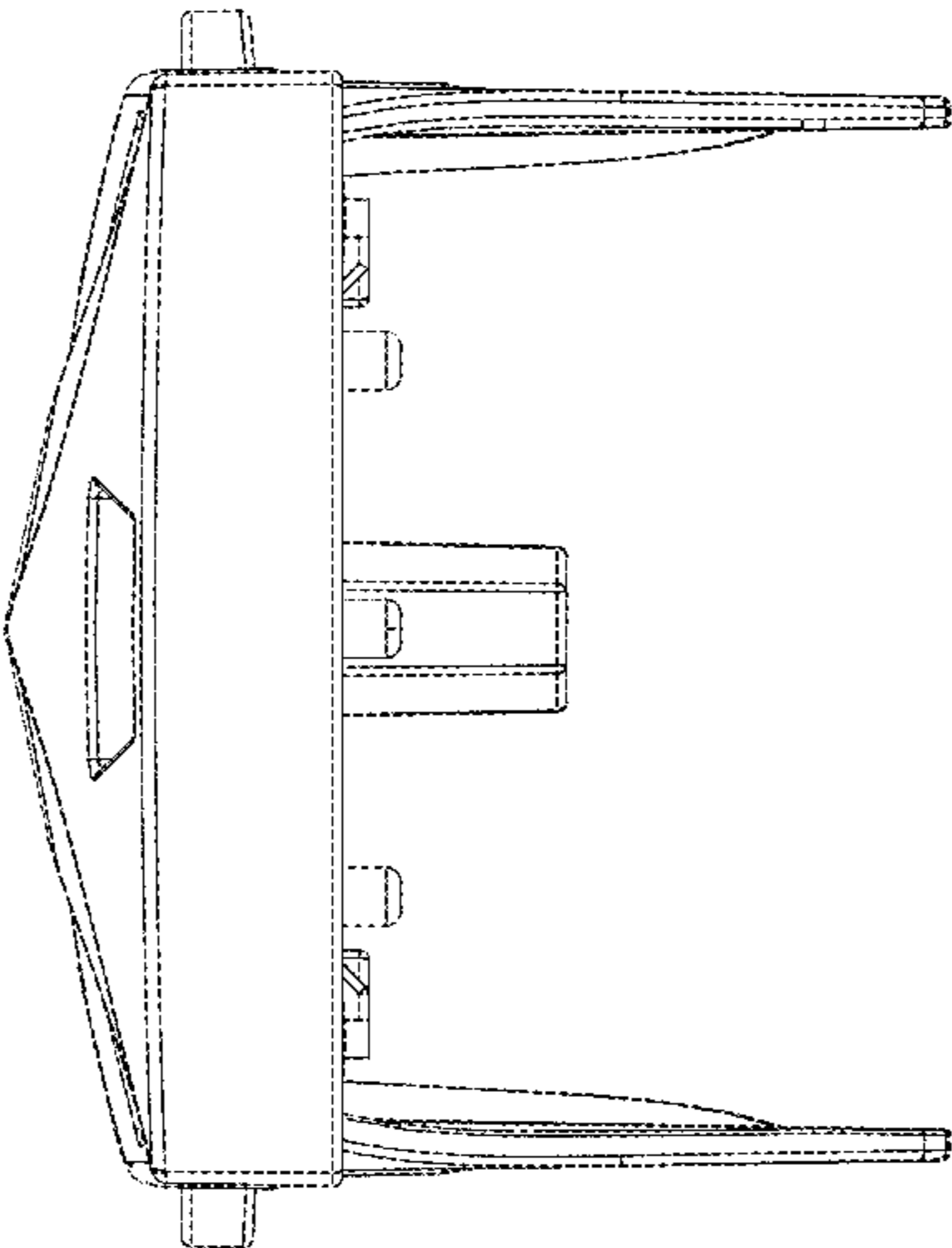

FIGURE 20

