



US00D700657S

(12) **United States Design Patent**  
**Schweig**

(10) **Patent No.:** **US D700,657 S**

(45) **Date of Patent:** **\*\* Mar. 4, 2014**

(54) **WRITING IMPLEMENT**

(75) Inventor: **Ulrich Schweig**, Hamburg (DE)

(73) Assignee: **J.S. Staedtler GmbH & Co. KG**,  
Nürnberg (DE)

(\*\*) Term: **14 Years**

(21) Appl. No.: **29/429,585**

(22) Filed: **Aug. 14, 2012**

(30) **Foreign Application Priority Data**

Feb. 14, 2012 (EM) ..... 001 991 183

(51) **LOC (10) Cl.** ..... **19-06**

(52) **U.S. Cl.**  
USPC ..... **D19/174**

(58) **Field of Classification Search**  
USPC ..... D14/411; D19/35, 36, 41-51, 53-58;  
24/11 F, 11 R, 11 P; 402/52, 99-109,  
402/192, 195, 196  
See application file for complete search history.

(56) **References Cited**

**U.S. PATENT DOCUMENTS**

2,637,906 A \* 5/1953 Giossi ..... 33/27.02  
D177,560 S \* 5/1956 Ensign et al. .... D19/49

5,313,557 A \* 5/1994 Osterhout ..... 704/272  
D393,485 S \* 4/1998 Bussiere et al. .... D19/51  
D439,612 S \* 3/2001 Jones ..... D19/36  
D445,454 S \* 7/2001 Martens et al. .... D19/51  
D471,589 S \* 3/2003 Pellissa Beneyto ..... D19/51  
D500,521 S \* 1/2005 Hautzinger et al. .... D19/51  
D501,506 S \* 2/2005 Kommer ..... D19/51  
6,923,588 B1 \* 8/2005 Hsieh ..... 401/115  
D575,823 S \* 8/2008 Rommel ..... D19/51  
D600,281 S \* 9/2009 Delancourt ..... D19/48  
D611,094 S \* 3/2010 Collin ..... D19/41

\* cited by examiner

*Primary Examiner* — Elizabeth Albert

(74) *Attorney, Agent, or Firm* — Lucas & Mercanti, LLP;  
Klaus P. Stoffel

(57) **CLAIM**

The ornamental design for a writing implement, as shown and described.

**DESCRIPTION**

FIG. 1 is a perspective view of the writing implement of the present invention;  
FIG. 2 is a front view thereof;  
FIG. 3 is a side view thereof;  
FIG. 4 is another side view thereof;  
FIG. 5 is rear view thereof;  
FIG. 6 is a top view thereof; and,  
FIG. 7 is a bottom view thereof.

**1 Claim, 4 Drawing Sheets**

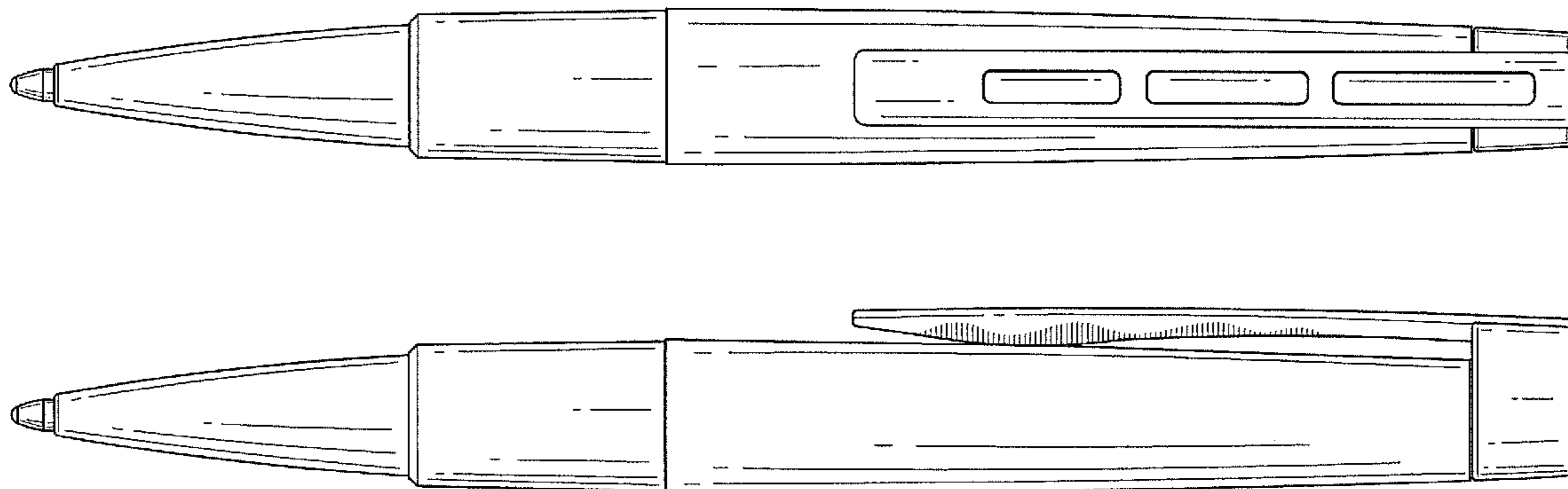

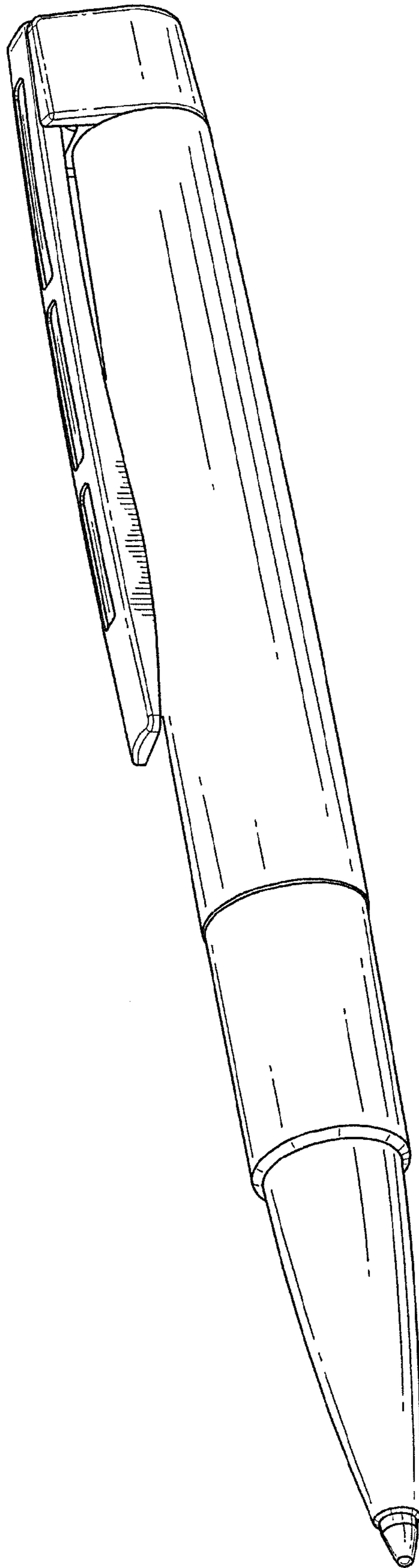

FIG. 1

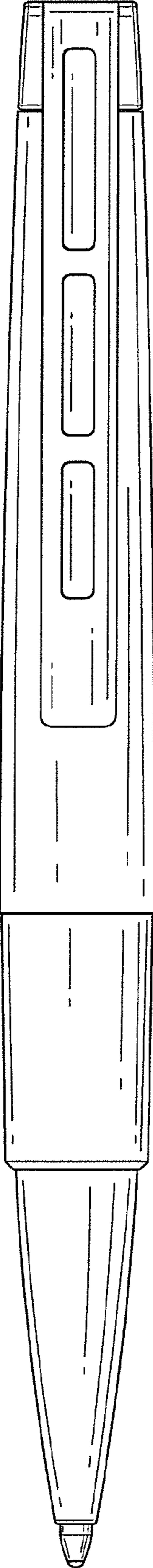

FIG. 2

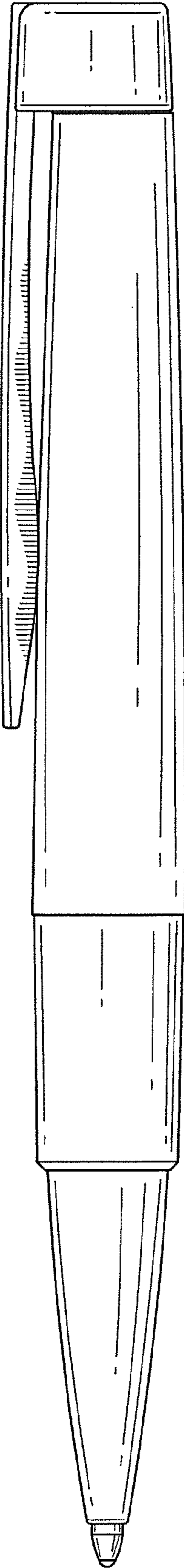

FIG. 3

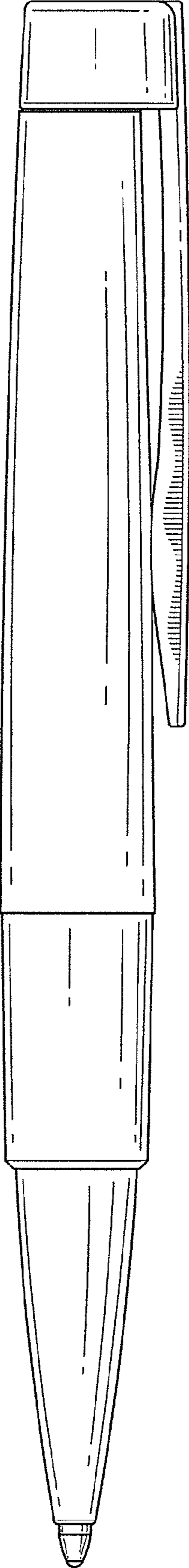

FIG. 4

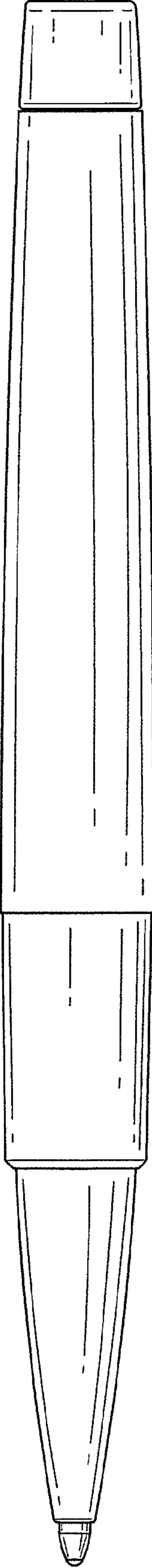

FIG. 5

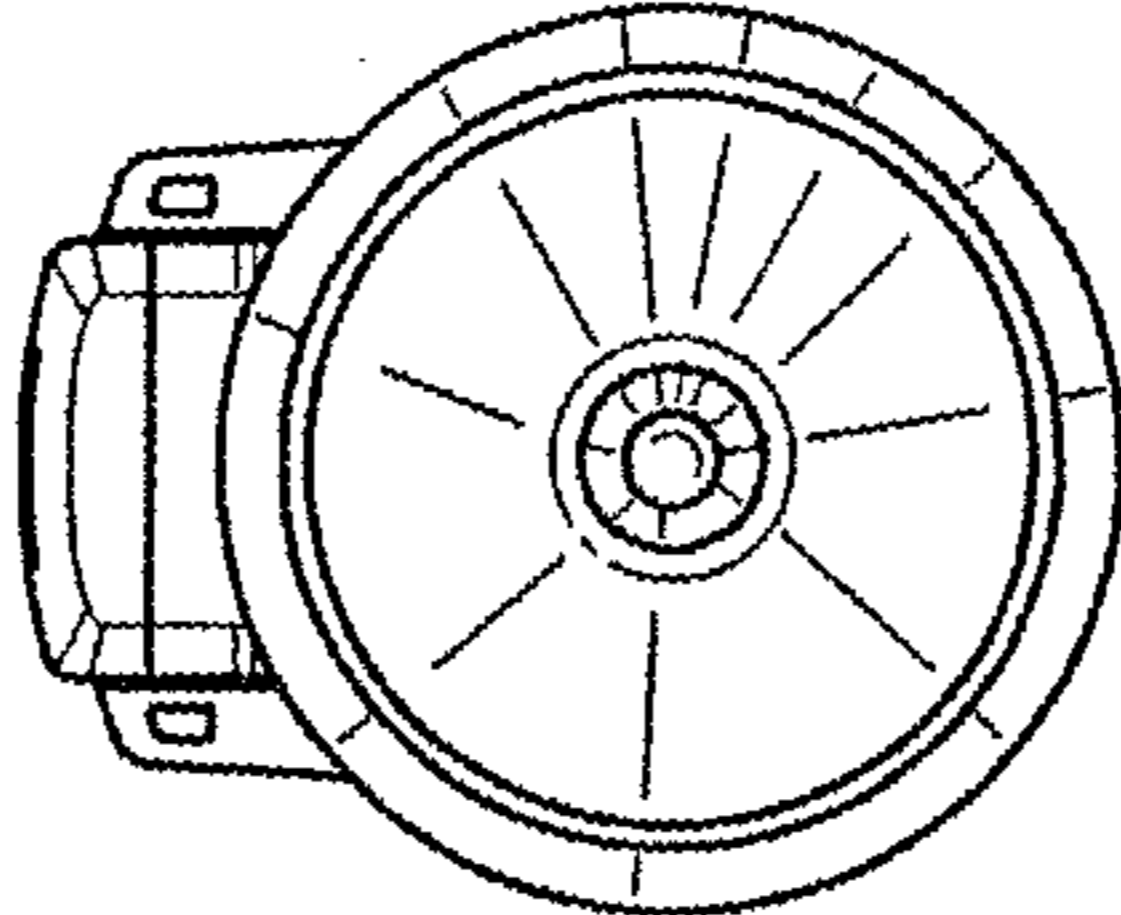

FIG. 7

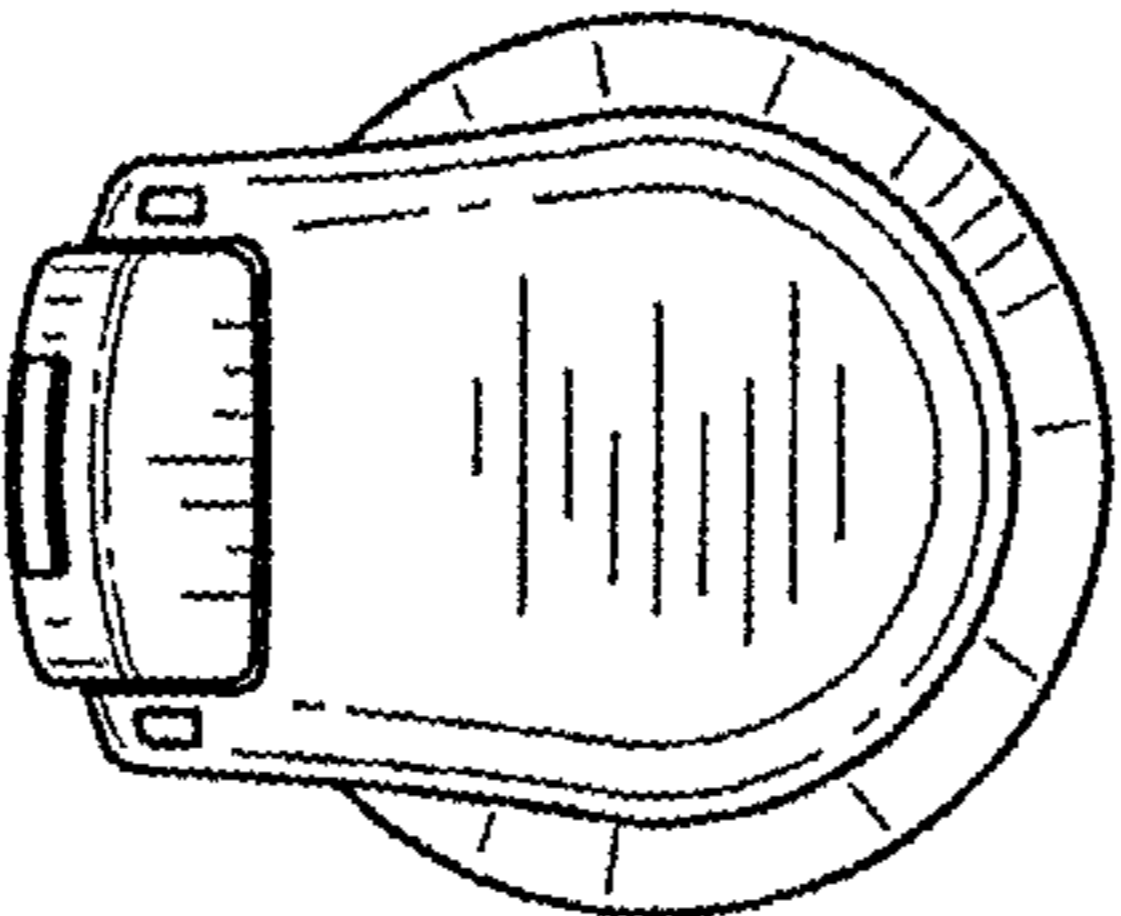

FIG. 6