



US00D700648S

(12) **United States Design Patent**
Siracusa

(10) **Patent No.:** **US D700,648 S**
(45) **Date of Patent:** **** Mar. 4, 2014**

(54) **EYEGLASSES WITH INTERCHANGEABLE
TEMPLES AND A RETENTION STRAP**

(71) Applicant: **Dean Siracusa**, Austin, TX (US)

(72) Inventor: **Dean Siracusa**, Austin, TX (US)

(**) Term: **14 Years**

(21) Appl. No.: **29/466,706**

(22) Filed: **Sep. 10, 2013**

(51) **LOC (10) Cl.** **16-06**

(52) **U.S. Cl.**
USPC **D16/311**; D16/326

(58) **Field of Classification Search**
USPC D16/101, 300–342, 900; D29/109–110;
351/41, 44, 51–52, 62, 158, 92,
351/103–123, 140–153, 45–46; 2/426–432,
2/447–449, 441, 434–437, 13, 15;
D21/483, 659–661; D14/372

See application file for complete search history.

(56) **References Cited**

U.S. PATENT DOCUMENTS

4,068,918	A *	1/1978	Holcombe, Jr.	359/358
D367,491	S *	2/1996	Warner	D16/311
D434,061	S *	11/2000	Chiang	D16/311
D466,543	S *	12/2002	Beames	D16/311
6,749,299	B1 *	6/2004	Hsu	351/62
D535,681	S *	1/2007	Yang	D16/311
D536,361	S *	2/2007	Sheldon et al.	D16/311
D561,810	S *	2/2008	Fox et al.	D16/325
D591,789	S *	5/2009	Li	D16/326
D615,582	S *	5/2010	Fulton et al.	D16/326
D622,301	S *	8/2010	Fulton	D16/311
D634,771	S *	3/2011	Fuchs	D16/311
D638,876	S *	5/2011	Sheldon	D16/326
D646,706	S *	10/2011	Wang	D16/309
D675,667	S *	2/2013	Shin	D16/326
D683,387	S *	5/2013	Sheldon	D16/311

D687,086	S *	7/2013	Sheldon	D16/326
D689,116	S *	9/2013	Chen	D16/311
2005/0088613	A1 *	4/2005	Jackson et al.	351/154

* cited by examiner

Primary Examiner — Raphael Barkai

(74) *Attorney, Agent, or Firm* — QuickPatents; Kevin Prince

(57) **CLAIM**

I claim the ornamental design for an eyeglasses with interchangeable temples and a retention strap, as shown and described.

DESCRIPTION

FIG. 1 is an exploded perspective view of an eyeglasses with interchangeable temples and a retention strap, showing my new design with the temples omitted for clarity of illustration; FIG. 2 is a top perspective view thereof, illustrated with the strap omitted for clarity of illustration and with the temples in an extended configuration; FIG. 3 is a front elevational view of FIG. 2; FIG. 4 is a rear elevational view of FIG. 2; FIG. 5 is a right-side elevational view of FIG. 2, the left-side elevational view being a mirror image thereof; FIG. 6 is a bottom plan view of FIG. 2; FIG. 7 is a top plan view of FIG. 2; FIG. 8 is a rear perspective view of FIG. 2 but with the temples in a collapsed configuration; FIG. 9 is a rear perspective view of FIG. 1; FIG. 10 is a front elevational view of FIG. 9; FIG. 11 is a rear elevational view of FIG. 9; FIG. 12 is a left-side elevational view of FIG. 9; FIG. 13 is a right-side elevational view of FIG. 9; FIG. 14 is a bottom plan view of FIG. 9; and, FIG. 15 is a top plan view of FIG. 9.

The broken lines shown in FIGS. 1, 5, 12 and 13 are for illustrative purposes only and form no part of the claimed design.

1 Claim, 8 Drawing Sheets

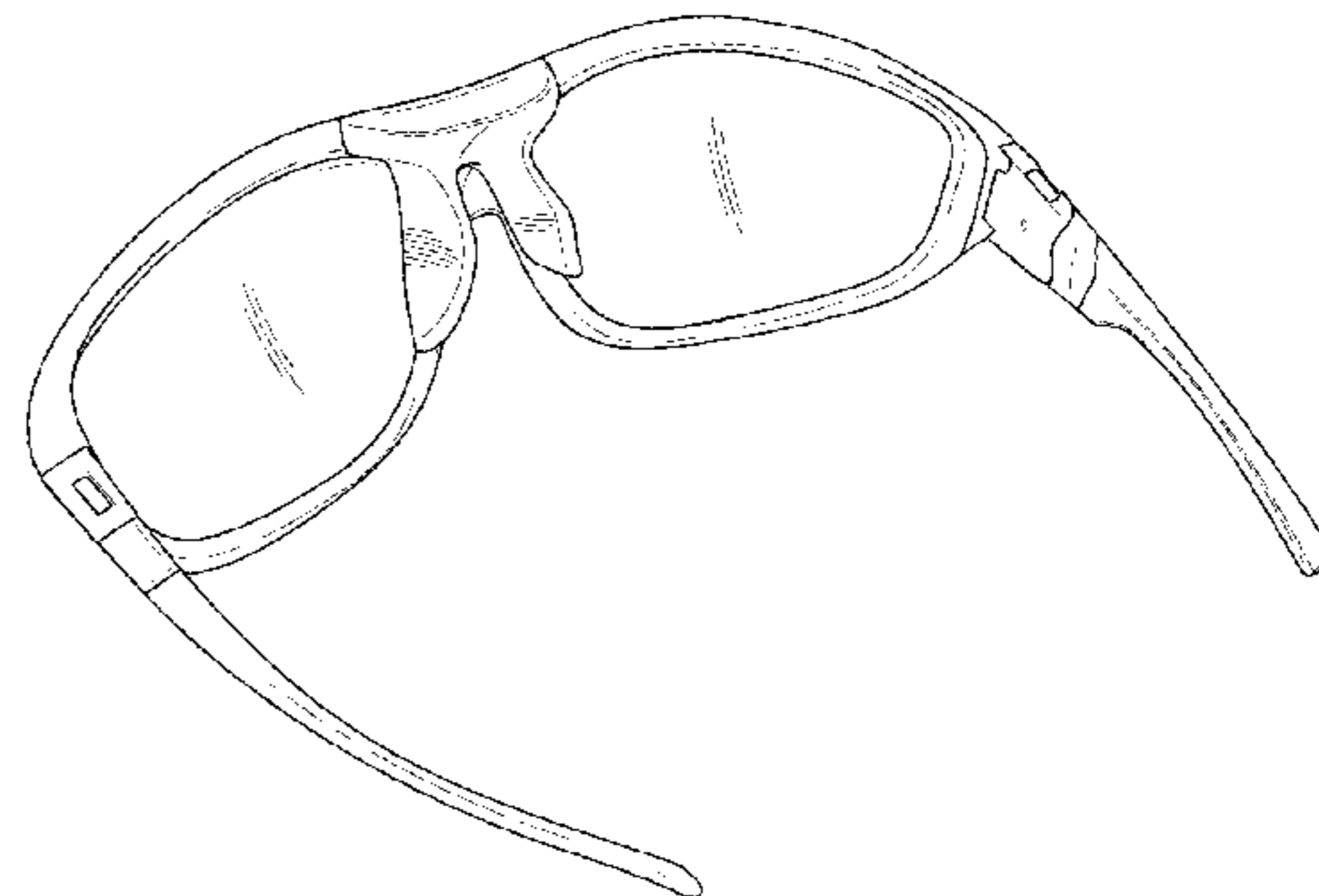
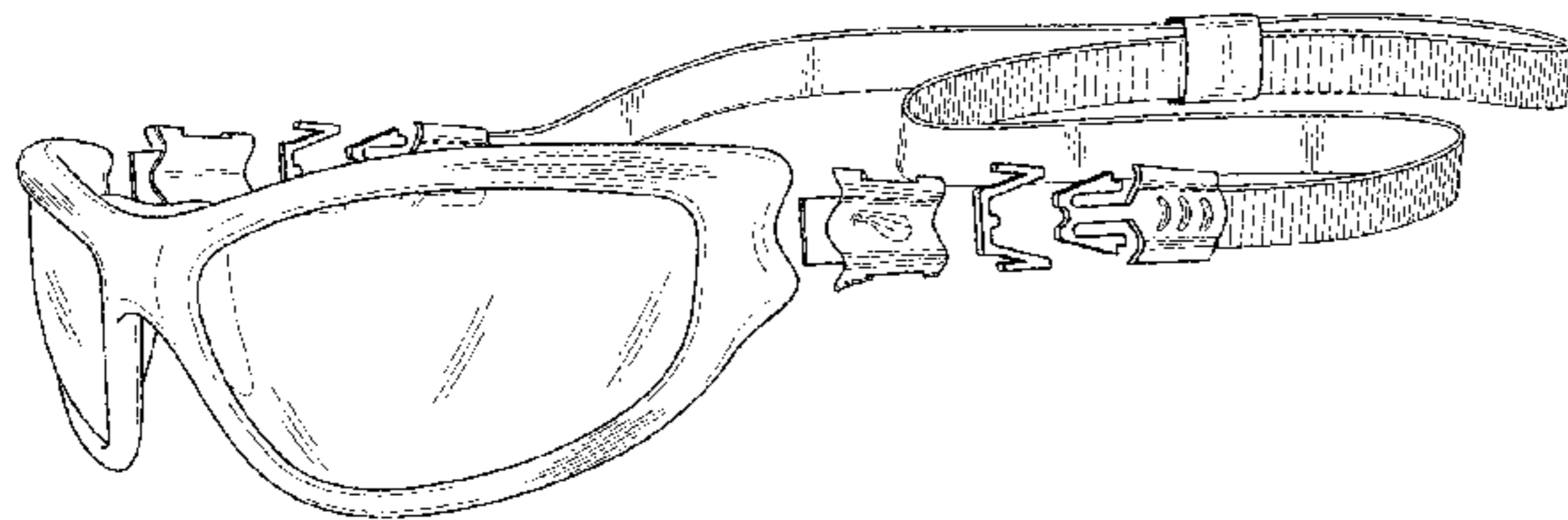

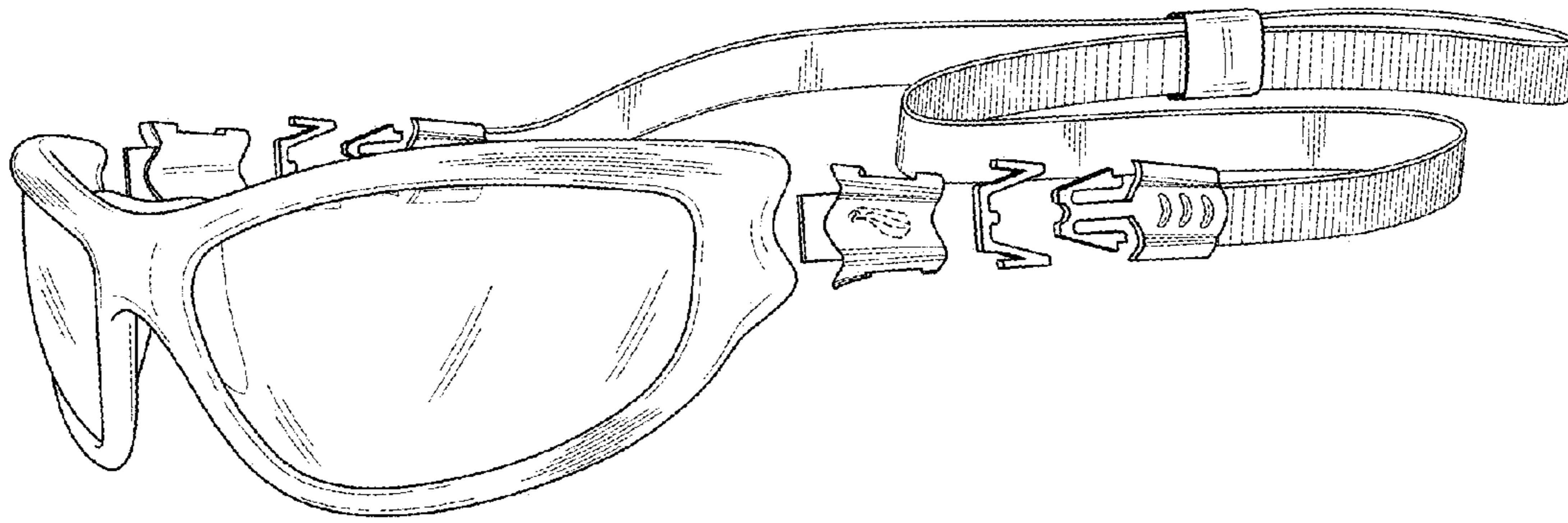

FIG. 1

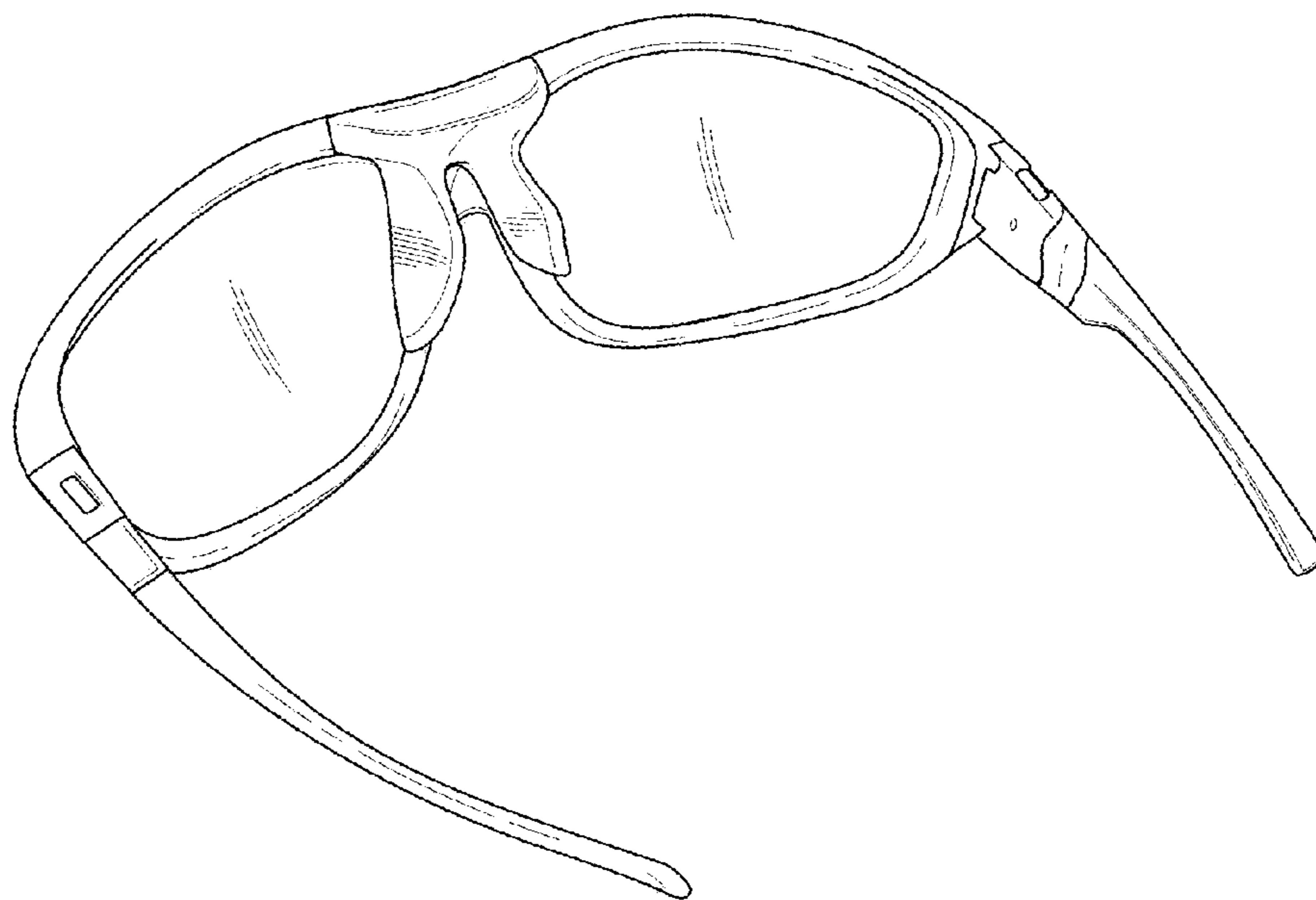

FIG. 2

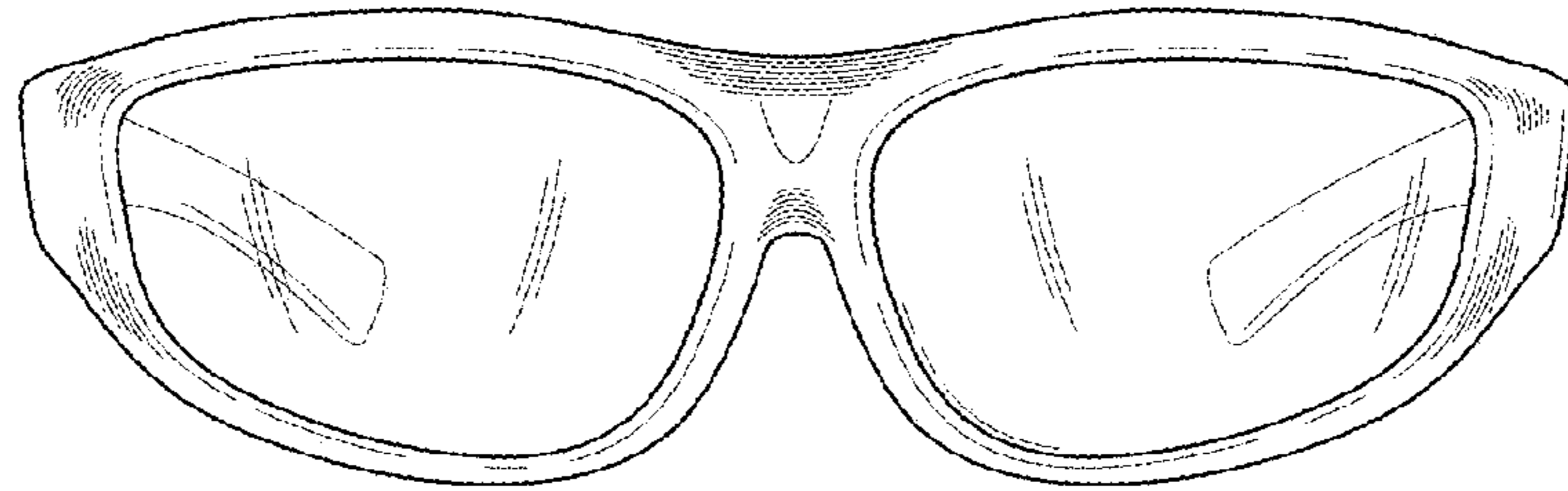

FIG. 3

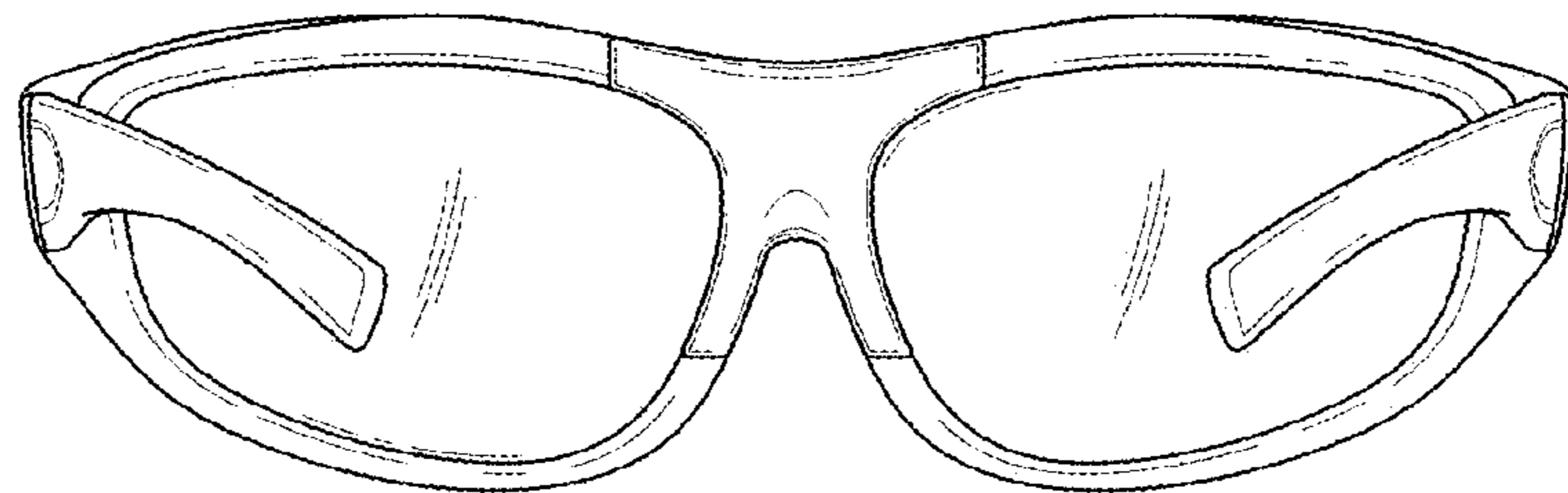

FIG. 4

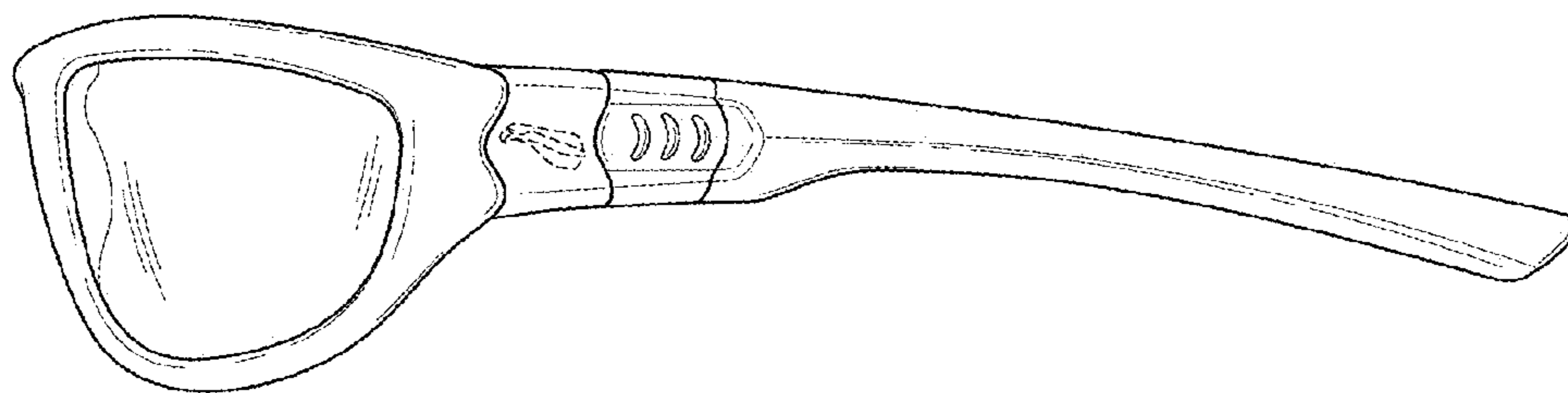

FIG. 5

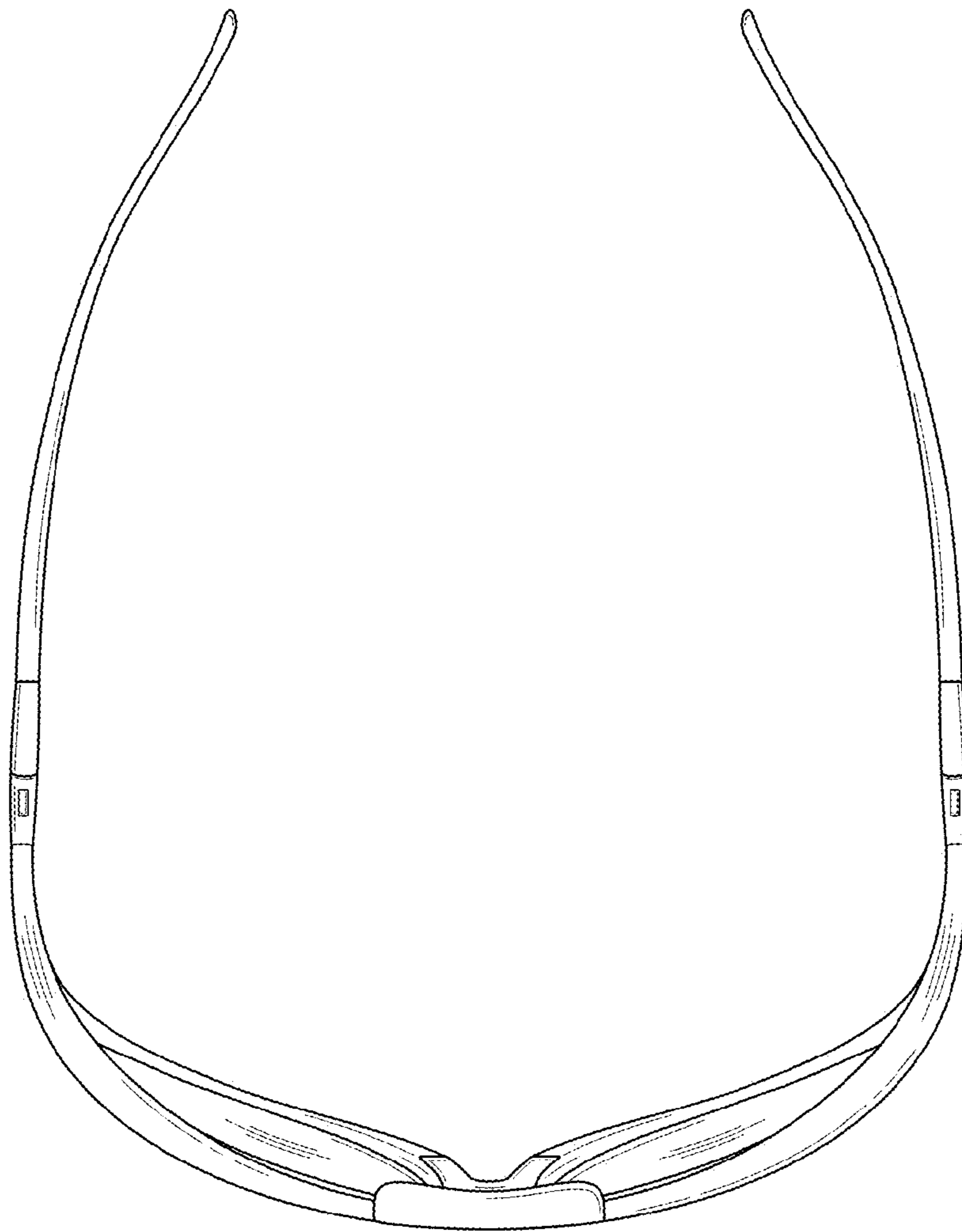

FIG. 6

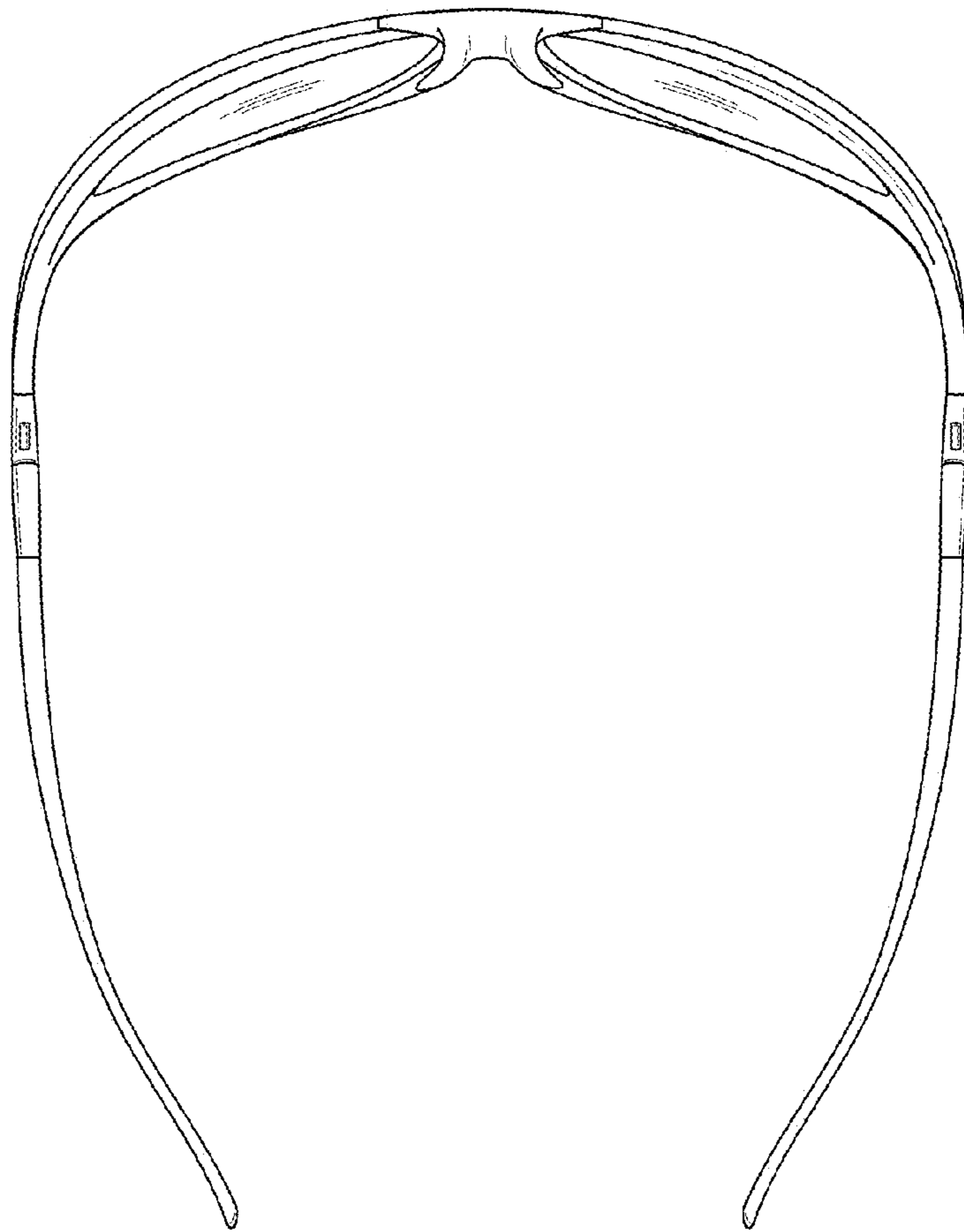

FIG. 7

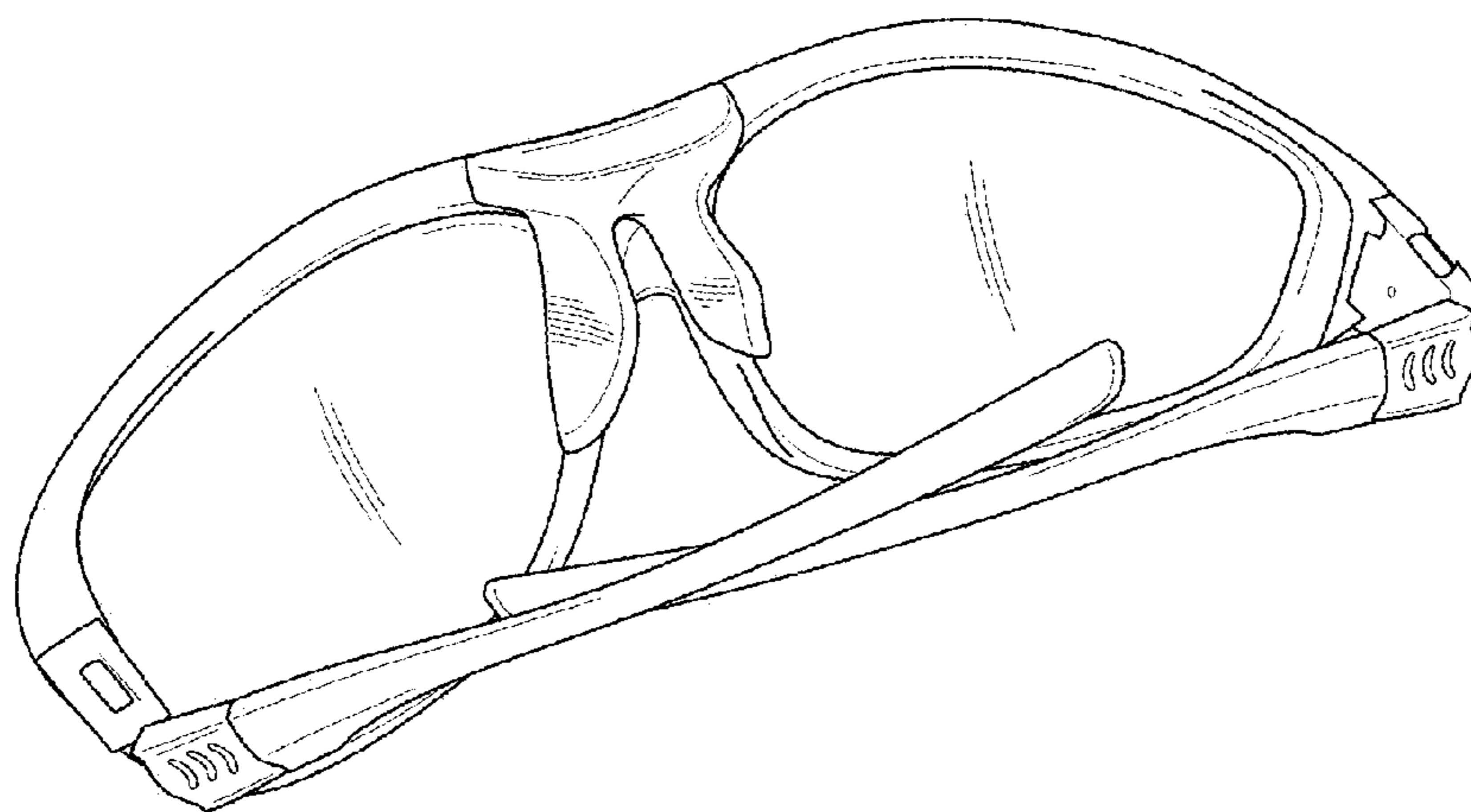

FIG. 8

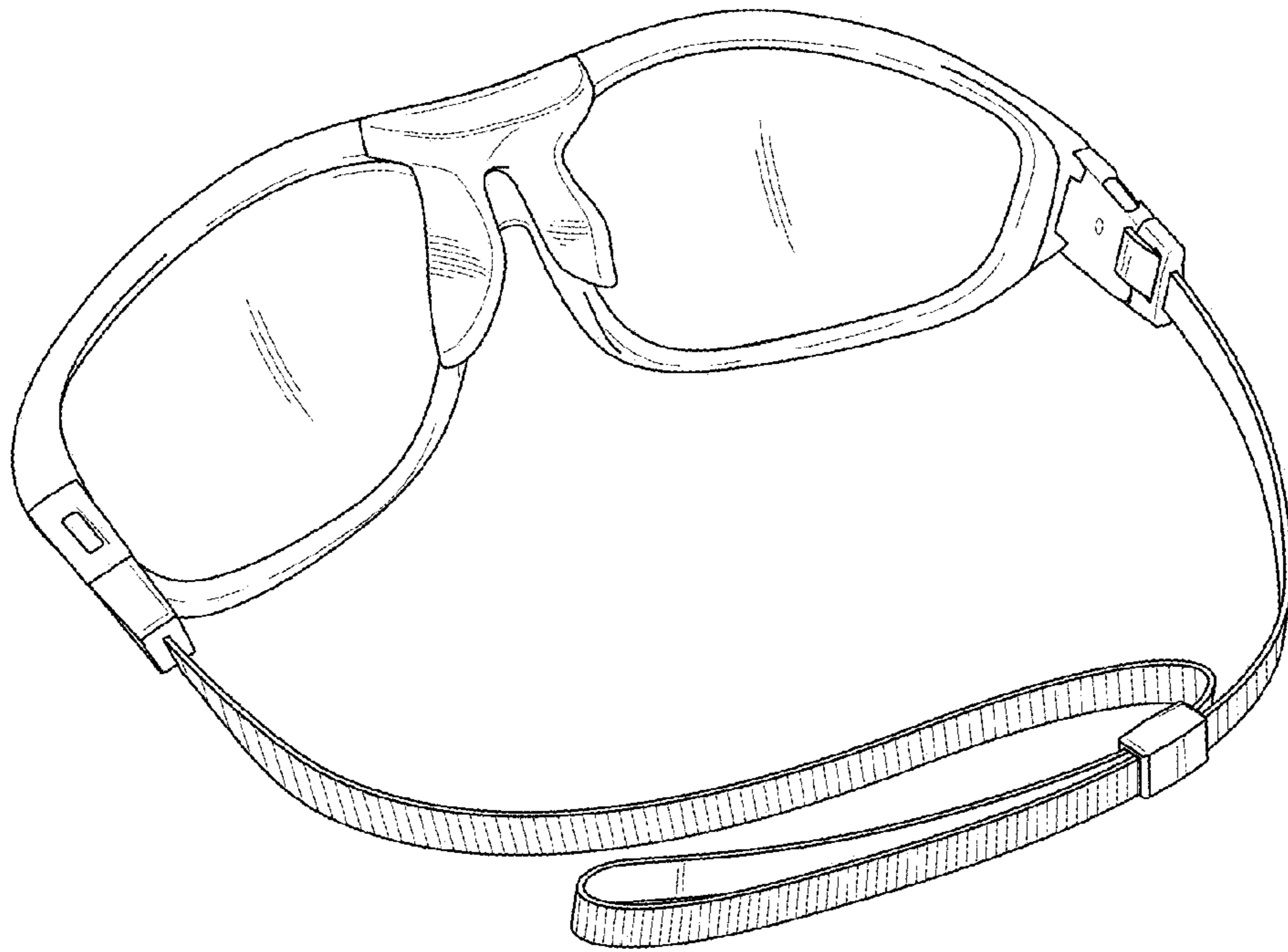

FIG. 9

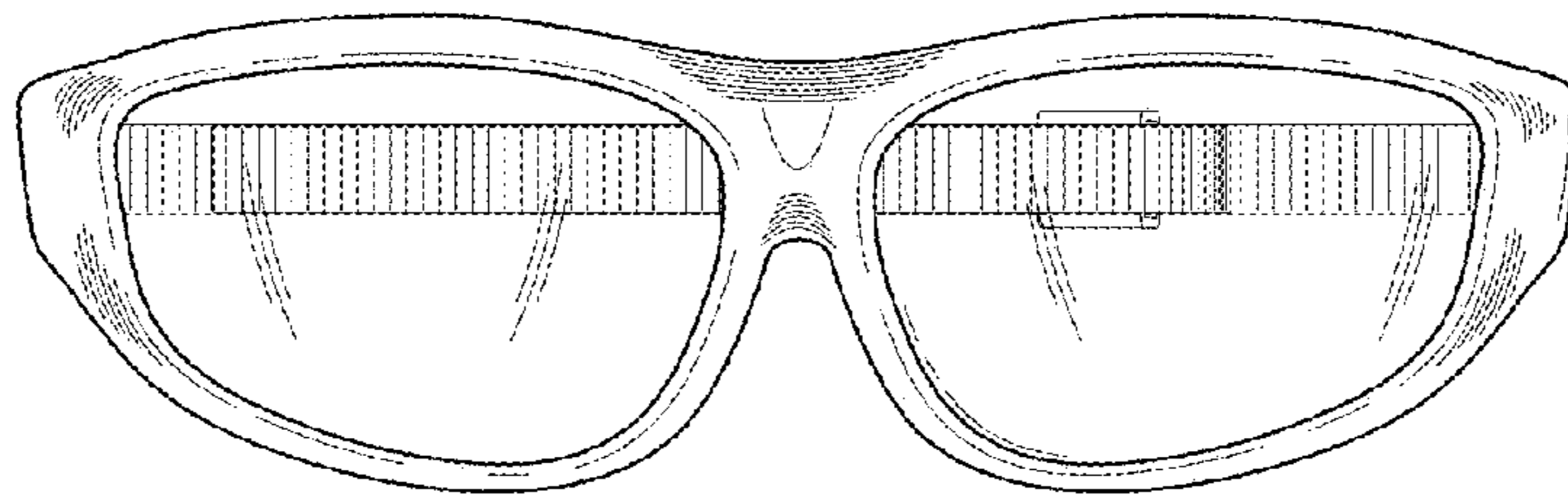

FIG. 10

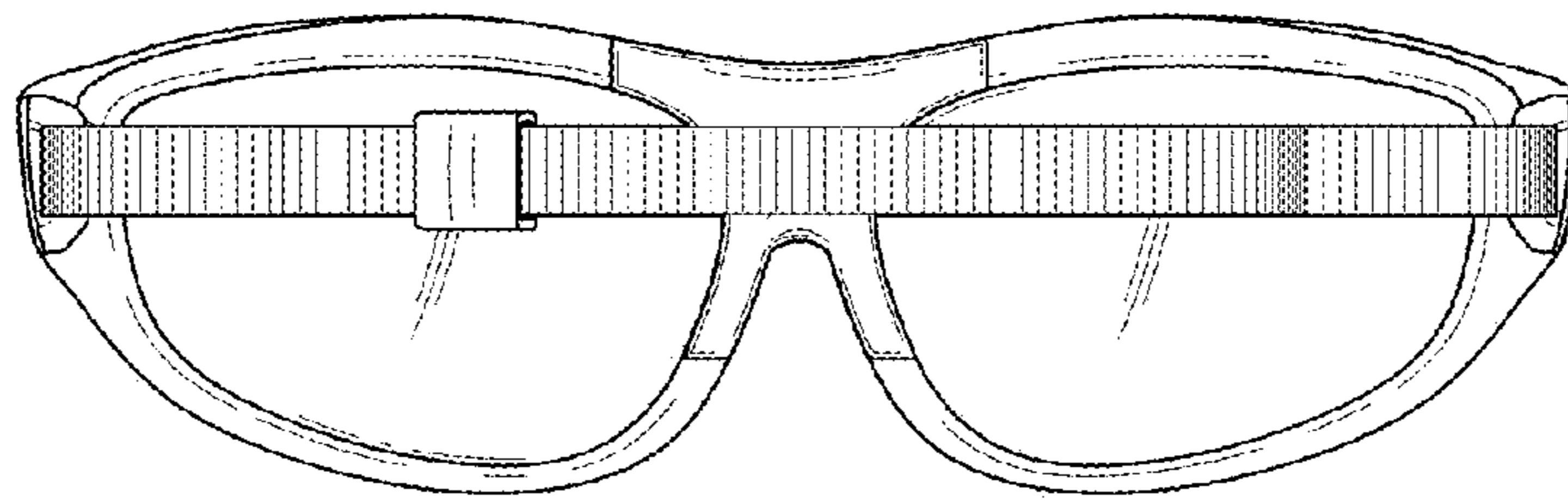

FIG. 11

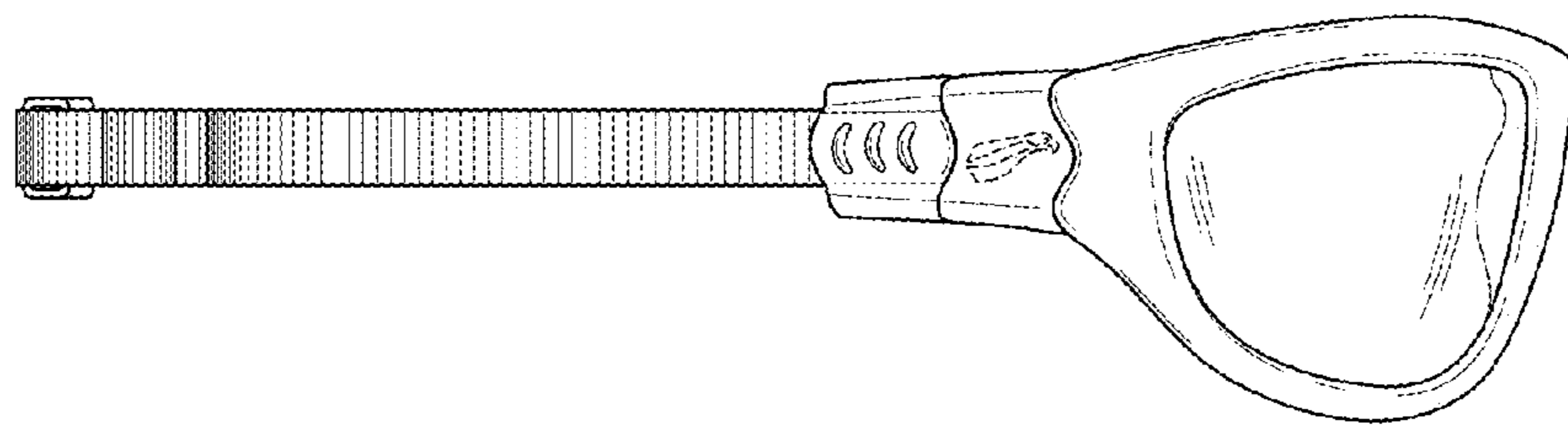

FIG. 12

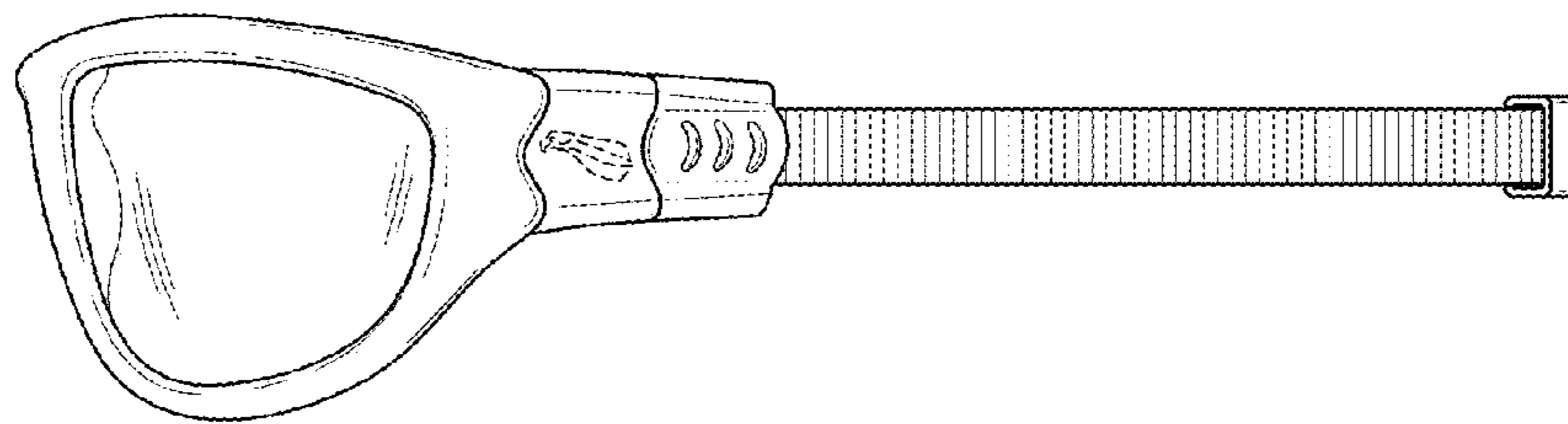

FIG. 13

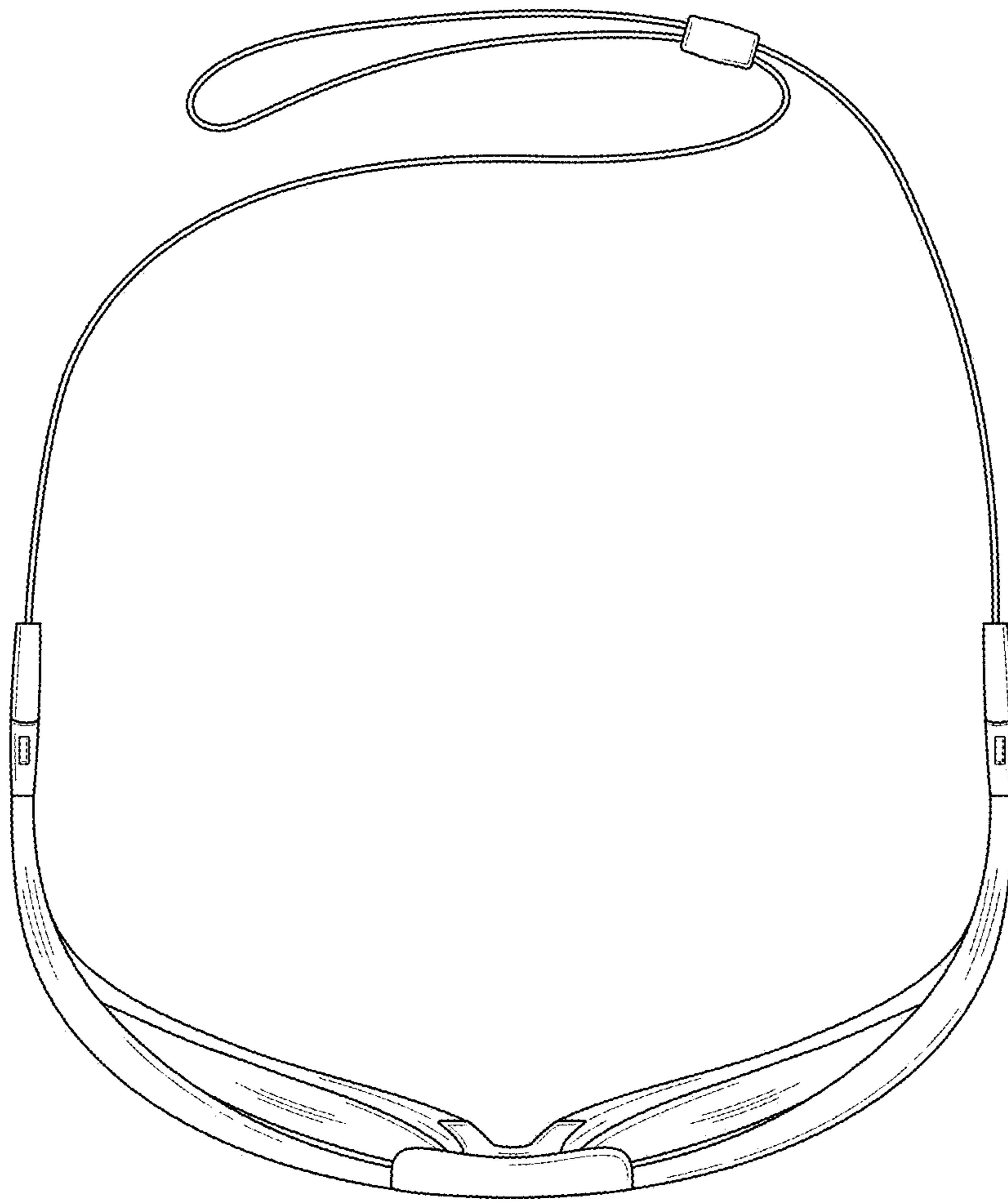

FIG. 14

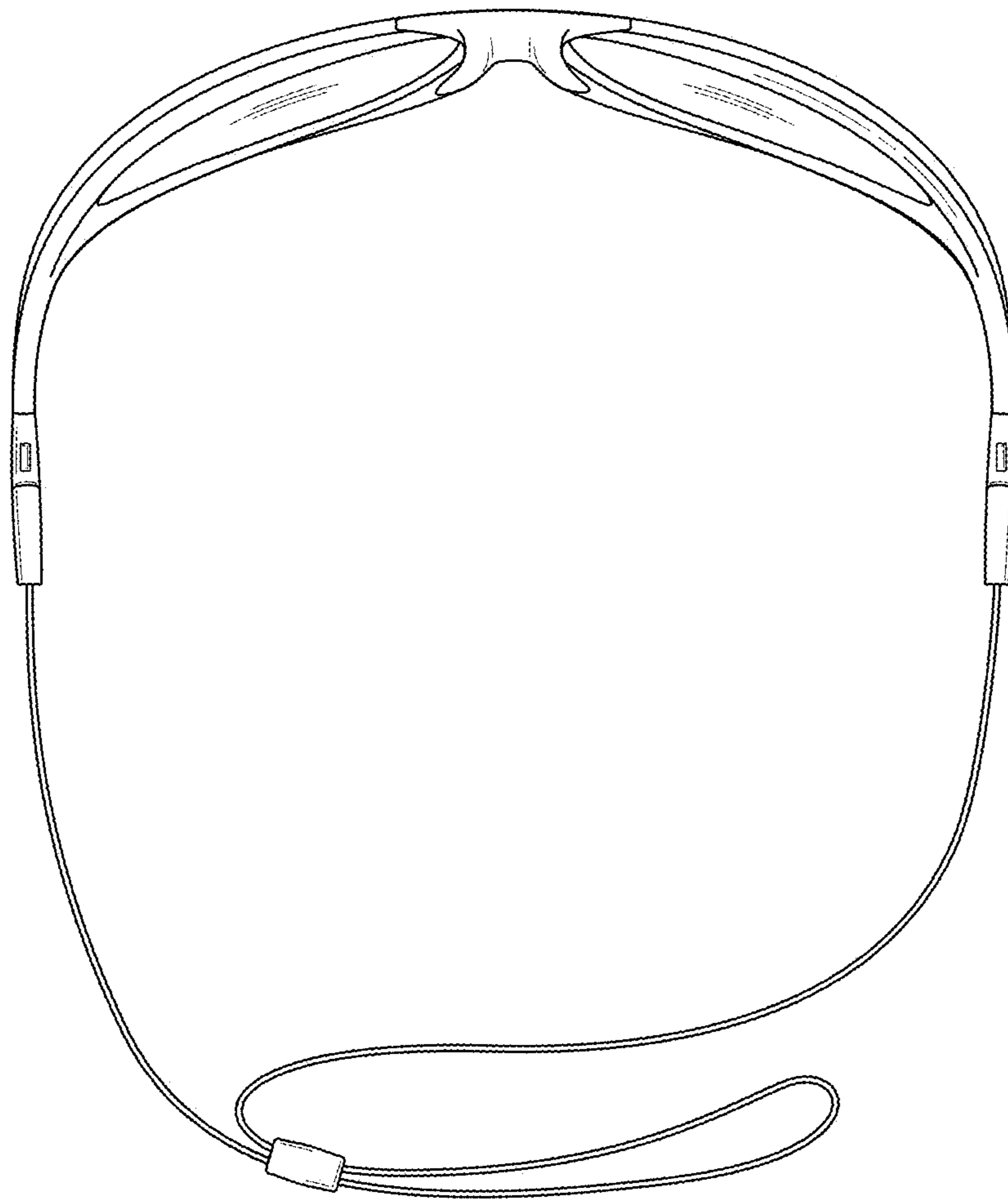

FIG. 15