



US00D700491S

(12) **United States Design Patent**
Ko

(10) **Patent No.:** **US D700,491 S**
(45) **Date of Patent:** **** Mar. 4, 2014**

- (54) **PORTION OF AN ARM OF A RIVETER**
- (71) Applicant: **Karat Industrial Corporation**, New Taipei (TW)
- (72) Inventor: **Philey Ko**, New Taipei (TW)
- (73) Assignee: **Karat Industrial Corporation**, New Taipei (TW)
- (**) Term: **14 Years**
- (21) Appl. No.: **29/454,261**
- (22) Filed: **May 8, 2013**

Related U.S. Application Data

- (63) Continuation-in-part of application No. 29/367,187, filed on Aug. 4, 2010, now abandoned.

Foreign Application Priority Data

- Feb. 26, 2010 (TW) 99203542 U
- (51) **LOC (10) CL.** **08-05**
- (52) **U.S. CL.**
USPC **D8/51**
- (58) **Field of Classification Search**
USPC D8/14.1, 61, 62, 63, 64, 65, 66, 44, 51;
173/169, 178, 213, 217, 114; 227/130,
227/136, 142; 81/57.11, 429, 464, 465
See application file for complete search history.

References Cited

U.S. PATENT DOCUMENTS

- 553,284 A * 1/1896 Jaberg 227/55
- D196,140 S * 8/1963 Pickford D8/51

(Continued)

Primary Examiner — Austin Murphy

(74) *Attorney, Agent, or Firm* — C. G. Mersereau; Nikolai & Mersereau, P.A.

(57) **CLAIM**

The ornamental design for a portion of an arm of a riveter, as shown and described.

DESCRIPTION

FIG. 1 is a top perspective view of a first embodiment of a portion of an arm of a riveter showing my new design; FIG. 2 is a front view of FIG. 1; FIG. 3 is a rear view of FIG. 1; FIG. 4 is a left view of FIG. 1; FIG. 5 is a right view of FIG. 1; FIG. 6 is a top view of FIG. 1; FIG. 7 is a bottom view of FIG. 1; FIG. 8 is another perspective view of FIG. 1; FIG. 9 is a top perspective view of a second embodiment of a portion of an arm of a riveter showing my new design; FIG. 10 is a front view of FIG. 9; FIG. 11 is a rear view of FIG. 9; FIG. 12 is a left view of FIG. 9; FIG. 13 is a right view of FIG. 9; FIG. 14 is a top view of FIG. 9; FIG. 15 is a bottom view of FIG. 9; and FIG. 16 is another perspective view of FIG. 9.

FIG. 17 is a top perspective view of a first embodiment of a portion of an arm of a riveter showing my new design; FIG. 18 is a front view of FIG. 17; FIG. 19 is a rear view of FIG. 17; FIG. 20 is a left view of FIG. 17; FIG. 21 is a right view of FIG. 17; FIG. 22 is a top view of FIG. 17; FIG. 23 is a bottom view of FIG. 17; FIG. 24 is another perspective view of FIG. 17; FIG. 25 is a top perspective view of a second embodiment of a portion of an arm of a riveter showing my new design; FIG. 26 is a front view of FIG. 25; FIG. 27 is a rear view of FIG. 25; FIG. 28 is a left view of FIG. 25; FIG. 29 is a right view of FIG. 25; FIG. 30 is a top view of FIG. 25; FIG. 31 is a bottom view of FIG. 25; and, FIG. 32 is another perspective view of FIG. 25.

In the drawings, the broken lines shown in the figures depict environmental subject matter only and form no part of the claimed design.

1 Claim, 24 Drawing Sheets

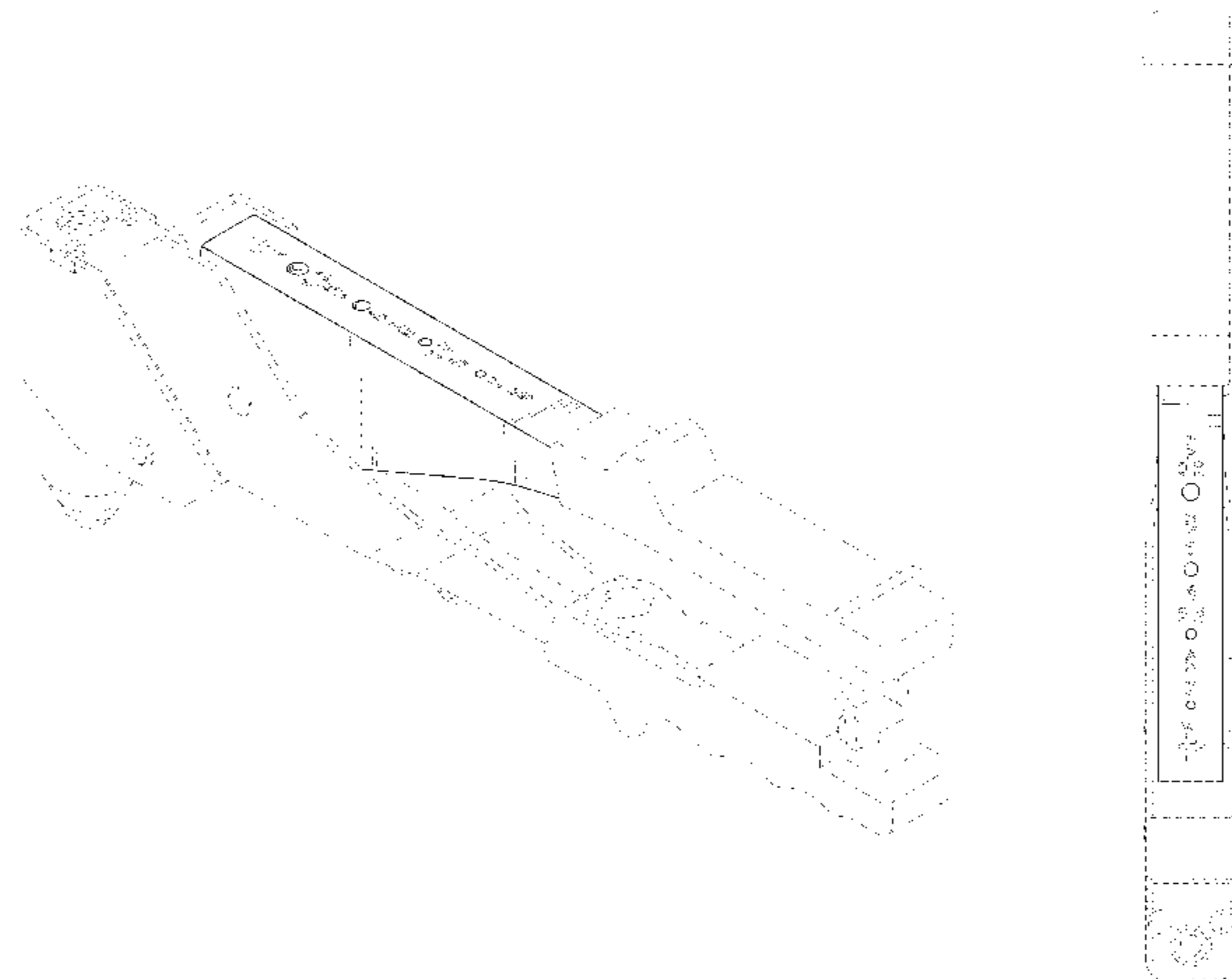

(56)

References Cited

U.S. PATENT DOCUMENTS

3,324,700 A * 6/1967 Elliott 29/243.528
3,596,496 A * 8/1971 La Pointe 29/243.521
3,842,649 A * 10/1974 Di Maio 29/243.528
D247,214 S * 2/1978 Wolf D8/51
4,147,047 A * 4/1979 Fluester 72/391.8
D383,047 S * 9/1997 Scherer et al. D8/107

D407,615 S * 4/1999 Cerulo et al. D8/51
6,085,400 A * 7/2000 Liu 29/243.521
6,115,900 A * 9/2000 Cerulo et al. 29/243.521
6,474,129 B1 * 11/2002 Anquetin 72/391.8
6,588,246 B2 * 7/2003 Ko 29/243.528
6,711,930 B2 * 3/2004 Thom et al. 72/409.01
D520,316 S * 5/2006 Churoux D8/52
7,243,525 B2 * 7/2007 Galluzo 72/409.1
7,377,017 B1 * 5/2008 Manak 29/243.521

* cited by examiner

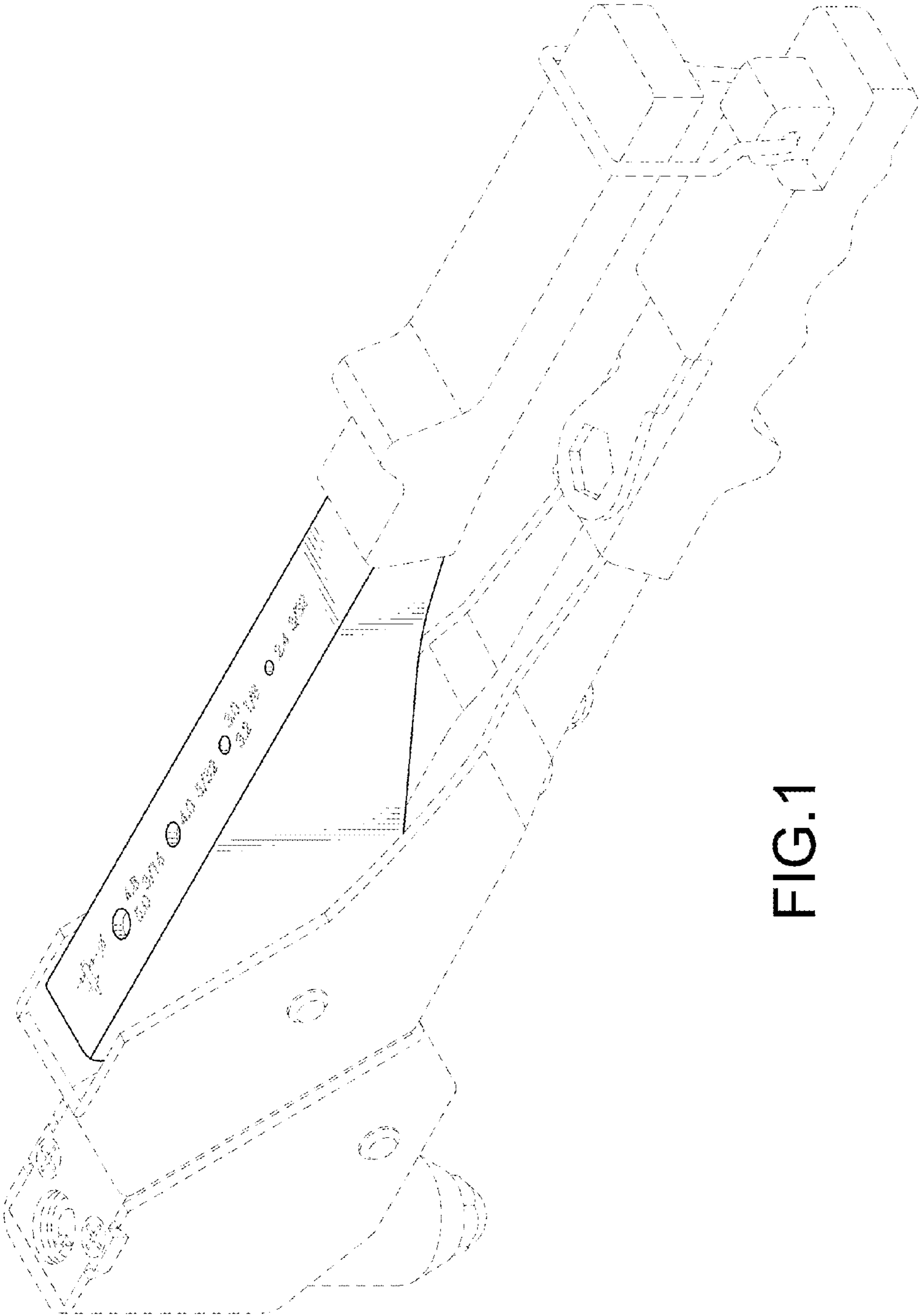

FIG.1

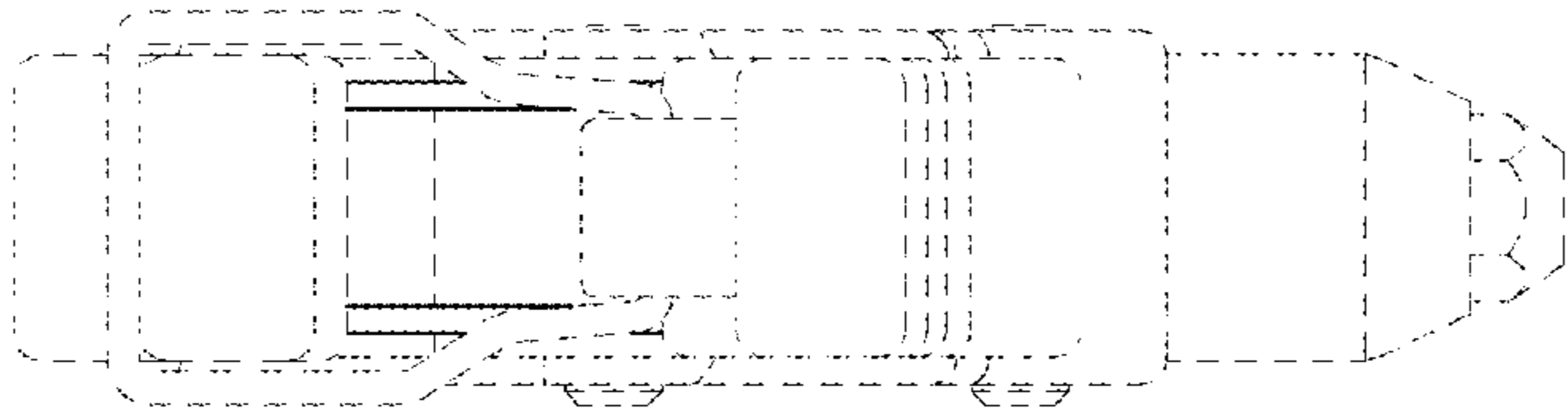

FIG.3

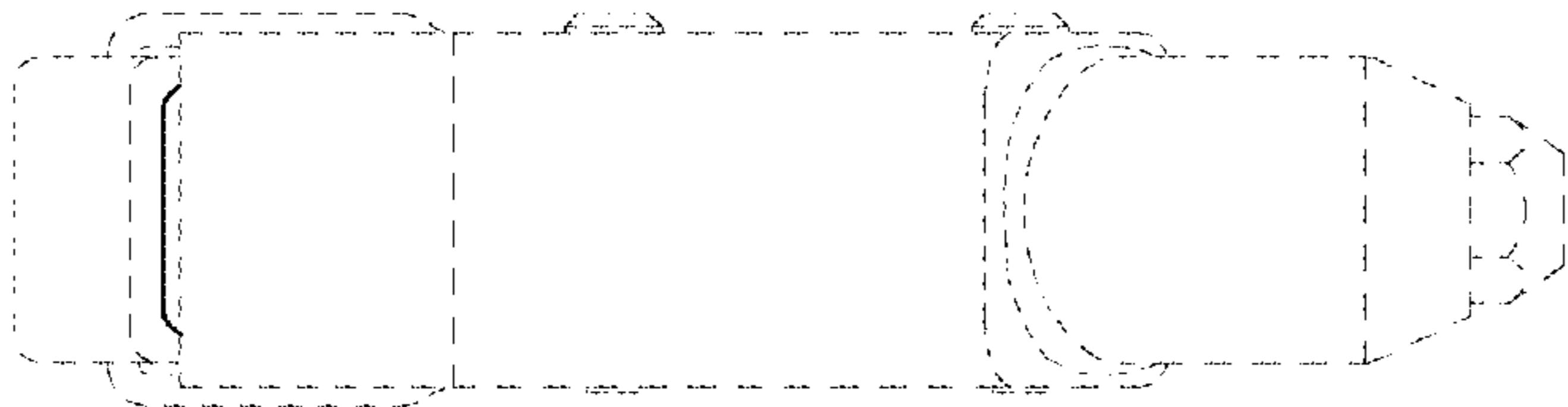

FIG.2

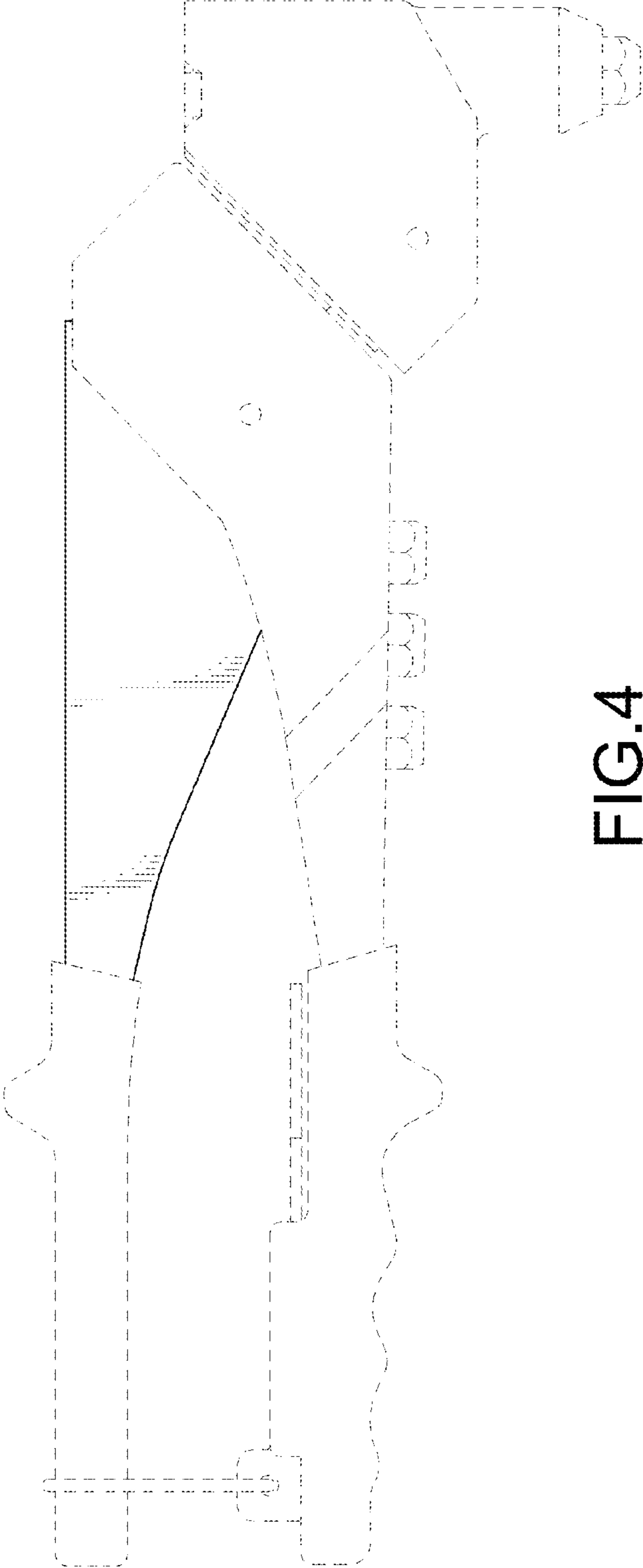

FIG.4

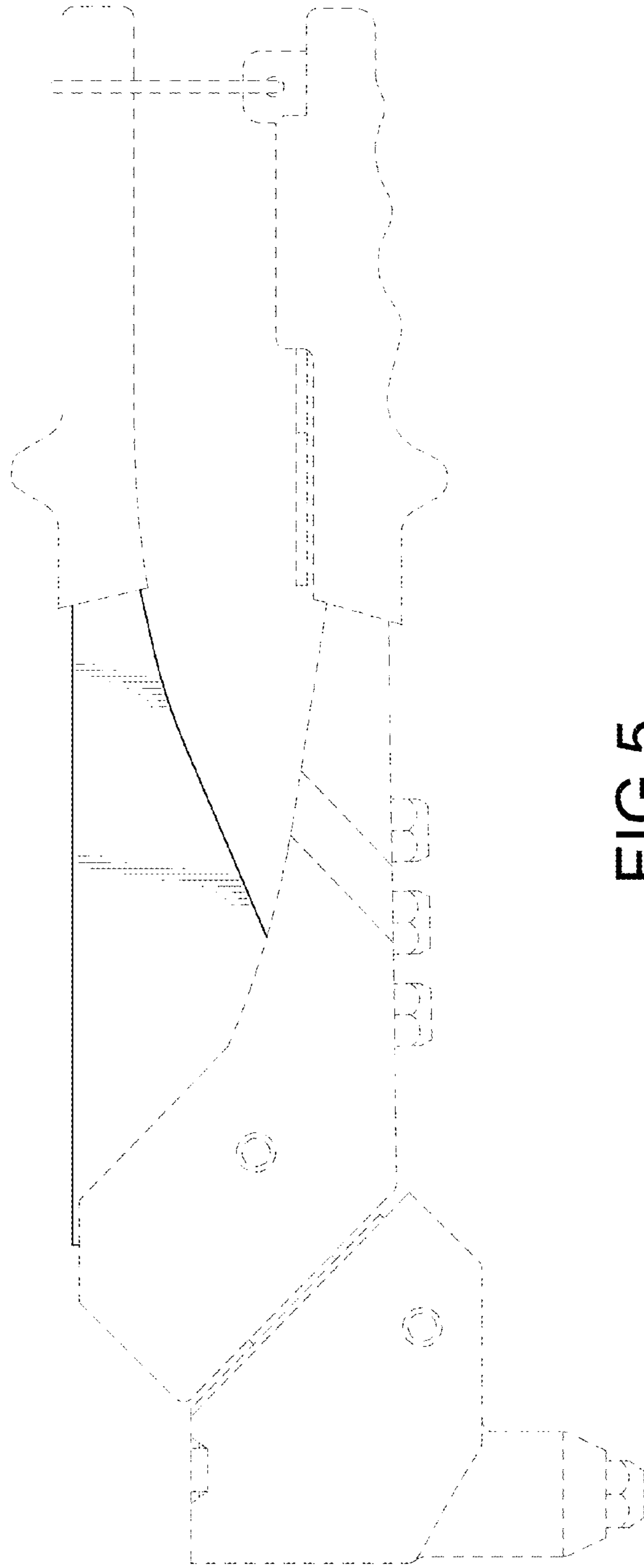

FIG. 5

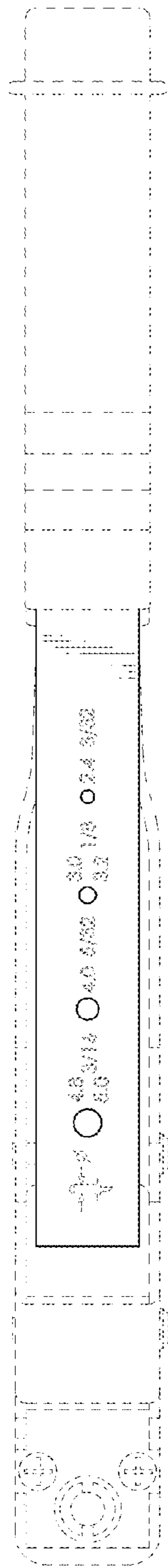

FIG.6

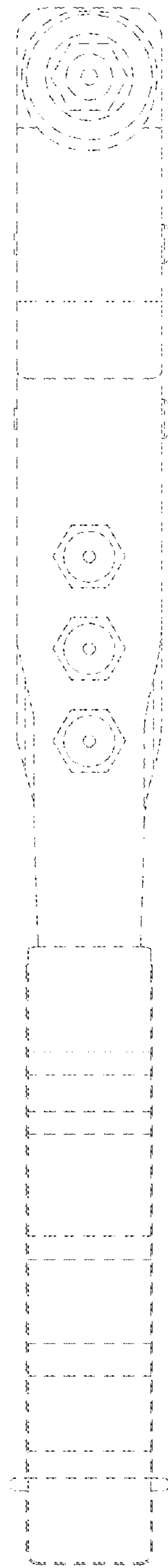

FIG.7

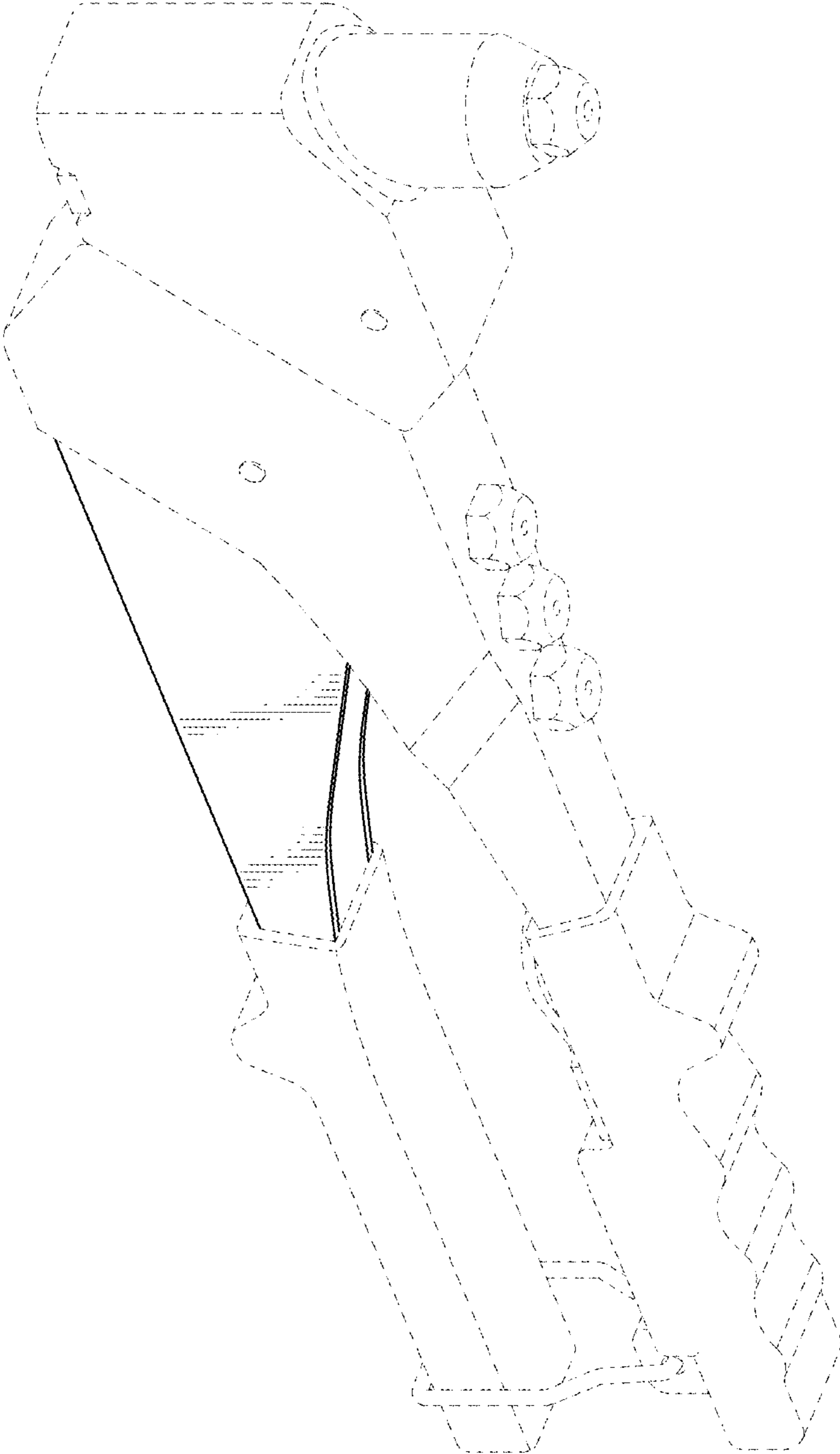

FIG. 8

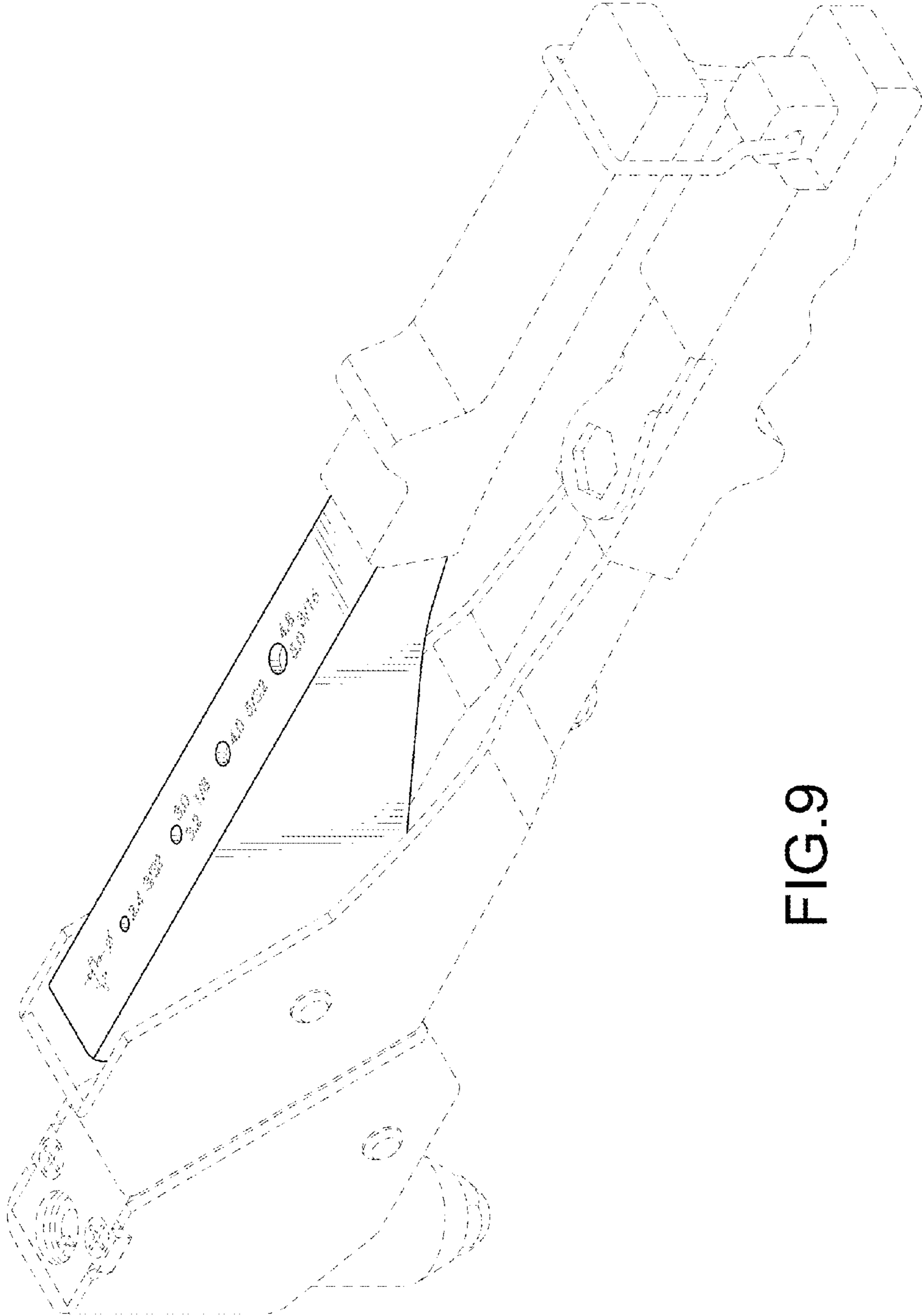

FIG.9

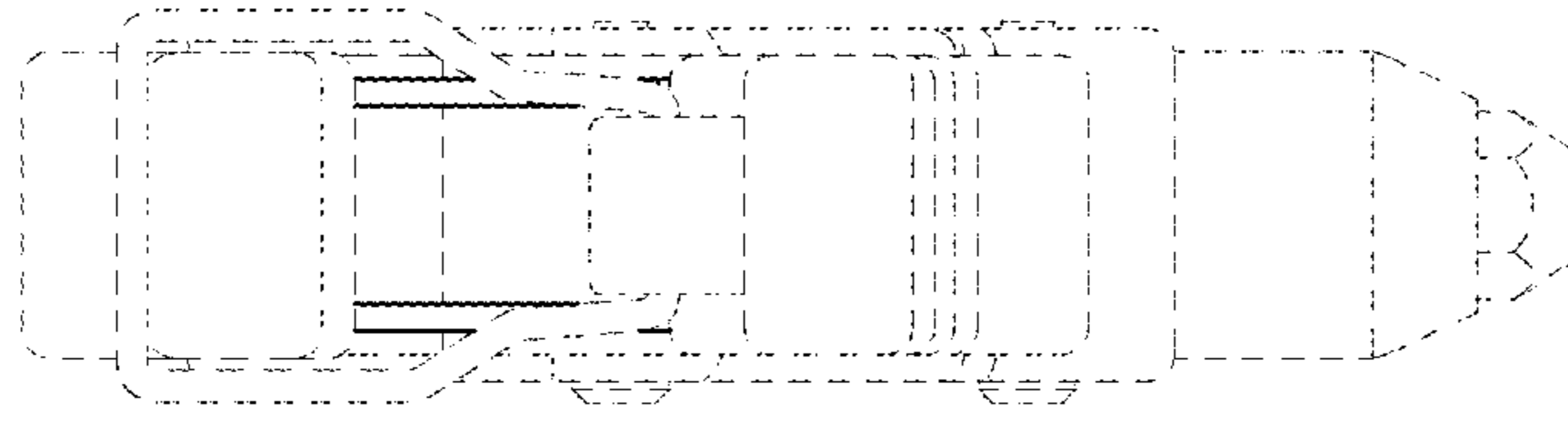

FIG.10

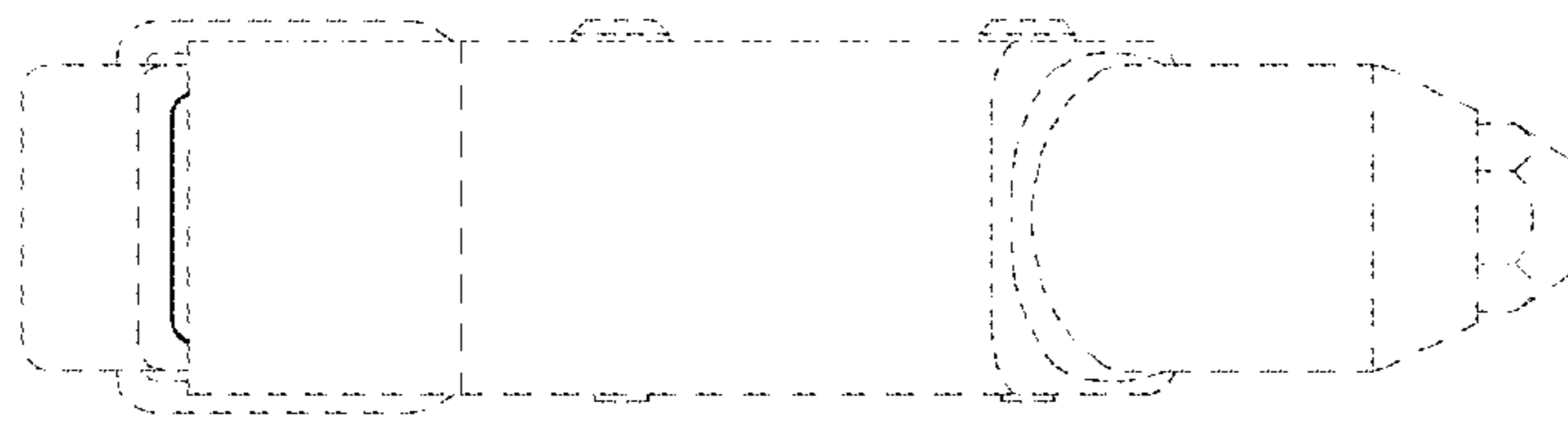

FIG.11

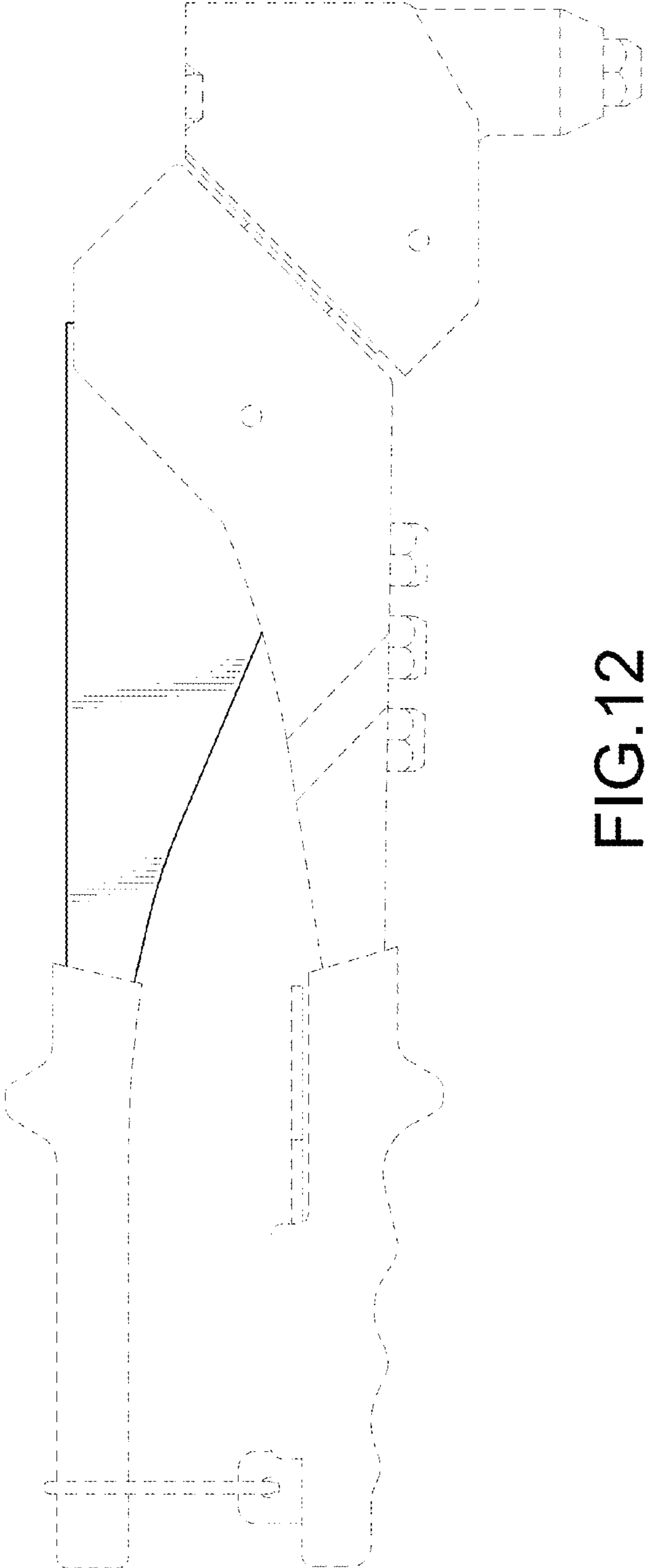

FIG.12

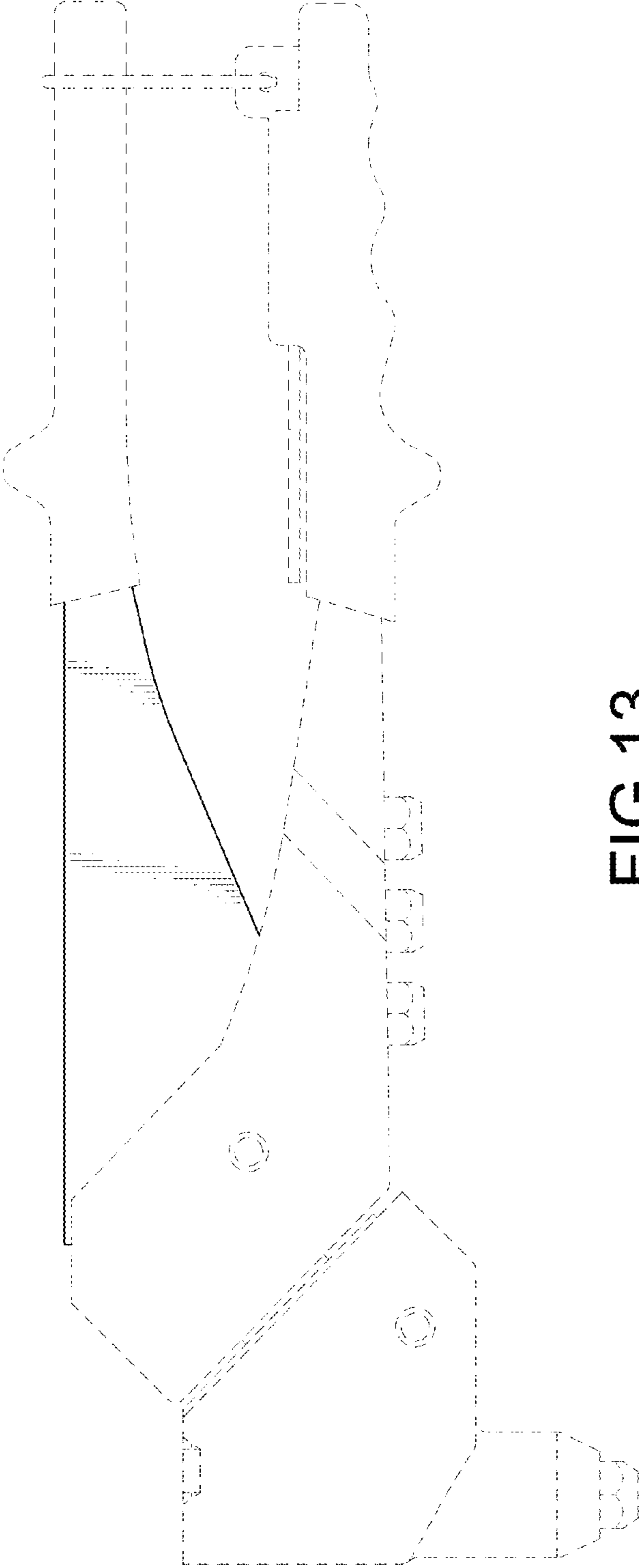

FIG.13

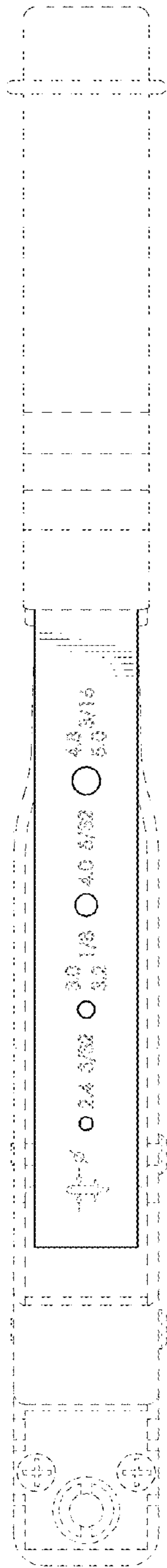

FIG.14

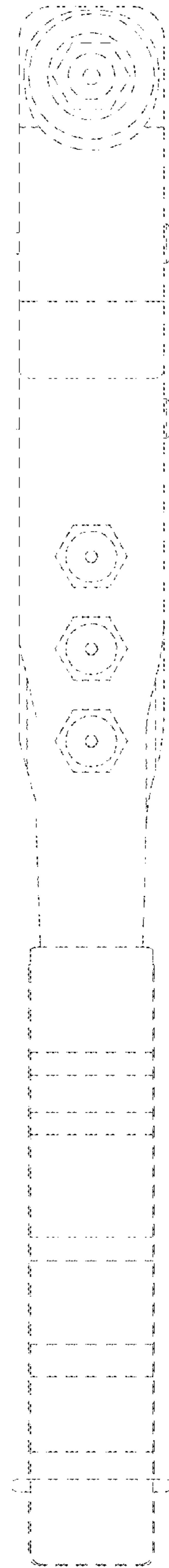

FIG.15



FIG. 16

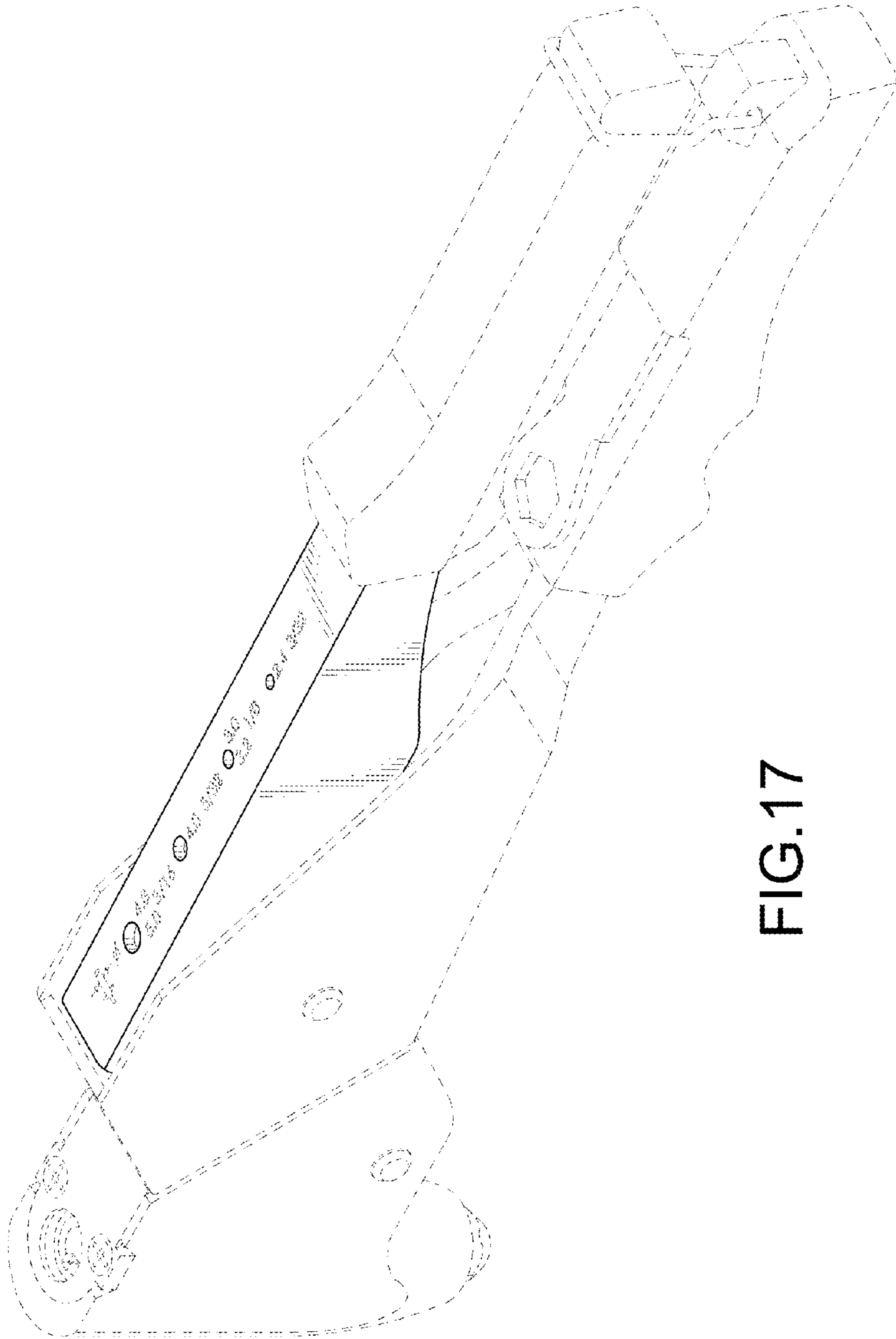

FIG.17

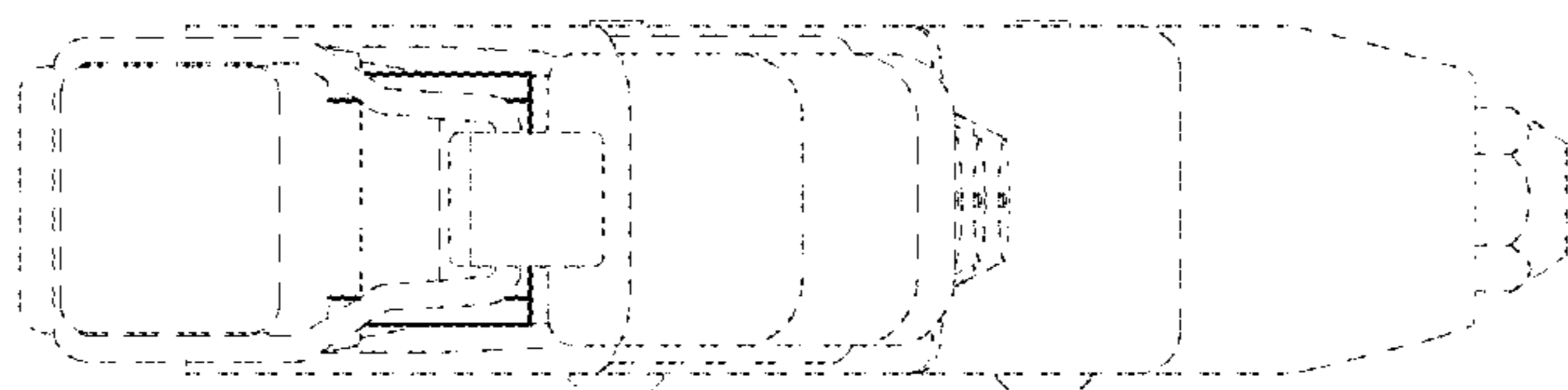

FIG.19

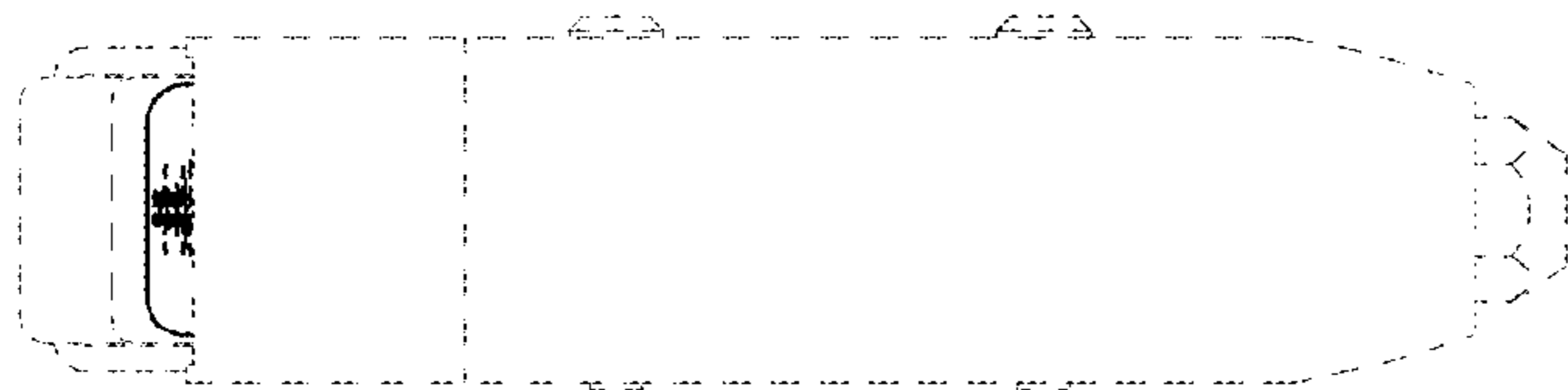

FIG.18

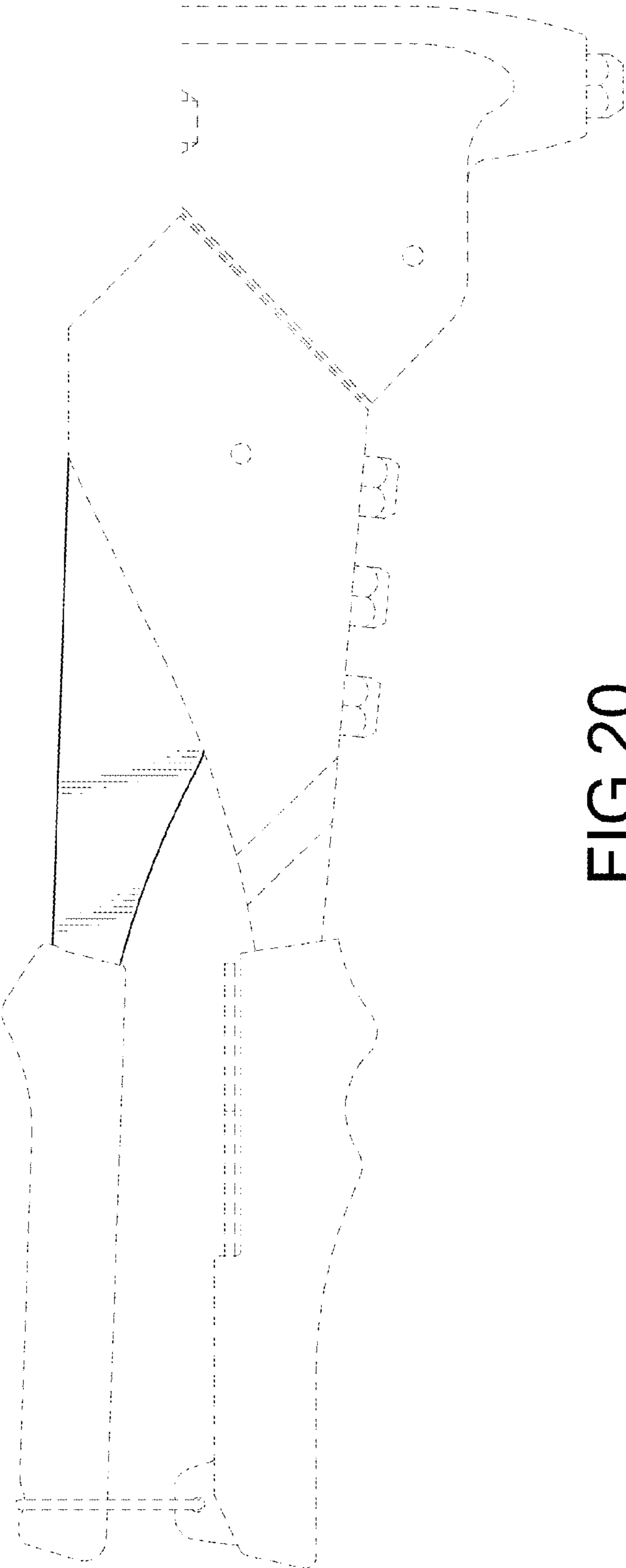

FIG.20



FIG. 21

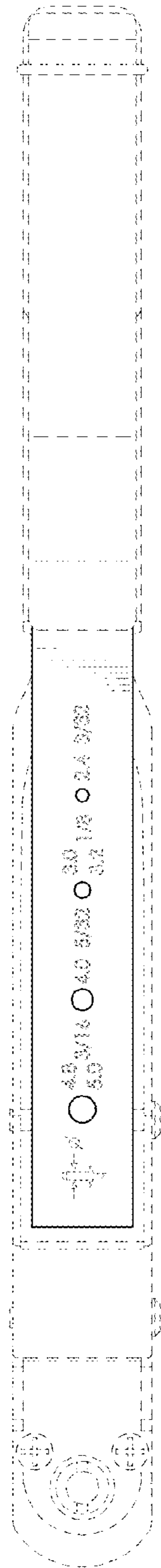

FIG. 22

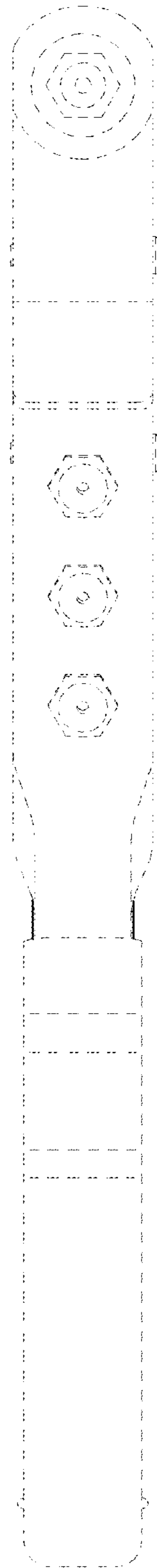

FIG. 23

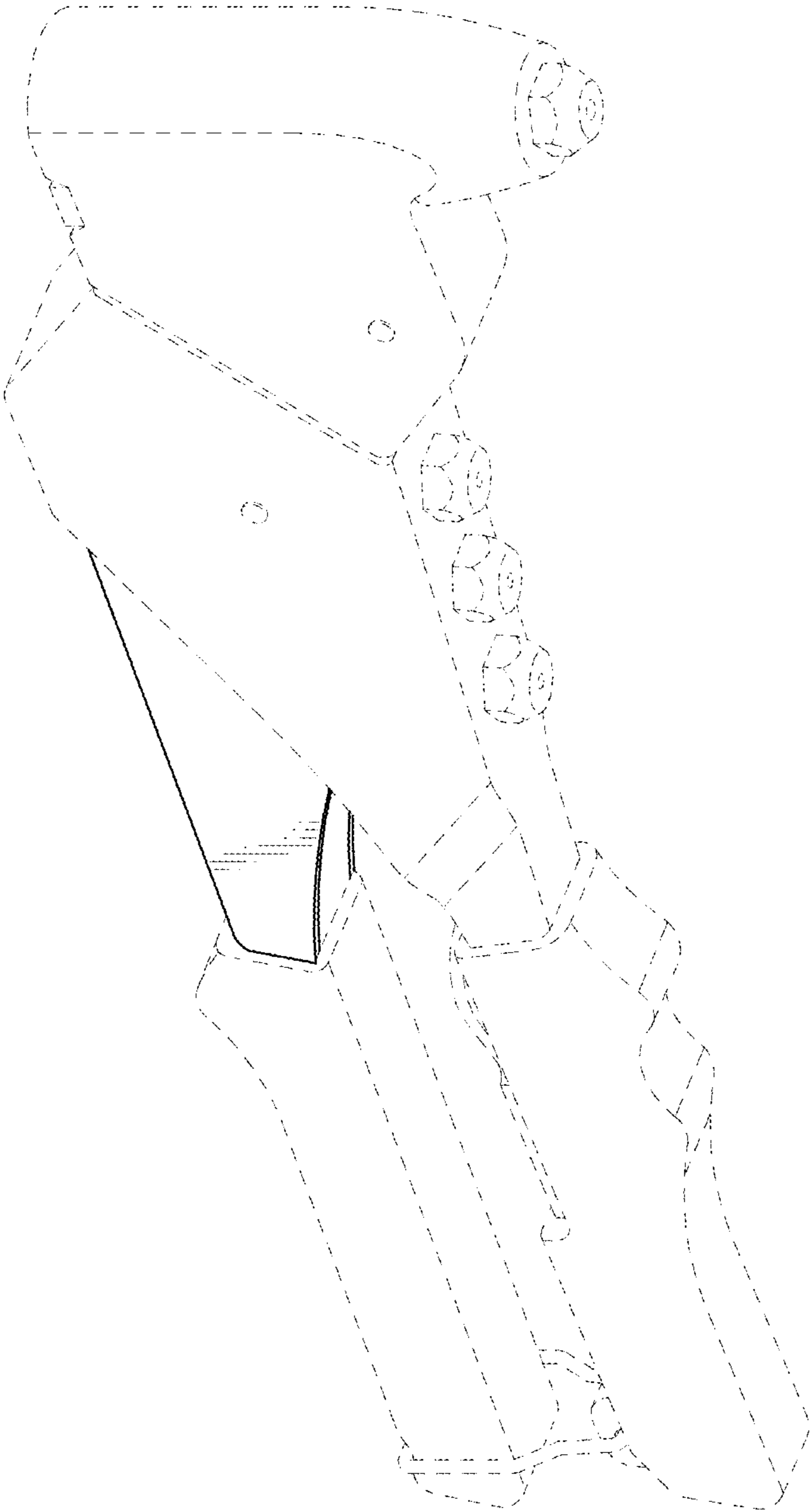

FIG.24

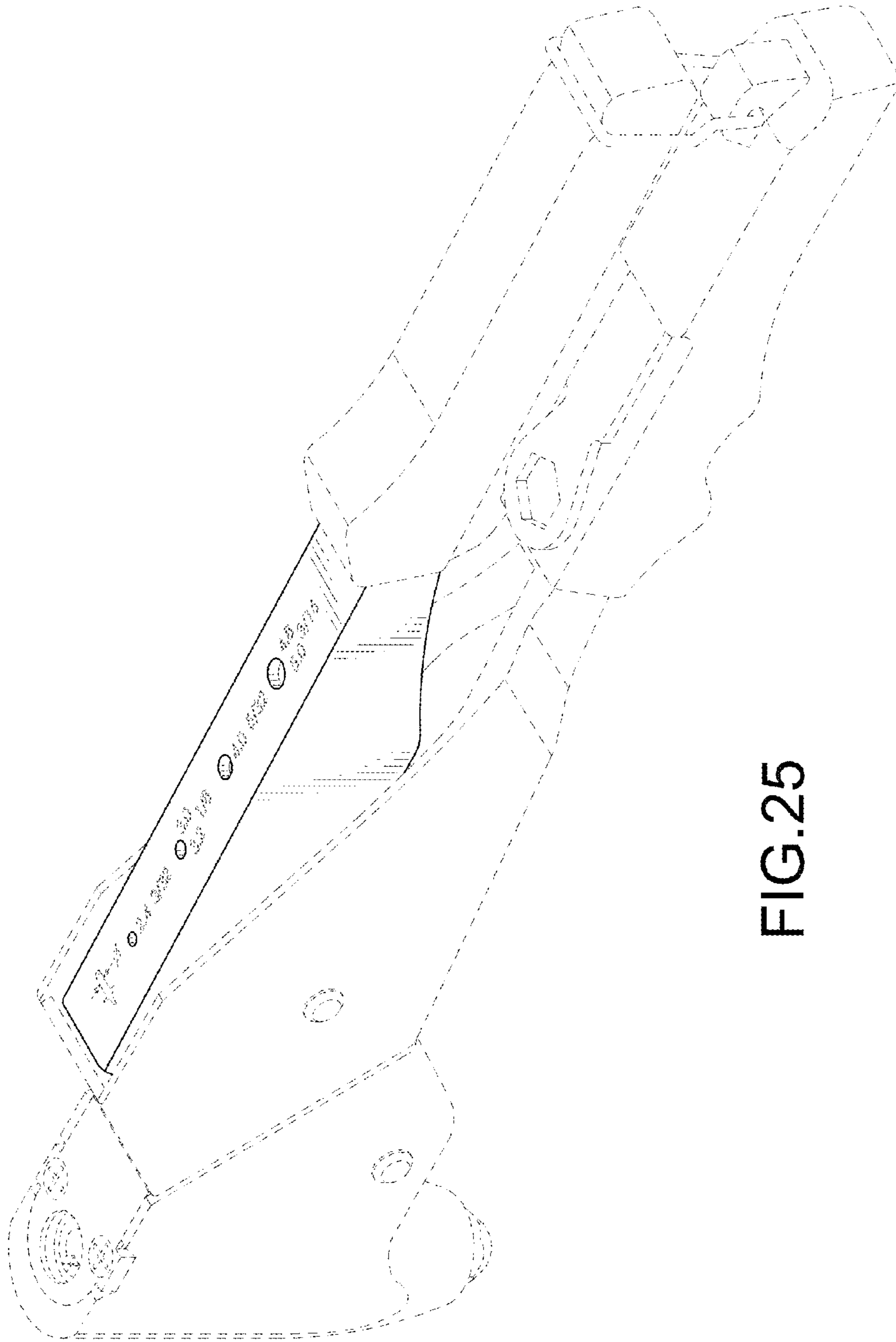

FIG.25

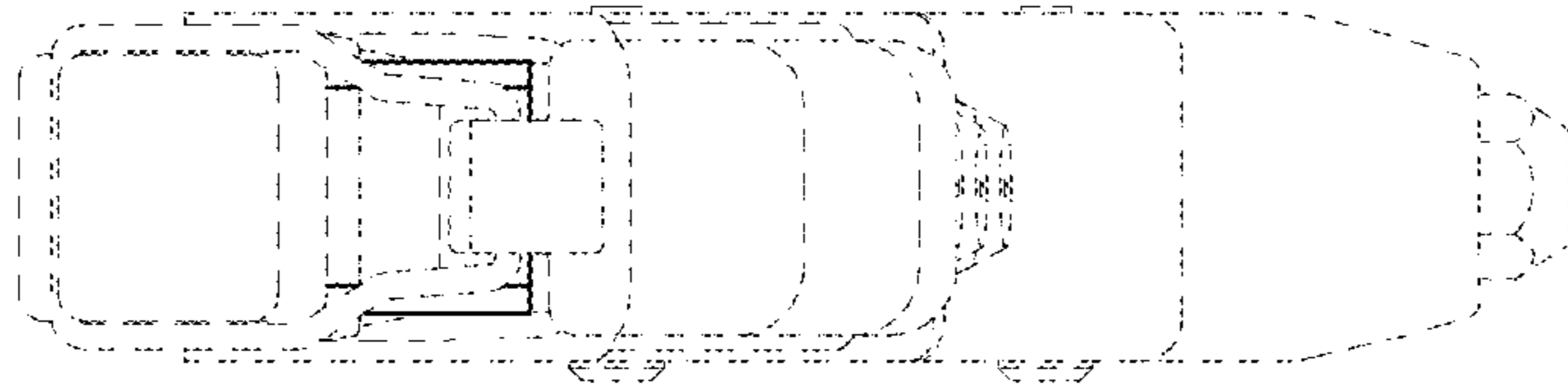

FIG. 27

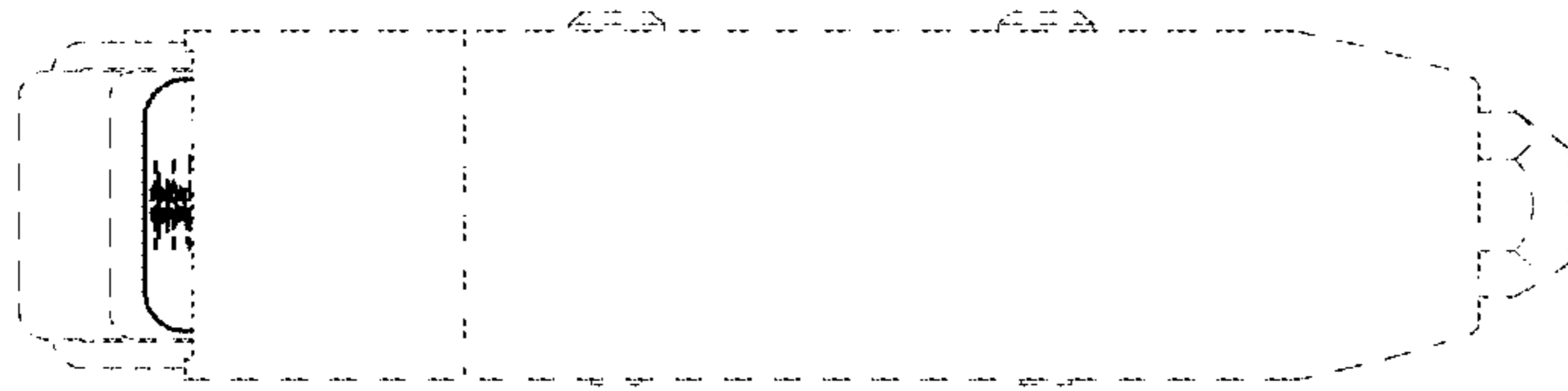

FIG. 26

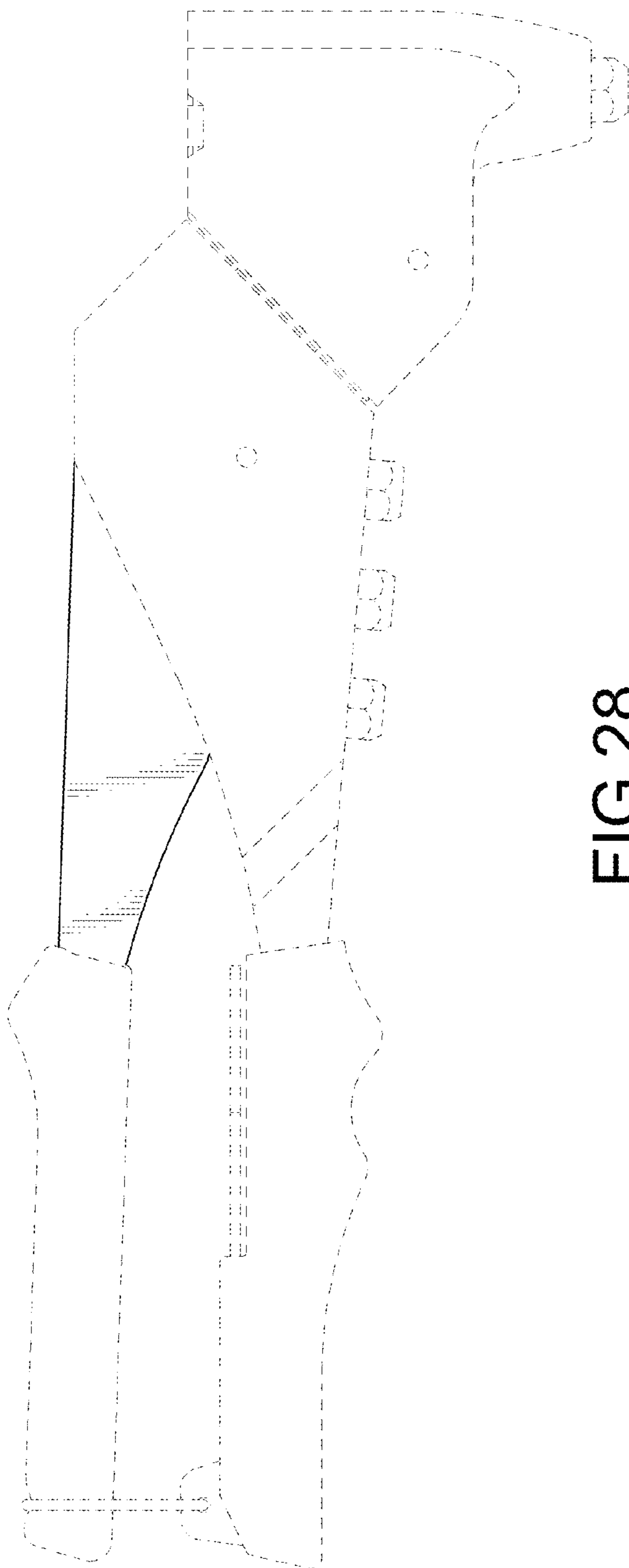

FIG.28

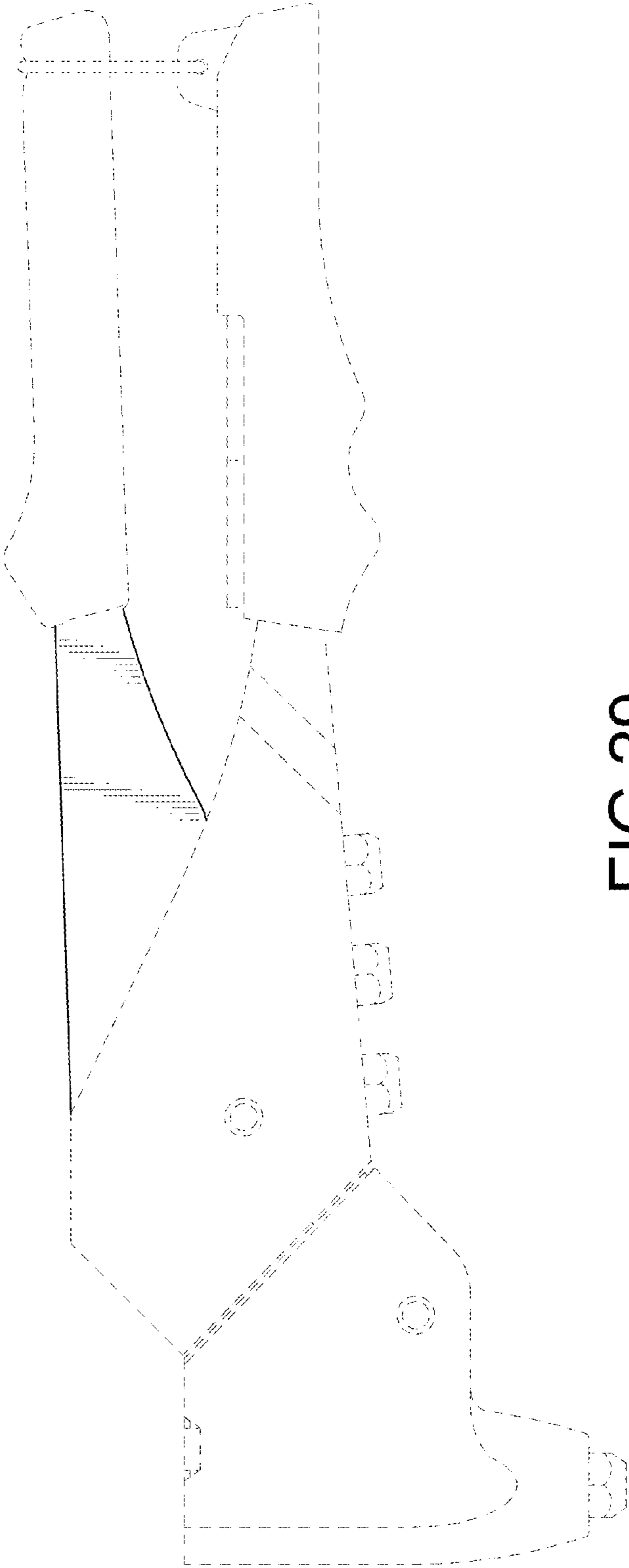

FIG. 29

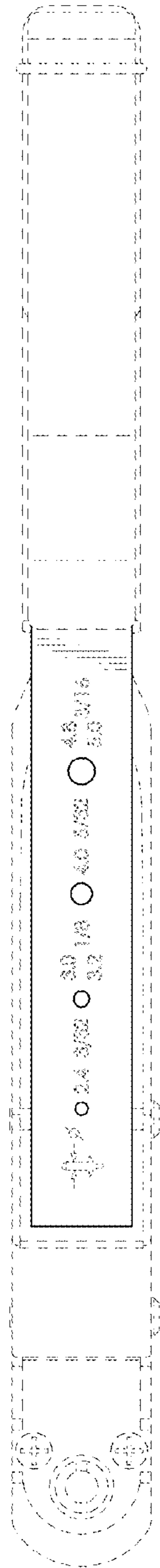

FIG.30

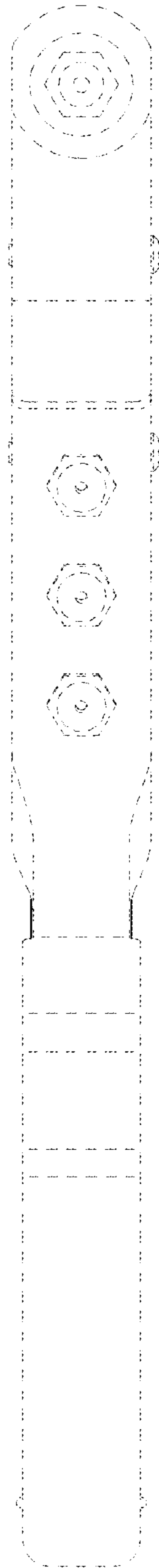

FIG.31

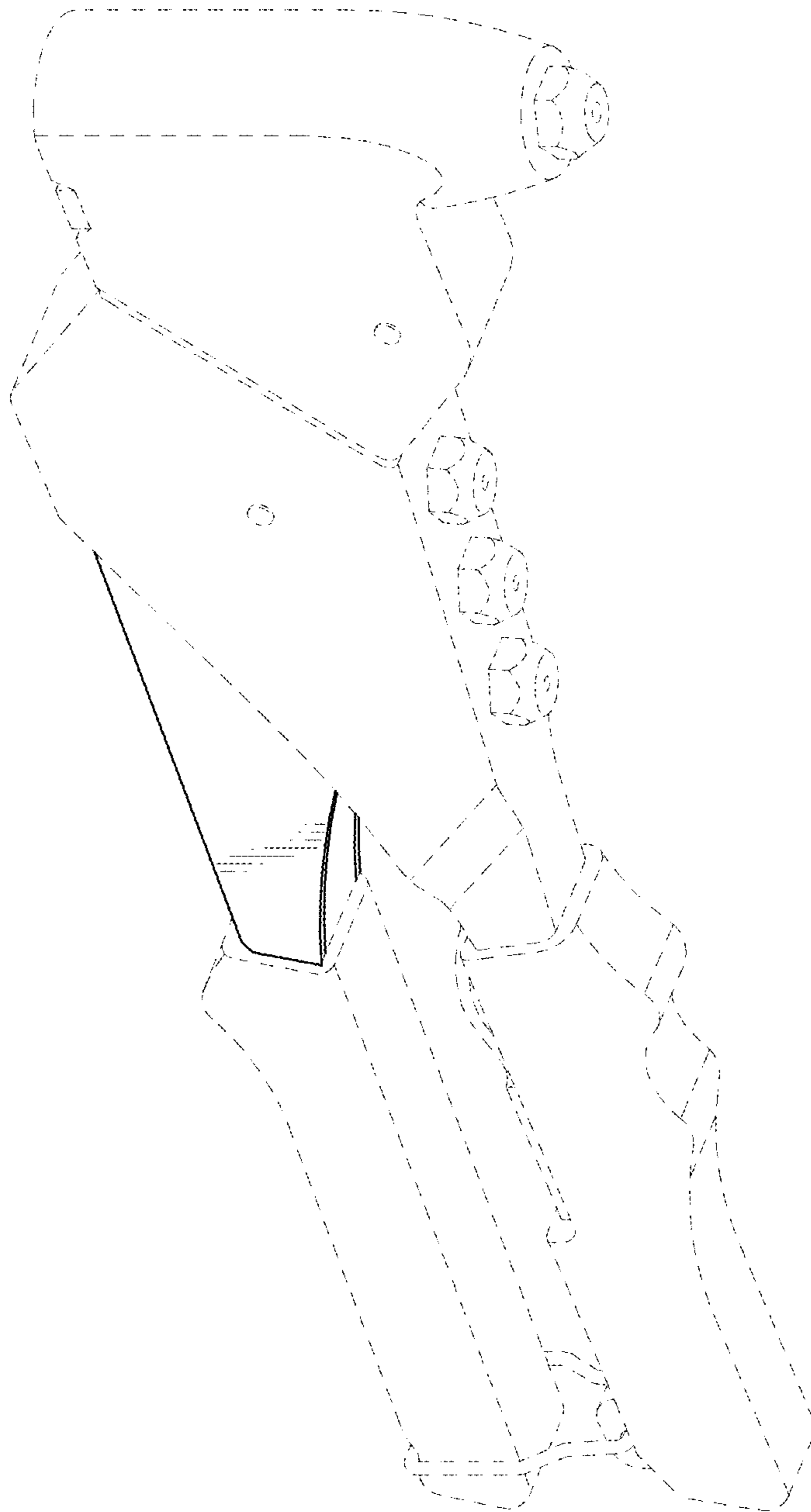

FIG.32