



US00D700395S

(12) **United States Design Patent**  
**Cavaliere et al.**

(10) **Patent No.:** **US D700,395 S**  
(45) **Date of Patent:** **\*\* Feb. 25, 2014**

(54) **LED LINE FIXTURE**

(75) Inventors: **David Cavaliere**, Montreal (CA);  
**Matthieu Fossati**, Montreal (CA);  
**Catalin Dumitrascu**, Laval (CA)

(73) Assignee: **Lumenpulse Lighting, Inc.** (CA)

(\*\*) Term: **14 Years**

(21) Appl. No.: **29/420,263**

(22) Filed: **May 7, 2012**

(51) **LOC (10) Cl.** ..... **26-99**

(52) **U.S. Cl.**  
USPC ..... **D26/142**

(58) **Field of Classification Search**

USPC ..... D26/25, 26, 28, 31, 35, 36, 37, 41, 42,  
D26/50, 51, 52, 64, 66, 67, 73, 75, 78, 85,  
D26/88, 89, 90, 103–106, 109, 110, 119,  
D26/123, 125, 129, 131, 135, 136, 138, 140,  
D26/143, 144; D13/179, 180; 362/92, 130,  
362/132, 133, 183, 184, 190, 205, 216,  
362/217.05, 218, 220, 223, 224, 241, 247,  
362/249.03, 249.05–249.1, 249.11, 258,  
362/260, 285, 287, 294.02, 297, 327, 345,  
362/354, 373–379, 410, 418, 419, 510, 516,  
362/558, 561; 248/339, 557, 558; D8/354,  
D8/373, 377, 382; D25/60, 119, 124, 125;  
52/455; 349/59–62, 64–67, 113;  
438/15; 345/102; D12/406; D10/111,  
D10/114.1; D11/121, 125, 144, 145;  
428/11; 257/96, 97, 98, 99

See application file for complete search history.

(56) **References Cited**

**U.S. PATENT DOCUMENTS**

D616,566 S \* 5/2010 Desrosiers et al. .... D25/60  
D616,567 S \* 5/2010 Desrosiers et al. .... D25/60  
D616,568 S \* 5/2010 Desrosiers et al. .... D25/60  
D621,091 S \* 8/2010 Klu ..... D26/138  
D621,542 S \* 8/2010 Klus ..... D26/138  
D623,342 S \* 9/2010 Klu ..... D26/138

D649,687 S \* 11/2011 Trzesniowski ..... D26/138  
D652,568 S \* 1/2012 Trzesniowski ..... D26/138  
D663,068 S \* 7/2012 Hochman ..... D26/138

\* cited by examiner

*Primary Examiner* — Zenia Bennett

(74) *Attorney, Agent, or Firm* — Pierce Atwood LLP; Joseph M. Maraia

(57) **CLAIM**

The ornamental design for a LED line fixture, as shown and described.

**DESCRIPTION**

FIG. 1 is an end plan view of an embodiment of an LED line fixture;  
FIG. 2 is a top plan view of the LED line fixture of FIG. 1;  
FIG. 3 is a side plan view of the LED line fixture of FIG. 1;  
FIG. 4 is a bottom plan view of the LED line fixture of FIG. 1;  
FIG. 5 is an end plan view of another embodiment of an LED line fixture;  
FIG. 6 is a top plan view of the LED line fixture of FIG. 5;  
FIG. 7 is a side plan view of the LED line fixture of FIG. 5;  
FIG. 8 is a bottom plan view of the LED line fixture of FIG. 5;  
FIG. 9 is an end plan view of another embodiment of an LED line fixture;  
FIG. 10 is a top plan view of the LED line fixture of FIG. 9;  
FIG. 11 is a side plan view of the LED line fixture of FIG. 9;  
FIG. 12 is a bottom plan view of the LED line fixture of FIG. 9;  
FIG. 13 is an end plan view of another embodiment of an LED line fixture;  
FIG. 14 is a top plan view of the LED line fixture of FIG. 13;  
FIG. 15 is a side plan view of the LED line fixture of FIG. 13;  
FIG. 16 is a bottom plan view of the LED line fixture of FIG. 13;  
FIG. 17 is an end plan view of another embodiment of an LED line fixture;  
FIG. 18 is a top plan view of the LED line fixture of FIG. 17;  
FIG. 19 is a side plan view of the LED line fixture of FIG. 17;  
FIG. 20 is a bottom plan view of the LED line fixture of FIG. 17;

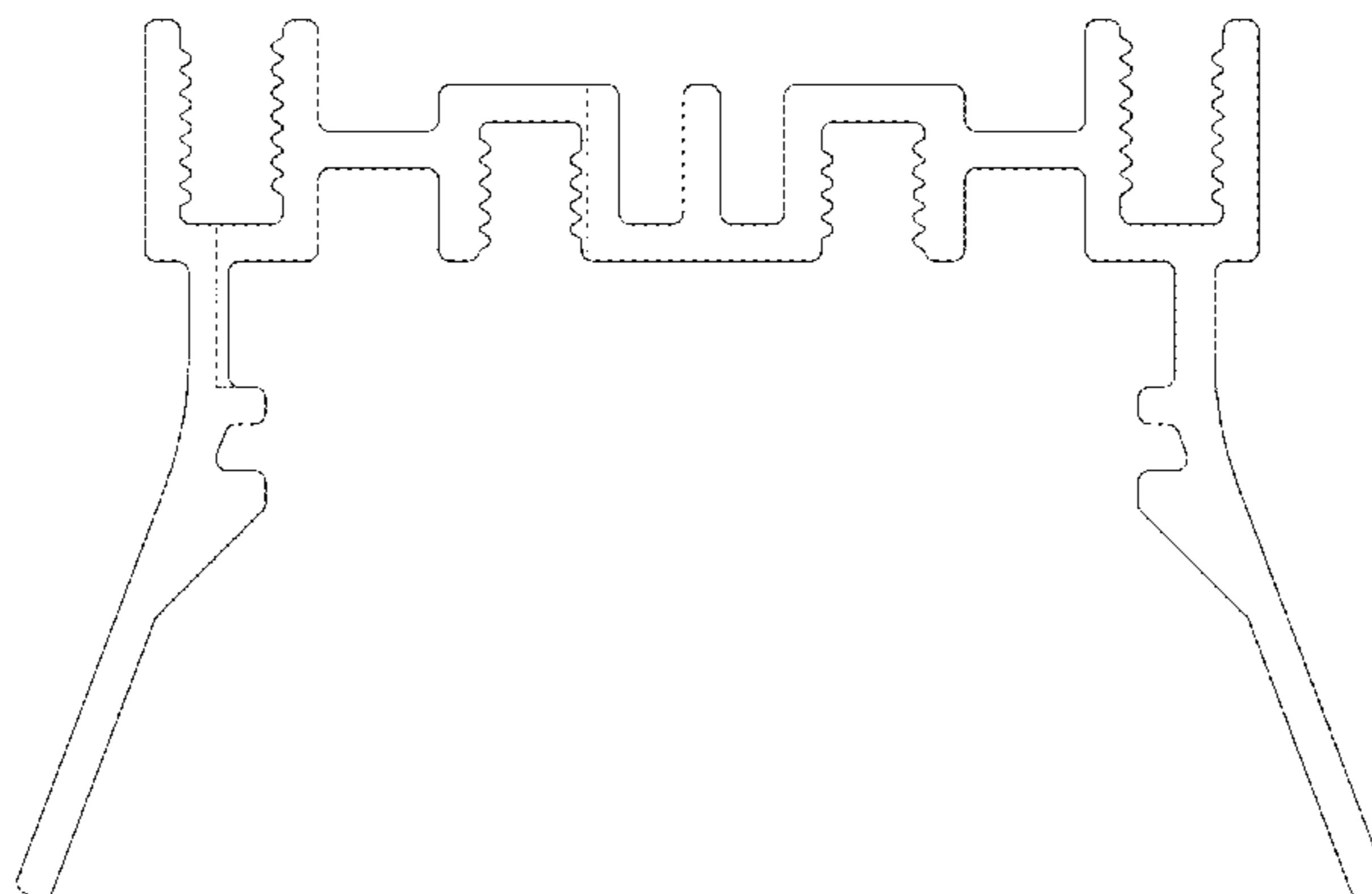

FIG. 21 is an end plan view of another embodiment of an LED line fixture;

FIG. 22 is a top plan view of the LED line fixture of FIG. 21;

FIG. 23 is a side plan view of the LED line fixture of FIG. 21;

FIG. 24 is a bottom plan view of the LED line fixture of FIG. 21;

FIG. 25 is an end plan view of another embodiment of an LED line fixture;

FIG. 26 is a top plan view of the LED line fixture of FIG. 25;

FIG. 27 is a side plan view of the LED line fixture of FIG. 25;

FIG. 28 is a bottom plan view of the LED line fixture of FIG. 25;

FIG. 29 is an end plan view of another embodiment of an LED line fixture;

FIG. 30 is a top plan view of the LED line fixture of FIG. 29;

FIG. 31 is a side plan view of the LED line fixture of FIG. 29;

FIG. 32 is a bottom plan view of the LED line fixture of FIG. 29;

FIG. 33 is an end plan view of another embodiment of an LED line fixture;

FIG. 34 is a top plan view of the LED line fixture of FIG. 33;

FIG. 35 is a side plan view of the LED line fixture of FIG. 33;

FIG. 36 is a bottom plan view of the LED line fixture of FIG. 33;

FIG. 37 is an end plan view of another embodiment of an LED line fixture;

FIG. 38 is a top plan view of the LED line fixture of FIG. 37;

FIG. 39 is a side plan view of the LED line fixture of FIG. 37;

FIG. 40 is a bottom plan view of the LED line fixture of FIG. 37;

FIG. 41 is an end plan view of another embodiment of an LED line fixture;

FIG. 42 is a top plan view of the LED line fixture of FIG. 41;

FIG. 43 is a side plan view of the LED line fixture of FIG. 41;

FIG. 44 is a bottom plan view of the LED line fixture of FIG. 41;

FIG. 45 is an end plan view of another embodiment of an LED line fixture;

FIG. 46 is a top plan view of the LED line fixture of FIG. 45;

FIG. 47 is a side plan view of the LED line fixture of FIG. 45;

and,

FIG. 48 is a bottom plan view of the LED line fixture of FIG. 45.

The broken lines in the drawing are for illustrative purposes only and form no part of the claimed design.

**1 Claim, 48 Drawing Sheets**

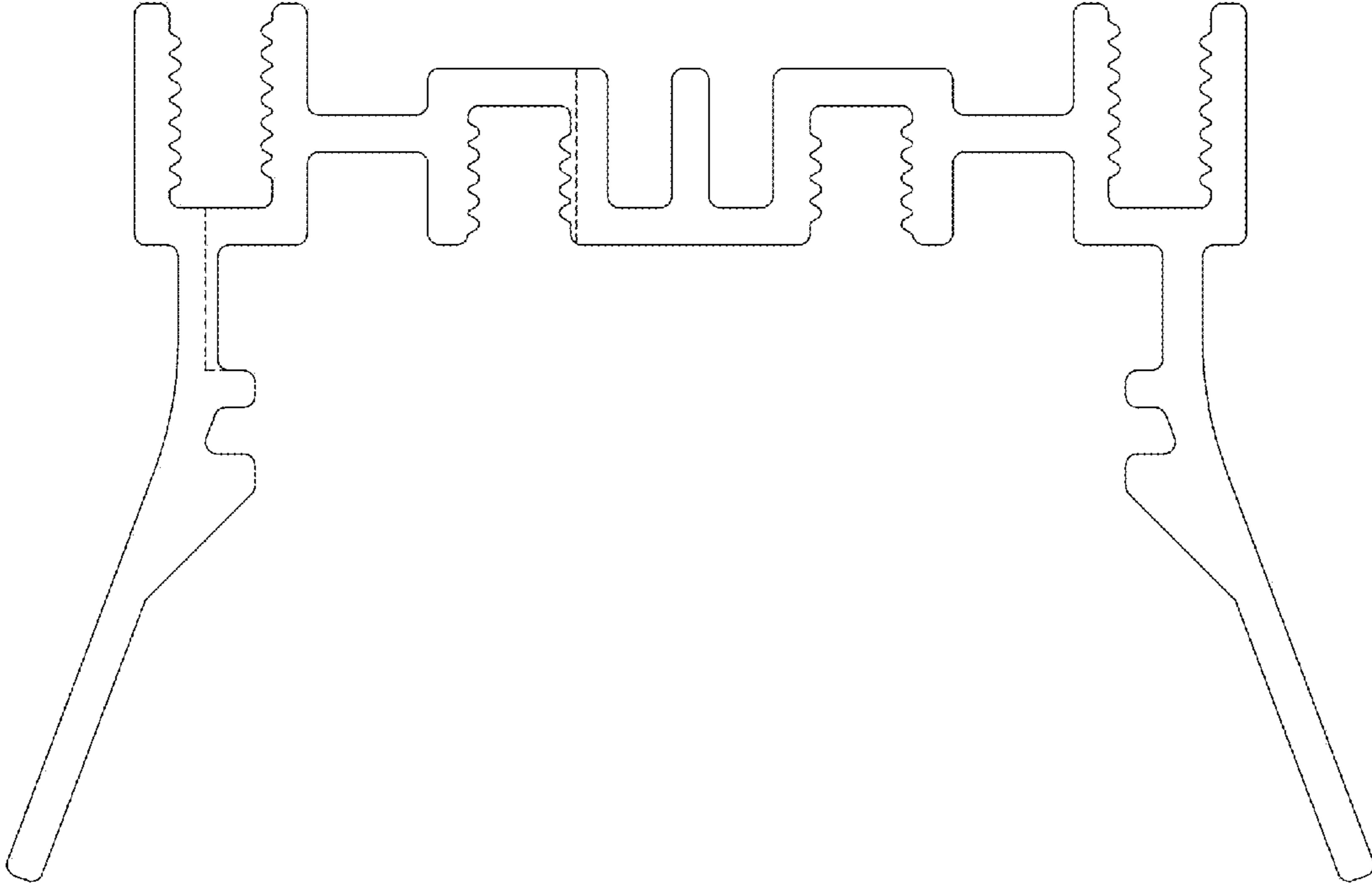

FIG. 1

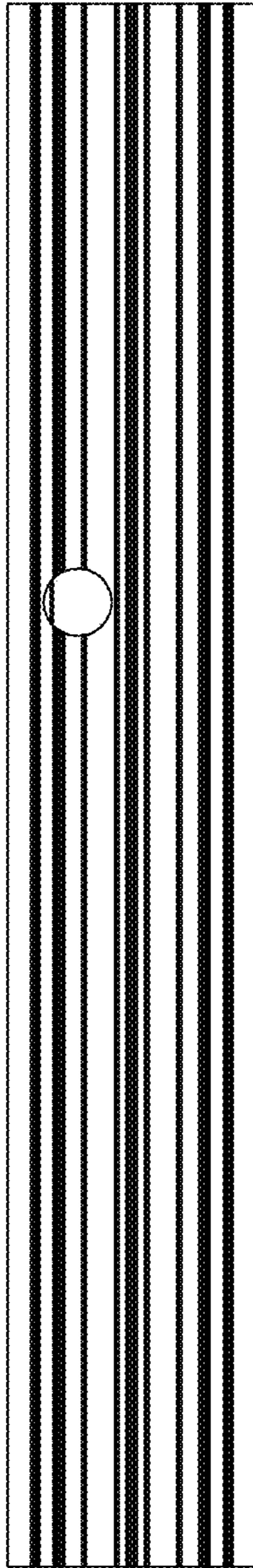

FIG. 2

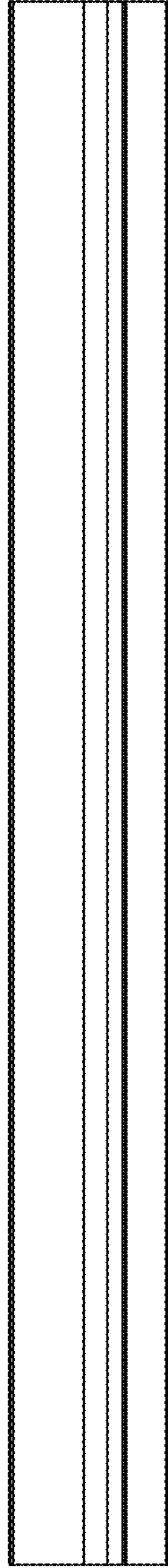

FIG. 3

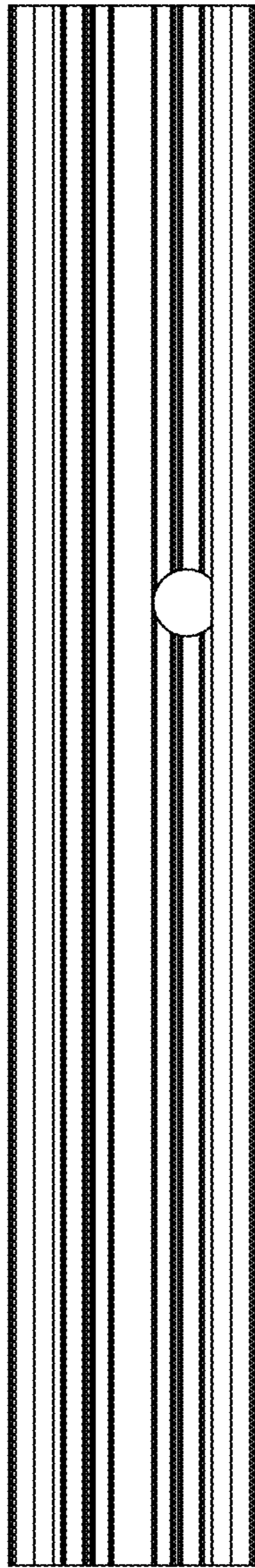

FIG. 4

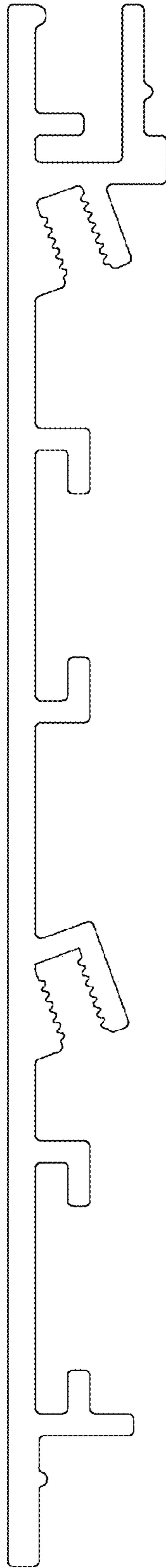

FIG. 5



FIG. 6



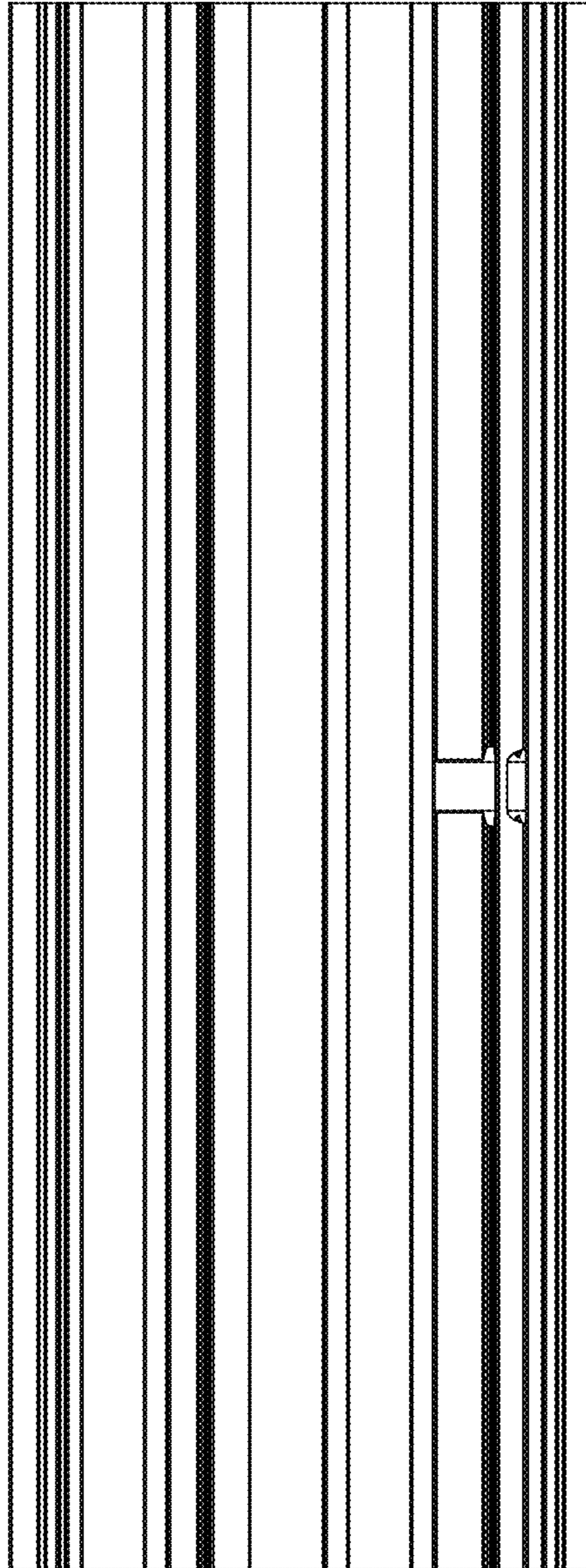

FIG. 7



FIG. 8

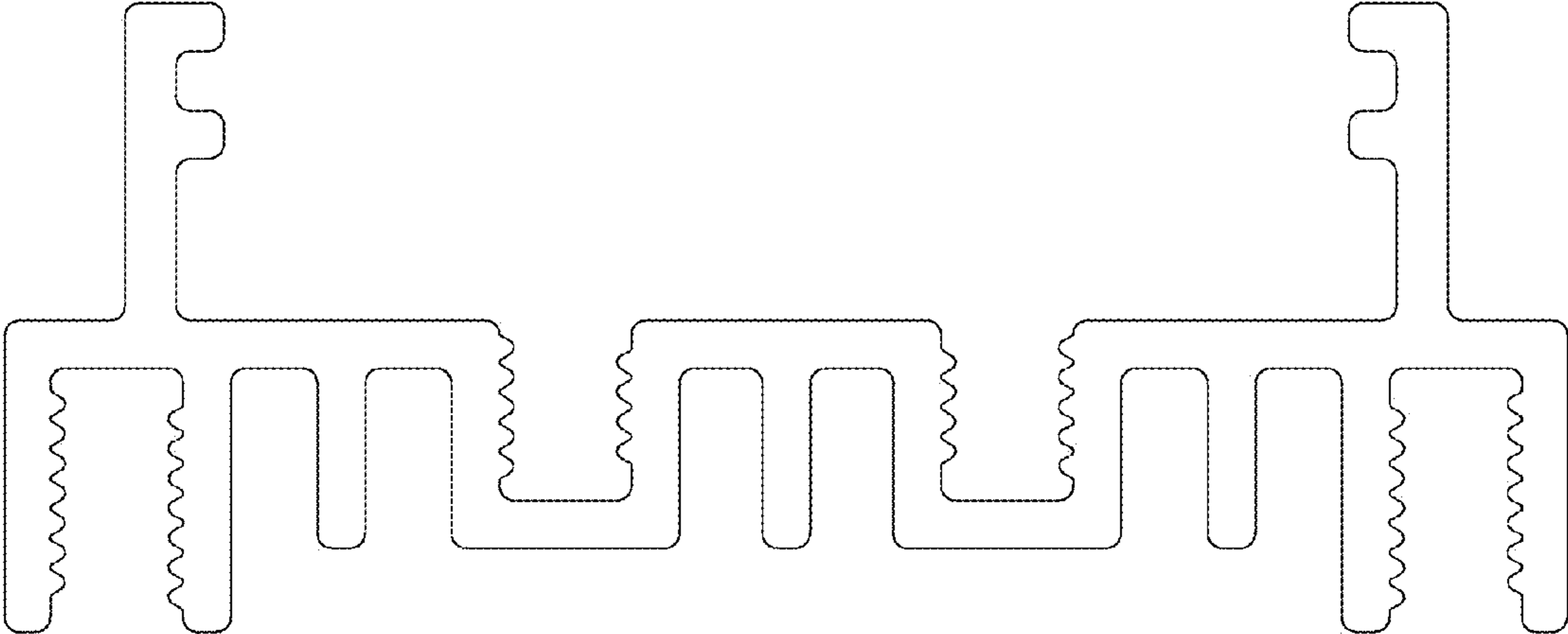

FIG. 9

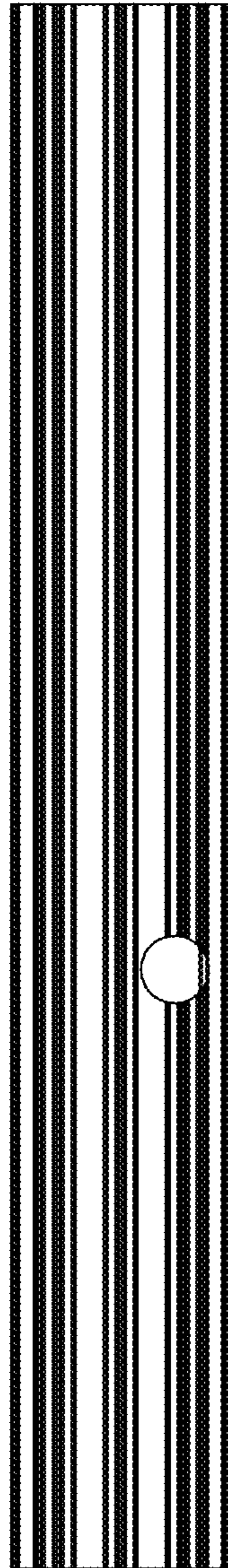

FIG. 10

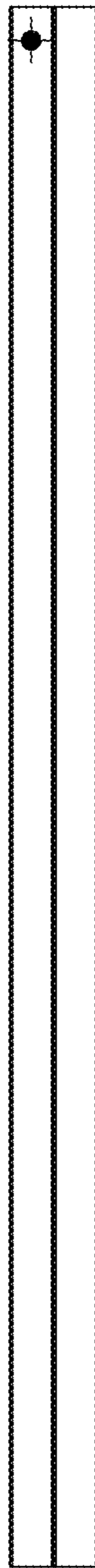

FIG. 11

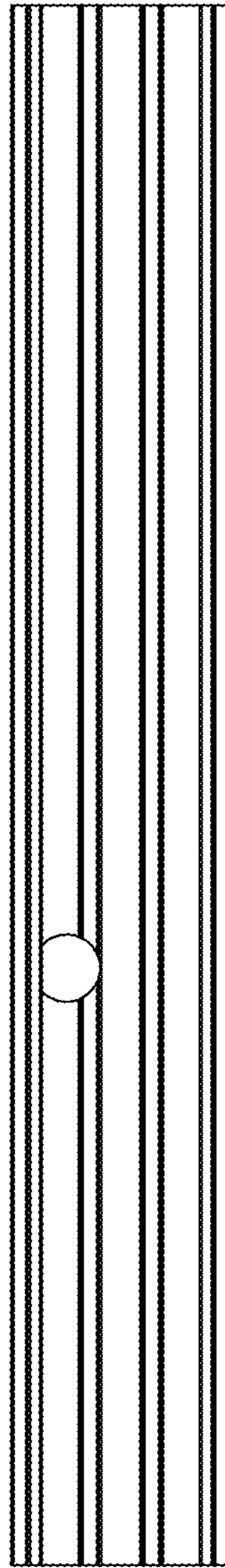

FIG. 12

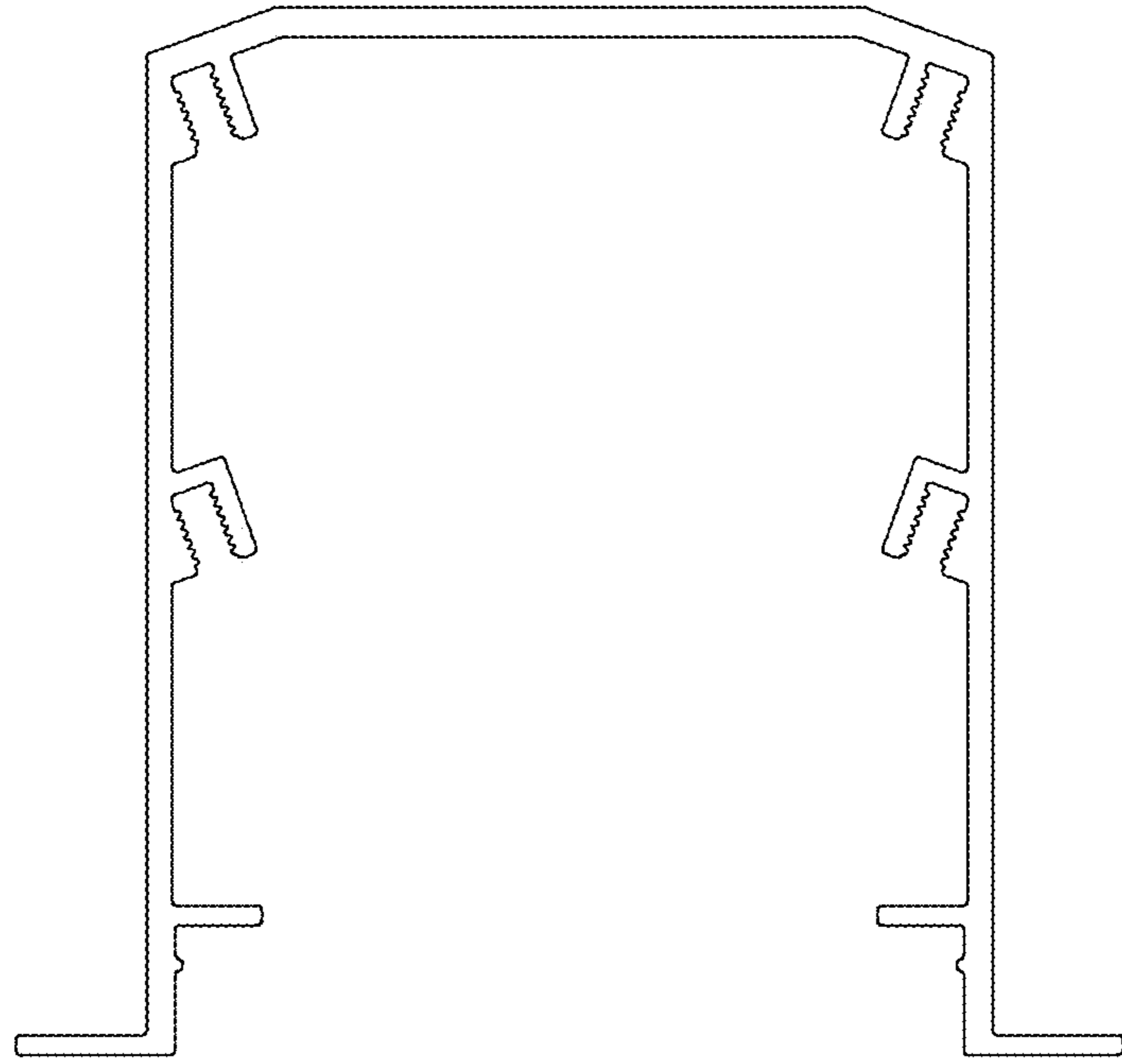

FIG. 13

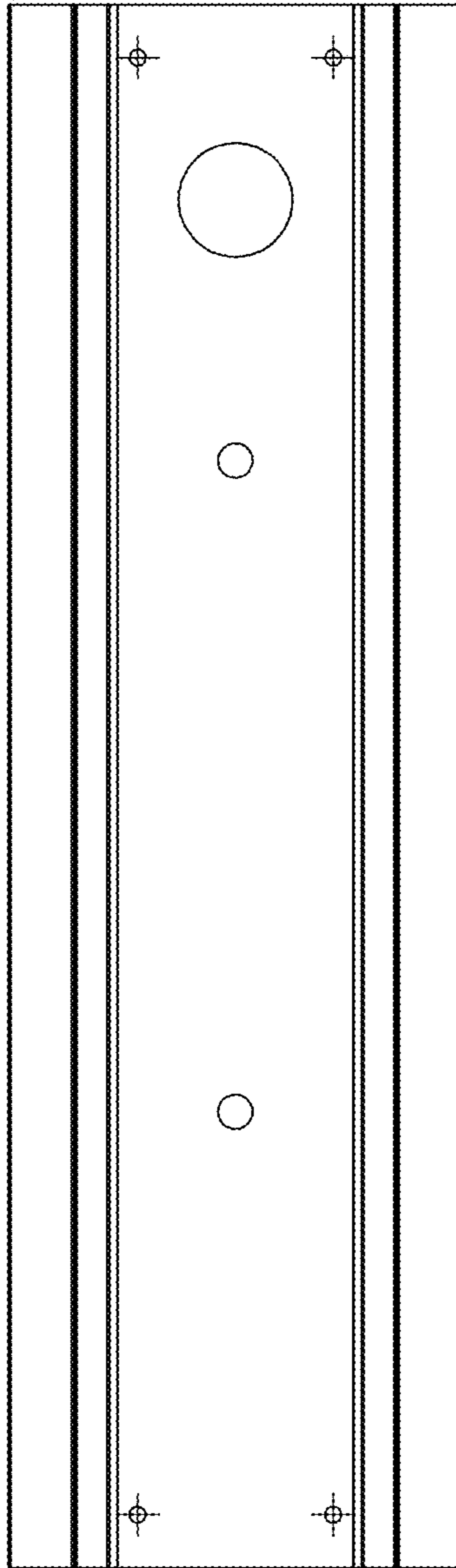

FIG. 14



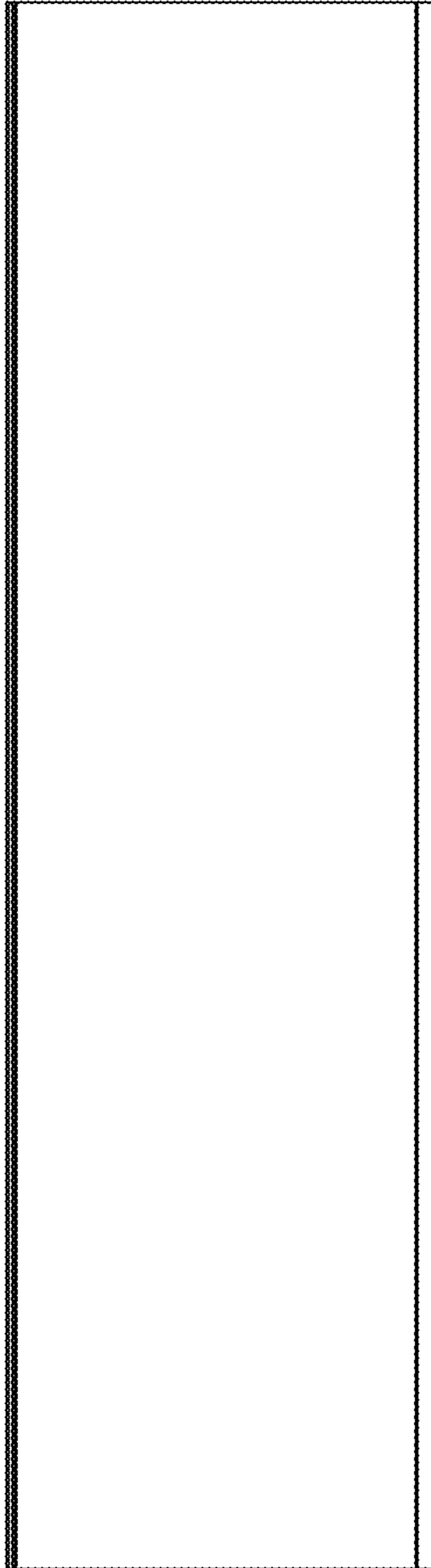

FIG. 15

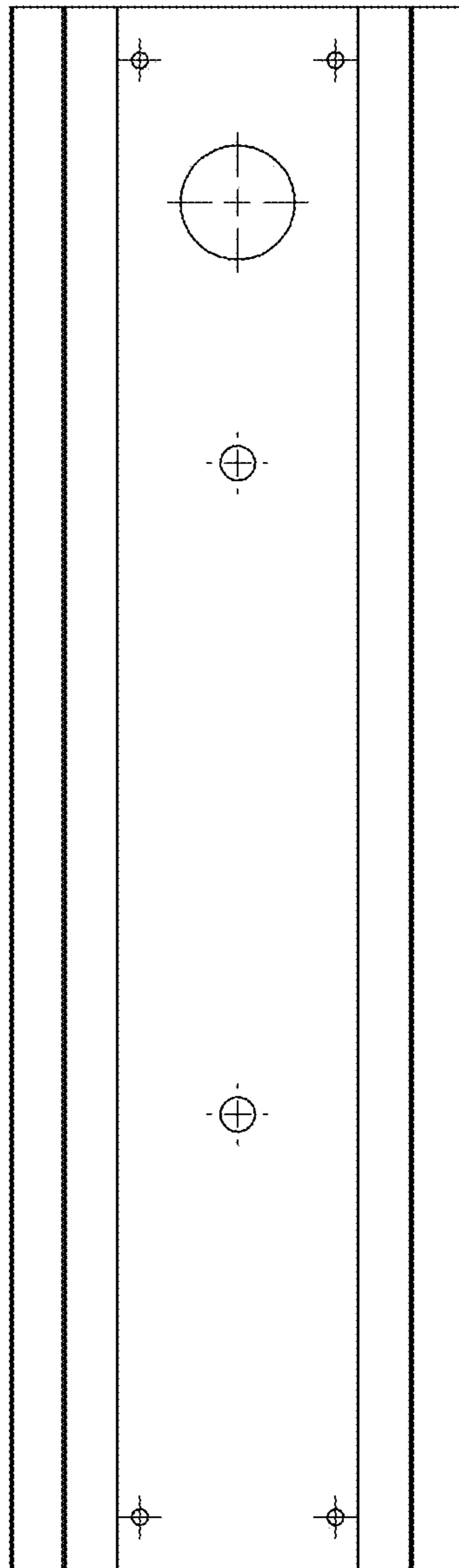

FIG. 16

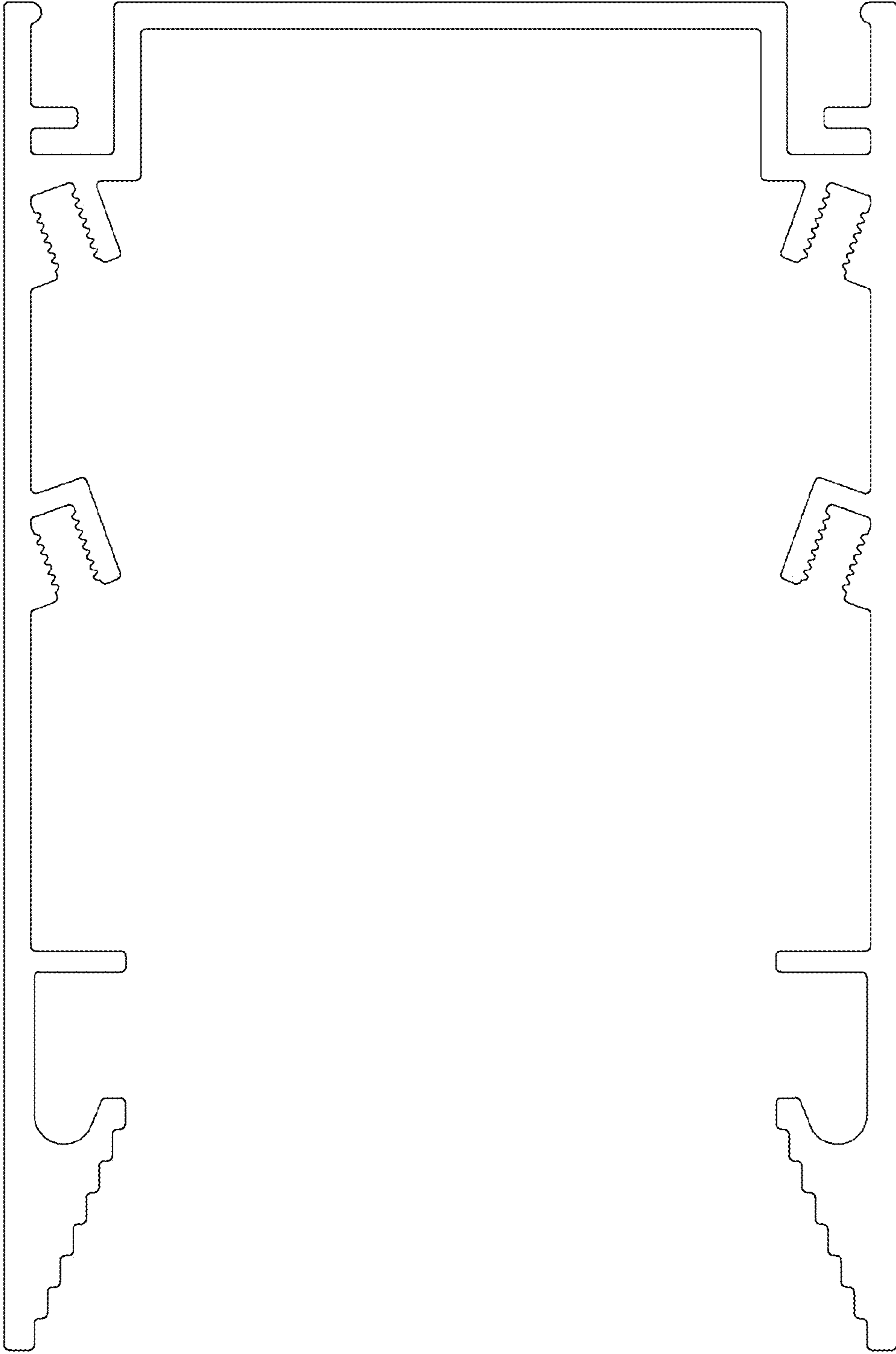

FIG. 17

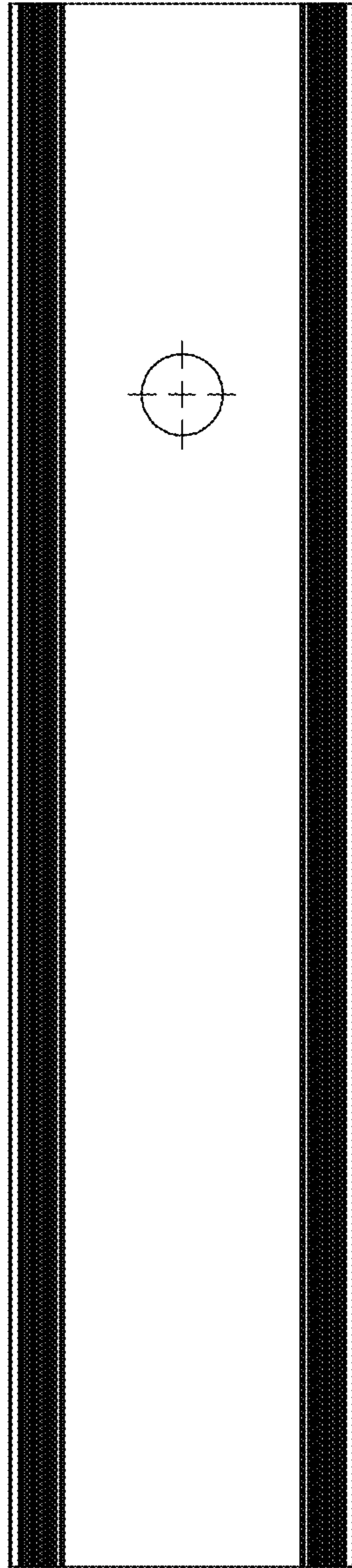
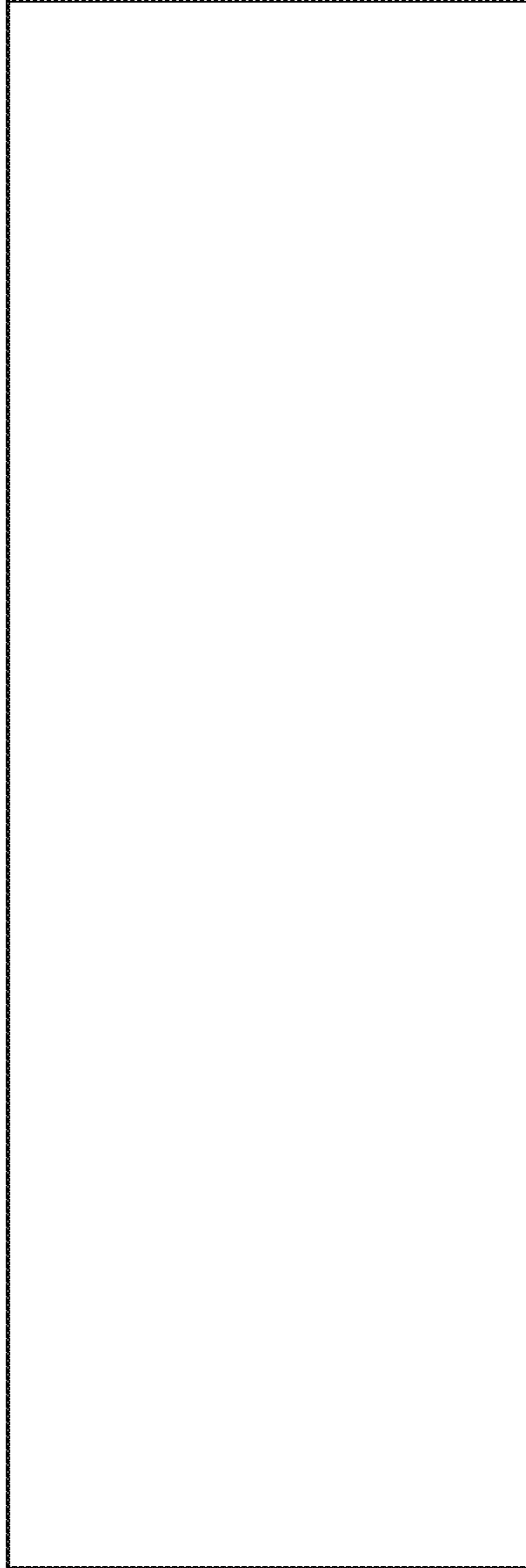

FIG. 18



**FIG. 19**

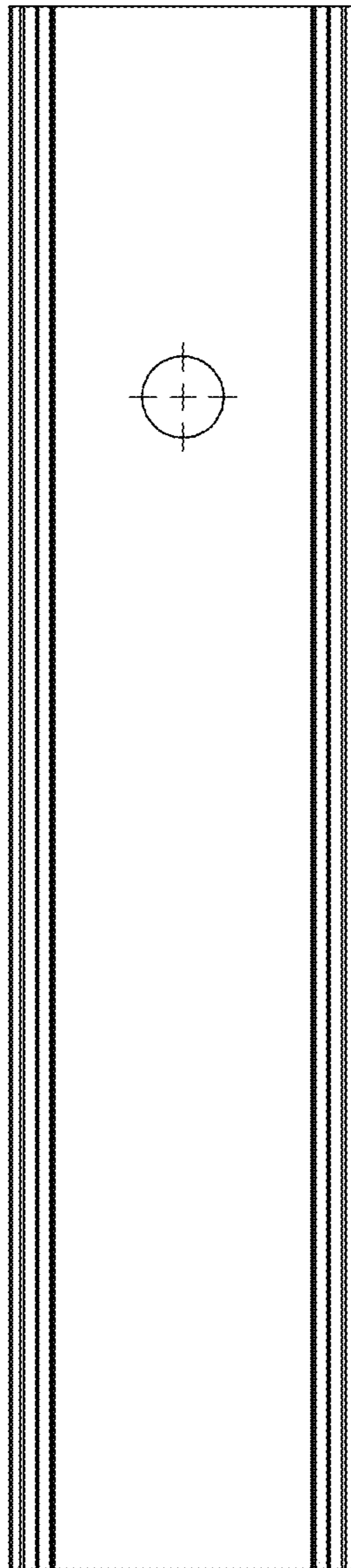

FIG. 20

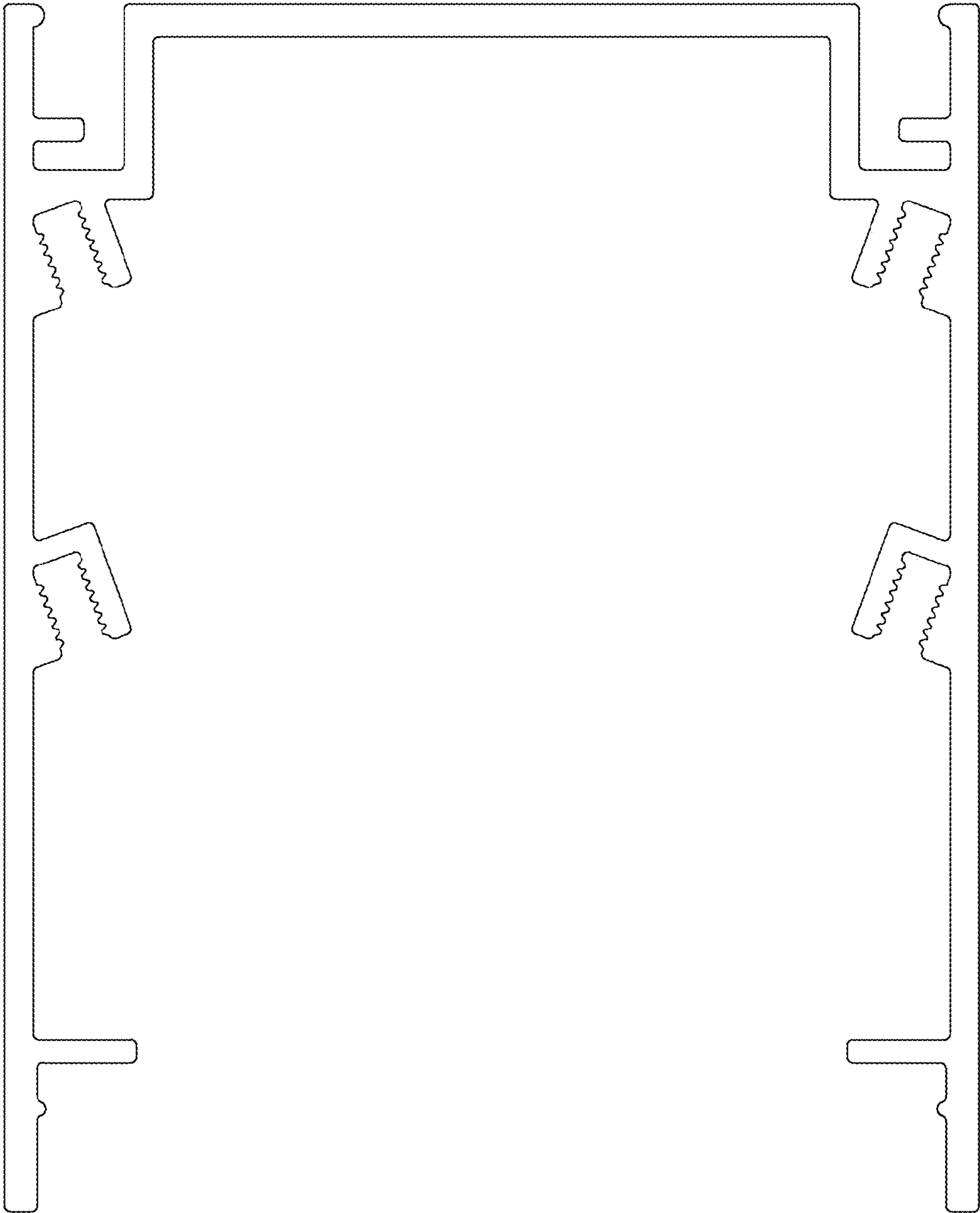

FIG. 21

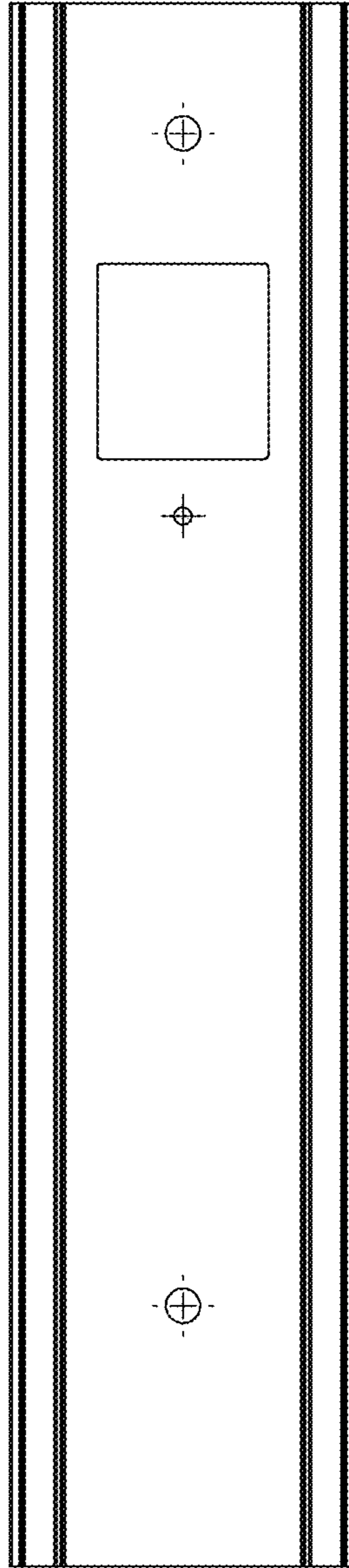

FIG. 22



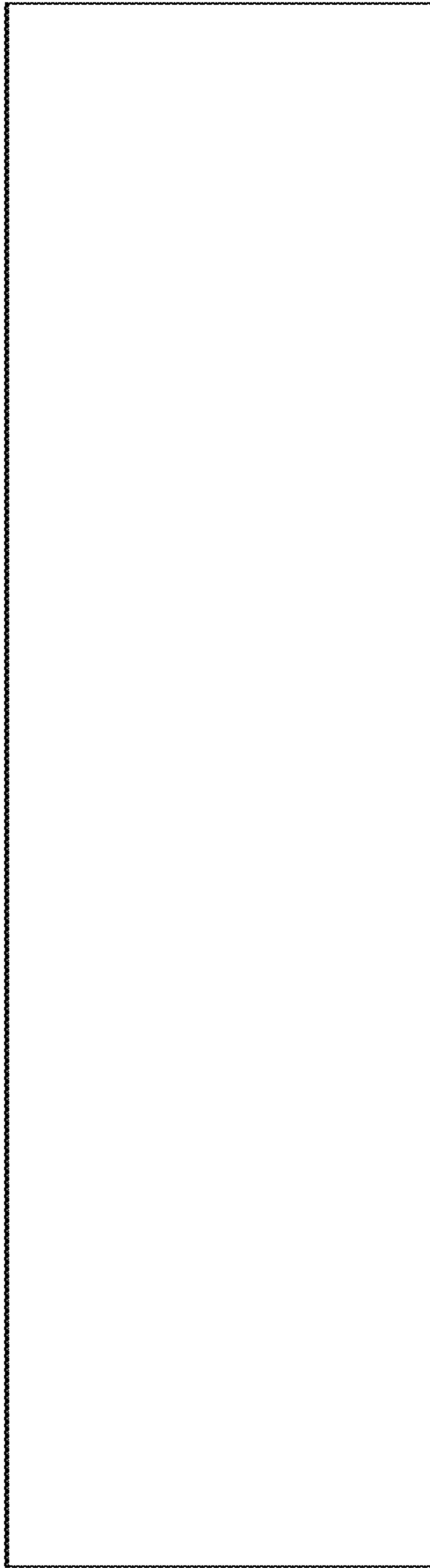

FIG. 23

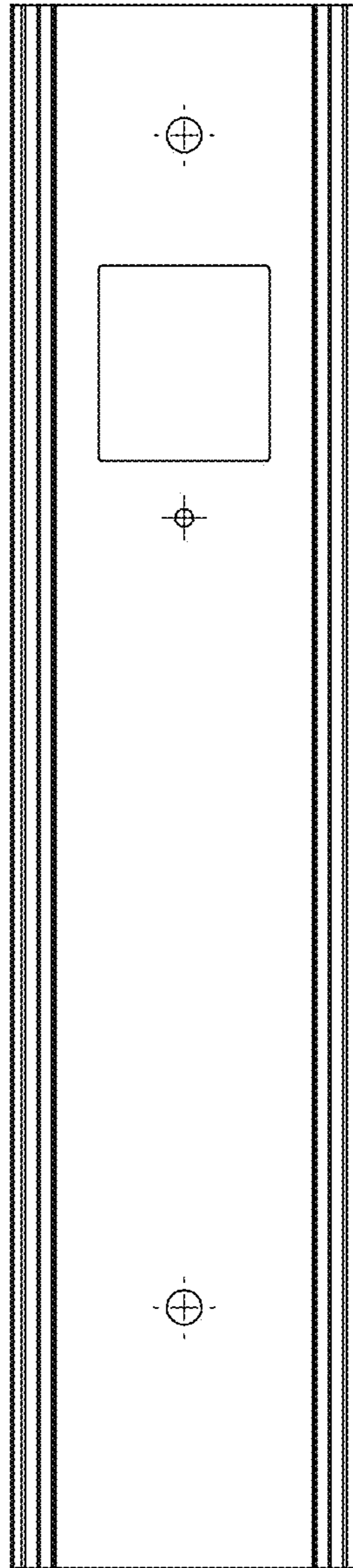

FIG. 24

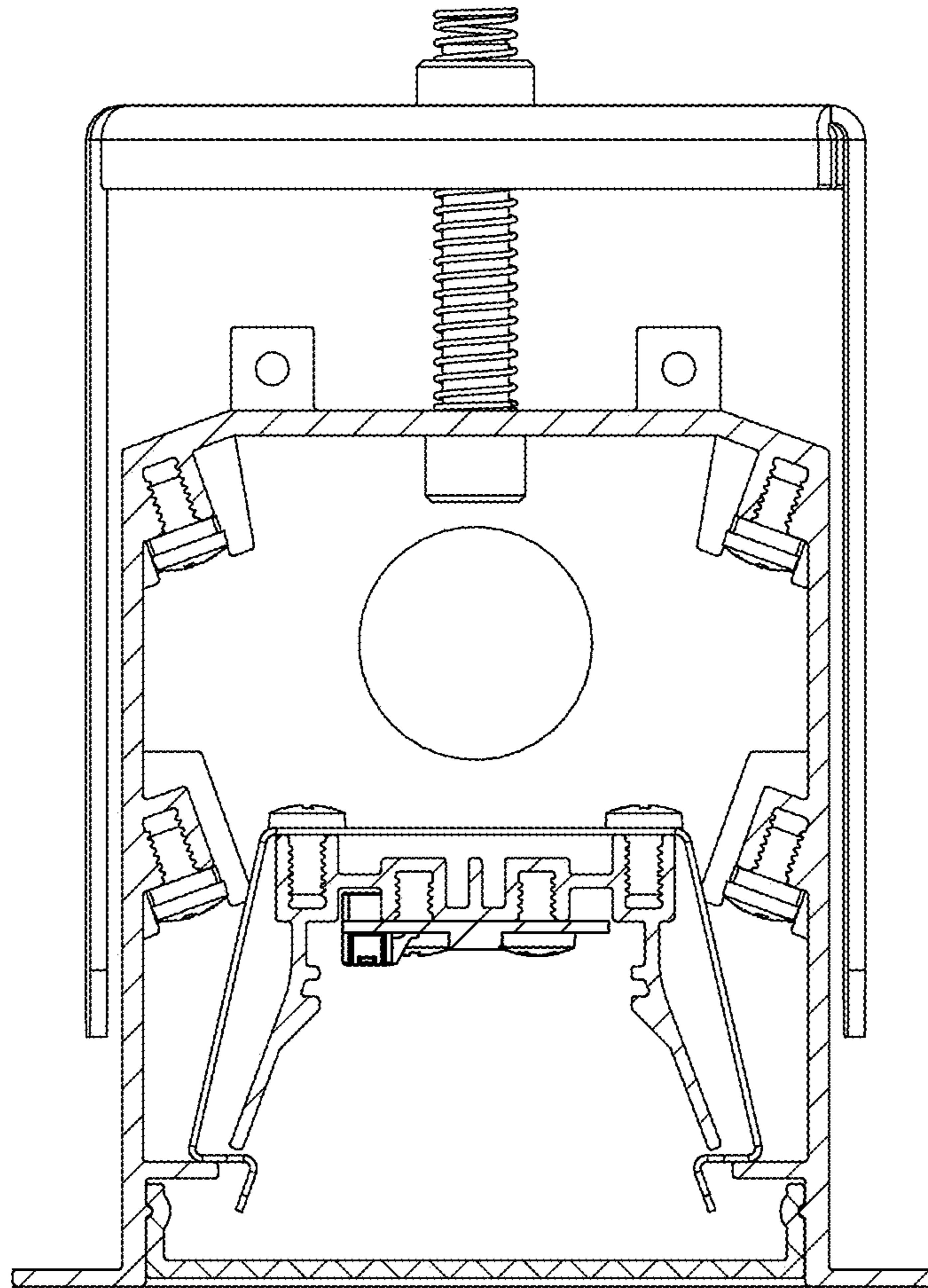

FIG. 25

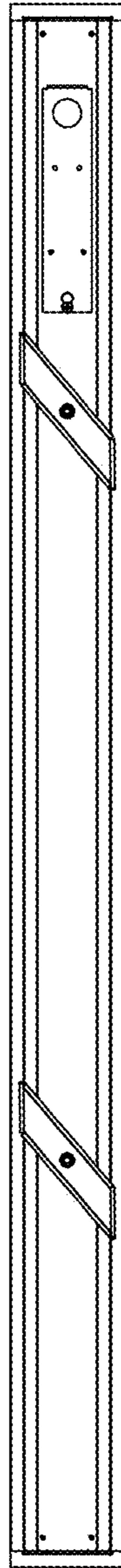

FIG. 26

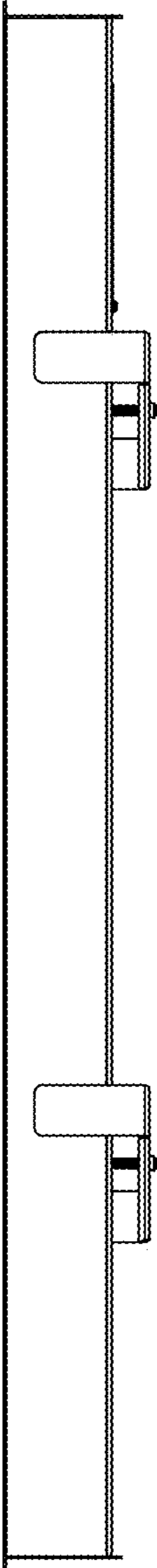

FIG. 27



FIG. 28

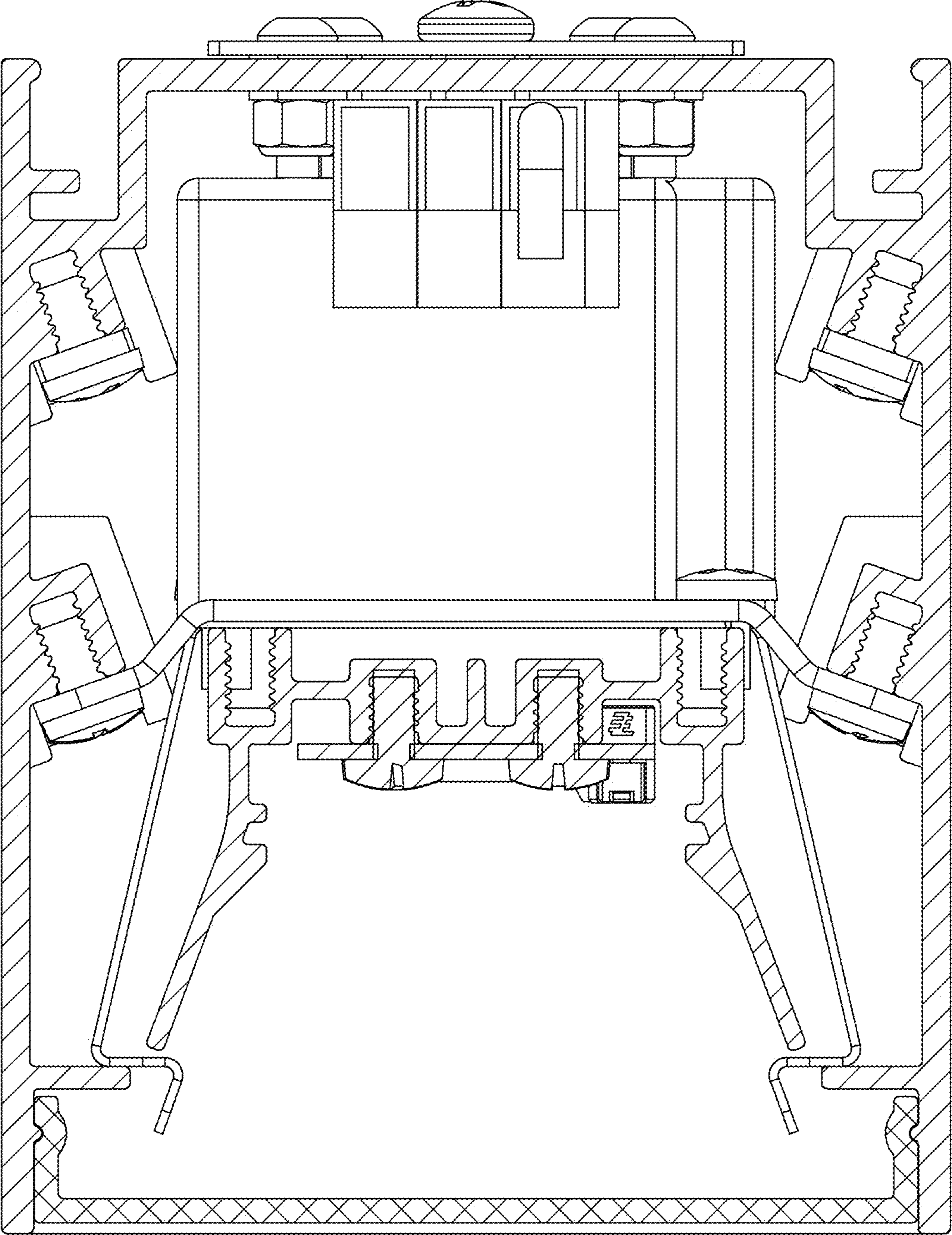

FIG. 29



FIG. 30



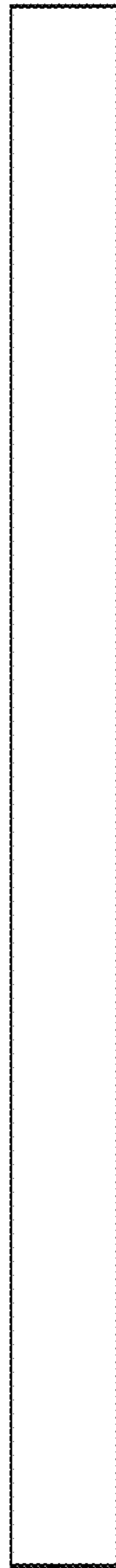

FIG. 31



FIG. 32

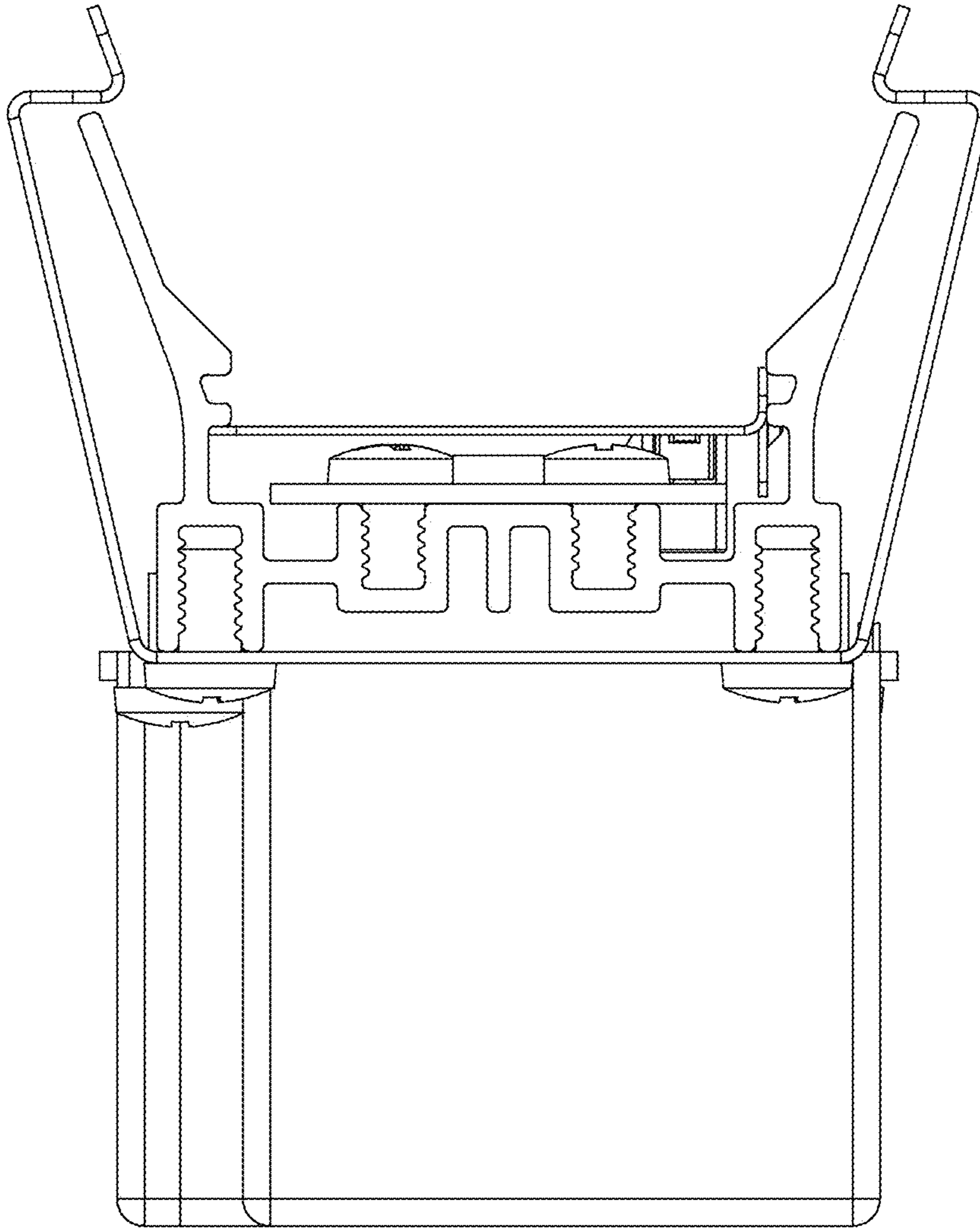

FIG. 33

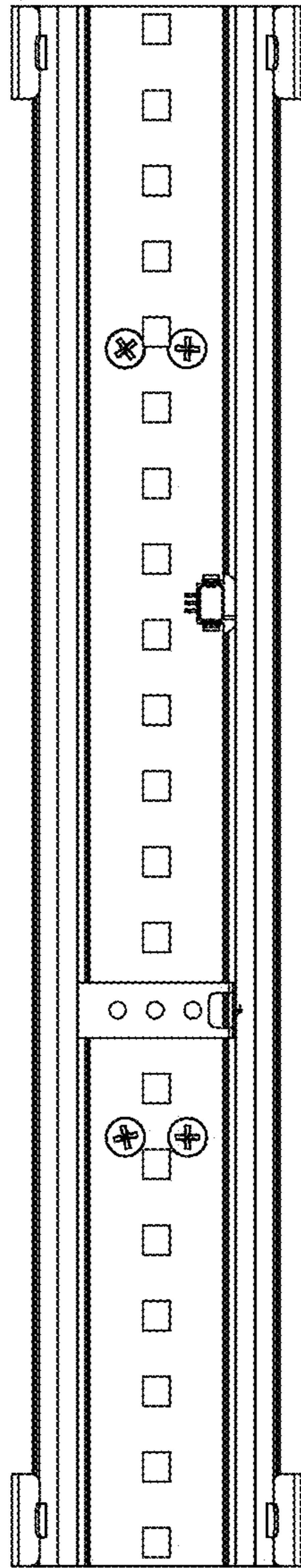

FIG. 34

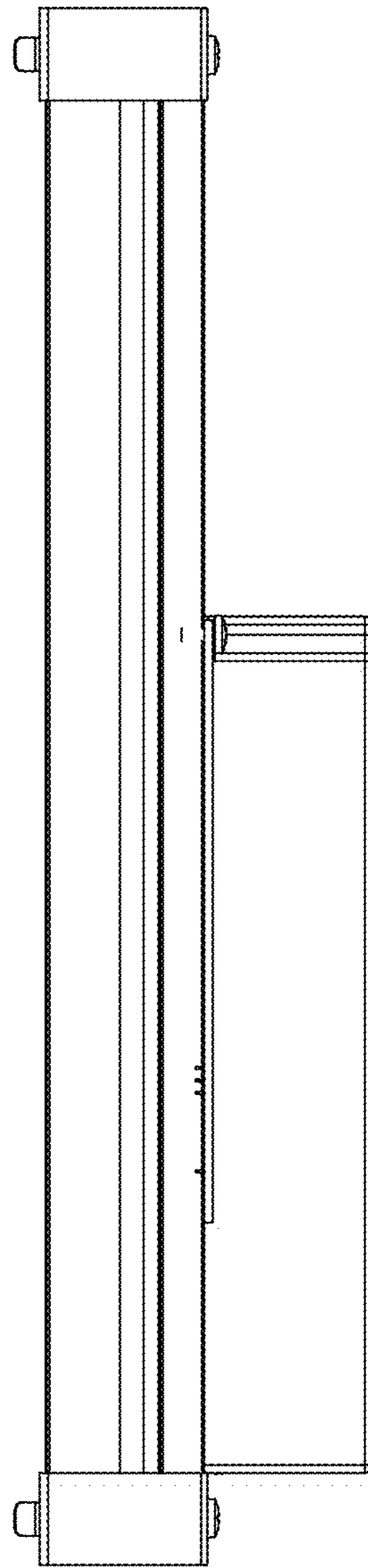

FIG. 35

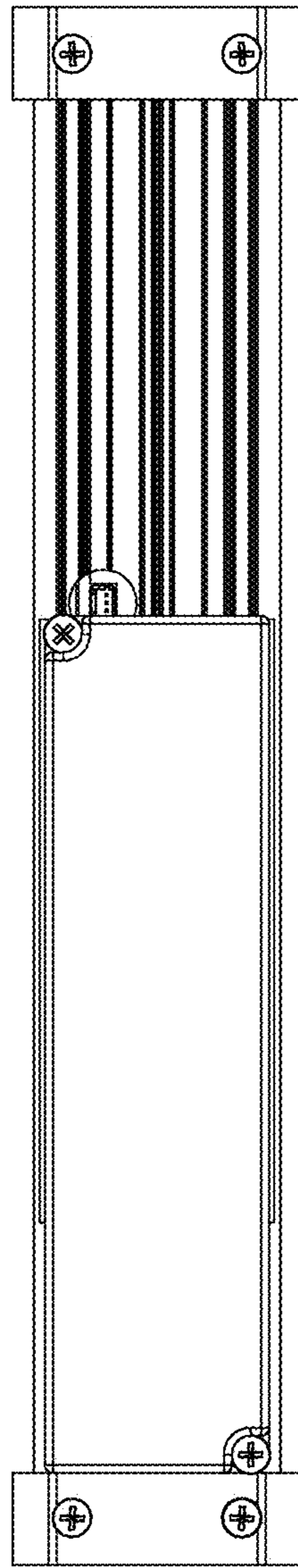

FIG. 36

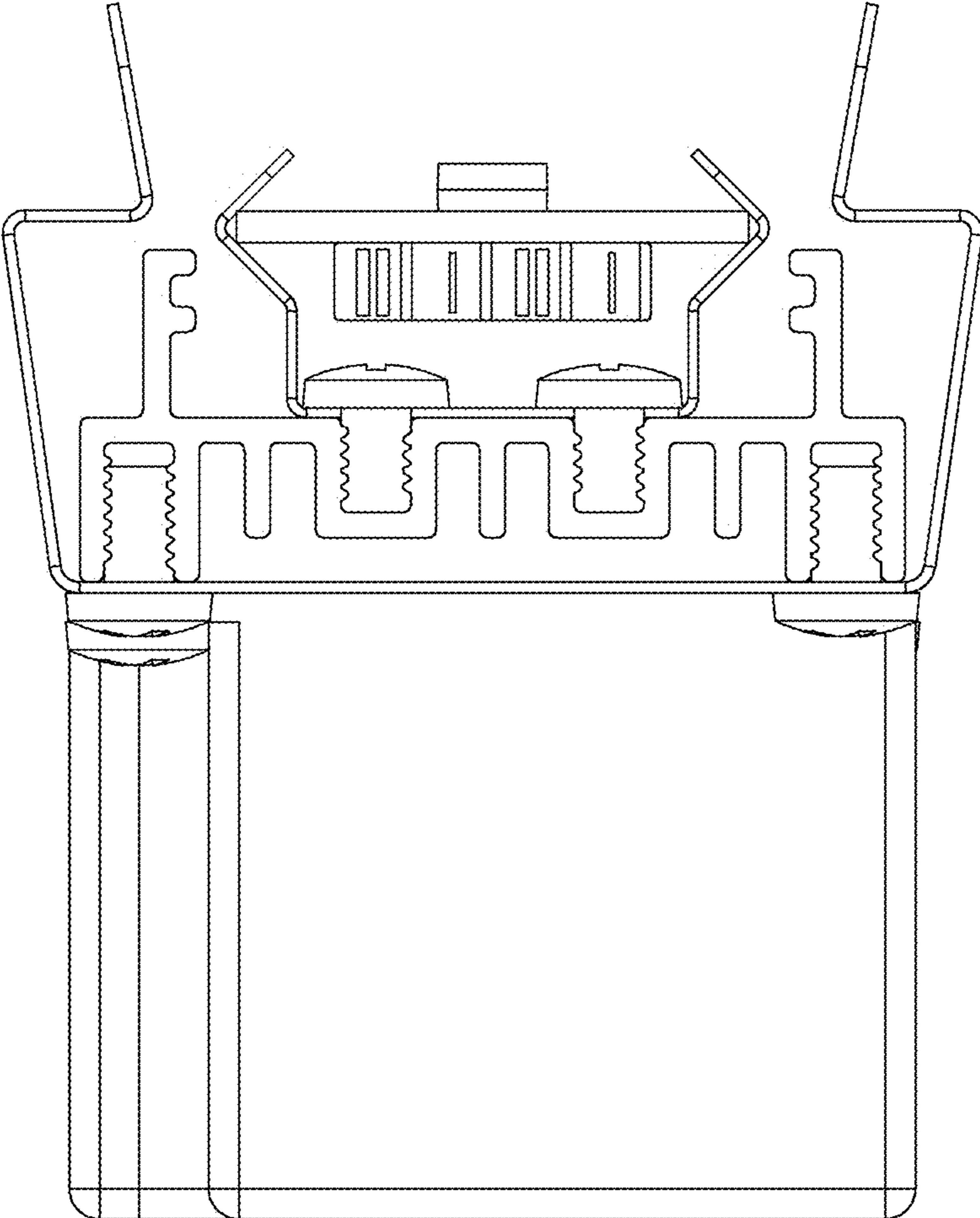

FIG. 37

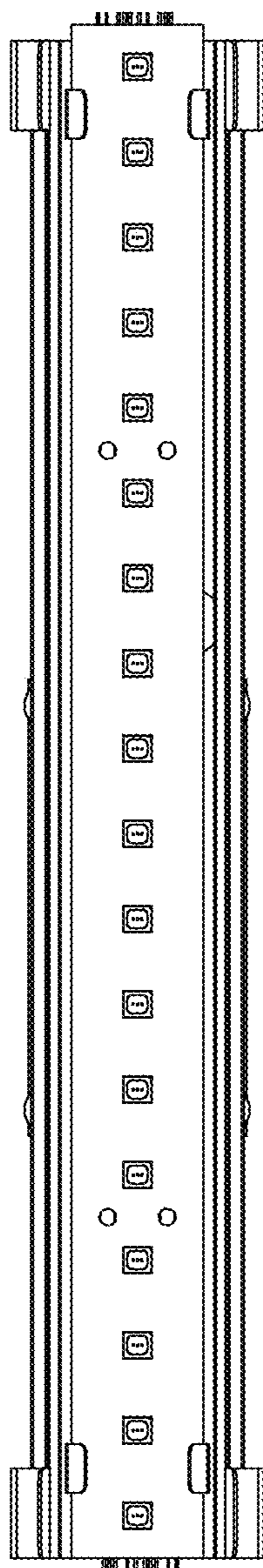

FIG. 38



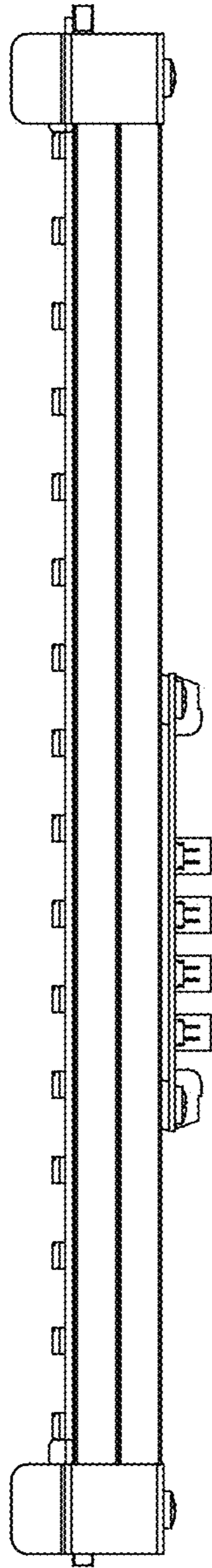

FIG. 39

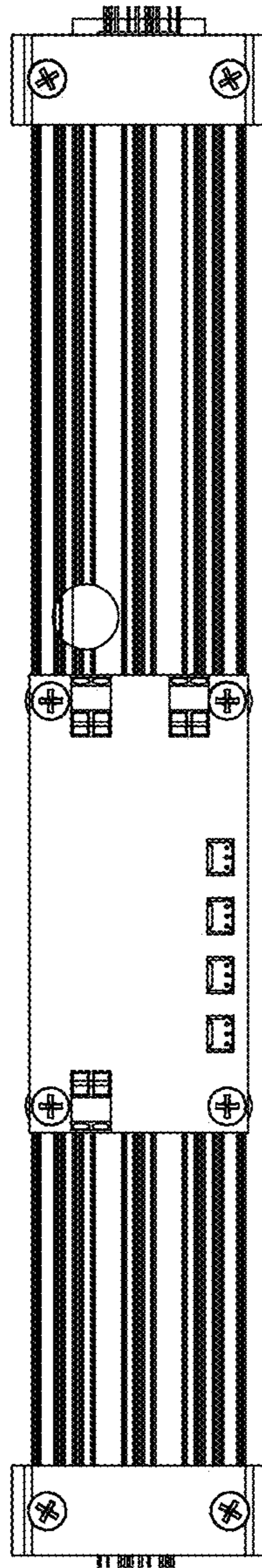

FIG. 40

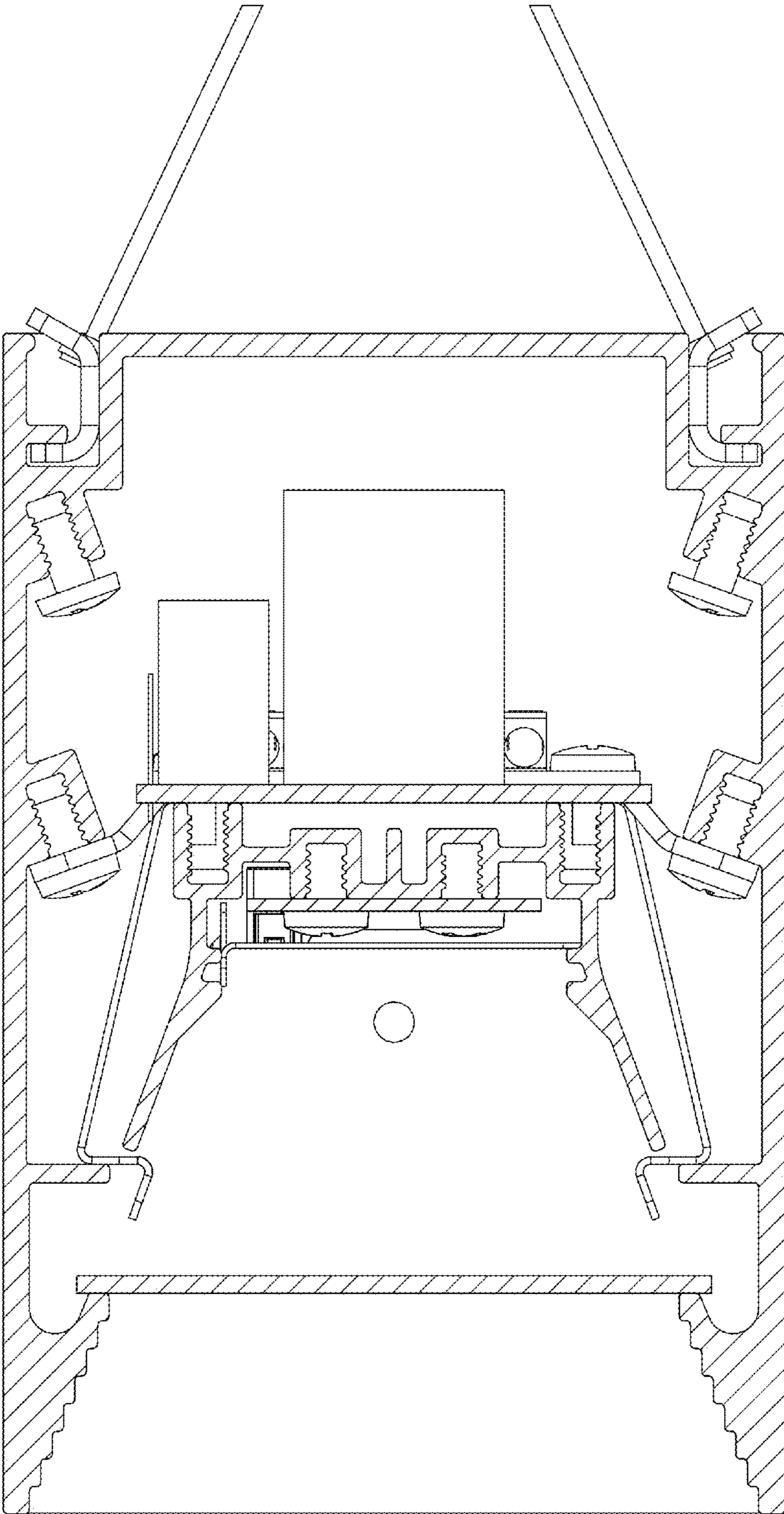

FIG. 41



FIG. 42

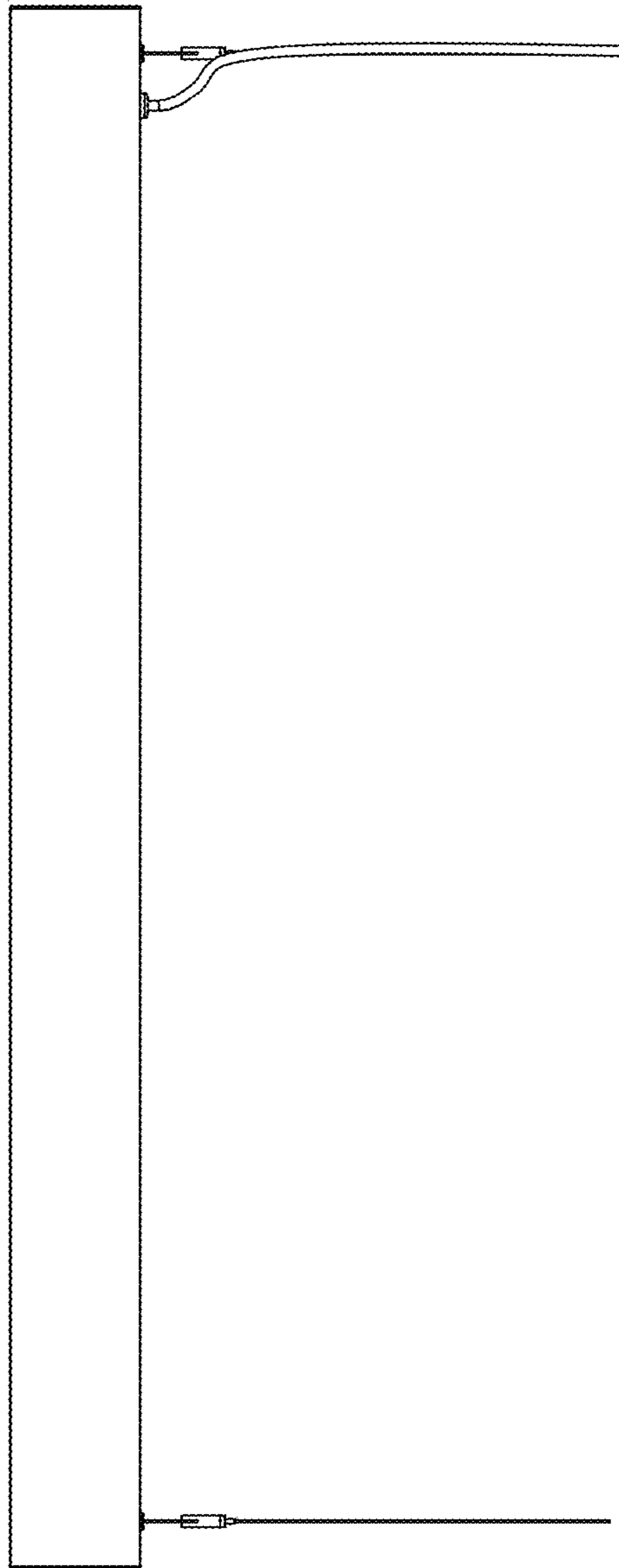

FIG. 43

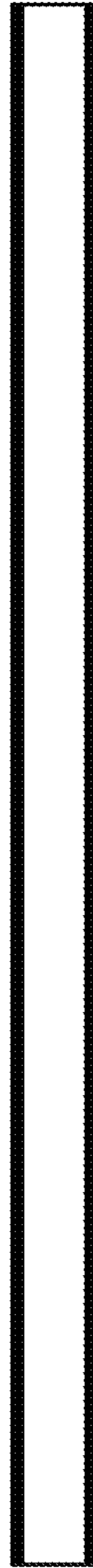

FIG. 44

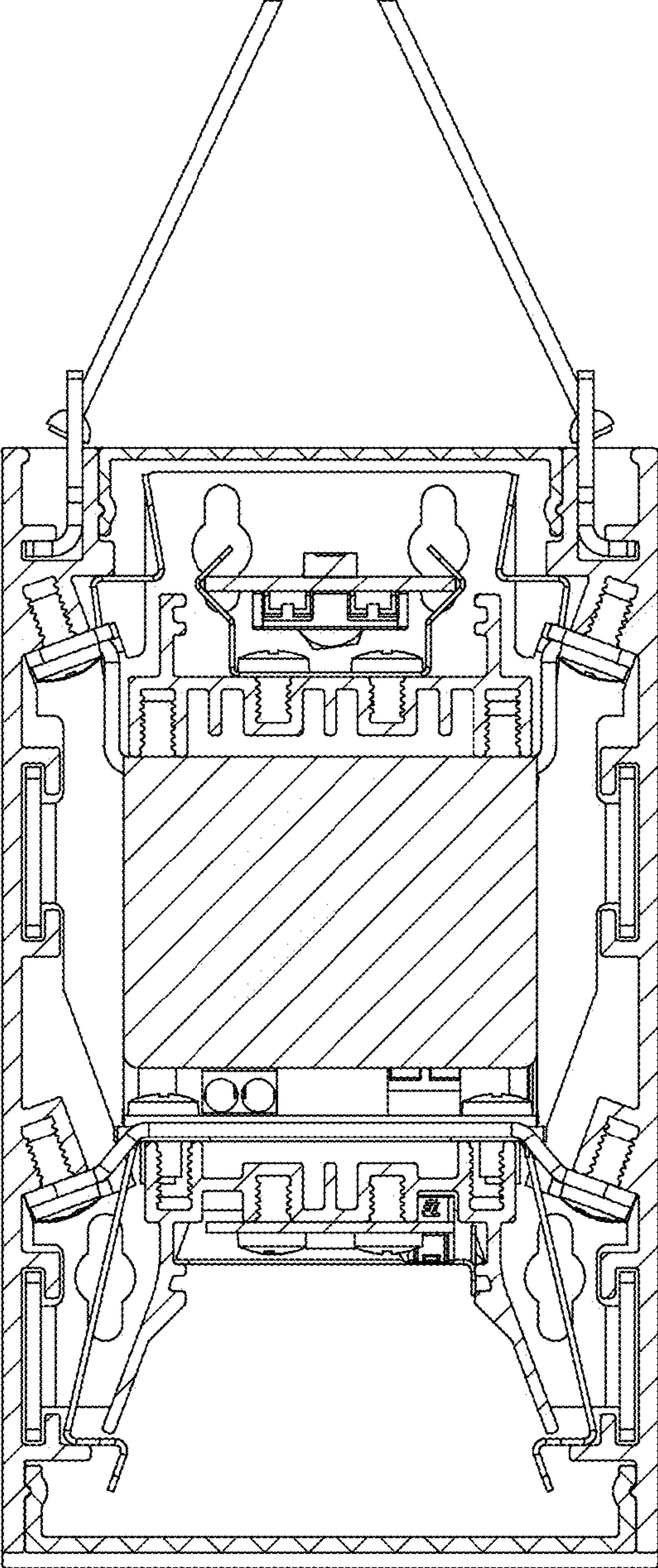

FIG. 45

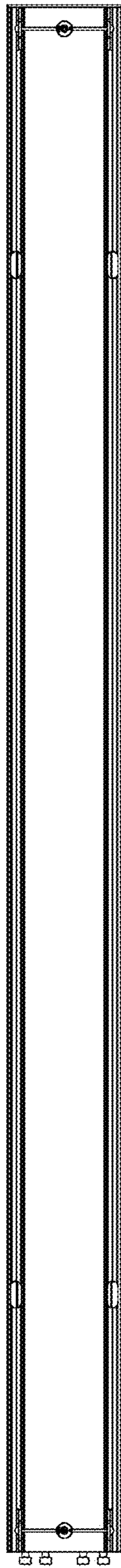

FIG. 46



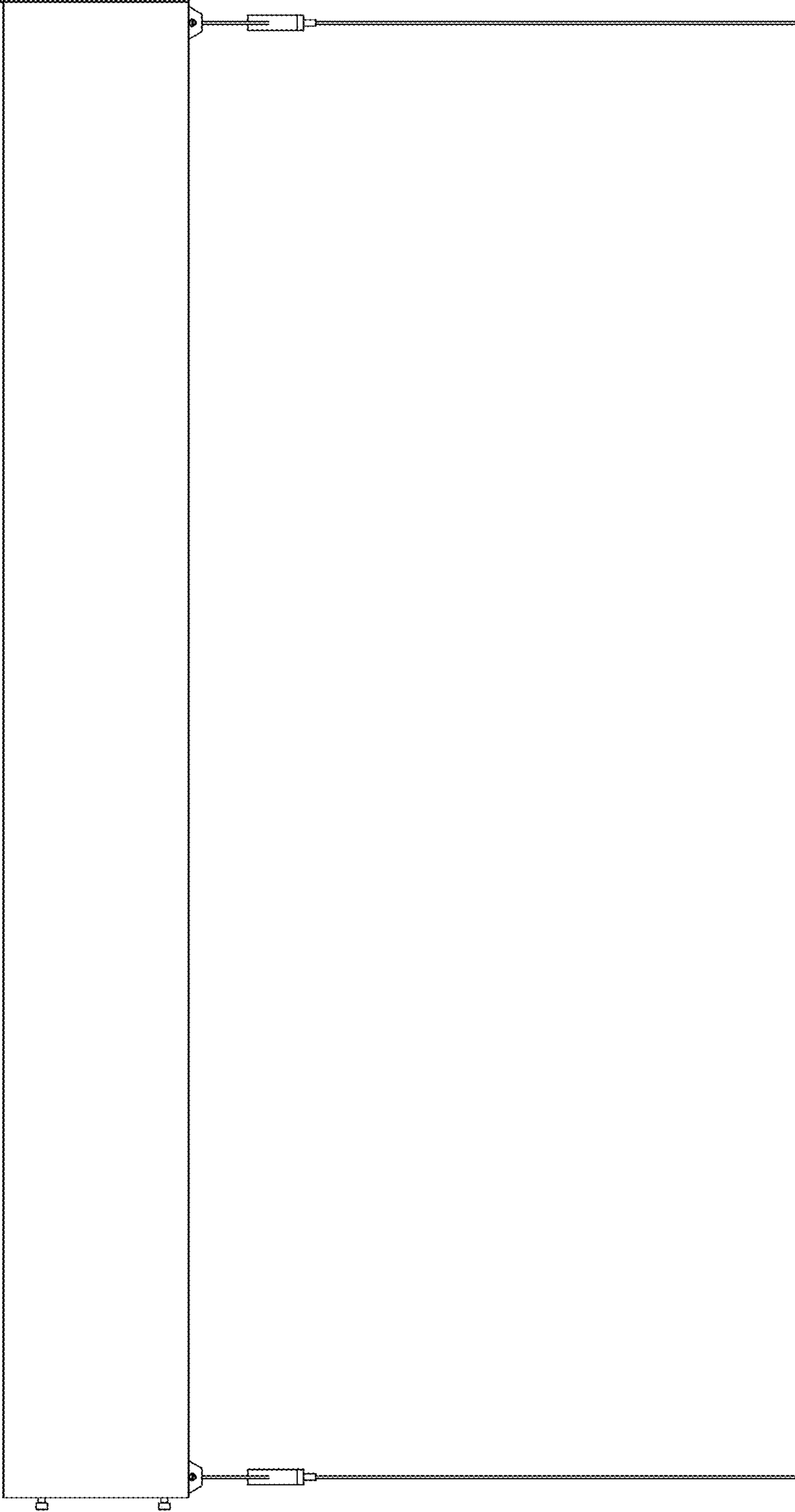

FIG. 47

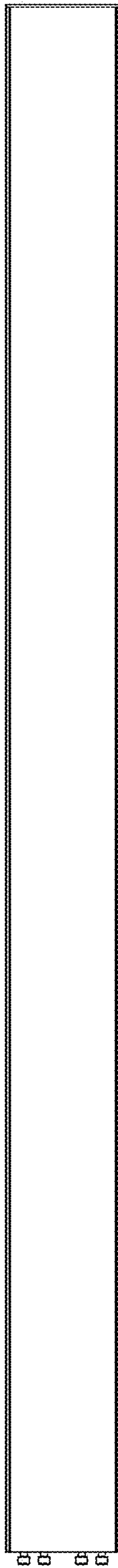

FIG. 48