



US00D700306S

(12) **United States Design Patent**
Seki

(10) **Patent No.:** **US D700,306 S**

(45) **Date of Patent:** **** Feb. 25, 2014**

(54) **AIR CONDITIONER**

(71) Applicant: **Daikin Industries Ltd.**, Osaka (JP)

(72) Inventor: **Kouichirou Seki**, Kusatsu (JP)

(73) Assignee: **Daikin Industries Ltd.**, Osaka-shi,
Osaka-fu (JP)

(**) Term: **14 Years**

(21) Appl. No.: **29/442,263**

(22) Filed: **Jan. 17, 2013**

(30) **Foreign Application Priority Data**

Jul. 26, 2012 (JP) 2012-017816

(51) **LOC (10) Cl.** **23-04**

(52) **U.S. Cl.**
USPC **D23/351**

(58) **Field of Classification Search**
USPC D23/351-354, 385, 355, 357, 361;
312/236; 62/259.1, 259.4, 262-263,
62/304; 454/330-331, 349-350
See application file for complete search history.

(56) **References Cited**

U.S. PATENT DOCUMENTS

D579,095 S * 10/2008 Nagahori et al. D23/351
D621,920 S * 8/2010 Yamana et al. D23/351

D642,250 S * 7/2011 Chouji D23/351
D657,035 S * 4/2012 Chouji D23/351
D688,780 S * 8/2013 Nakai et al. D23/351
D690,406 S * 9/2013 Seki D23/351
D690,801 S * 10/2013 Nakai et al. D23/351

* cited by examiner

Primary Examiner — Brian N Vinson

(74) *Attorney, Agent, or Firm* — Manabu Kanesaka

(57) **CLAIM**

The ornamental design for an air conditioner, as shown and described.

DESCRIPTION

FIG. 1 is a perspective view of an air conditioner showing my new design;
FIG. 2 is a front view thereof;
FIG. 3 is a rear view thereof;
FIG. 4 is a left side view thereof;
FIG. 5 is a right side view thereof;
FIG. 6 is a plan view thereof;
FIG. 7 is a bottom view thereof; and,
FIG. 8 is a cross-sectional view thereof along the line 8-8 in FIG. 2.

The broken lines depict portions of the air conditioner that form no part of claimed design.

1 Claim, 7 Drawing Sheets

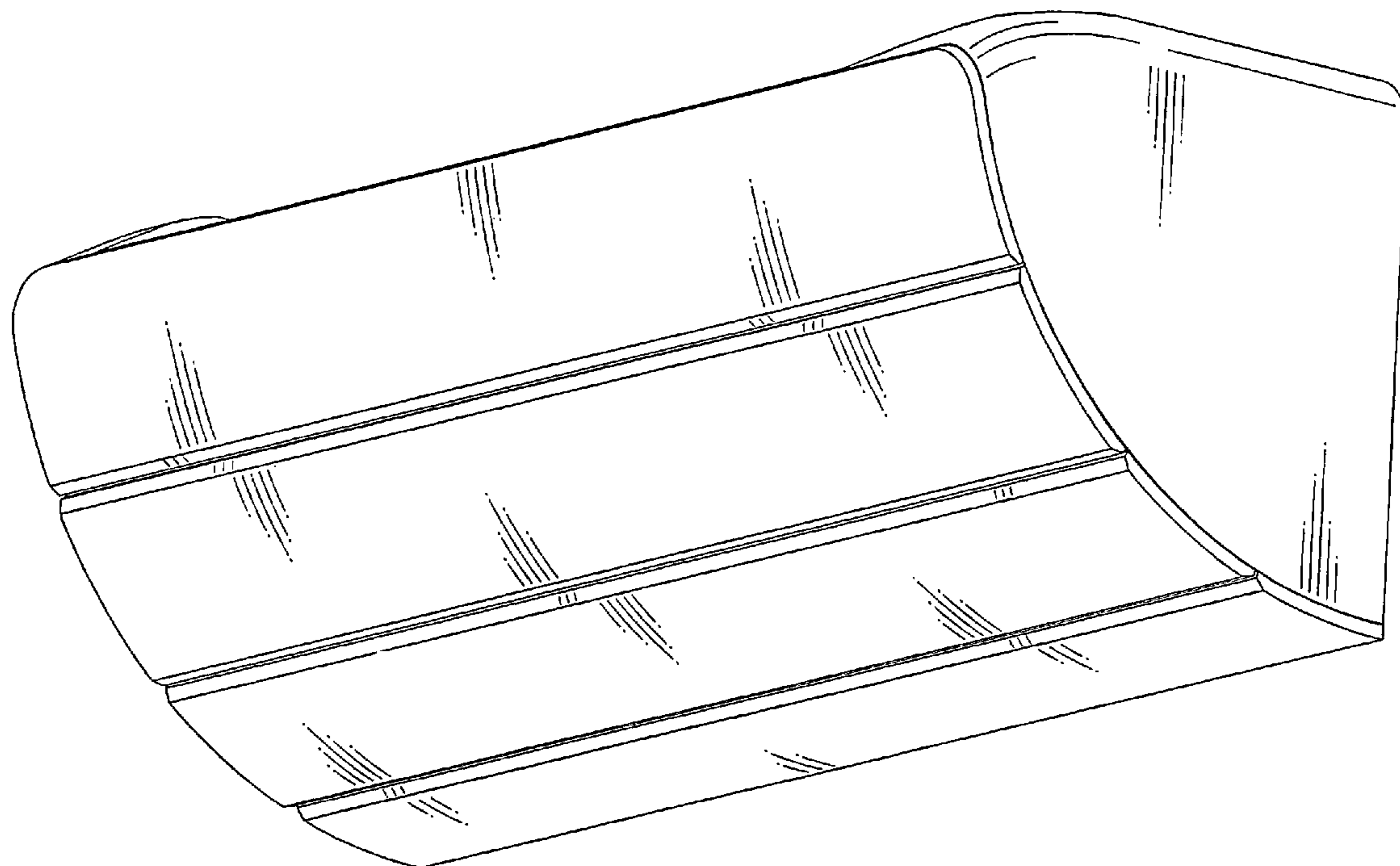

Fig. 1

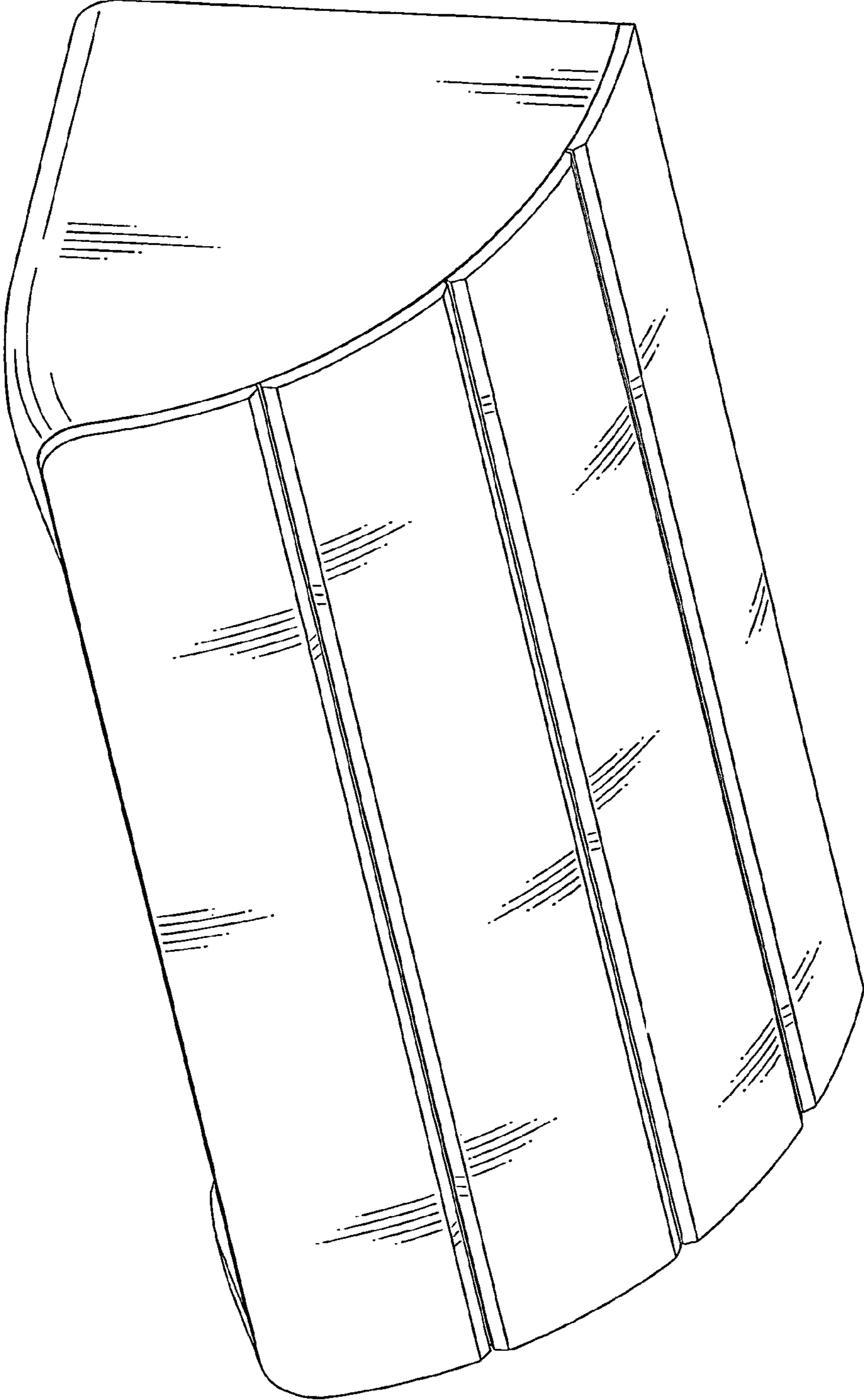

Fig. 2

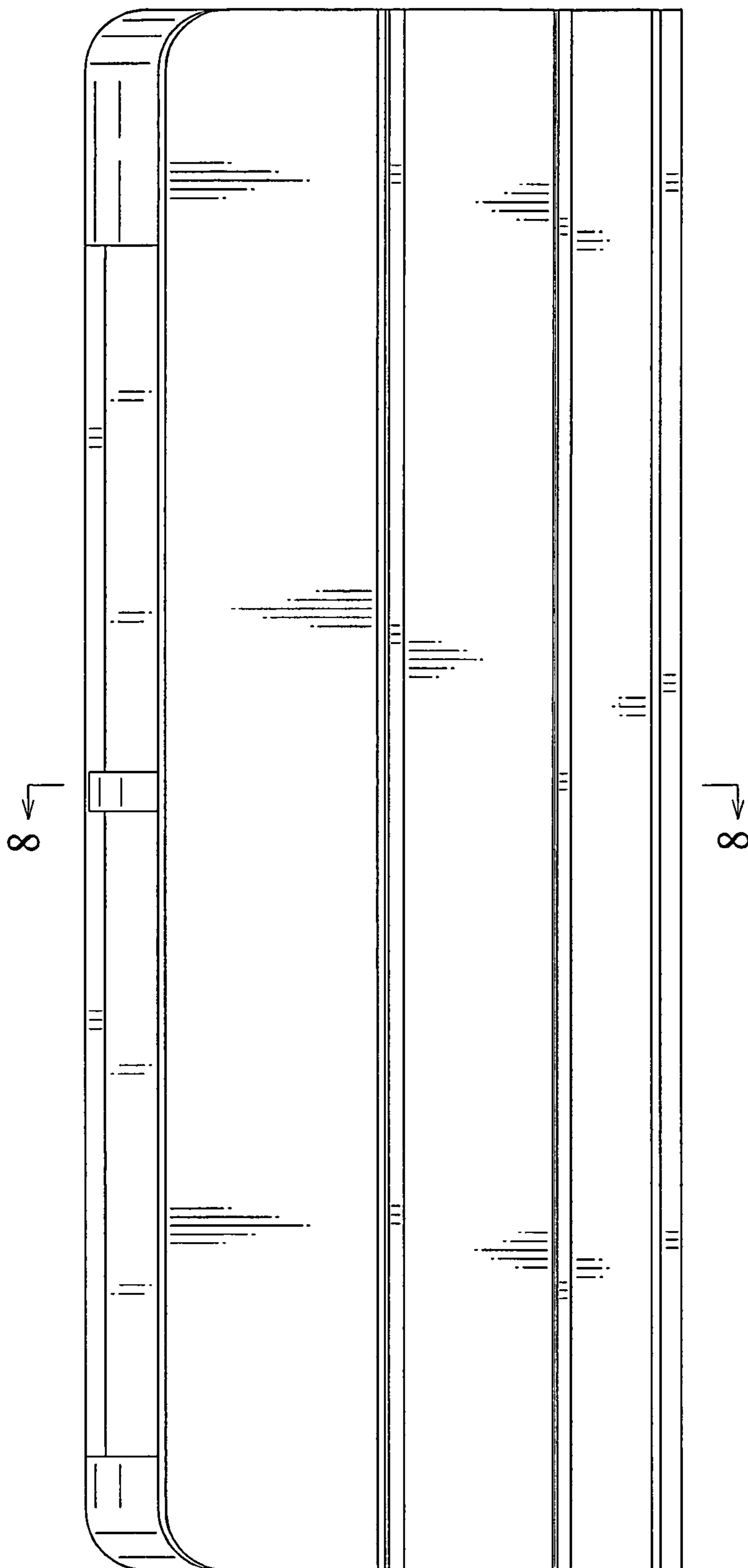

Fig. 3

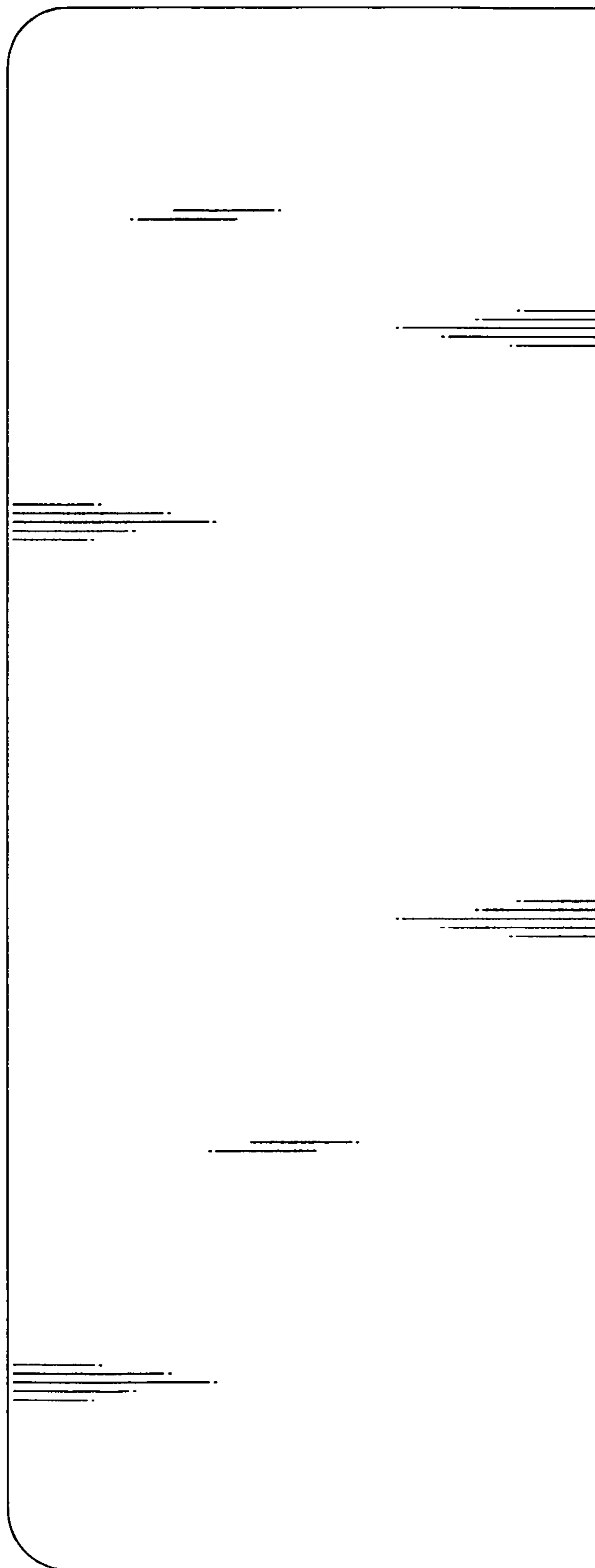

Fig. 5

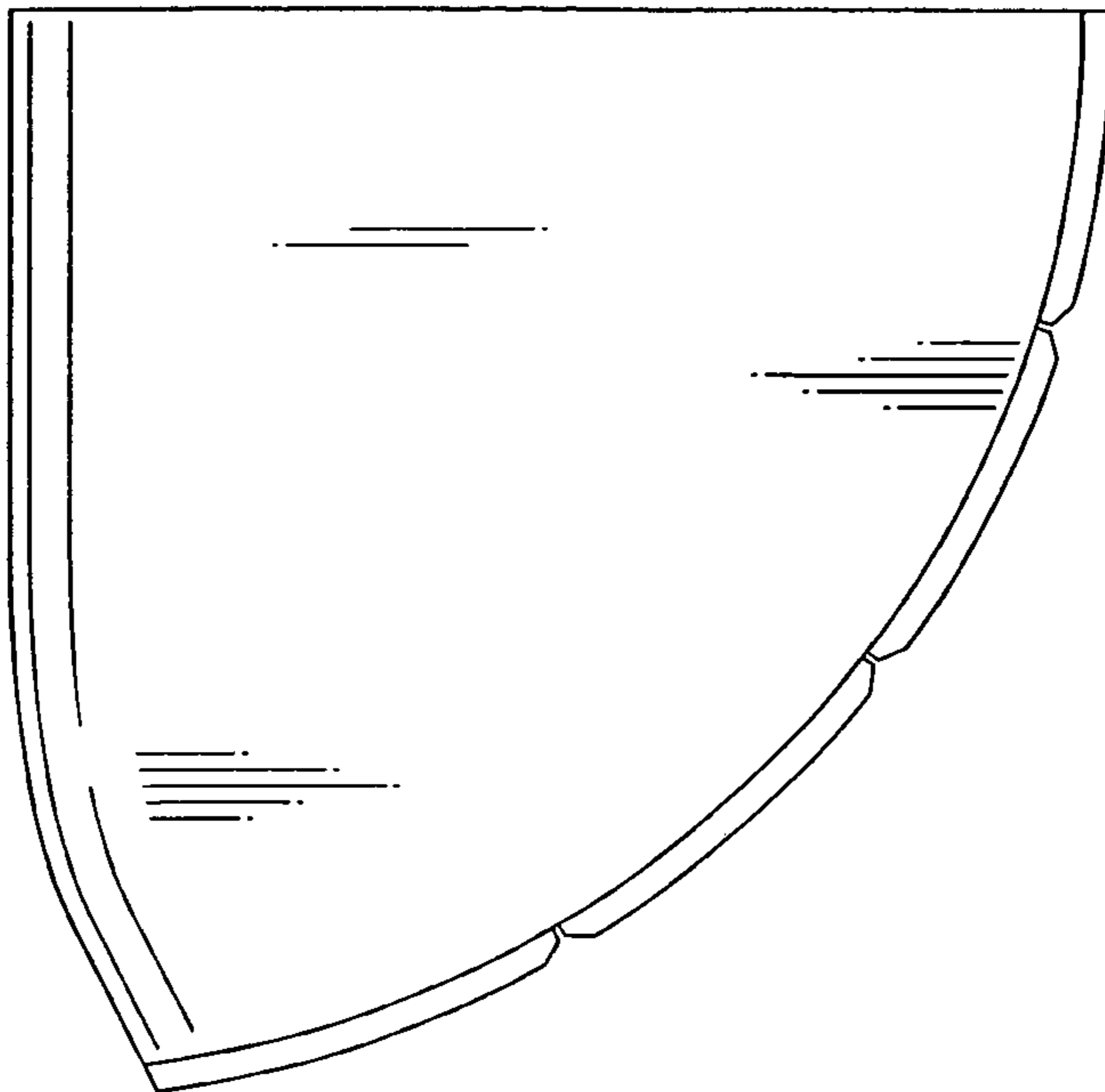

Fig. 4

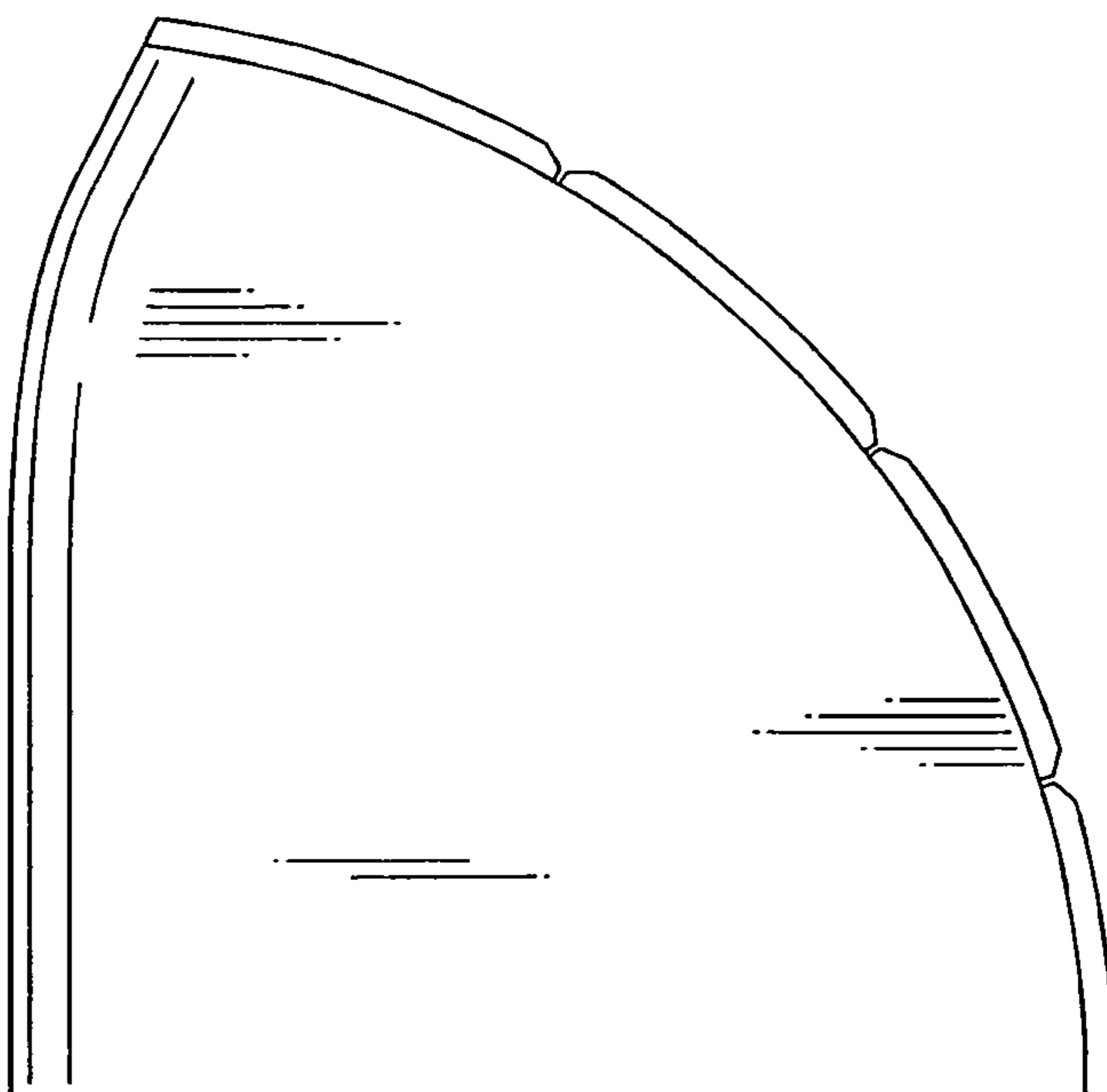

Fig. 6

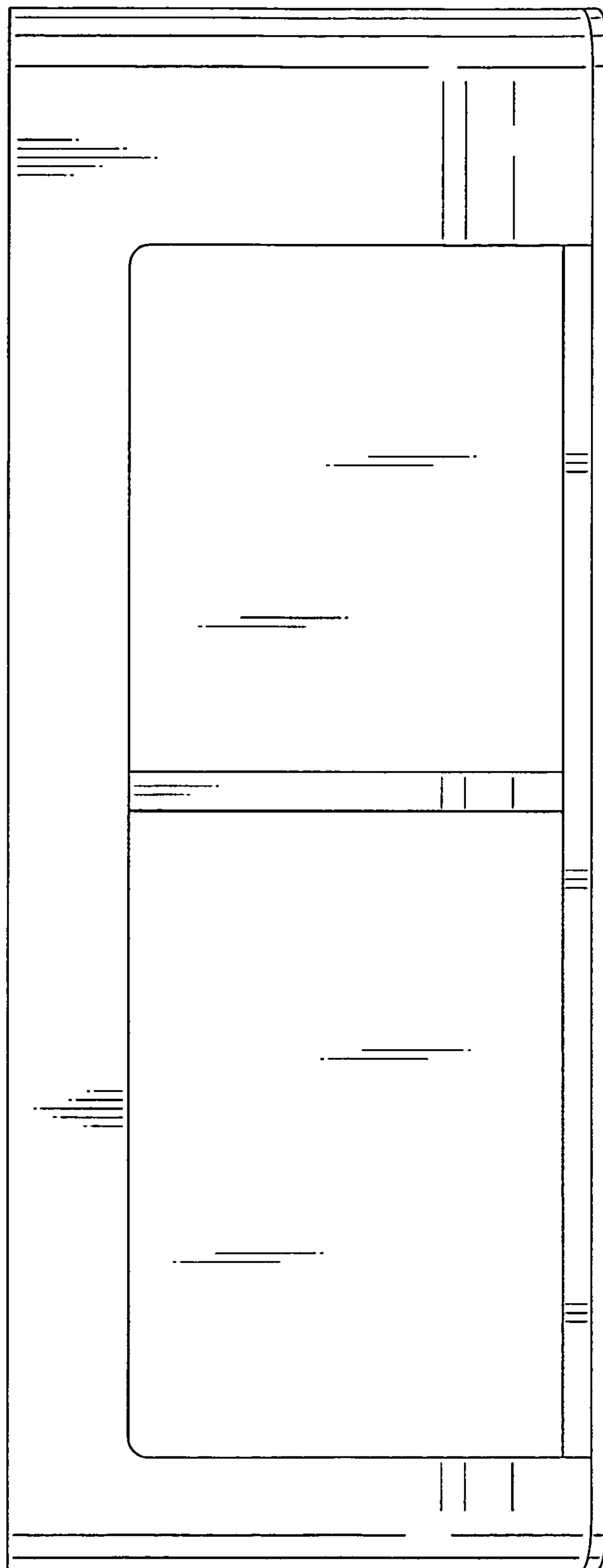

Fig. 7

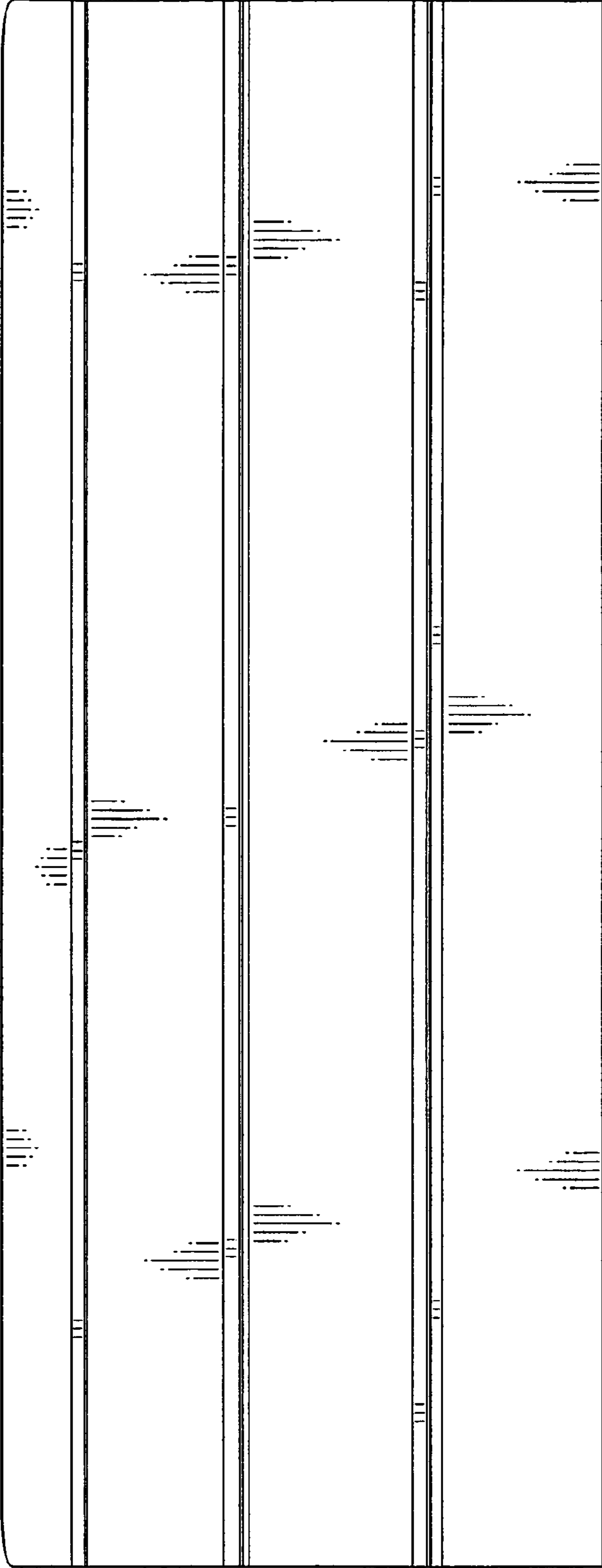

Fig. 8

