

US00D700143S

(12) **United States Design Patent**
Ichio et al.

(10) **Patent No.:** **US D700,143 S**
(45) **Date of Patent:** **** Feb. 25, 2014**

(54) **CHARGING CONNECTOR FOR AN
AUTOMOBILE**

(75) Inventors: **Toshifumi Ichio**, Yokkaichi (JP); **Yuuji Kida**, Yokkaichi (JP)

(73) Assignee: **Sumitomo Wiring Systems, Ltd.**,
Mie-ken (JP)

(**) Term: **14 Years**

(21) Appl. No.: **29/409,034**

(22) Filed: **Dec. 20, 2011**

(30) **Foreign Application Priority Data**

Jul. 5, 2011 (JP) 2011-015432
Oct. 20, 2011 (JP) 2011-024073

(51) **LOC (10) Cl.** **13-03**

(52) **U.S. Cl.**
USPC **D13/146; D13/120; D13/133**

(58) **Field of Classification Search**
USPC D13/107-110, 118-120, 133, 146, 147,
D13/154, 156, 184, 199; 439/34, 153, 246,
439/252, 259, 278, 282, 296, 304, 310, 353,
439/374, 378-381, 455, 456, 476.1, 483,
439/519, 527, 532, 533, 597-598, 600, 660,
439/680, 862, 894; 320/103, 104, 105, 107,
320/108, 109

See application file for complete search history.

(56) **References Cited**

U.S. PATENT DOCUMENTS

D634,709 S * 3/2011 Ichio D13/119
D636,334 S * 4/2011 Kato et al. D13/119

(Continued)

FOREIGN PATENT DOCUMENTS

JP 1383009 3/2010
JP 1398789 10/2010

(Continued)

OTHER PUBLICATIONS

Automakers Agree on Common Charging Systems for EVs. GreenPacks.org [online]. Oct. 17, 2011 [retrieved on Nov. 1, 2013]. Retrieved from the Internet: <<http://www.greenpacks.org/2011/10/17/automakers-agree-on-common-charging-systems-for-evs/>>.*

Primary Examiner — Jeffrey D Asch

Assistant Examiner — Ramzi Almatrahi

(74) *Attorney, Agent, or Firm* — Fish & Richardson P.C.

(57) **CLAIM**

The ornamental design for a charging connector for an automobile, as shown and described.

DESCRIPTION

FIG. 1 is a top-front-left perspective view of a first embodiment of a charging connector for an automobile showing our new design.

FIG. 2 is a top-front-right perspective view thereof.

FIG. 3 is a front elevational view thereof;

FIG. 4 is a rear elevational view thereof;

FIG. 5 is a top plan view thereof;

FIG. 6 is a bottom plan view thereof;

FIG. 7 is a right side elevational view thereof;

FIG. 8 is a left side elevational view thereof;

FIG. 9 is a top-front-left perspective view of a second embodiment of a charging connector for an automobile showing our new design.

FIG. 10 is a top-front-right perspective view thereof.

FIG. 11 is a front elevational view thereof;

FIG. 12 is a rear elevational view thereof;

FIG. 13 is a top plan view thereof;

FIG. 14 is a bottom plan view thereof;

FIG. 15 is a right side elevational view thereof; and,

FIG. 16 is a left side elevational view thereof.

The broken lines shown in FIGS. 6 and 8 that define unshaded regions represent the bounds of the first embodiment; the broken lines form no part of the first embodiment.

1 Claim, 12 Drawing Sheets

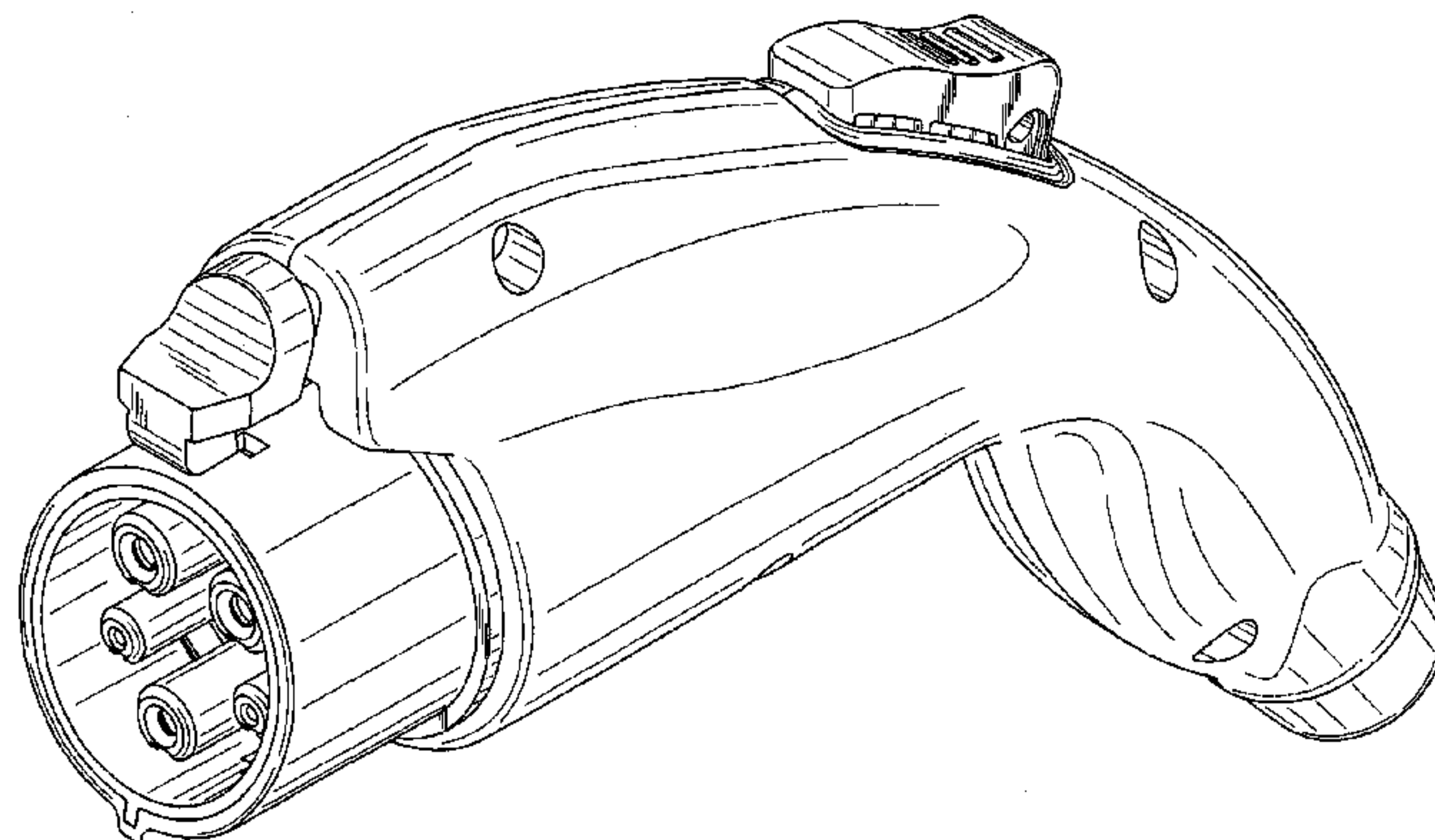

US D700,143 S

Page 2

(56)

References Cited

D677,632 S * 3/2013 Riddle et al. D13/146
D690,652 S * 10/2013 Anderson et al. D13/146

U.S. PATENT DOCUMENTS

8,152,550 B2 * 4/2012 Ichio et al. 439/304
D667,376 S * 9/2012 Mori et al. D13/133
D669,033 S * 10/2012 Senk et al. D13/146
D670,651 S * 11/2012 Mori et al. D13/133
D671,073 S * 11/2012 Mori et al. D13/133
8,342,856 B2 * 1/2013 Takada et al. 439/34

FOREIGN PATENT DOCUMENTS

JP 1398790 10/2010
JP 1416347 6/2011

* cited by examiner

FIG. 1

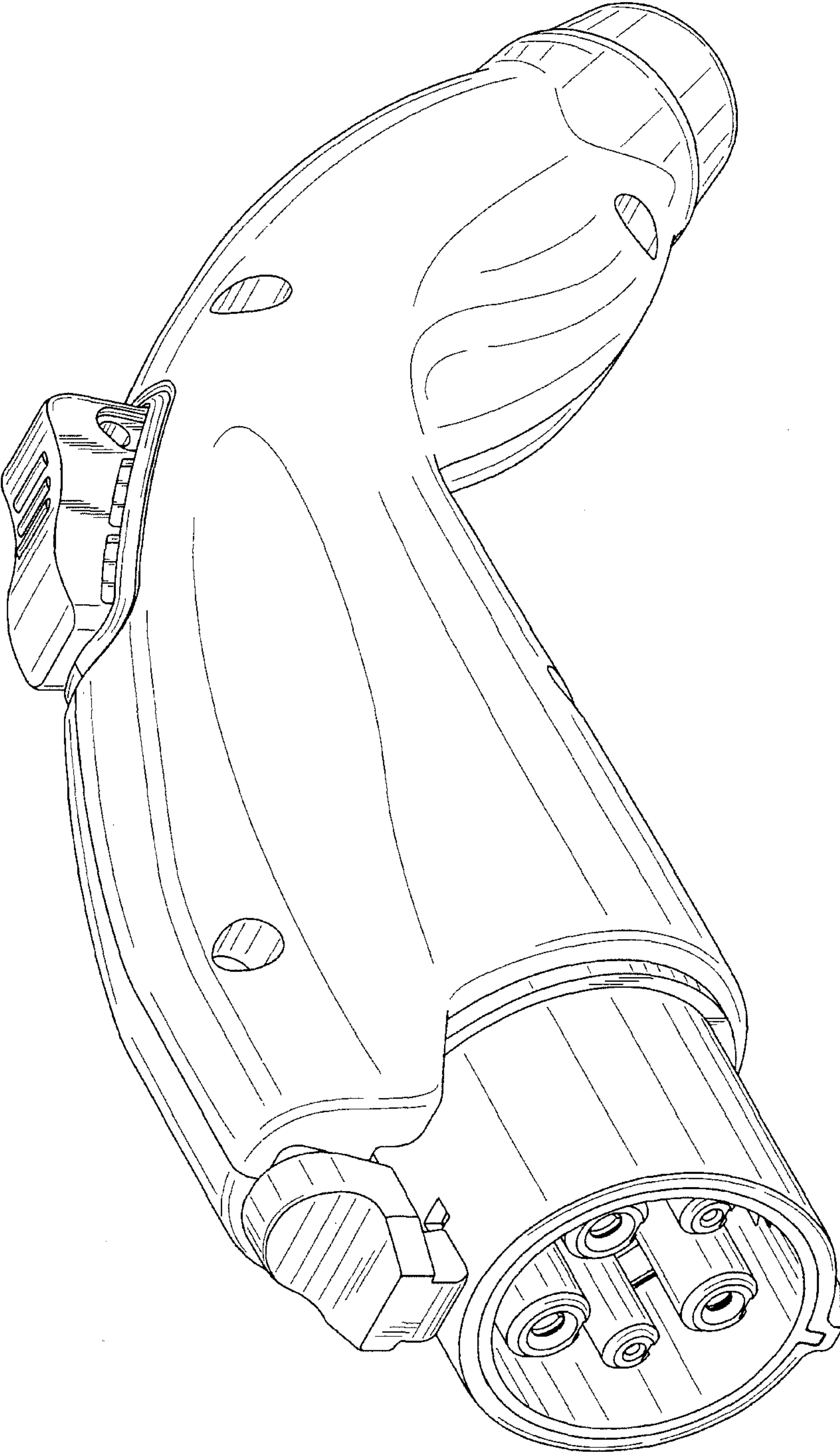

FIG. 2

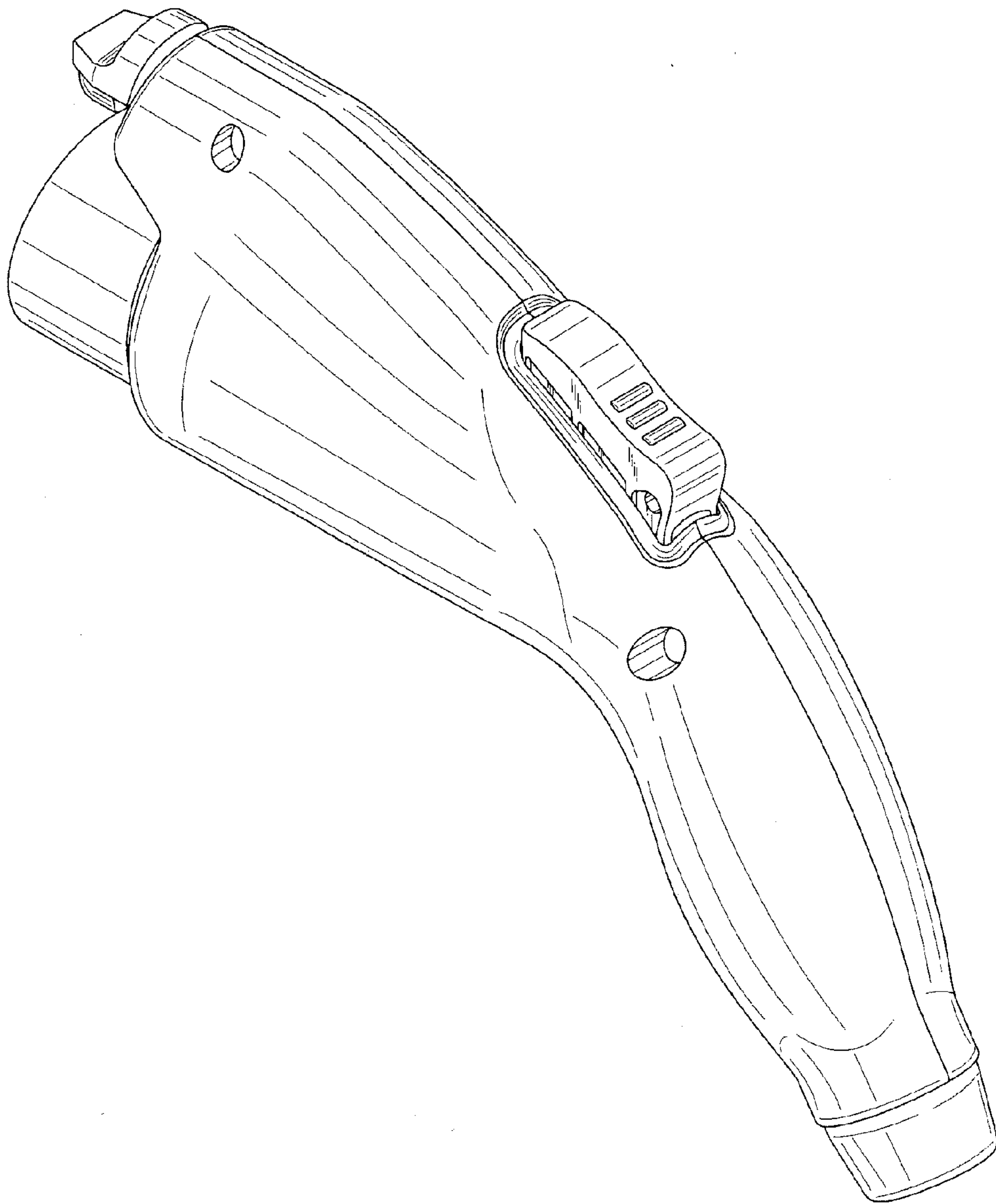

FIG. 3

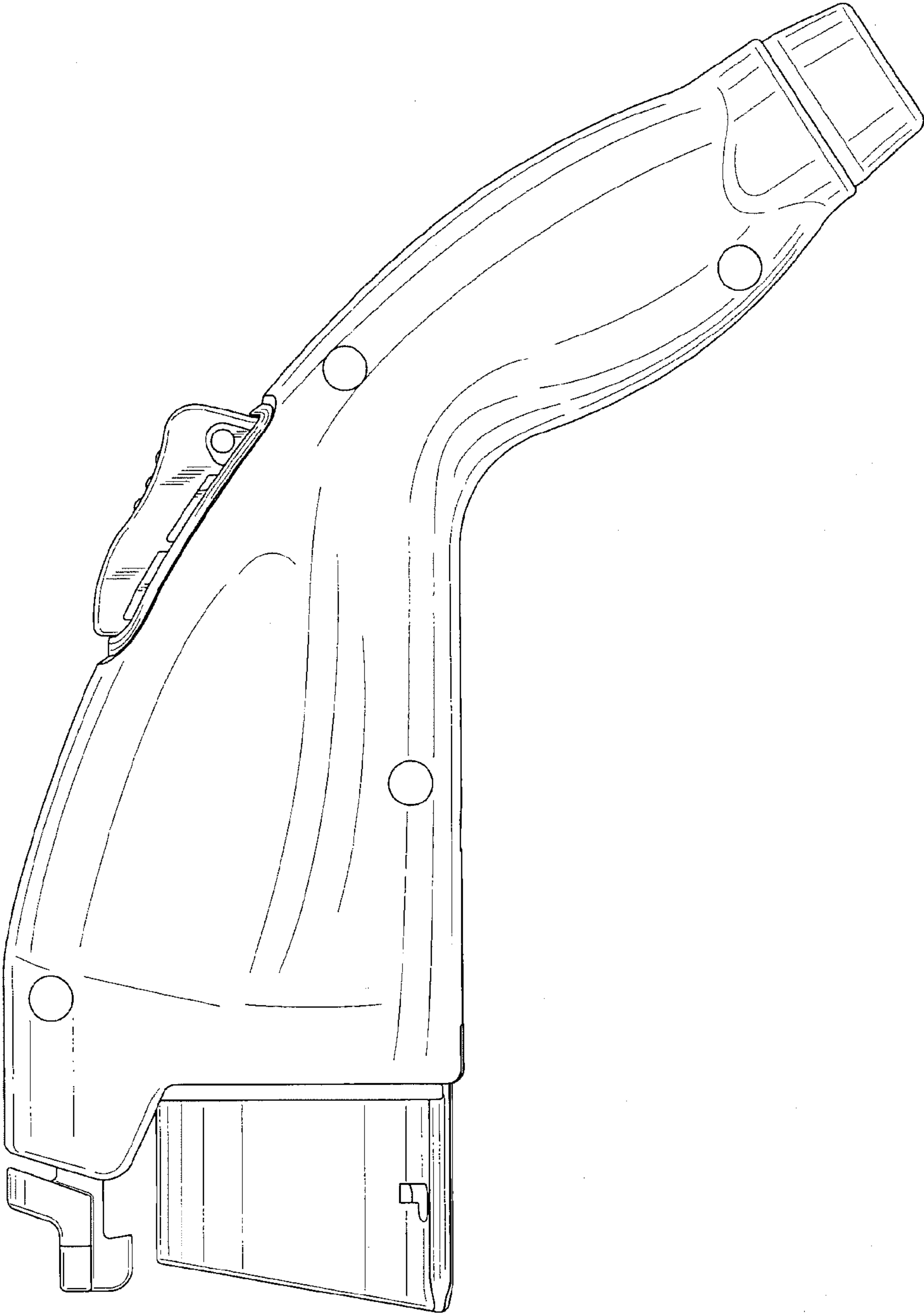

FIG. 4

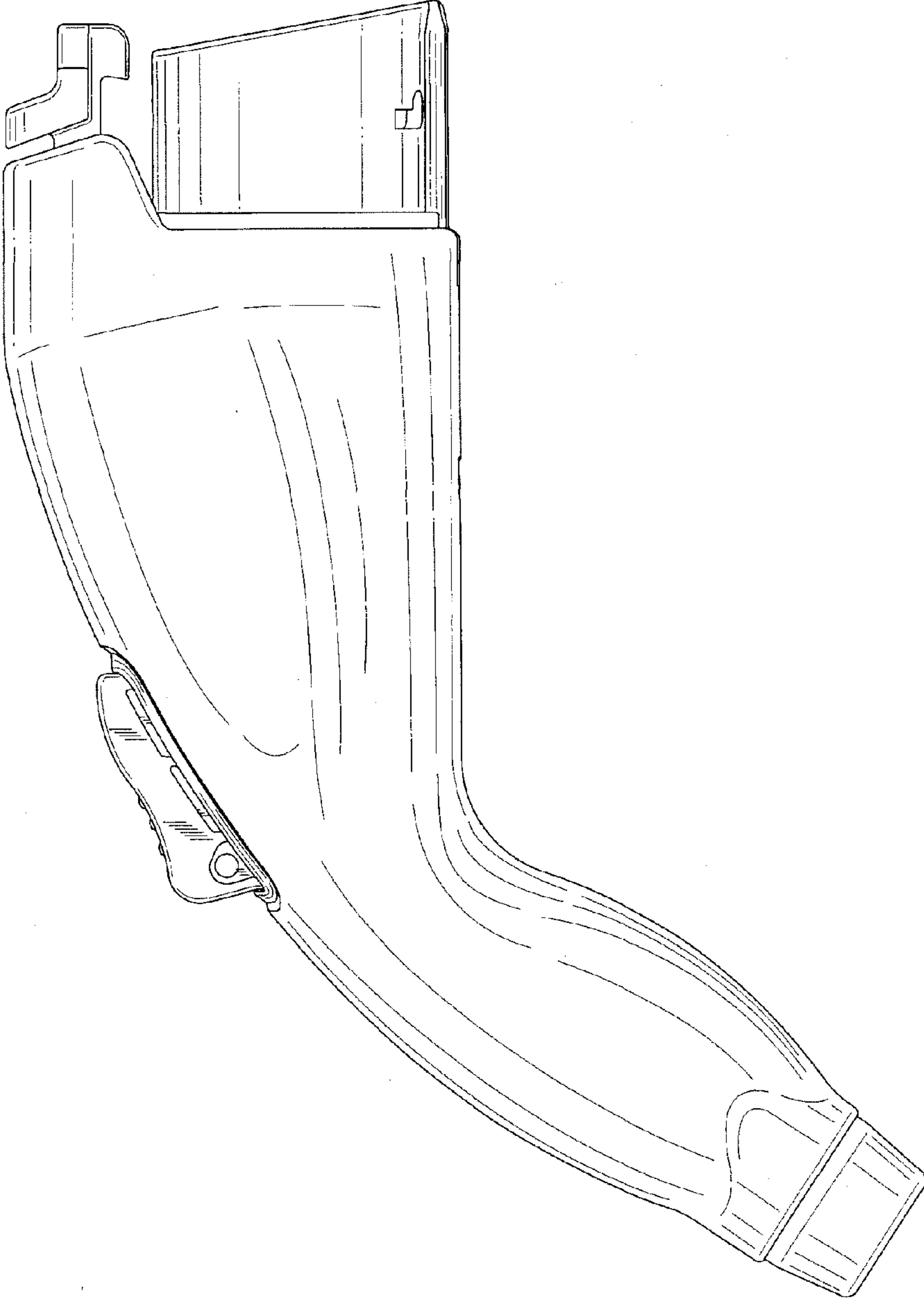

FIG. 5

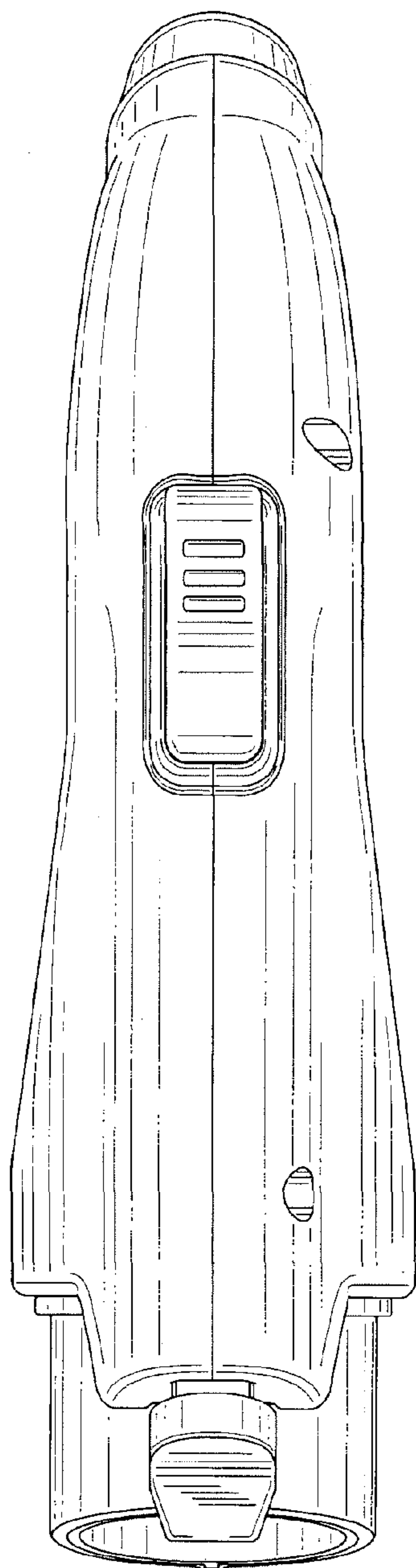

FIG. 6

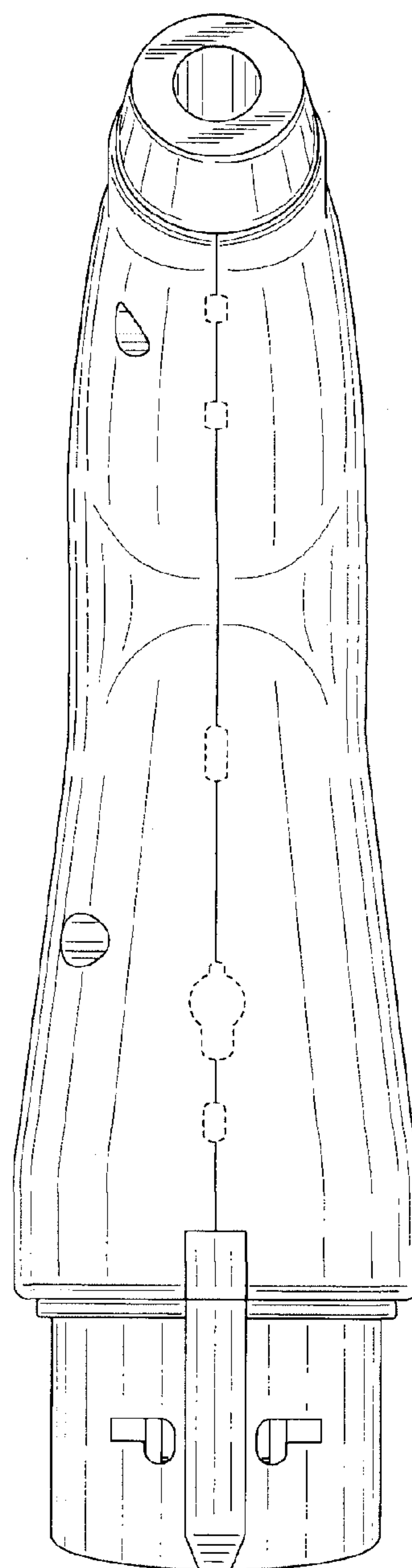

FIG. 7

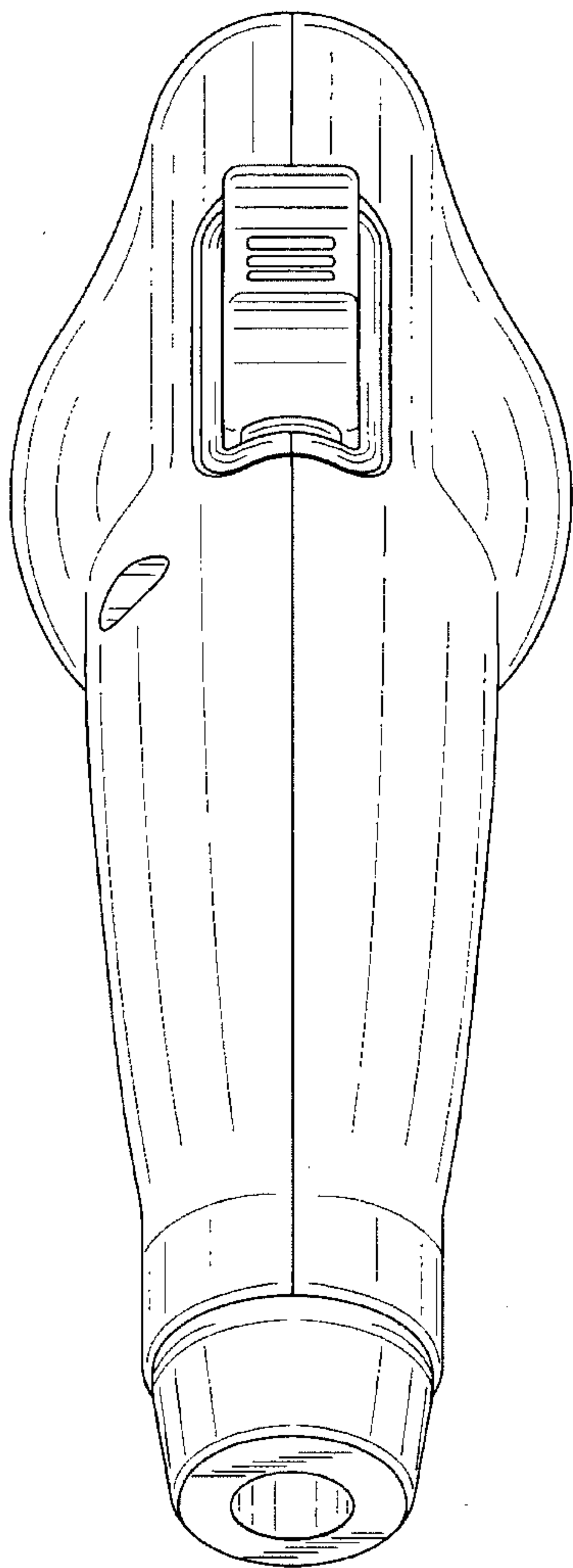

FIG. 8

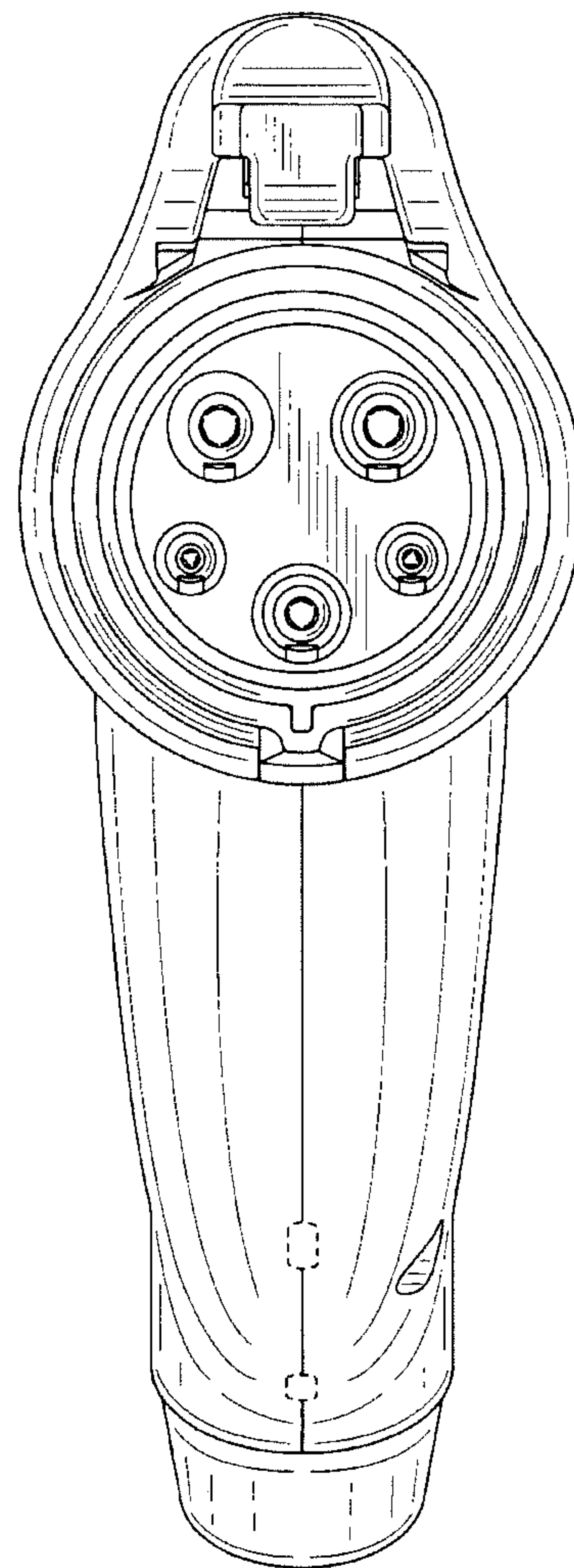

FIG. 9

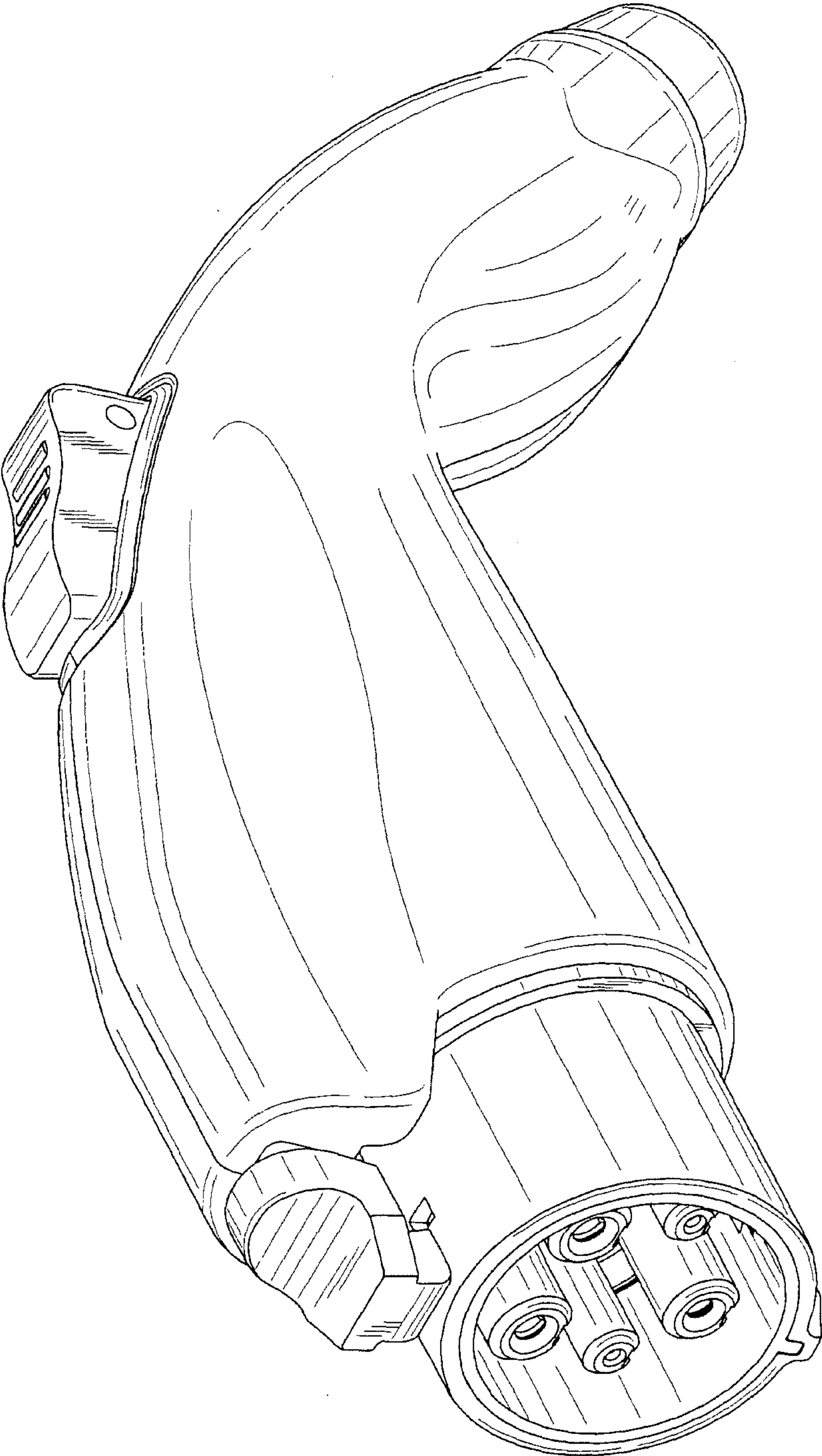

FIG. 10

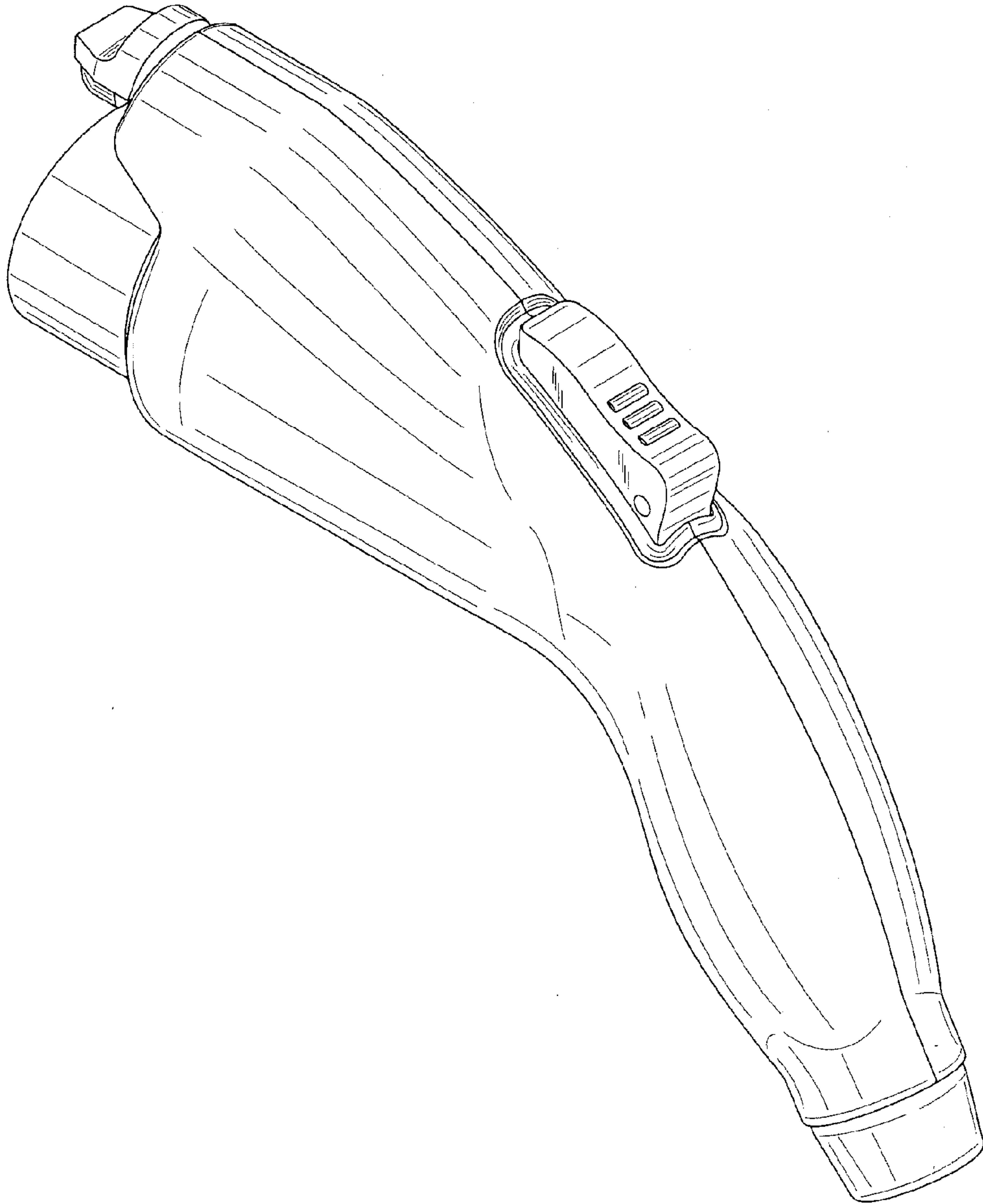

FIG. 11

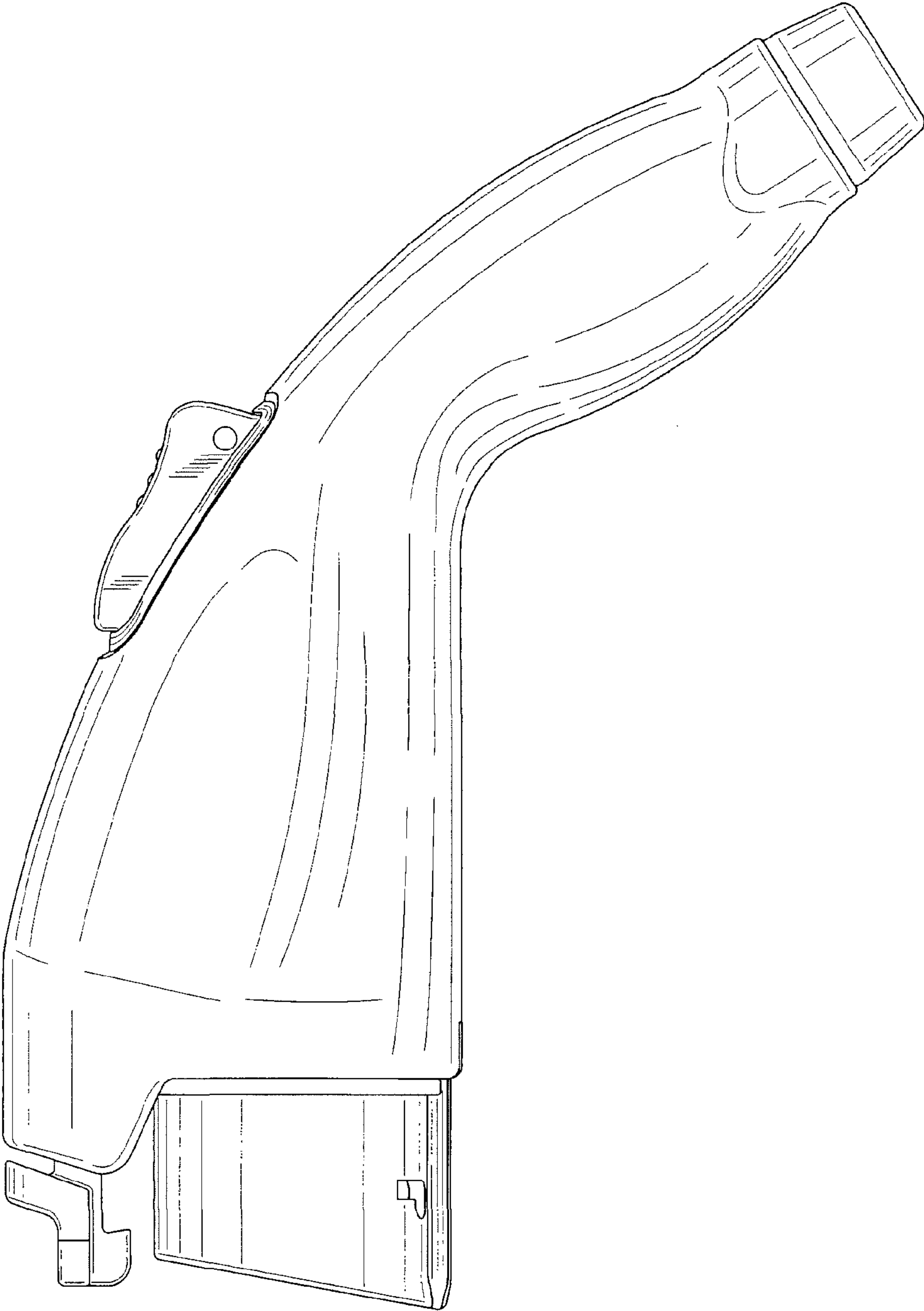

FIG. 12

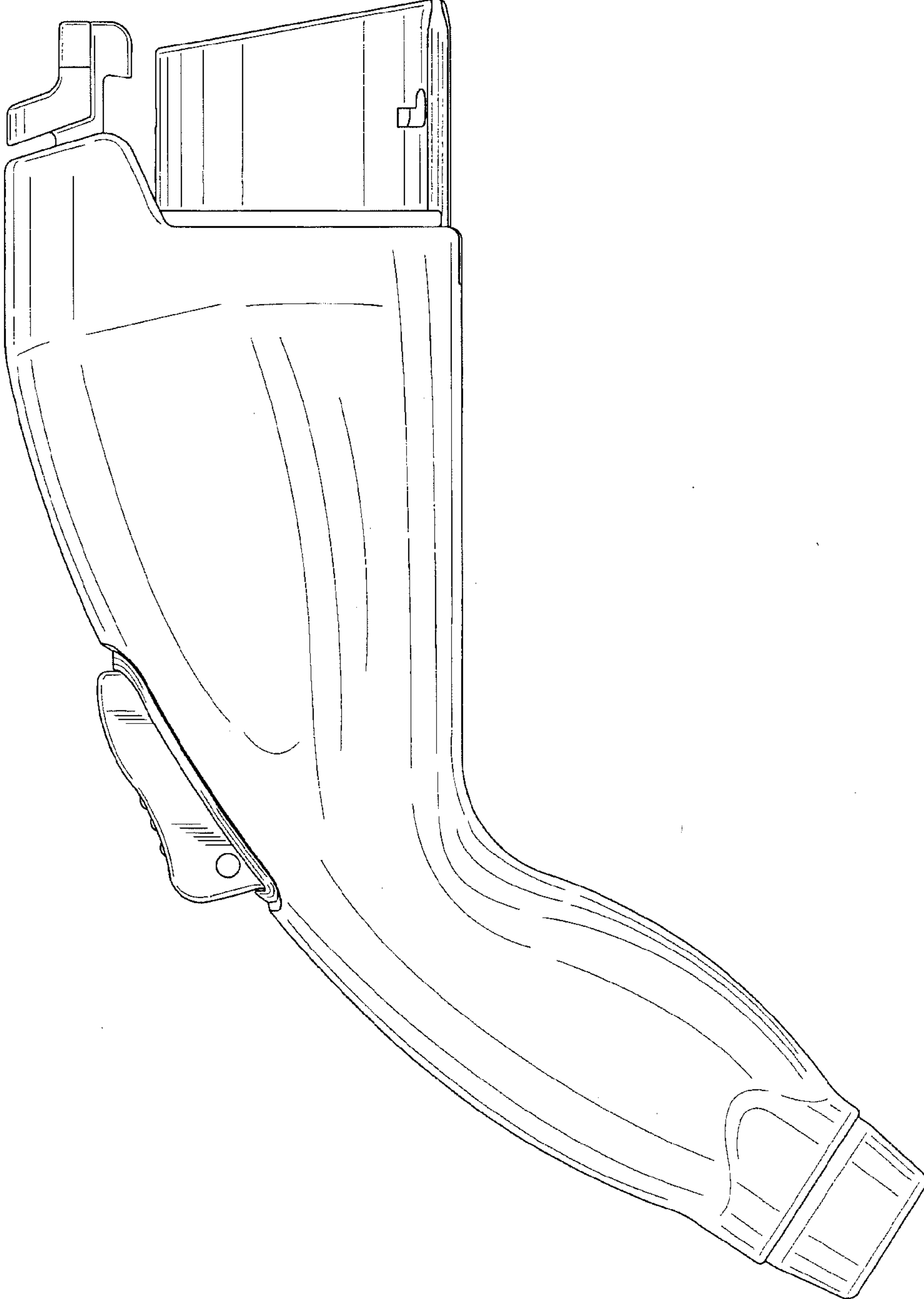

FIG. 13

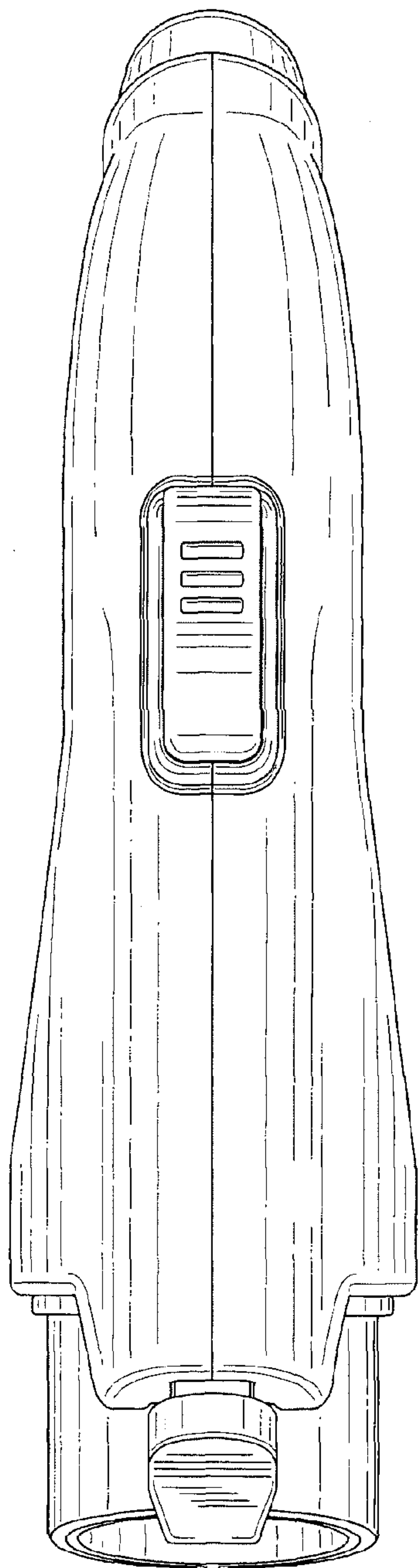

FIG. 14

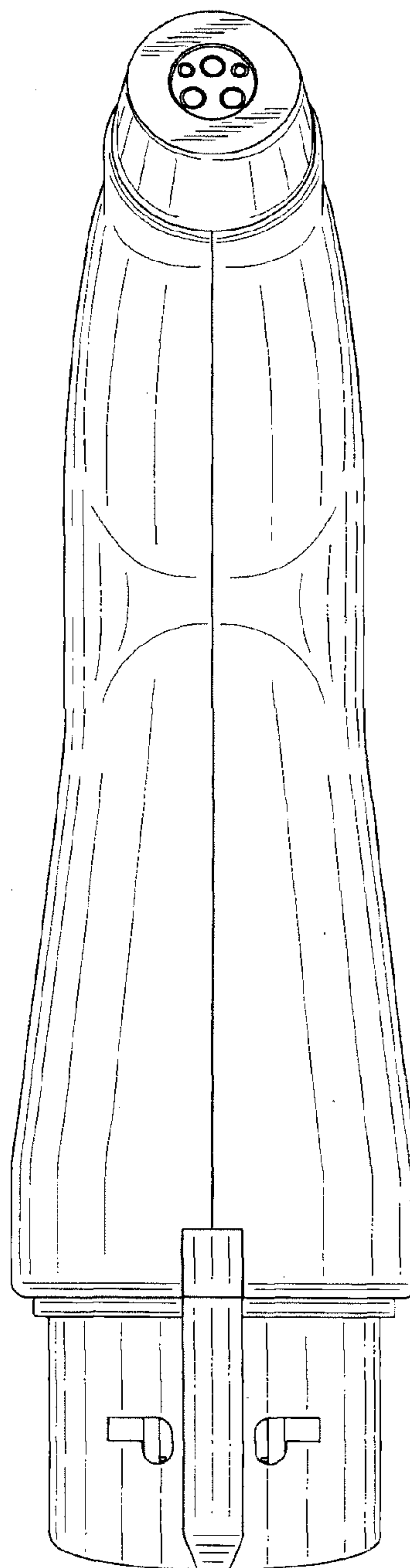

FIG. 15

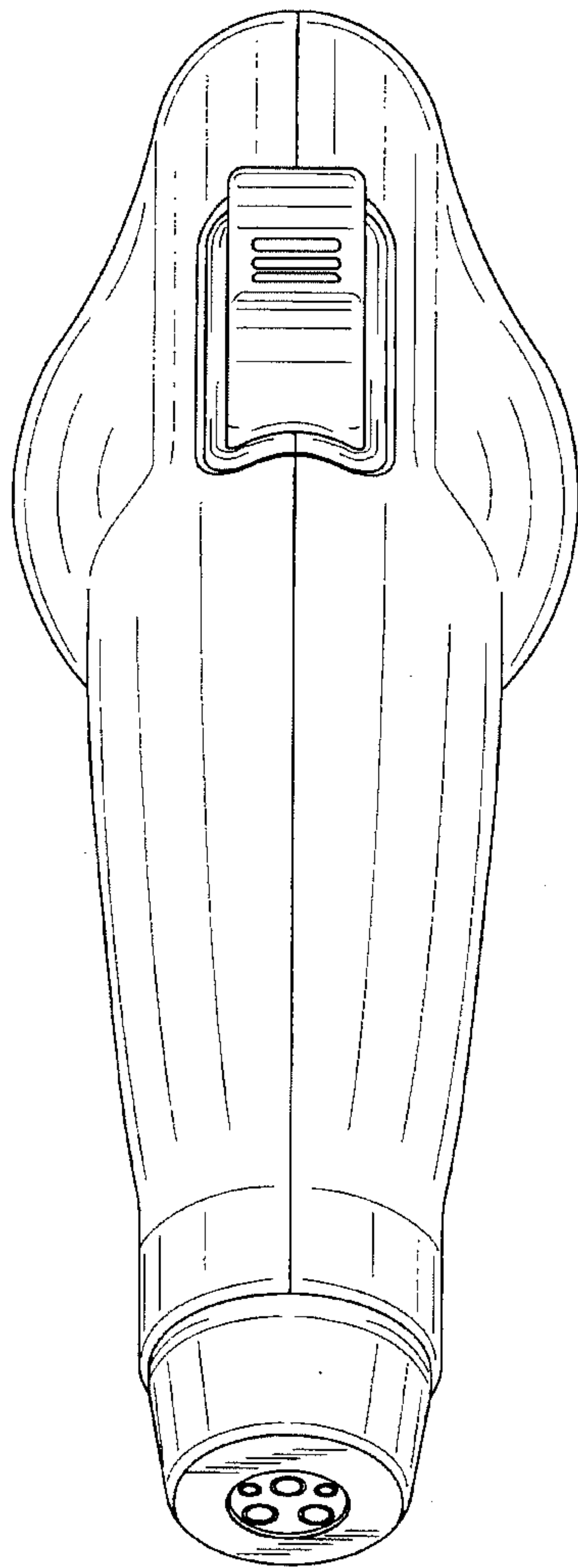

FIG. 16

