



US00D700139S

(12) **United States Design Patent**
Chan et al.

(10) **Patent No.:** **US D700,139 S**

(45) **Date of Patent:** **** Feb. 25, 2014**

(54) **EXTENDED BATTERY**

(71) Applicant: **ZeroLemon LLC**, Cheyenne, WY (US)

(72) Inventors: **Stephen Ching Yat Chan**, Hong Kong (HK); **Wei Chen**, Shenzhen (CN)

(73) Assignee: **ZeroLemon LLC**, Cheyenne, WY (US)

(**) Term: **14 Years**

(21) Appl. No.: **29/458,905**

(22) Filed: **Jun. 24, 2013**

(51) **LOC (10) Cl.** **13-02**

(52) **U.S. Cl.**
USPC **D13/103**

(58) **Field of Classification Search**
USPC D13/102-104, 110, 118-121, 184, 199;
429/96-100, 163, 176
See application file for complete search history.

(56) **References Cited**

U.S. PATENT DOCUMENTS

D320,212 S * 9/1991 Someya D14/242
D357,896 S * 5/1995 Berry D13/103
D375,933 S * 11/1996 Kao D13/103

D382,536 S * 8/1997 Amero, Jr. D13/103
D496,906 S * 10/2004 Vinciarelli et al. D13/110
D506,438 S * 6/2005 Vinciarelli et al. D13/110
D509,472 S * 9/2005 Vinciarelli et al. D13/110
D524,242 S * 7/2006 Adams et al. D13/103
D621,393 S * 8/2010 Panahi et al. D14/250
D629,365 S * 12/2010 Garcia De Vicuna D13/152
D649,933 S * 12/2011 Wang et al. D13/110
D662,044 S * 6/2012 Lemelman et al. D13/103
D689,019 S * 9/2013 Sato et al. D13/103

* cited by examiner

Primary Examiner — Rosemary K Tarcza

(74) *Attorney, Agent, or Firm* — Rabin & Berdo, P.C.

(57) **CLAIM**

The ornamental design for an extended battery, as shown and described.

DESCRIPTION

FIG. 1 is a perspective view of an extended battery;
FIG. 2 is another perspective view thereof;
FIG. 3 is a top view thereof;
FIG. 4 is a front view thereof;
FIG. 5 is a rear view thereof;
FIG. 6 is a left side view thereof;
FIG. 7 is a right side view thereof; and,
FIG. 8 is a bottom view thereof.

1 Claim, 3 Drawing Sheets

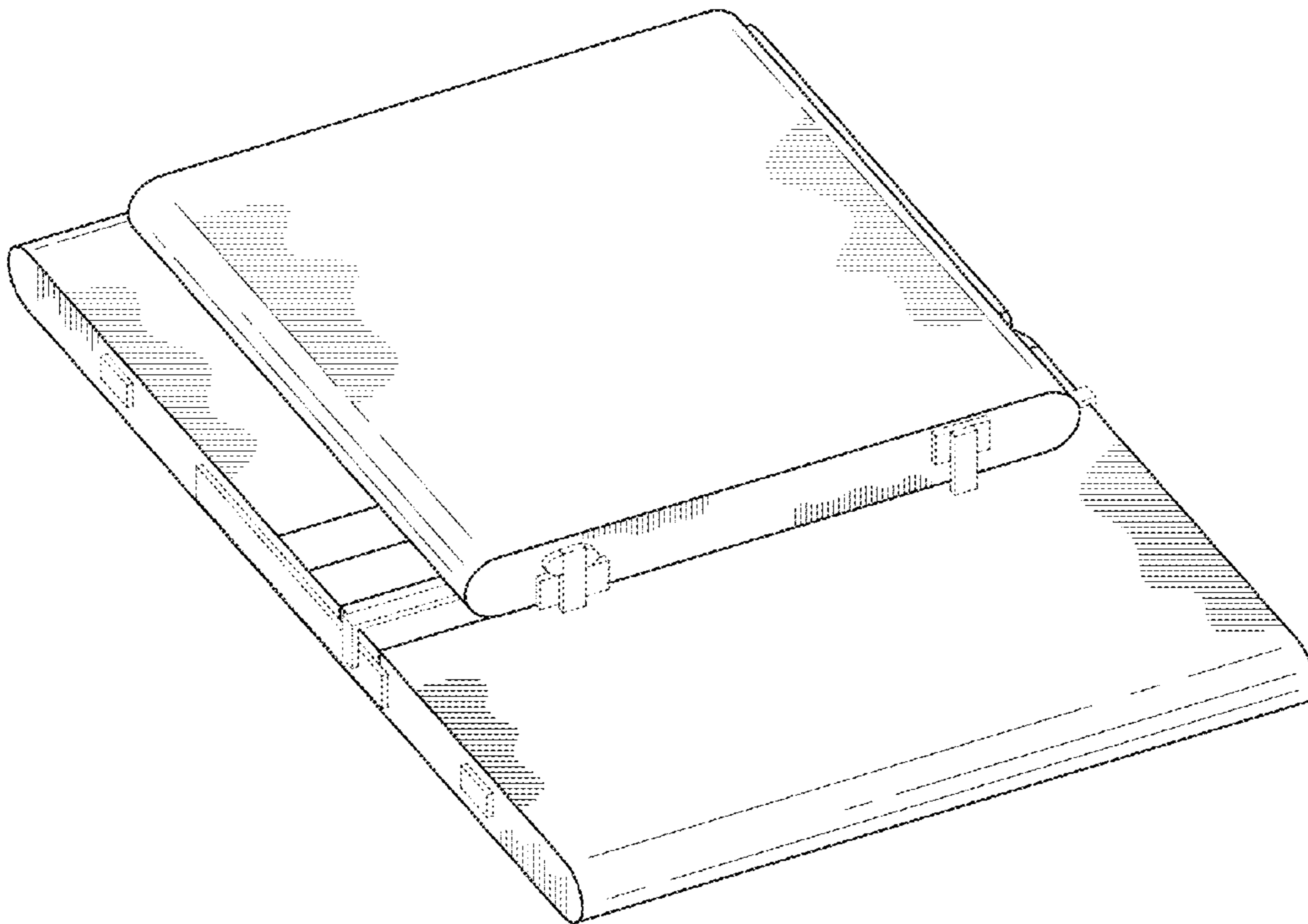

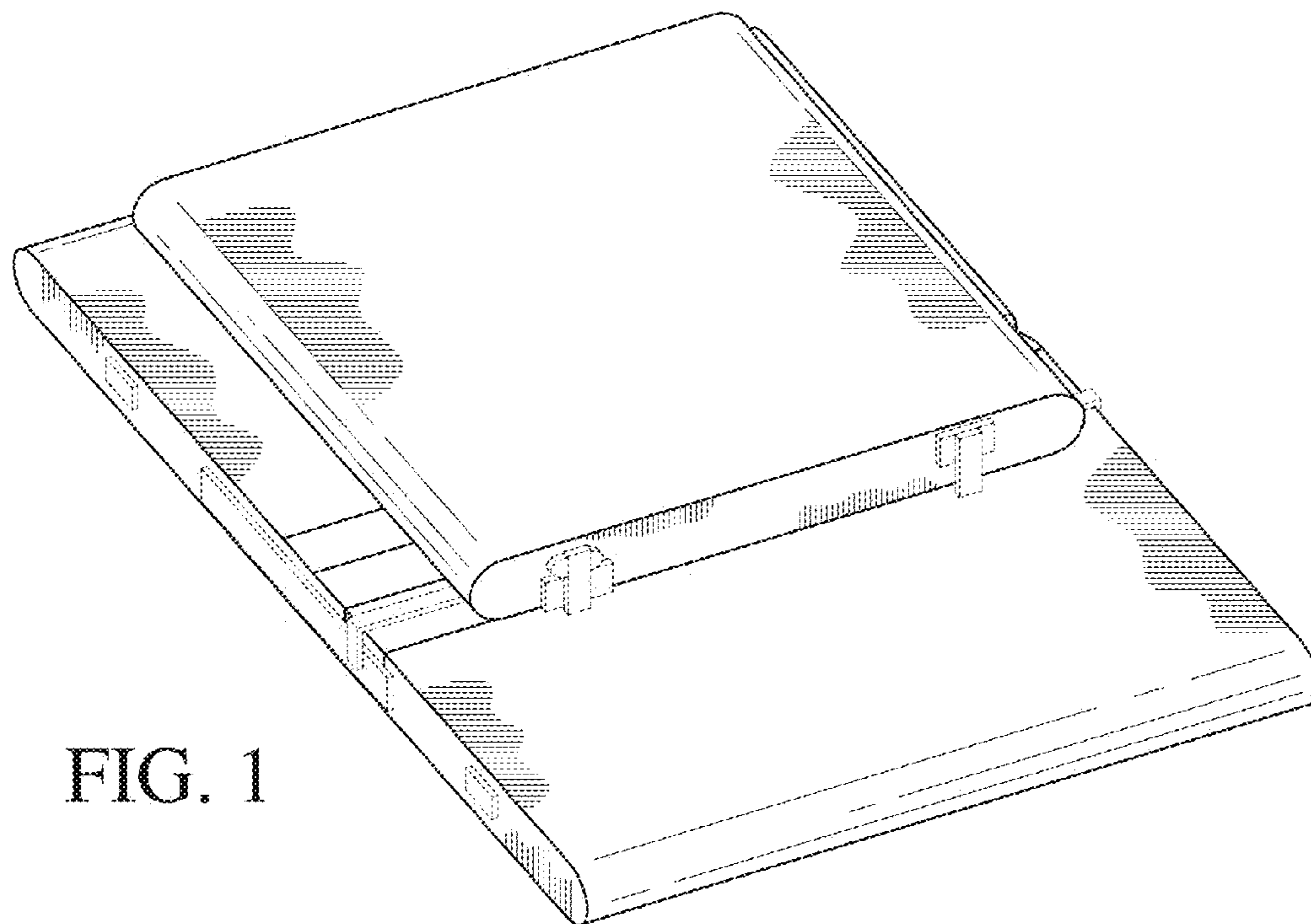

FIG. 1

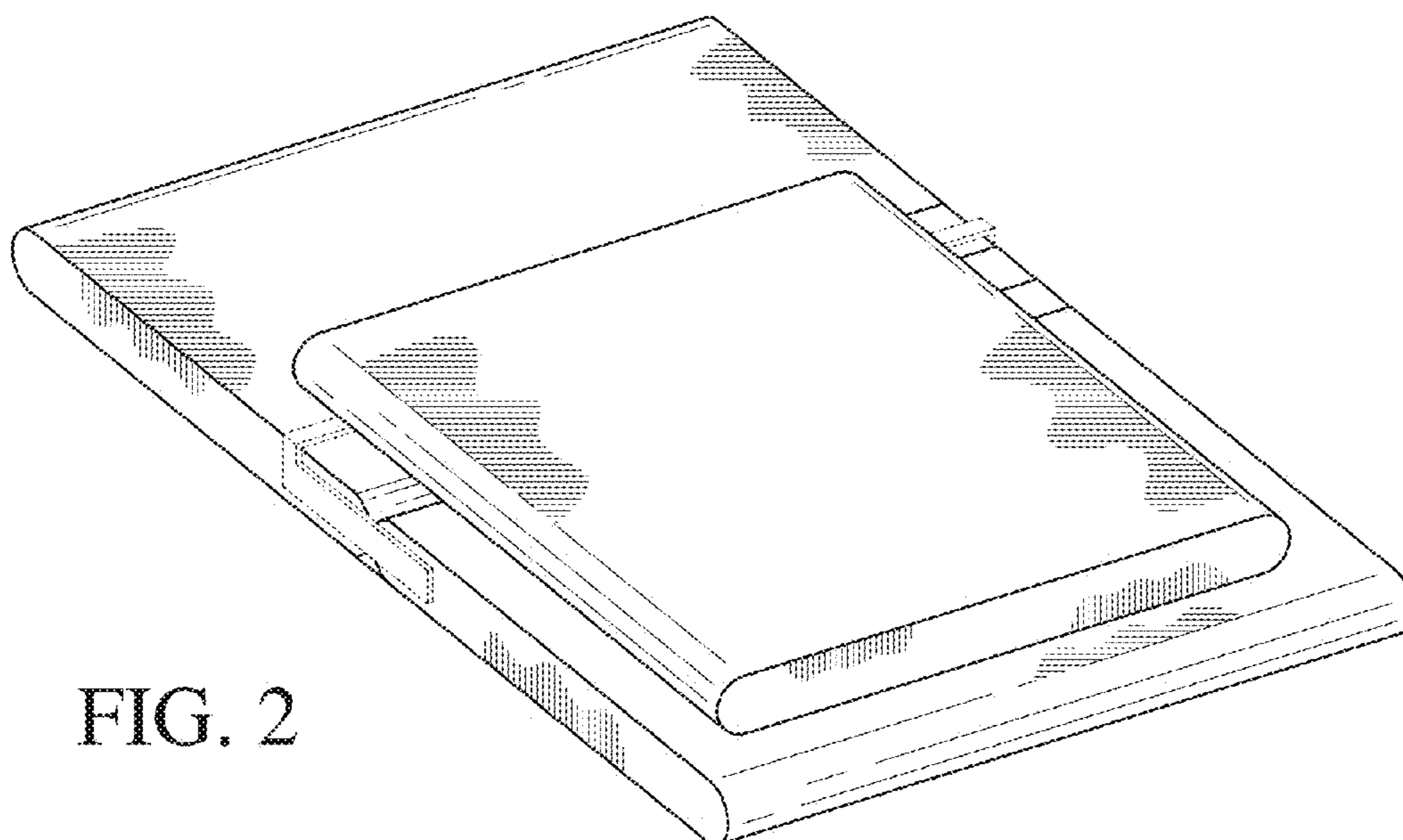

FIG. 2

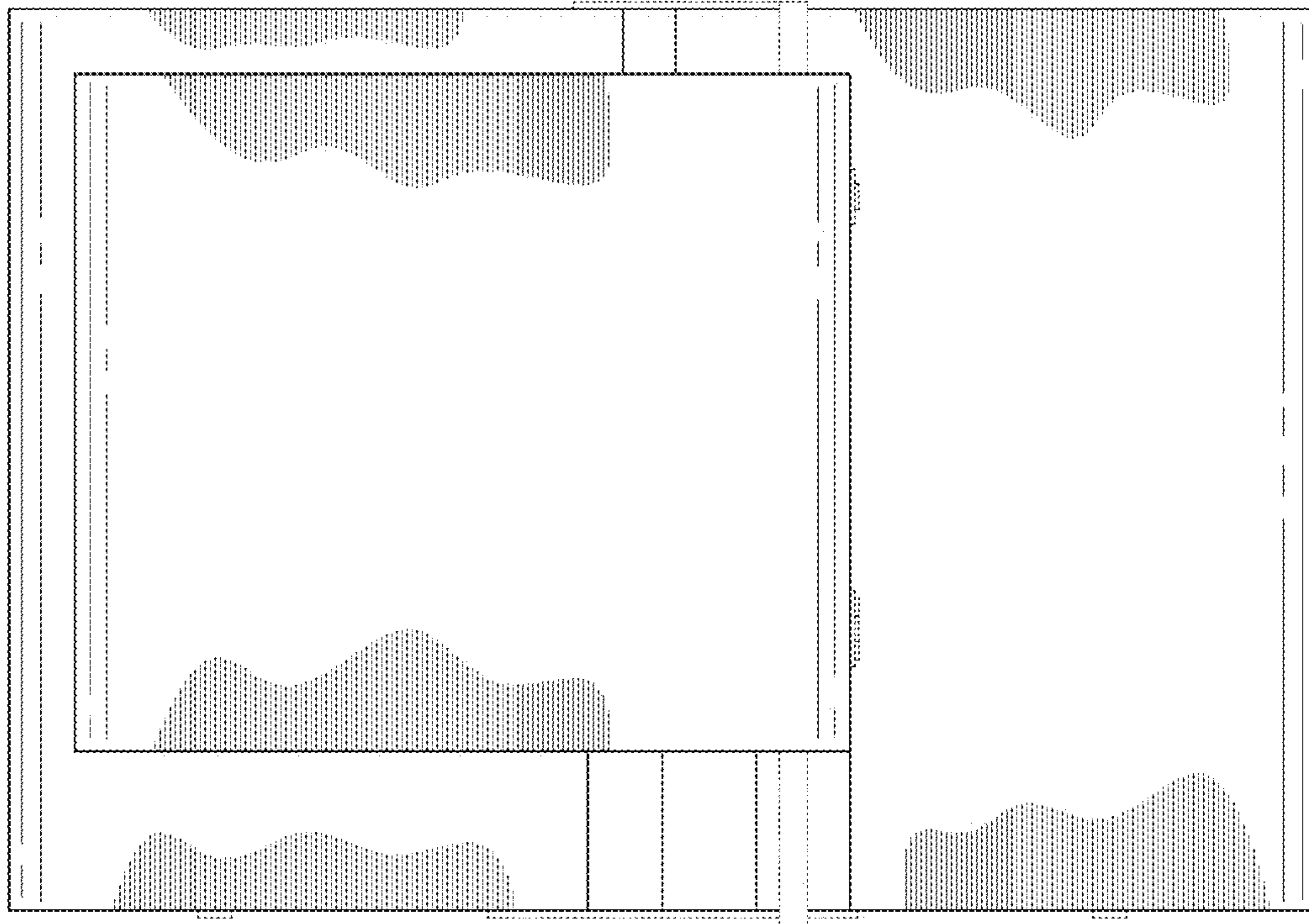

FIG. 3

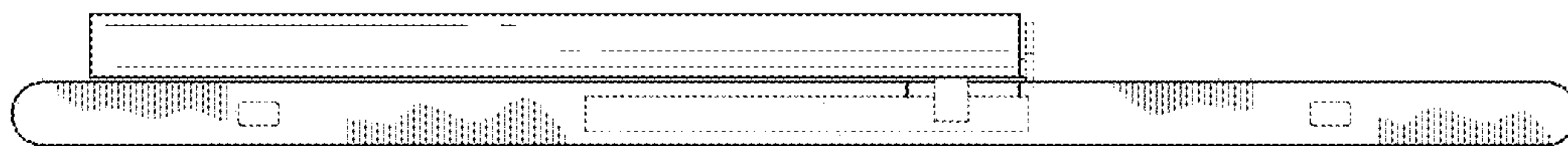

FIG. 4

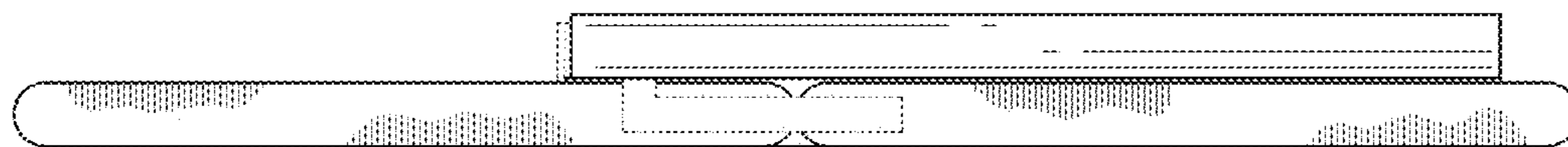

FIG. 5

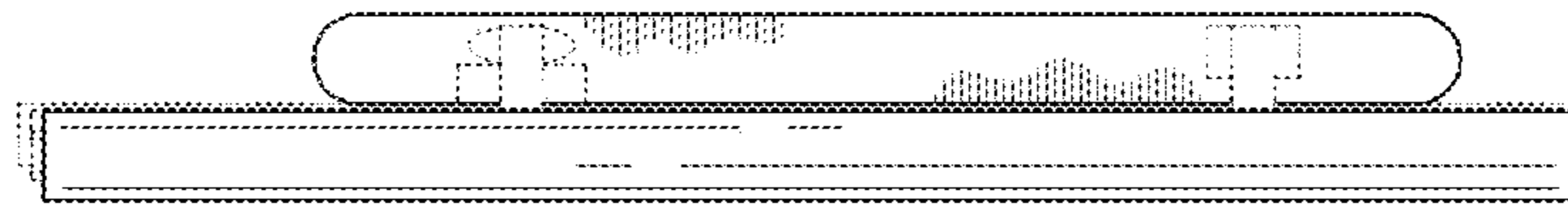

FIG. 6

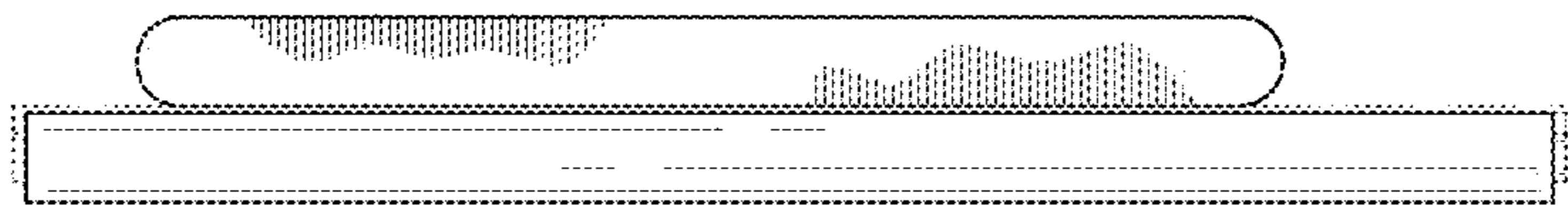

FIG. 7

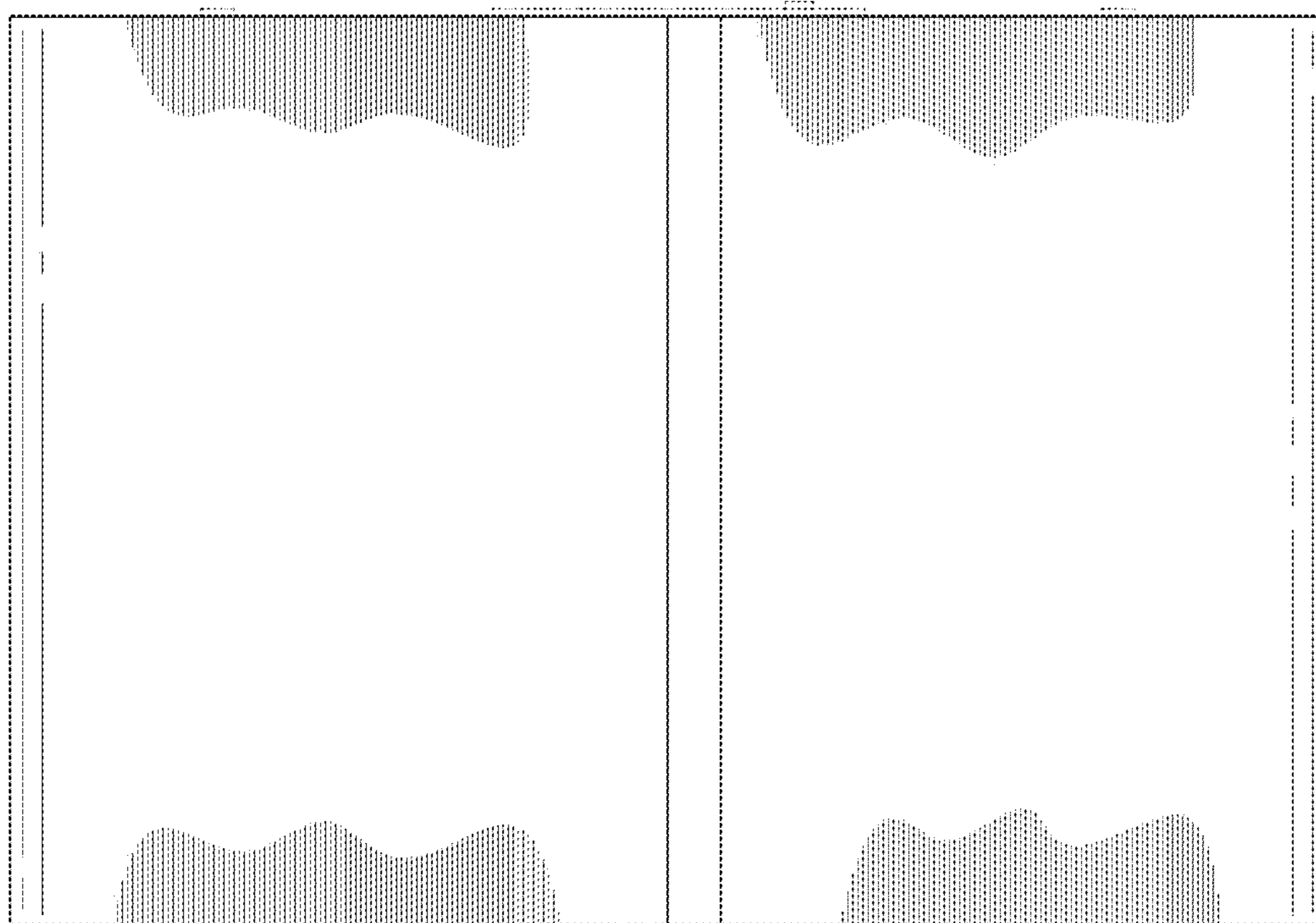

FIG. 8