



US00D700129S

(12) **United States Design Patent**
Koga

(10) **Patent No.:** **US D700,129 S**

(45) **Date of Patent:** **** Feb. 25, 2014**

(54) **HOOK FOR AUTOMOBILE**

(75) Inventor: **Toru Koga**, Hiroshima (JP)

(73) Assignee: **Nifco Inc.**, Yokohama-Shi (JP)

(**) Term: **14 Years**

(21) Appl. No.: **29/371,773**

(22) Filed: **Sep. 14, 2011**

(30) **Foreign Application Priority Data**

Mar. 15, 2011 (JP) 2011-005942

(51) **LOC (10) Cl.** **12-16**

(52) **U.S. Cl.**
USPC **D12/415**

(58) **Field of Classification Search**
USPC D12/415, 416, 417, 418, 419, 191, 106;
296/97.1, 97.2, 97.3, 97.4, 97.5, 97.6,
296/97.7, 97.8, 180.1, 137.1; 160/370.21,
160/370.23, 370.22; D9/423; 224/275;
D3/319; D8/354; D14/451-452;
248/278.1, 274.1, 284.1
See application file for complete search history.

(56) **References Cited**

U.S. PATENT DOCUMENTS

D327,865 S * 7/1992 Falcoff et al. D12/195
D360,127 S * 7/1995 Stiner D8/367
D391,251 S * 2/1998 Yuyama et al. D14/132
5,769,294 A * 6/1998 Heinz et al. 224/567

D560,592 S * 1/2008 Brassard D12/415
D586,348 S * 2/2009 Leung et al. D14/434
D592,126 S * 5/2009 da Silveira et al. D12/415
D615,023 S * 5/2010 Moburg et al. D12/415
D676,371 S * 2/2013 Son D12/415
D682,772 S * 5/2013 Massaad D12/415

* cited by examiner

Primary Examiner — Katrina A Betton

(74) *Attorney, Agent, or Firm* — Manabu Kanesaka

(57) **CLAIM**

The ornamental design for a hook for automobile, as shown and described.

DESCRIPTION

FIG. 1 is a front view of a hook for automobile showing my new design;
FIG. 2 is a rear view thereof;
FIG. 3 is a left side view thereof; a right side view being symmetrical to the left side view;
FIG. 4 is a top plan view thereof;
FIG. 5 is a bottom view thereof;
FIG. 6 is a perspective view thereof;
FIG. 7 is a cross-sectional view thereof taken along the line 7-7 in FIG. 1;
FIG. 8 is a cross-sectional view thereof taken along the line 8-8 in FIG. 1; and,
FIG. 9 is a perspective view thereof showing the used condition.

1 Claim, 4 Drawing Sheets

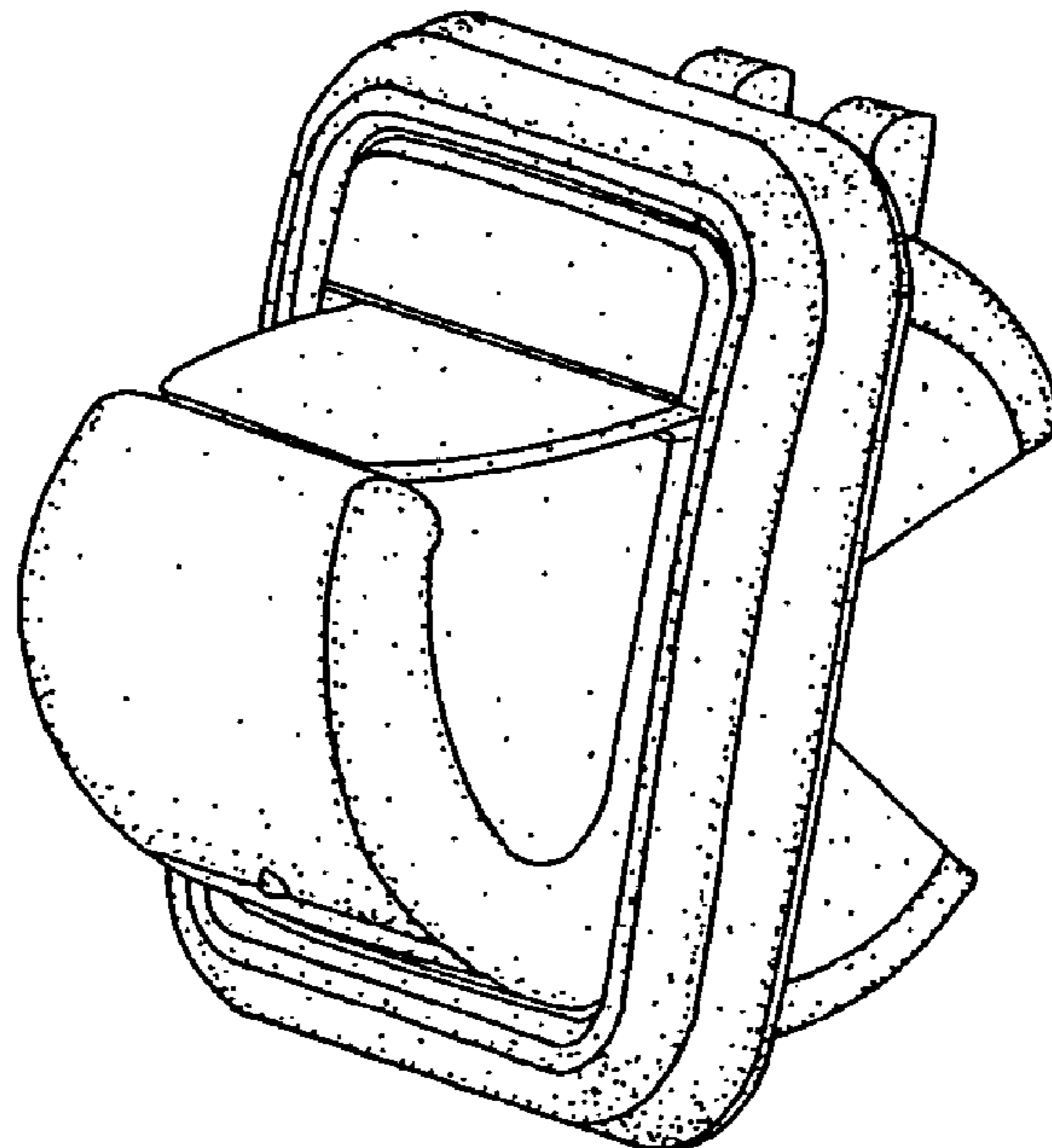

FIG. 1

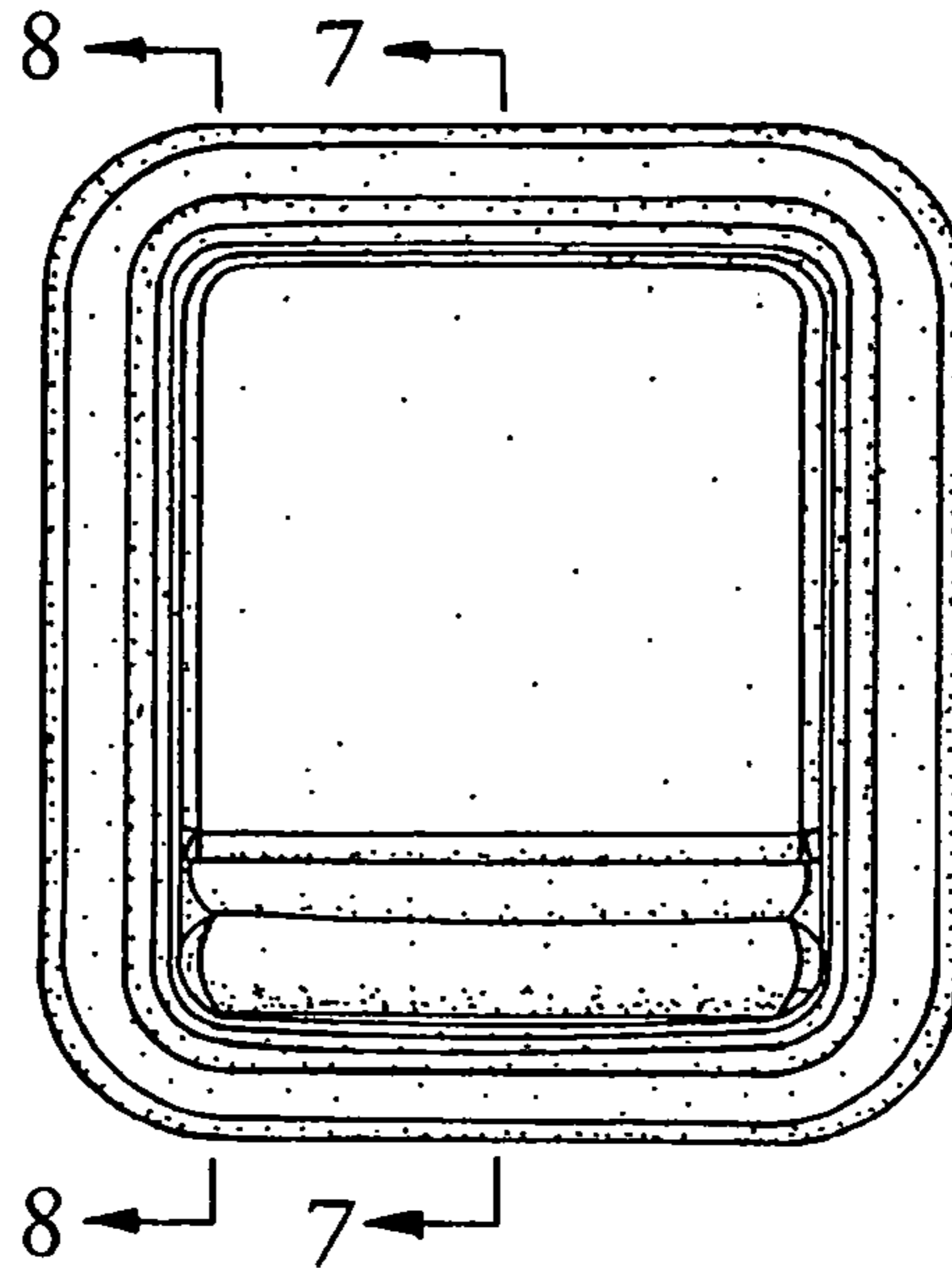

FIG. 2

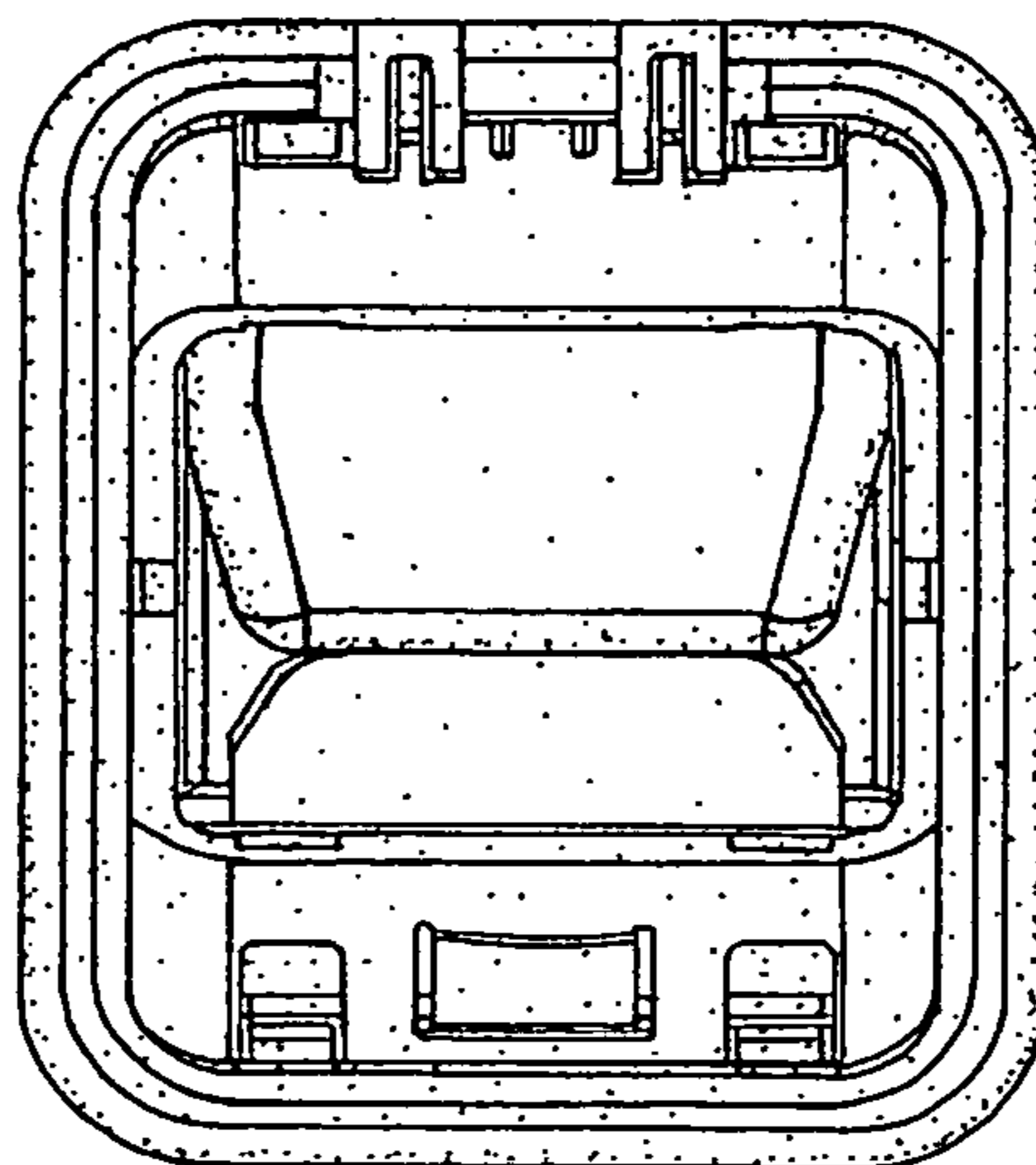

FIG. 3

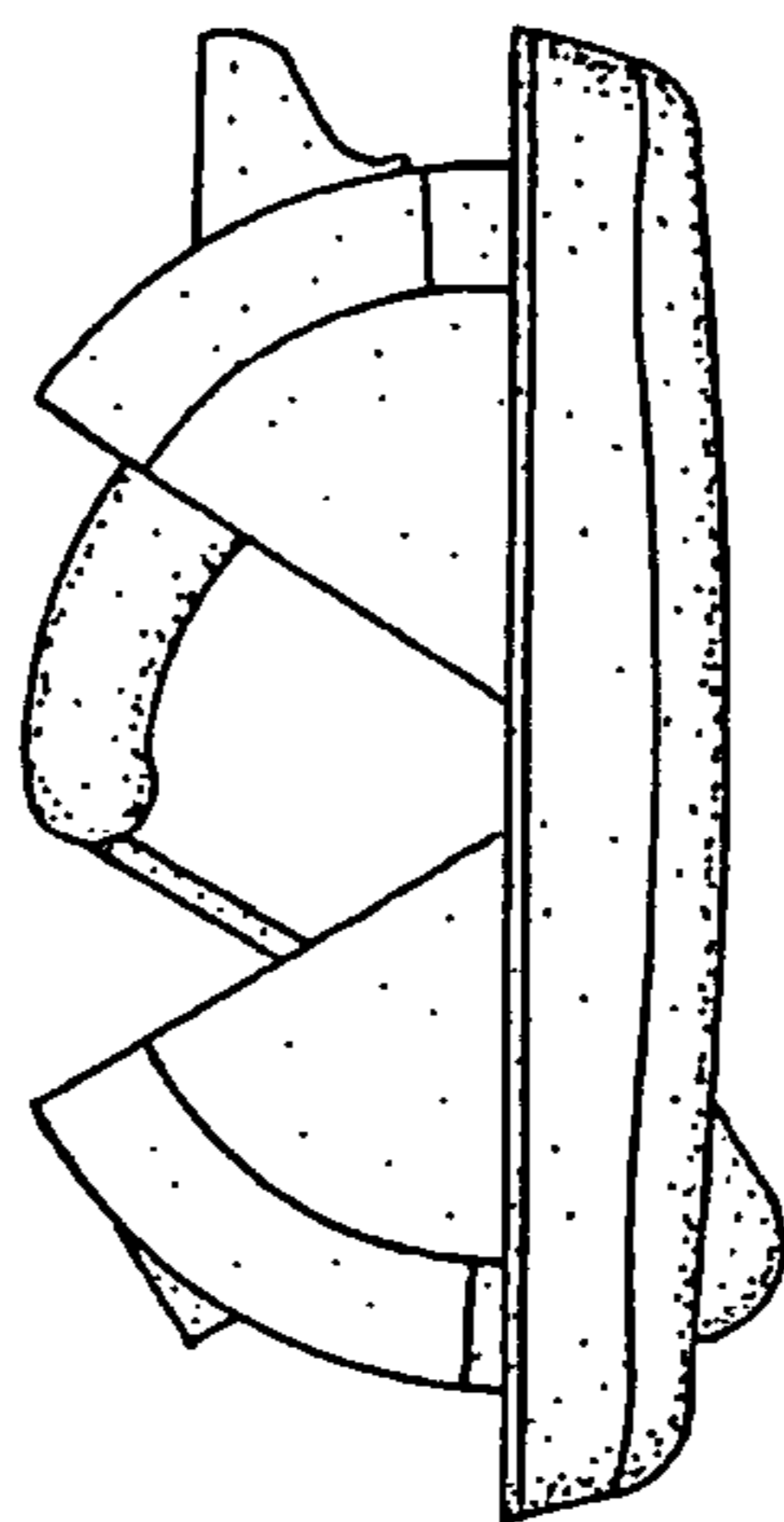

FIG. 4

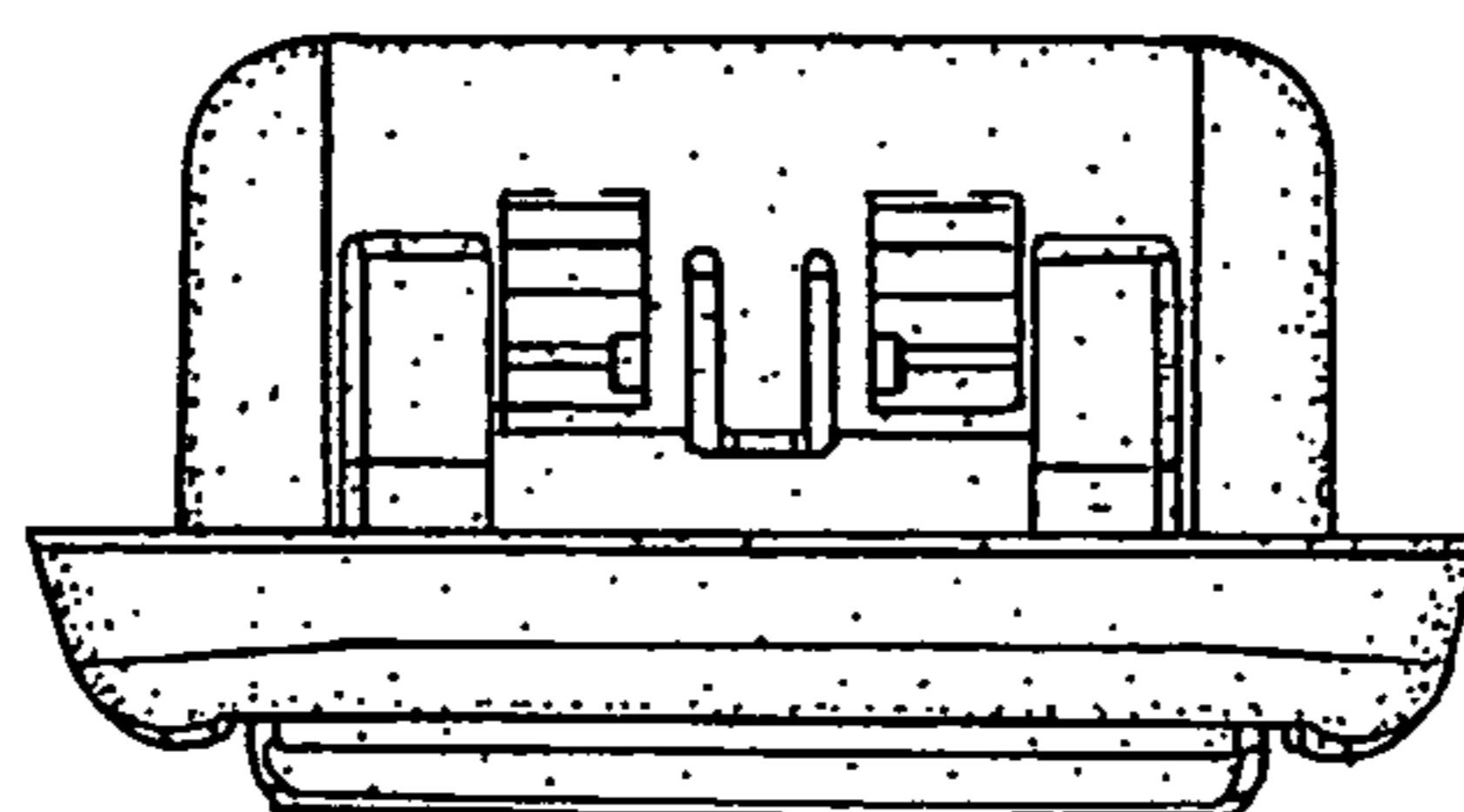

FIG. 5

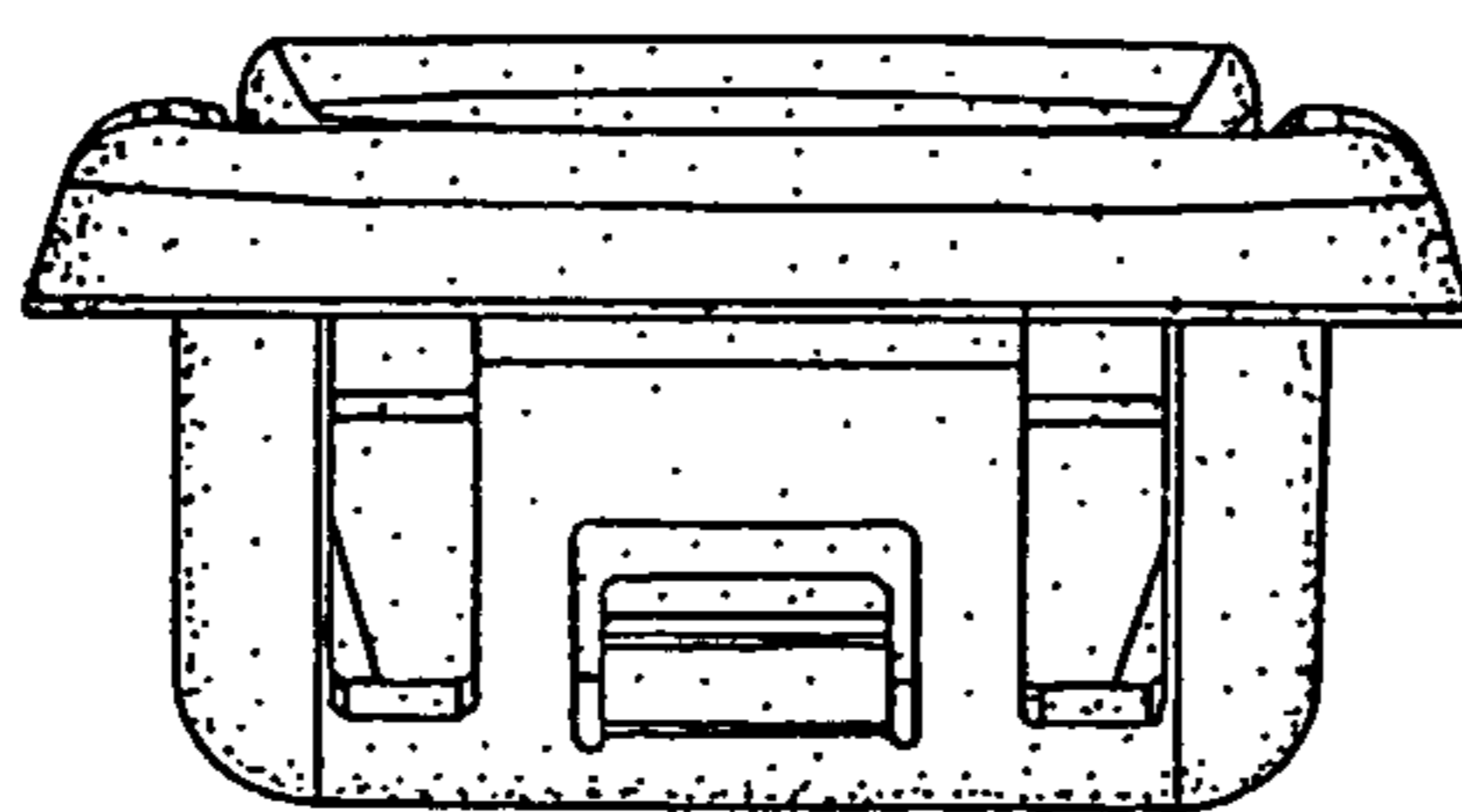

FIG. 6

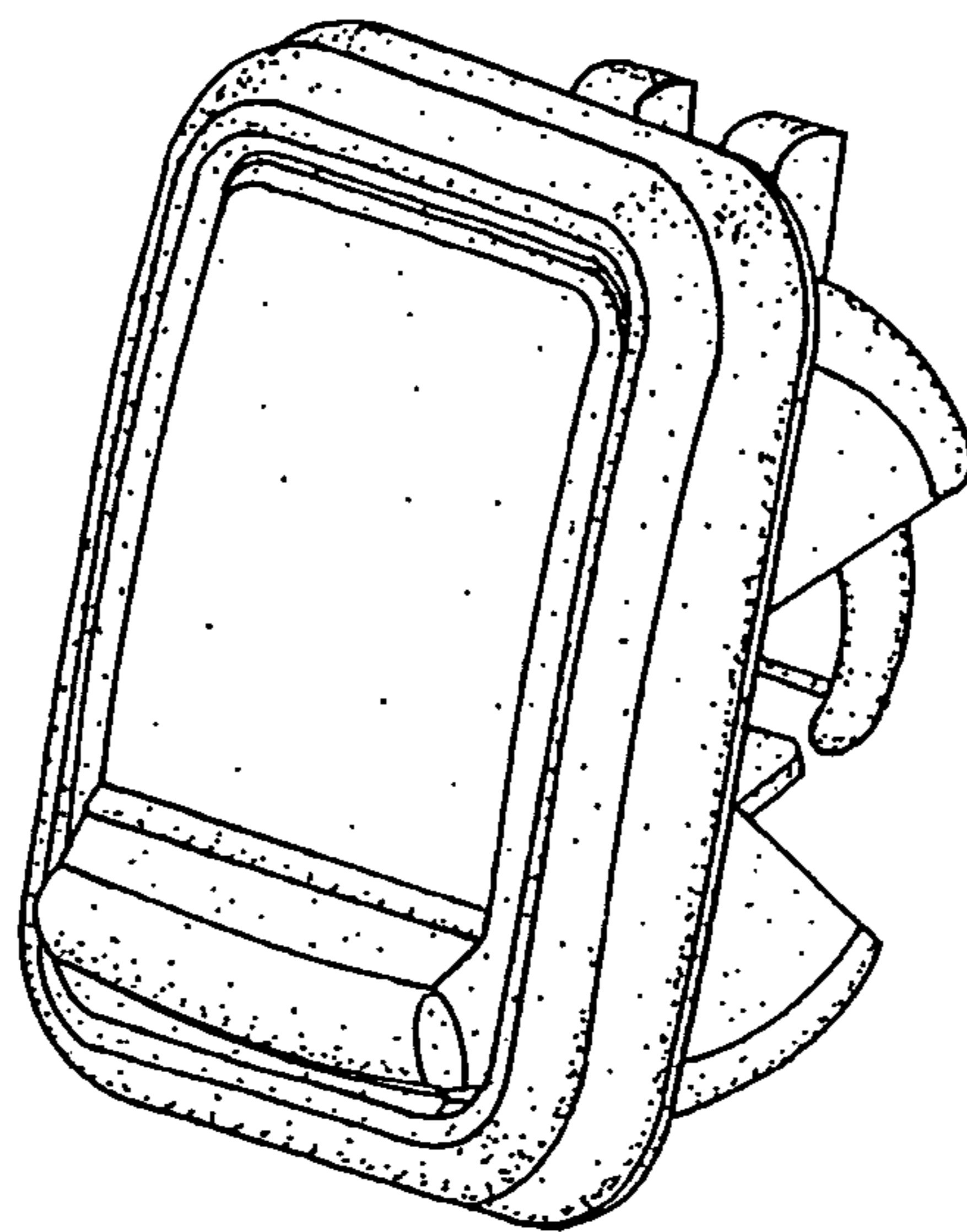

FIG. 7

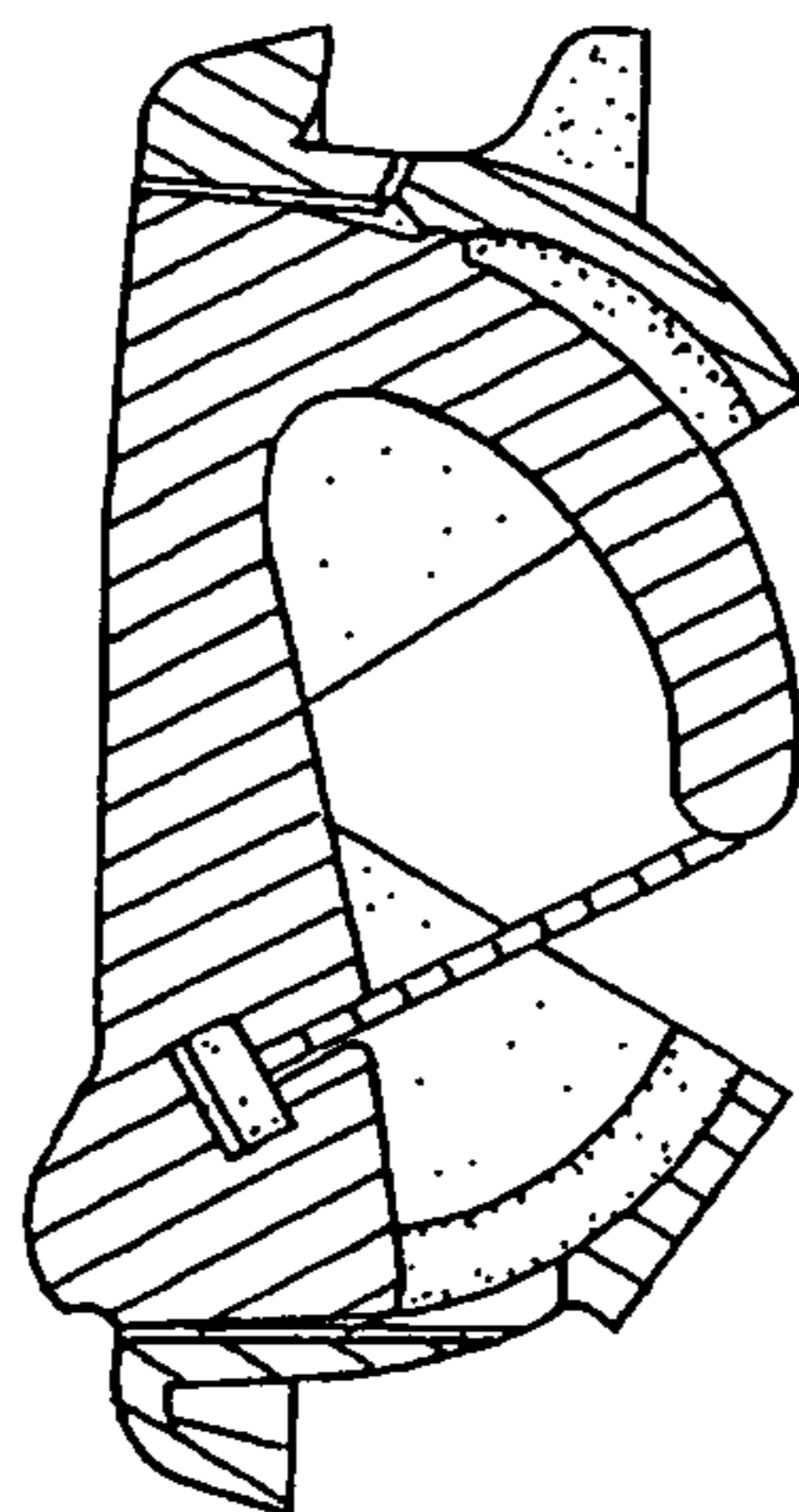

FIG. 8

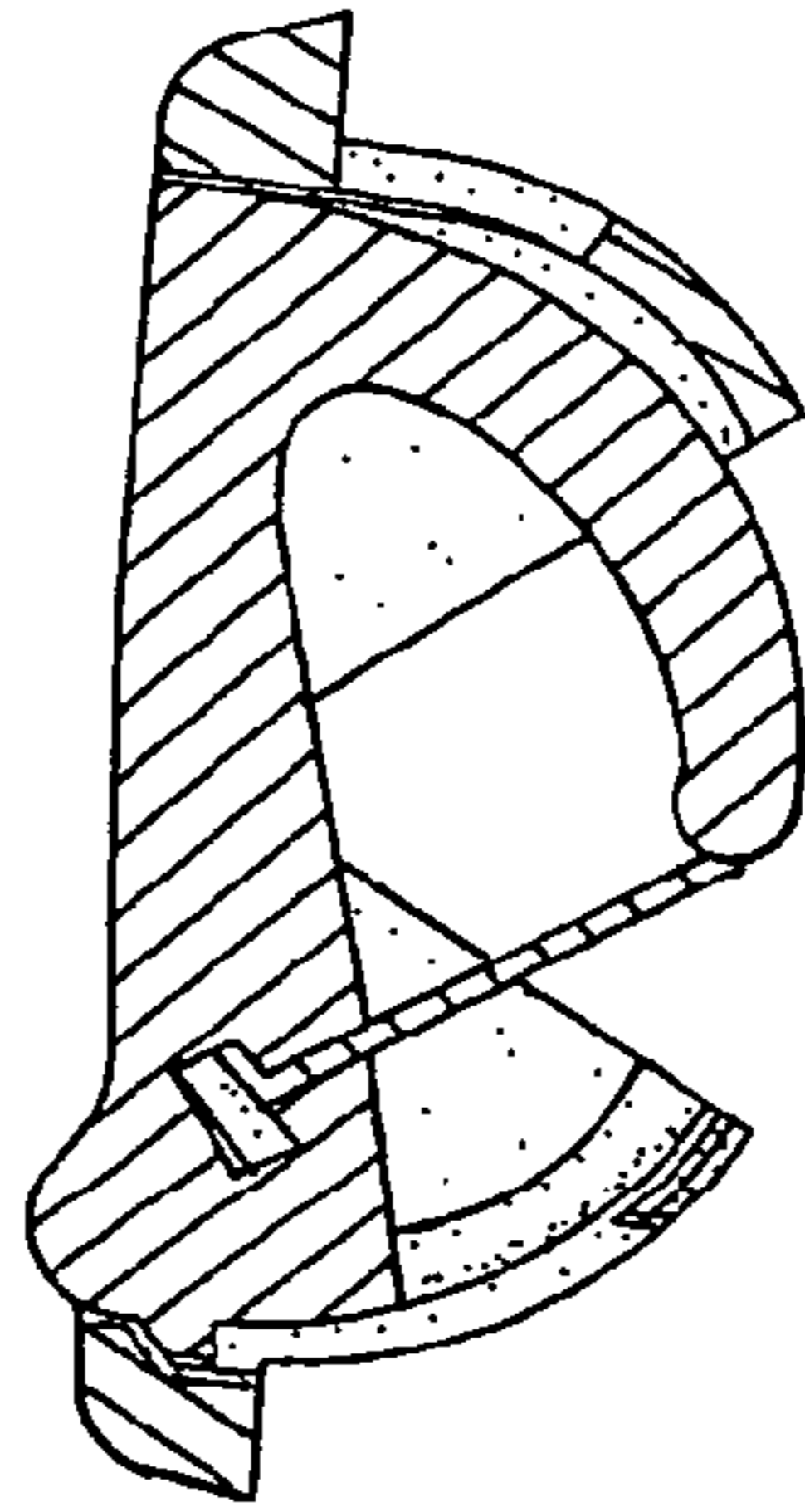

FIG. 9

