

US00D699983S

(12) **United States Design Patent**  
**Polesuk**

(10) **Patent No.:** **US D699,983 S**

(45) **Date of Patent:** **\*\* Feb. 25, 2014**

(54) **FITTED FLAT SHEET**

(71) Applicant: **Peri Polesuk**, Scarsdale, NY (US)

(72) Inventor: **Peri Polesuk**, Scarsdale, NY (US)

(\*\*) Term: **14 Years**

(21) Appl. No.: **29/473,256**

(22) Filed: **Nov. 20, 2013**

(51) **LOC (10) Cl.** ..... **06-09**

(52) **U.S. Cl.**  
USPC ..... **D6/602**

(58) **Field of Classification Search**  
USPC ..... D6/595, 596, 602; 5/482, 495-497  
See application file for complete search history.

(56) **References Cited**

**U.S. PATENT DOCUMENTS**

2,498,055	A	2/1950	Veit	
2,695,414	A *	11/1954	Ford et al.	5/485
3,962,739	A	6/1976	Crockett	
4,035,854	A	7/1977	Pardee	
4,045,931	A	9/1977	Becker	
4,237,805	A	12/1980	Ferrante et al.	
4,241,466	A	12/1980	Mendyk	
4,386,439	A	6/1983	Roccograndi et al.	
4,461,048	A	7/1984	Allaire, Jr.	
4,903,360	A *	2/1990	Friedman	5/485
4,964,184	A *	10/1990	Lewis	5/496

D334,319	S *	3/1993	Nation	D6/603
D383,028	S *	9/1997	Pierce	D6/602
6,049,925	A	4/2000	Lewis	
6,108,836	A	8/2000	Keene, III	
7,140,053	B1	11/2006	Mangano	
7,487,561	B2	2/2009	Ho	
8,370,974	B2	2/2013	Caines	
D691,399	S *	10/2013	Jalan	D6/602

\* cited by examiner

*Primary Examiner* — Janice Seeger

(74) *Attorney, Agent, or Firm* — Andrew F. Young, Esq.;  
Lackebach Siegel, LLP

(57) **CLAIM**

The ornamental design for a fitted flat sheet, as shown and described.

**DESCRIPTION**

FIG. 1 is a front side perspective view of the present invention, shown as if fitted on a mattress, albeit above the mattress for illustrative purposes.

FIG. 2 is a top plan view of FIG. 1.

FIG. 3 is a bottom plan view of FIG. 1.

FIG. 4 is a front elevation view of FIG. 1.

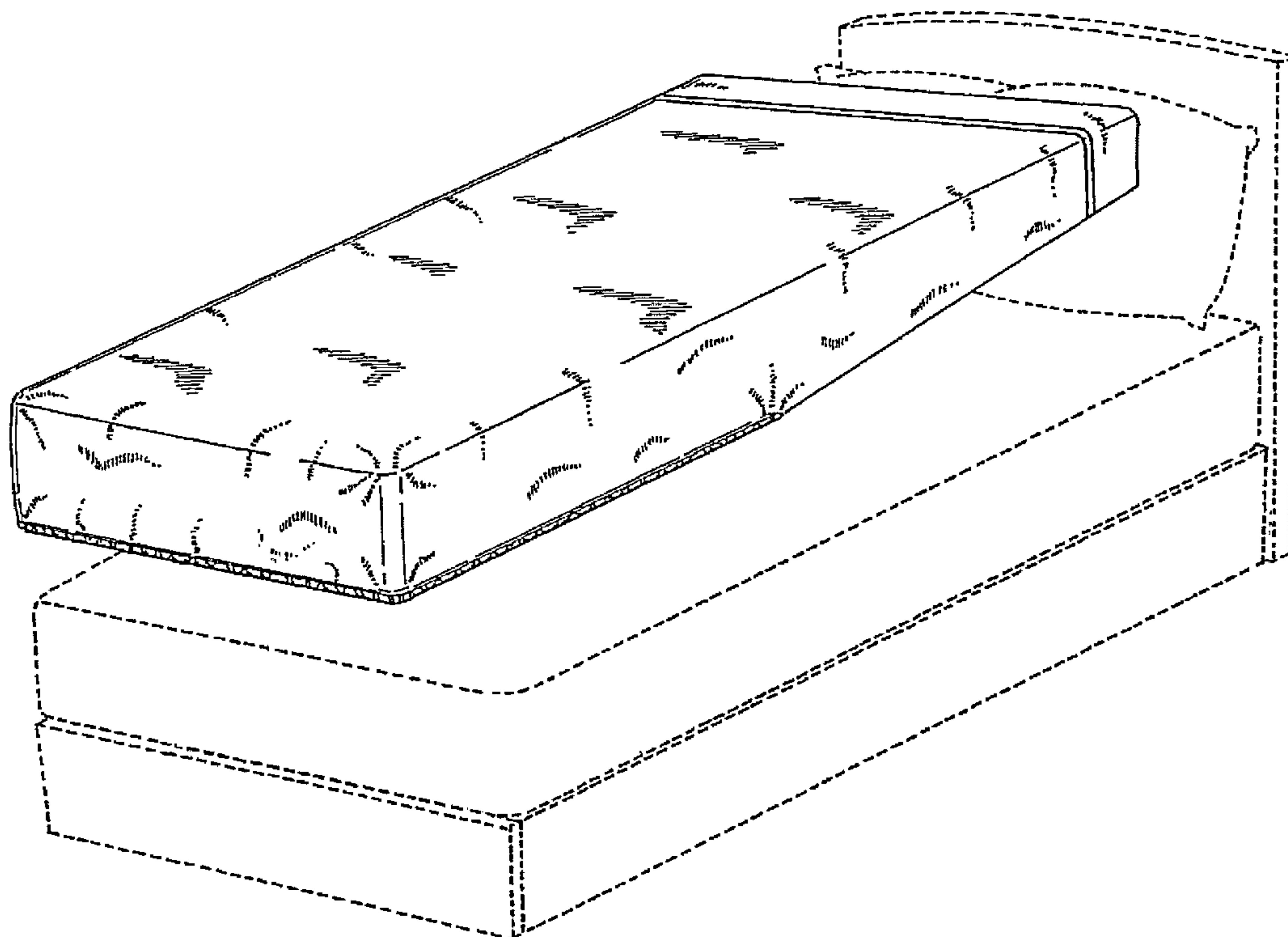
FIG. 5 is a rear elevation view of FIG. 1.

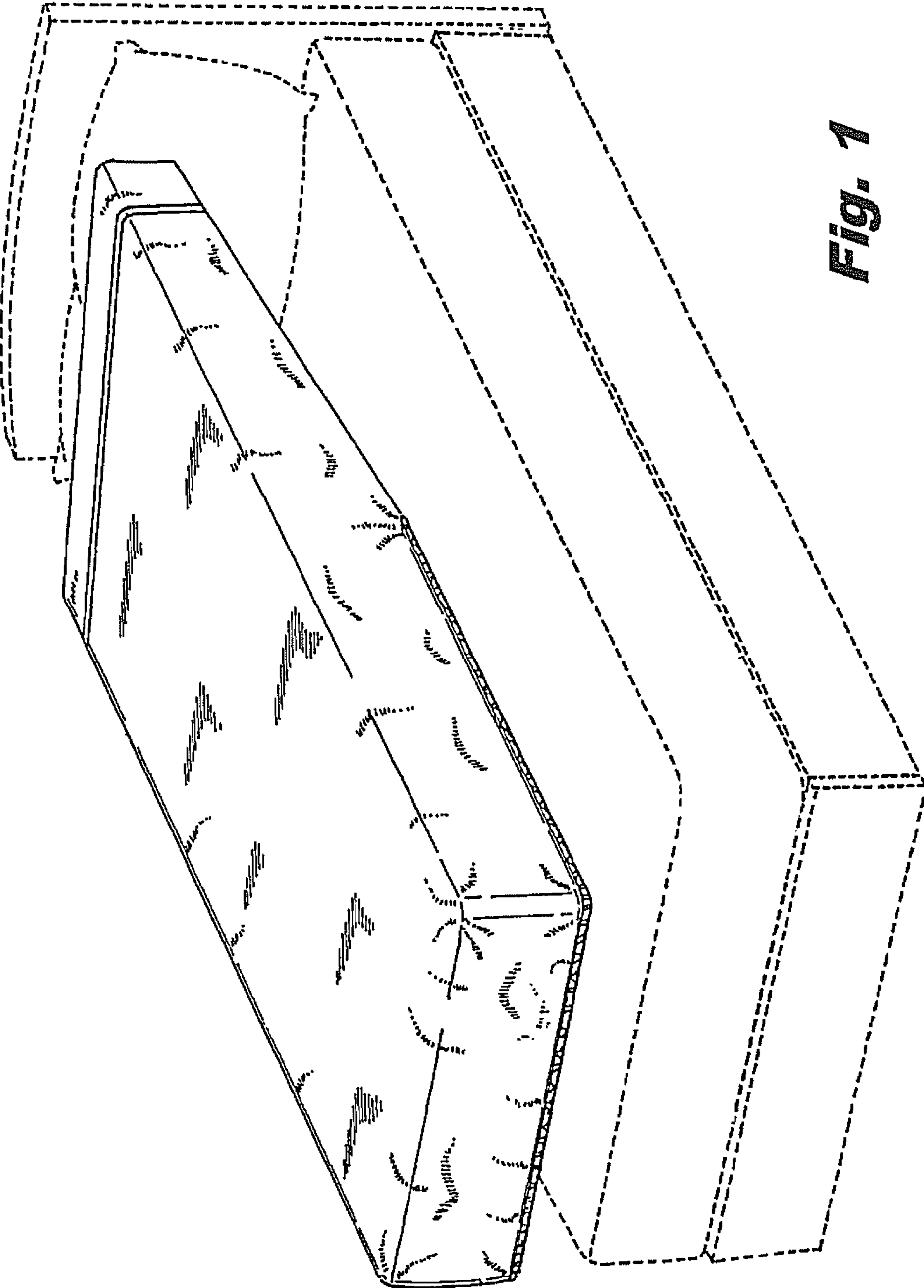
FIG. 6 is a left side elevation view of FIG. 1; and,

FIG. 7 is a right side elevation view of FIG. 1.

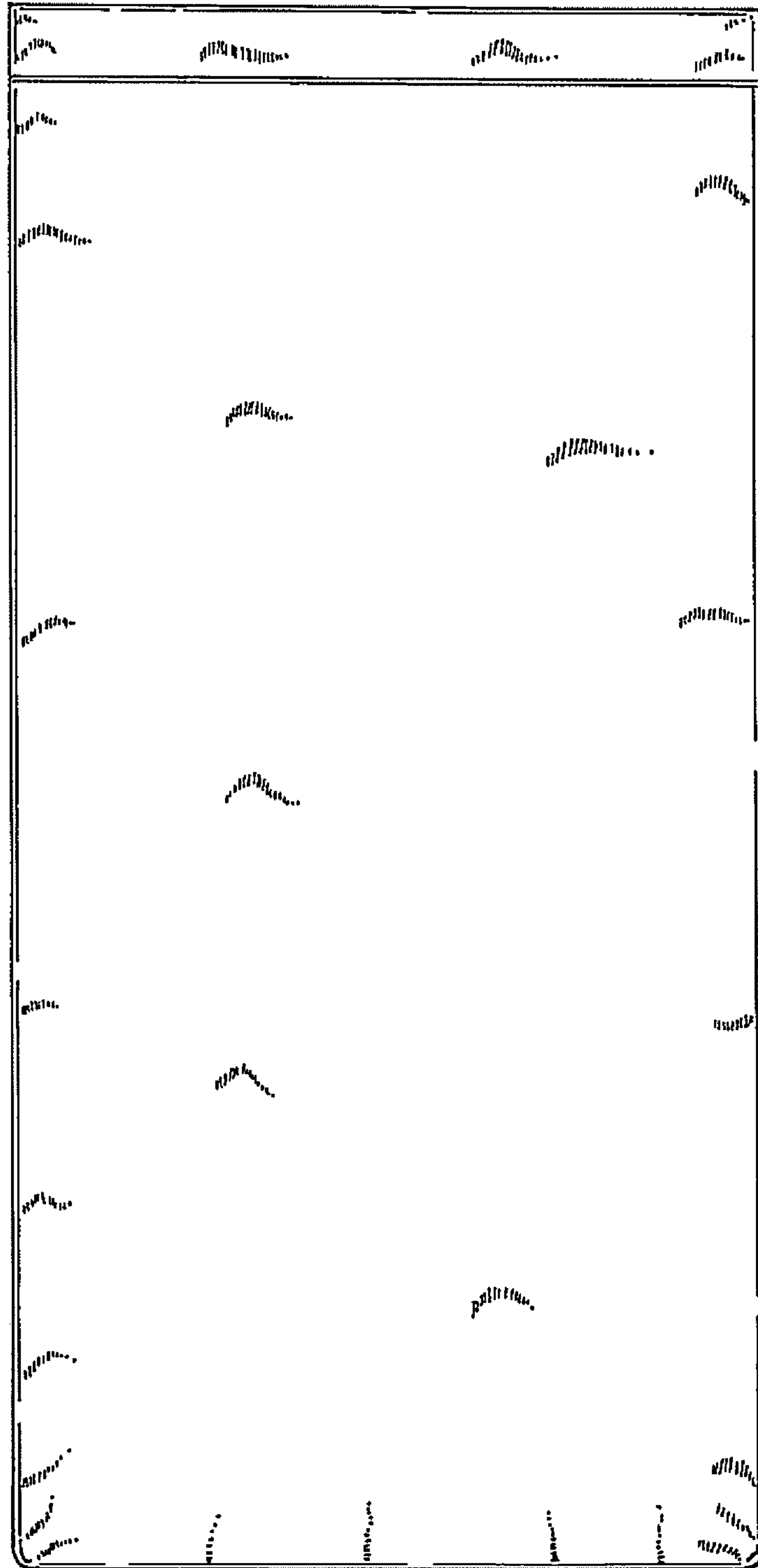
No claim is made to the dashed line regions on the drawings, including the bed and mattress arrangement which are shown only for display purposes and form no part of the claimed design.

**1 Claim, 4 Drawing Sheets**

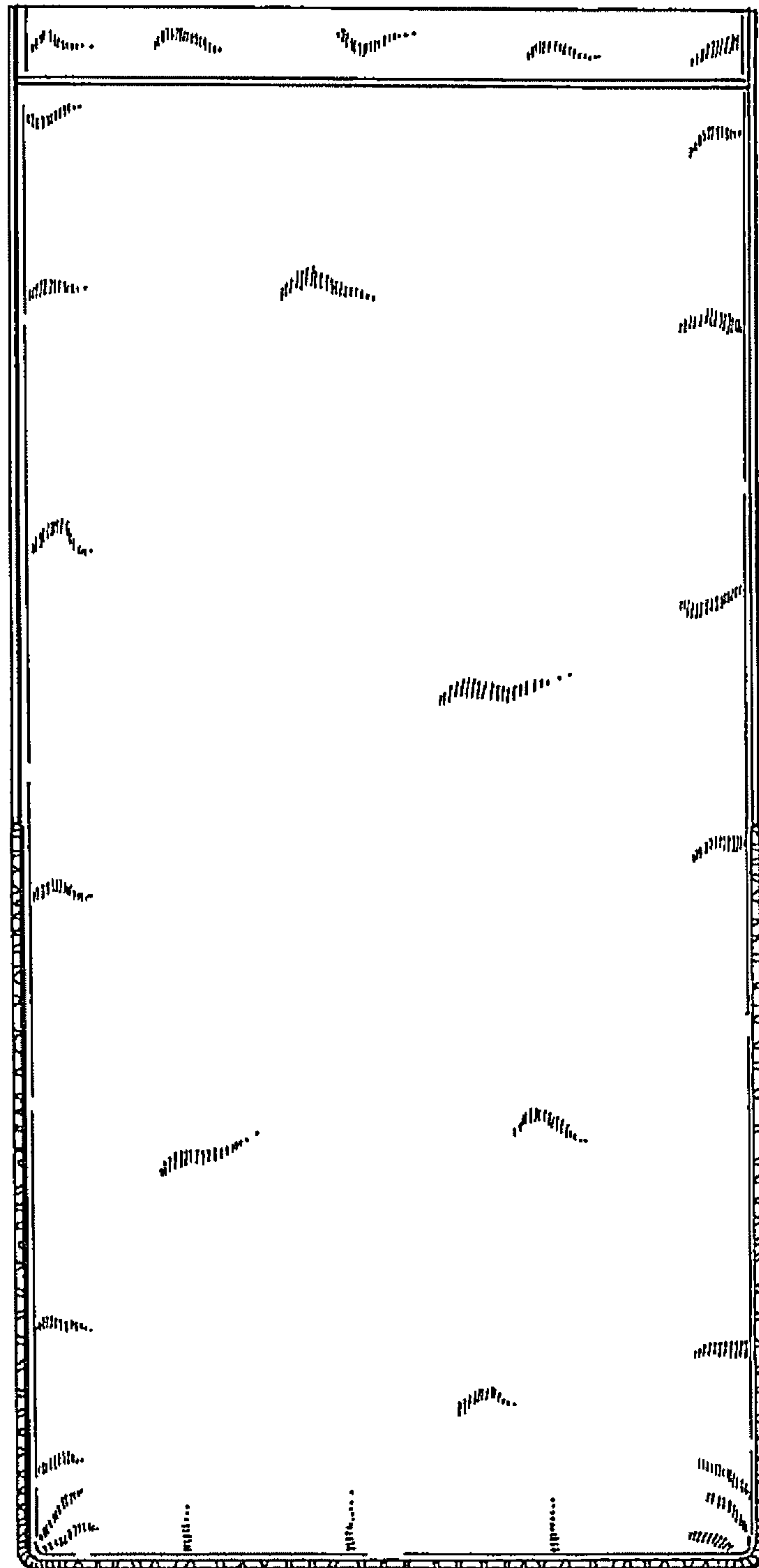




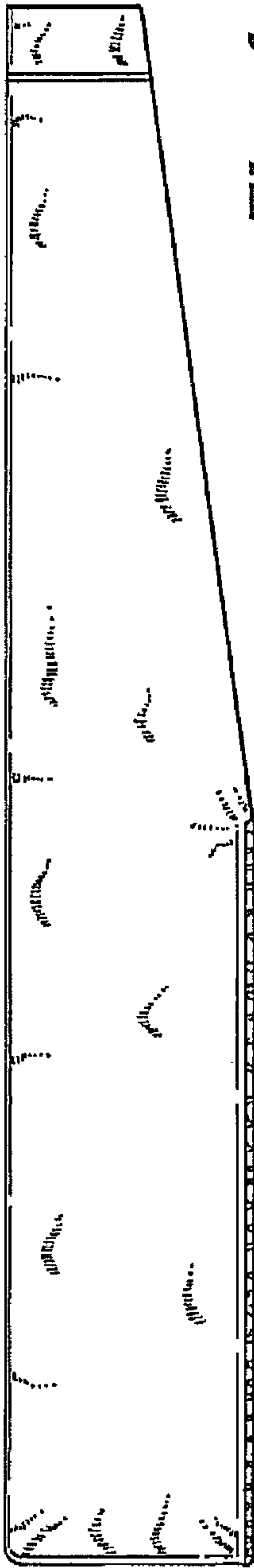
**Fig. 1**



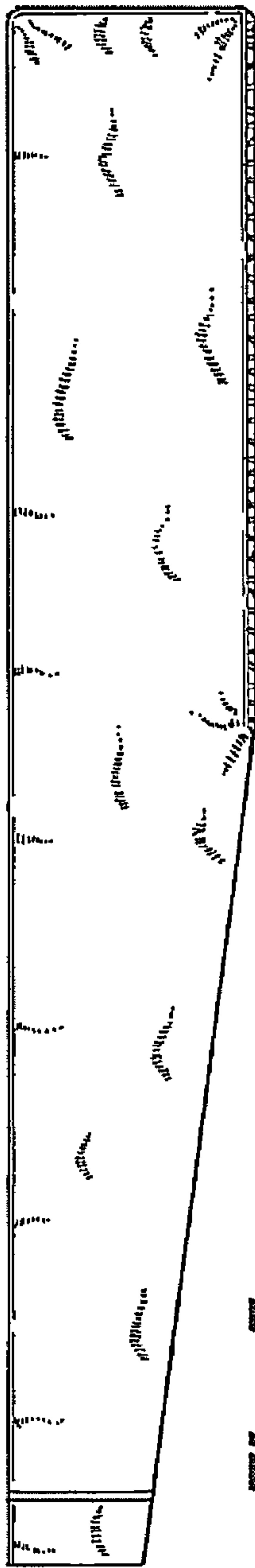
**Fig. 2**



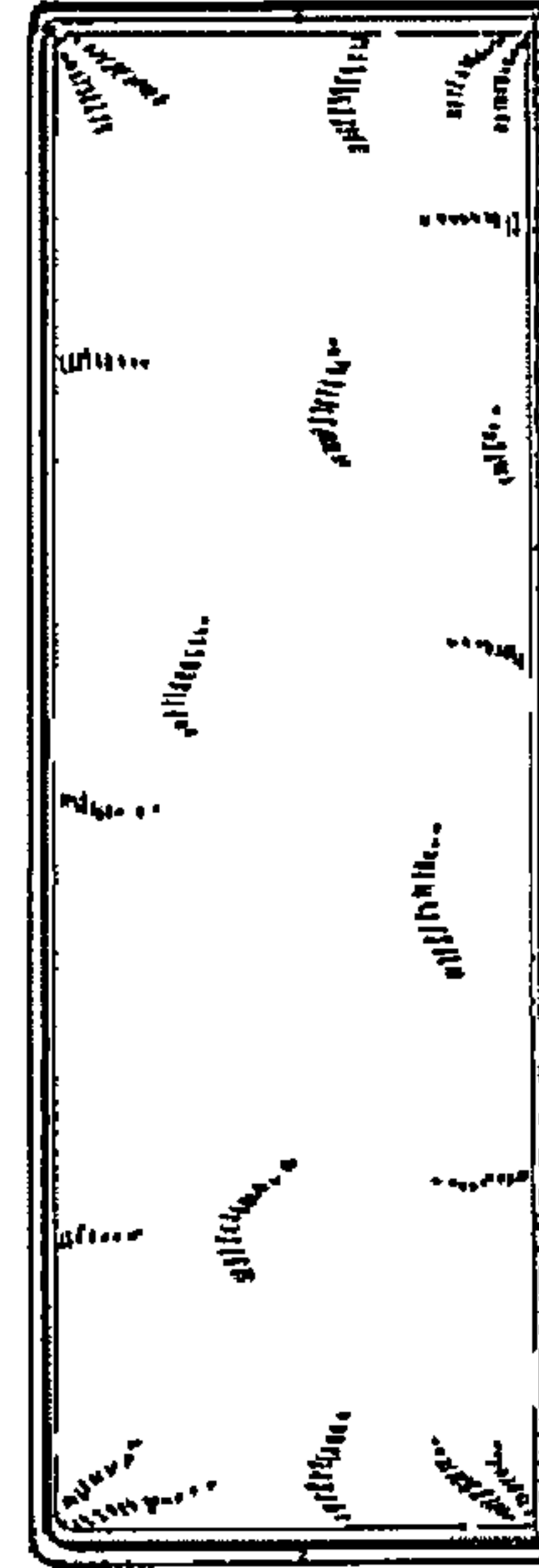
**Fig. 3**



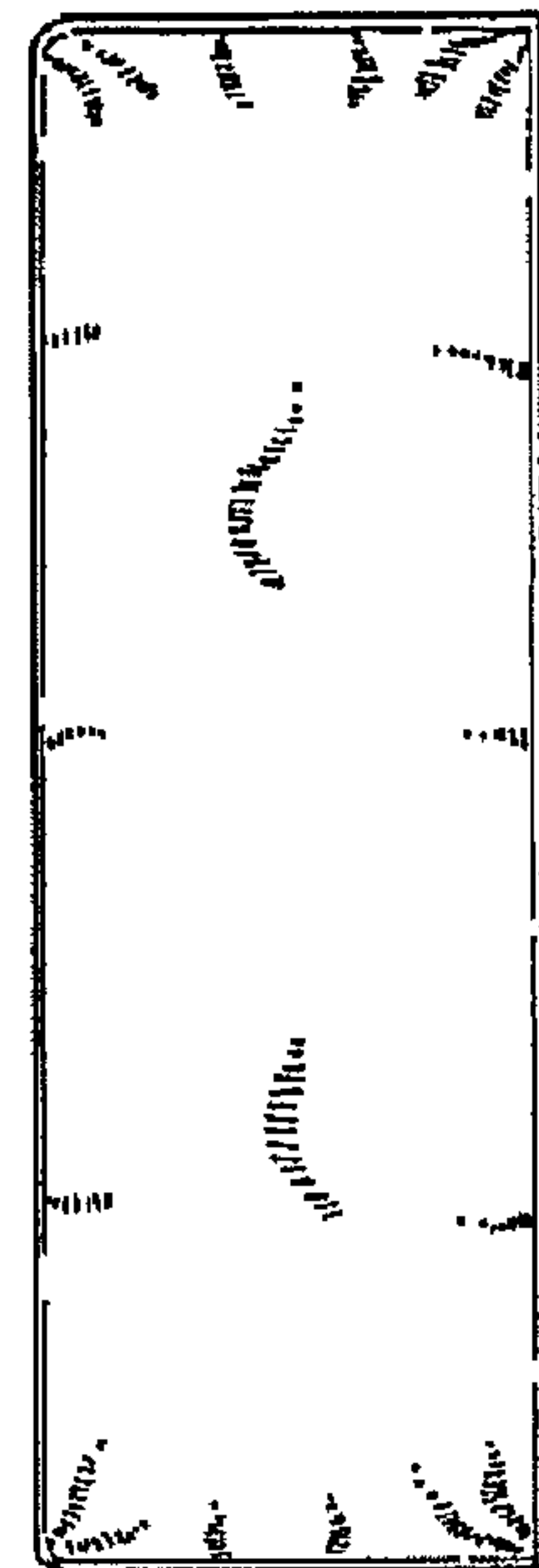
**Fig. 4**



**Fig. 5**



**Fig. 7**



**Fig. 6**