



US00D699977S

(12) **United States Design Patent**
Malekpour

(10) **Patent No.:** **US D699,977 S**

(45) **Date of Patent:** **** Feb. 25, 2014**

(54) **ADAPTOR FOR A BLIND SYSTEM**

(71) Applicant: **Gholamali Malekpour**, San Diego, CA
(US)

(72) Inventor: **Gholamali Malekpour**, San Diego, CA
(US)

(**) Term: **14 Years**

(21) Appl. No.: **29/461,963**

(22) Filed: **Jul. 30, 2013**

(51) **LOC (10) Cl.** **06-10**

(52) **U.S. Cl.**
USPC **D6/580**

(58) **Field of Classification Search**
USPC D6/575, 577, 579, 580; D8/349, 368,
D8/369, 376, 382; 160/84.01-84.08, 107,
160/108, 111, 113, 130, 133, 176.1 P, 237,
160/330, DIG. 6, 902; 248/252, 266, 271
See application file for complete search history.

(56) **References Cited**

U.S. PATENT DOCUMENTS

789,875	A *	5/1905	Palmer	248/266
884,656	A *	4/1908	Green	248/252
1,530,276	A *	3/1925	Mehalska	248/252

1,790,312	A *	1/1931	Leeper et al.	248/264
2,382,887	A *	8/1945	Letoile	248/252
4,607,818	A *	8/1986	Georgopoulos	248/544
5,012,850	A *	5/1991	Schrader	160/38
5,044,589	A *	9/1991	Milne et al.	248/265
D491,054	S *	6/2004	Caterinacci, Jr.	D8/381
7,322,552	B1 *	1/2008	Lin	248/252
D678,754	S *	3/2013	Burr	D8/366
D685,253	S *	7/2013	Hiebert	D8/354
2012/0000616	A1 *	1/2012	DeWees et al.	160/330
2012/0193035	A1	8/2012	Malekpour	

* cited by examiner

Primary Examiner — Karen S Acker

(57) **CLAIM**

The ornamental design for an adaptor for a blind system, as shown.

DESCRIPTION

FIG. 1 is a perspective view of an adaptor for a blind system;
FIG. 2 is a front view thereof;
FIG. 3 is a rear view thereof;
FIG. 4 is a left side view thereof;
FIG. 5 is a right side view thereof;
FIG. 6 is a top view thereof; and,
FIG. 7 is a bottom view thereof.

1 Claim, 6 Drawing Sheets

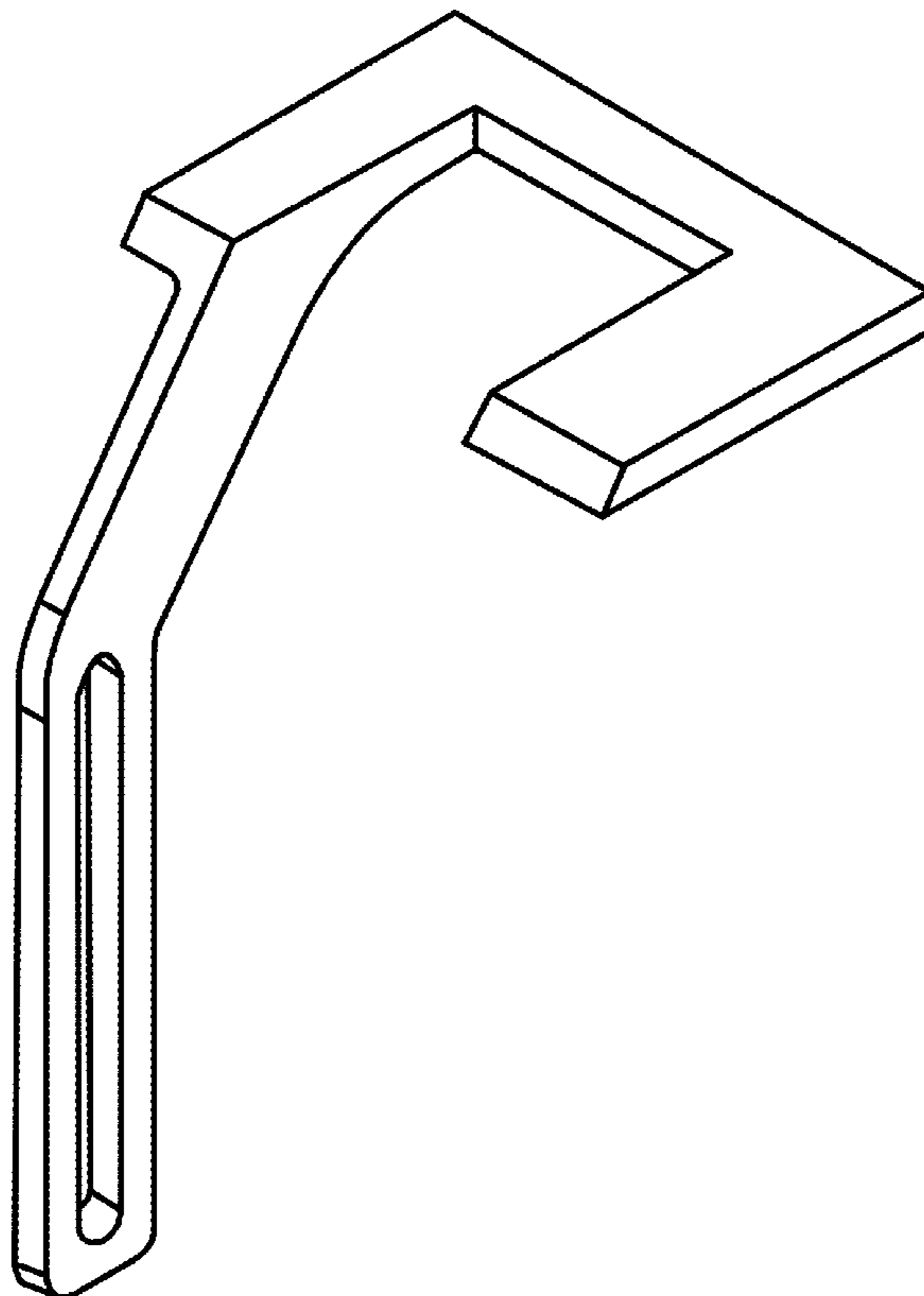

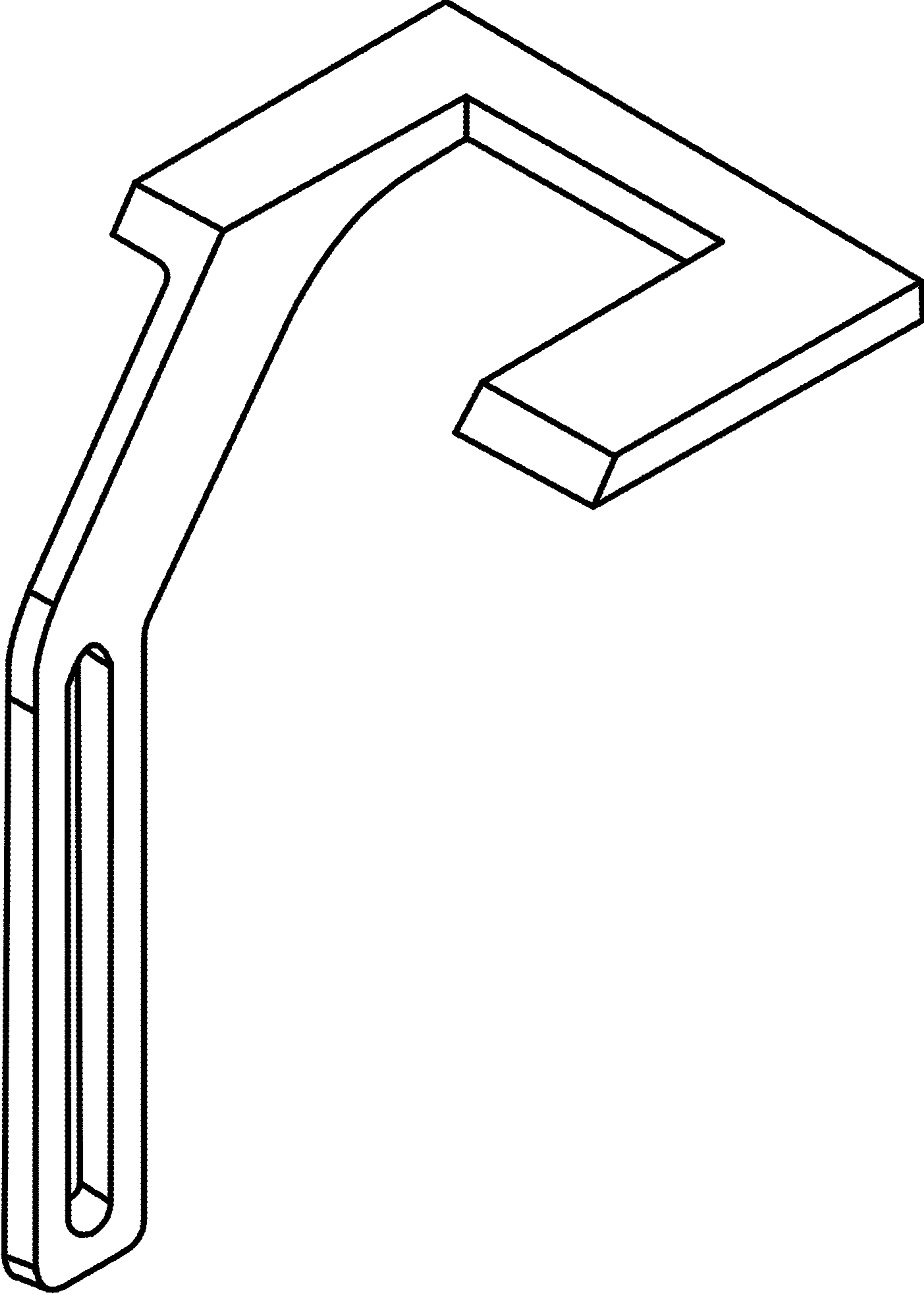

FIGURE 1

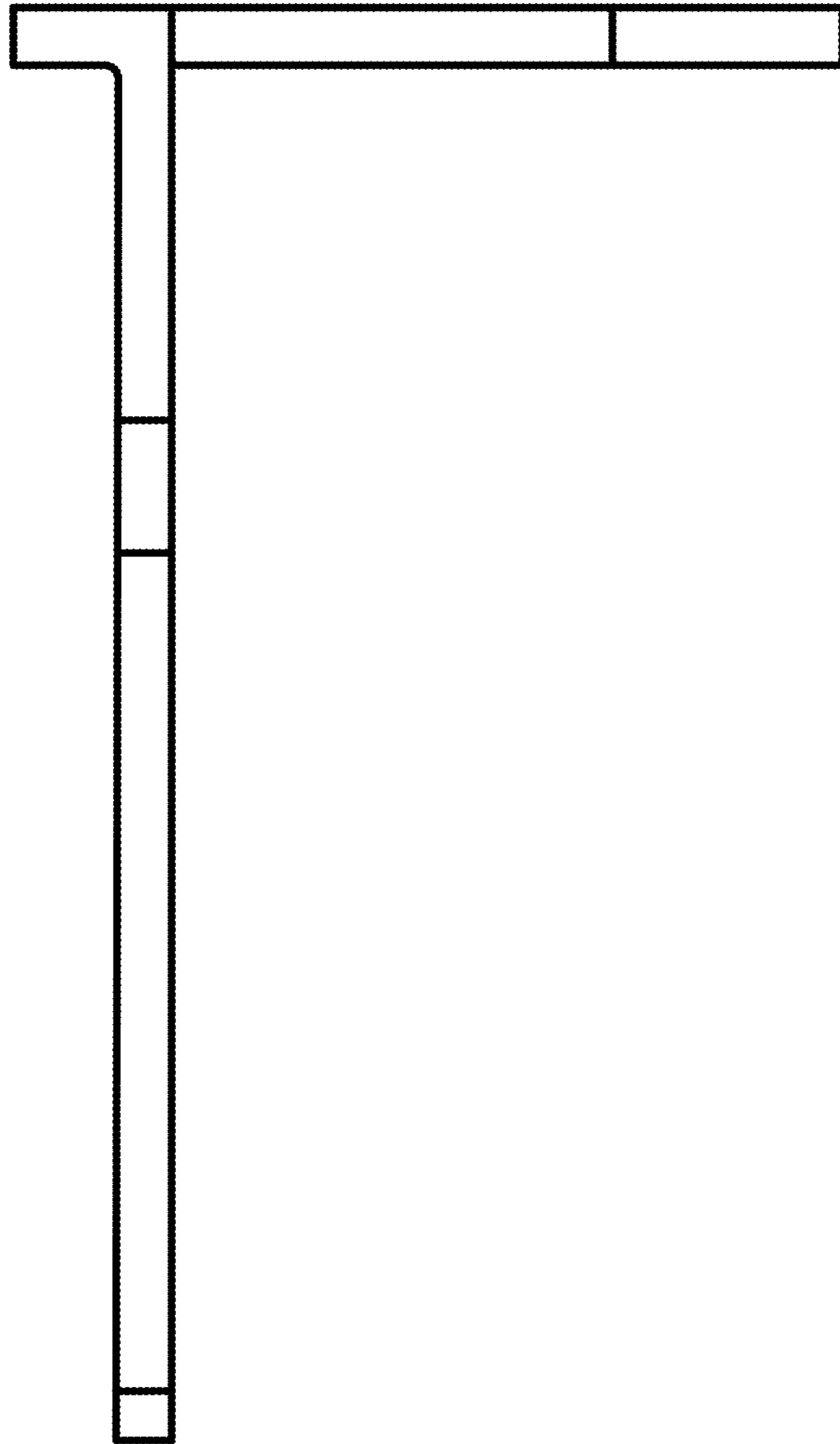

FIGURE 2

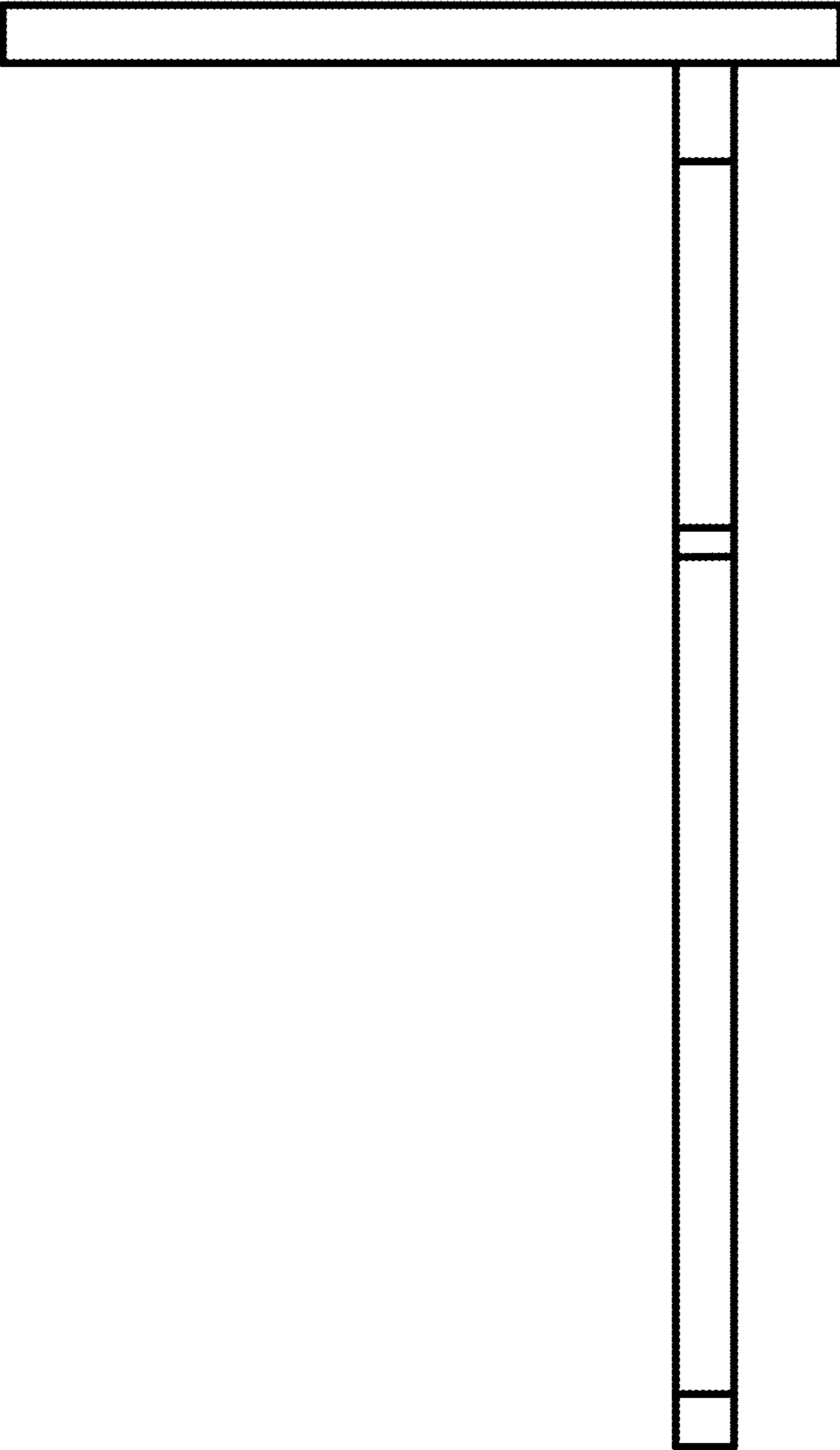

FIGURE 3

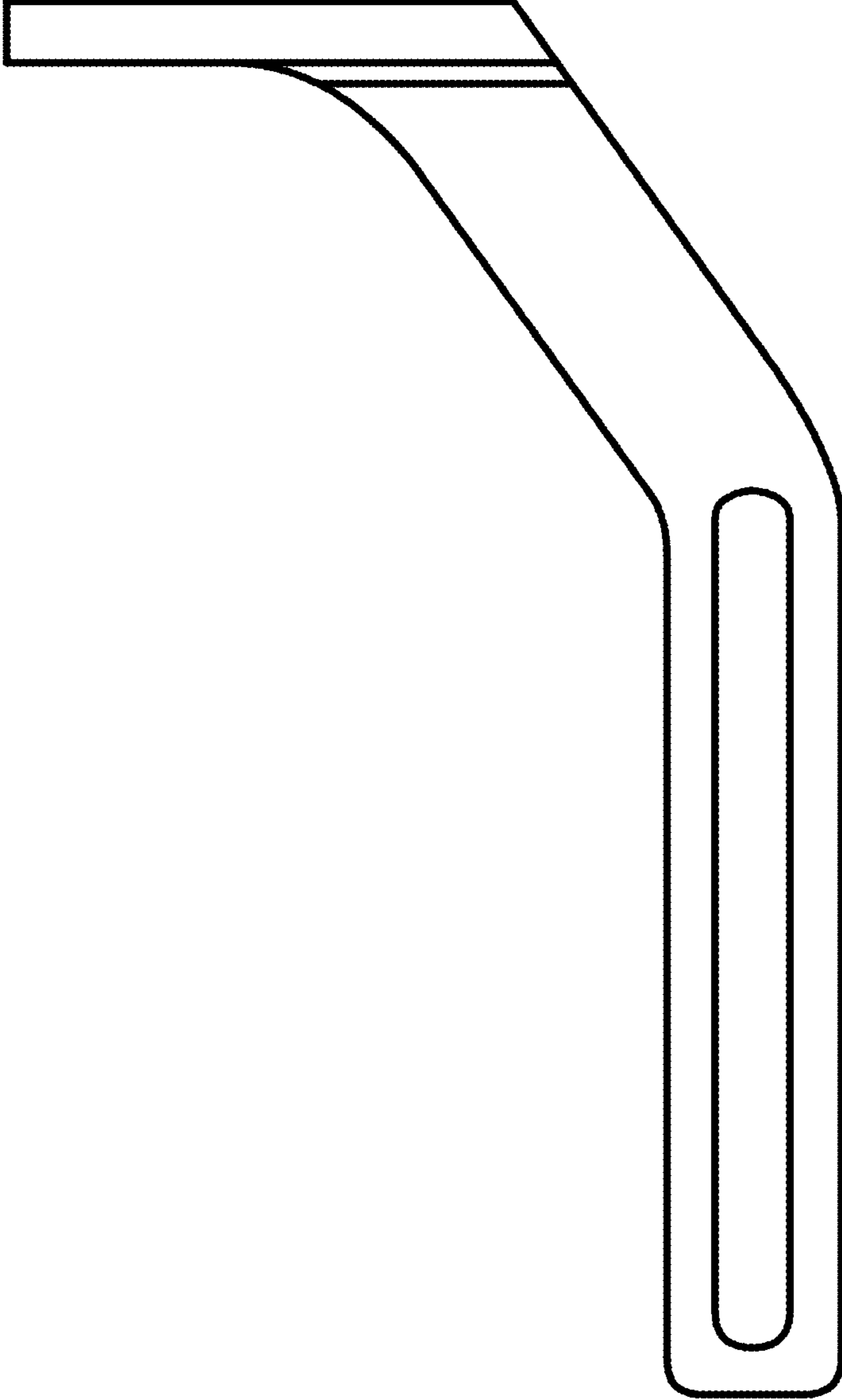

FIGURE 4

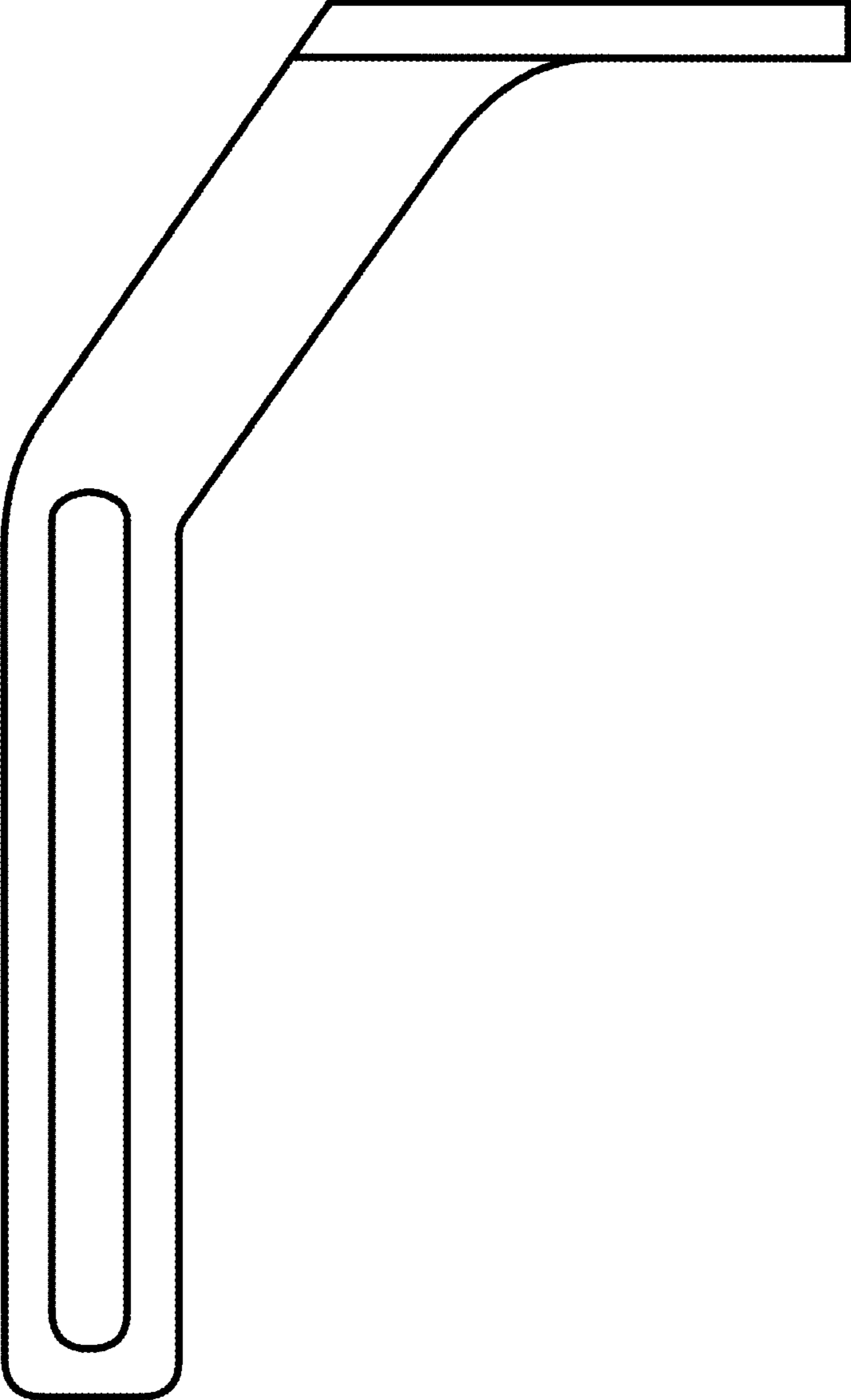

FIGURE 5

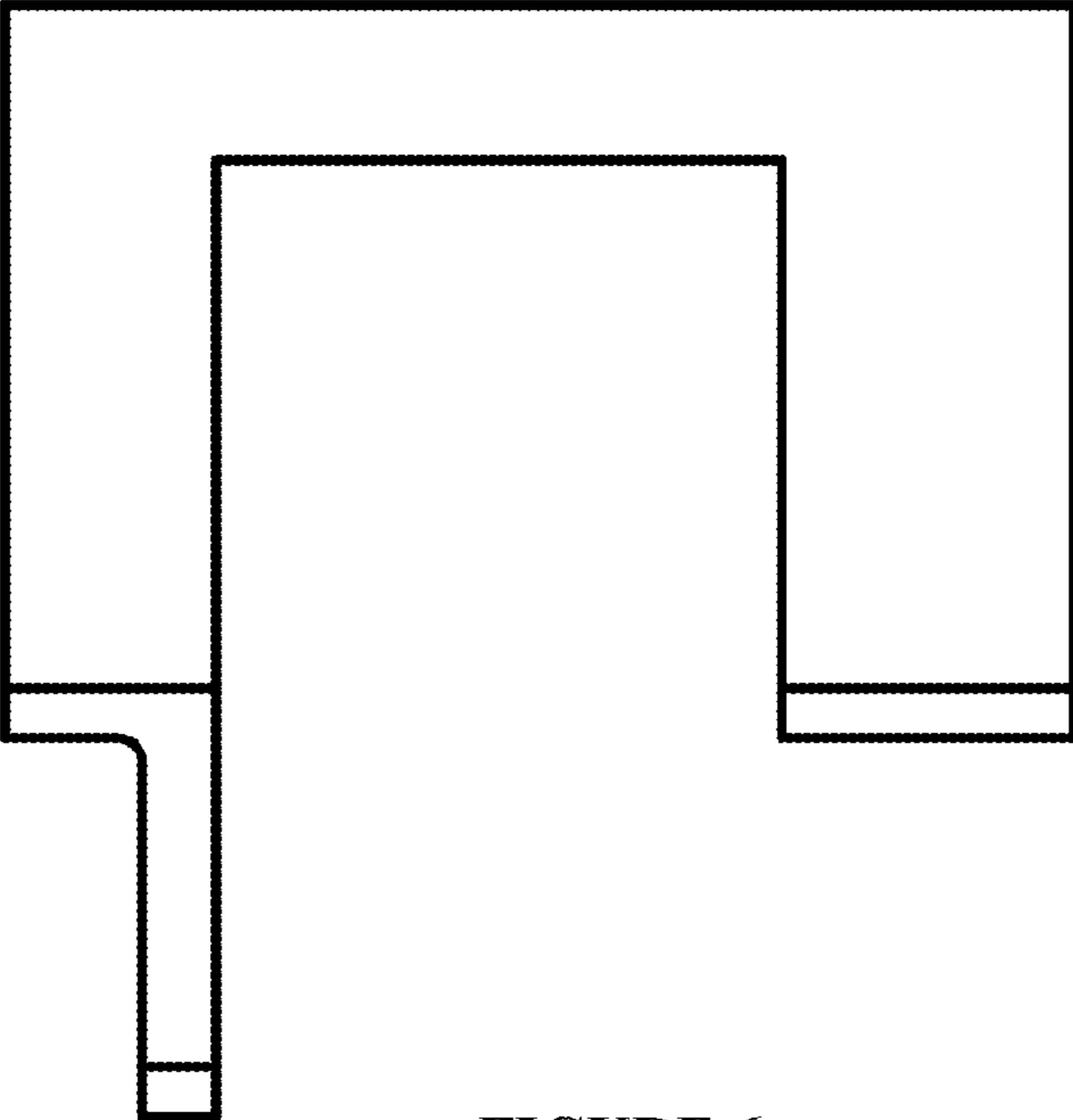

FIGURE 6

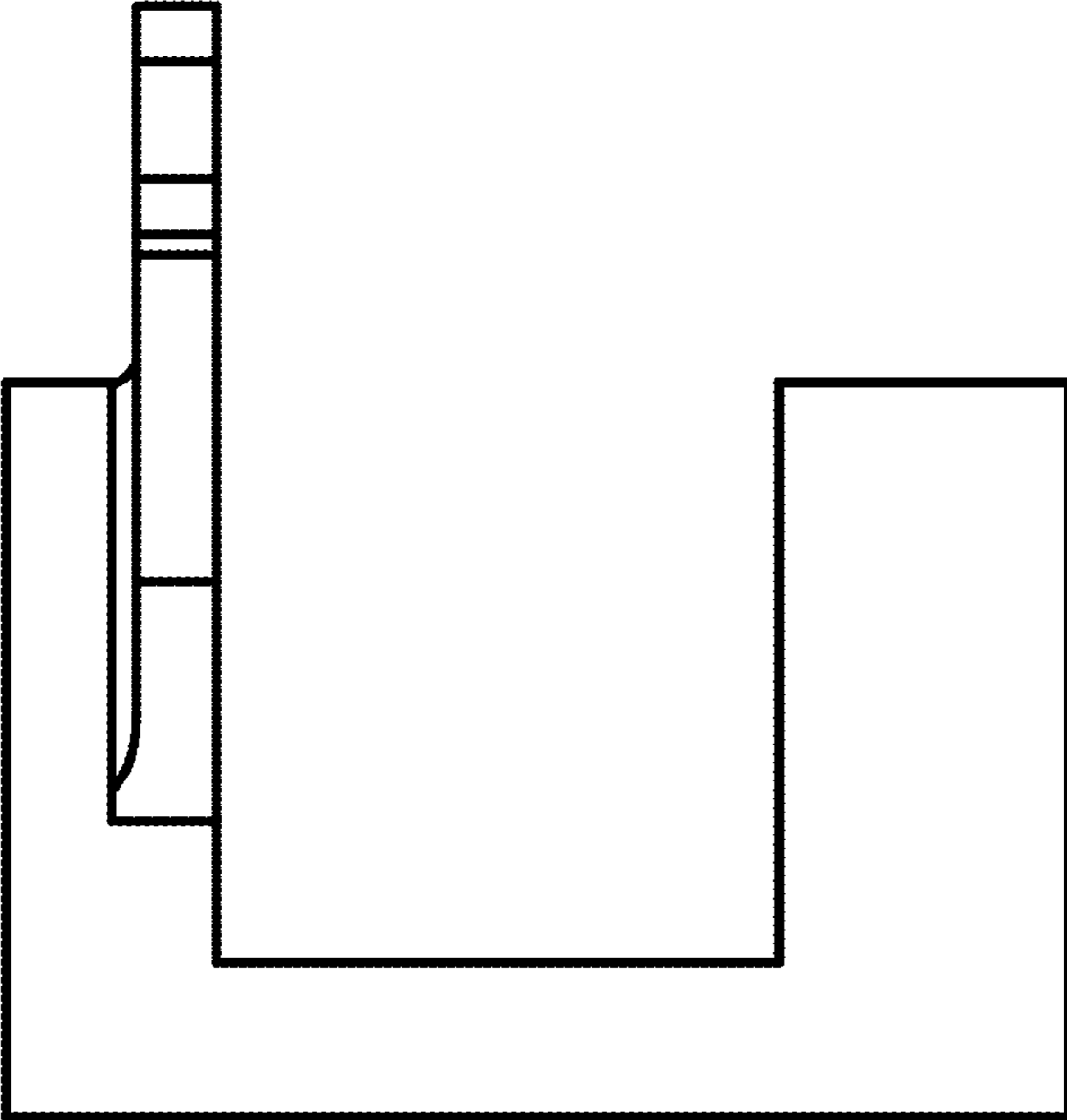

FIGURE 7