

US00D699961S

(12) **United States Design Patent**  
**Le et al.**

(10) **Patent No.:** **US D699,961 S**

(45) **Date of Patent:** **\*\* Feb. 25, 2014**

(54) **MASSAGE CHAIR**

(71) Applicants: **Kevin Le**, Richland Hills, TX (US);  
**Thanh Le**, Grand Prairie, TX (US)

(72) Inventors: **Kevin Le**, Richland Hills, TX (US);  
**Thanh Le**, Grand Prairie, TX (US)

(73) Assignee: **Luraco Technologies, Inc.**, Arlington,  
TX (US)

(\*\*) Term: **14 Years**

(21) Appl. No.: **29/450,167**

(22) Filed: **Mar. 15, 2013**

(51) **LOC (10) Cl.** ..... **06-01**

(52) **U.S. Cl.**  
USPC ..... **D6/367**

(58) **Field of Classification Search**  
USPC ..... D6/334–336, 360, 361, 367, 371, 373,  
D6/379, 375, 716, 716.1, 716.2, 716.3,  
D6/716.4, 717; 297/68, 271.1, 271.2,  
297/271.3, 353, 354.1, 411.45, 423.19,  
297/423.3; 601/90, 91, 97, 98, 99, 102,  
601/115, 116, 134, 148, 149

See application file for complete search history.

(56) **References Cited**

**U.S. PATENT DOCUMENTS**

D471,372 S \* 3/2003 Inada et al. .... D6/367  
D502,607 S \* 3/2005 Miyake et al. .... D6/335

D502,817 S \* 3/2005 Inada et al. .... D6/367  
D517,337 S \* 3/2006 Mori ..... D6/367  
D536,891 S \* 2/2007 Miyake et al. .... D6/367  
D580,671 S \* 11/2008 Aoki et al. .... D6/367  
D609,932 S \* 2/2010 Lee ..... D6/367  
D656,331 S \* 3/2012 Kita ..... D6/367  
D657,970 S \* 4/2012 Hwang et al. .... D6/367  
D680,766 S \* 4/2013 Morimoto et al. .... D6/367  
2010/0198120 A1 \* 8/2010 Tago et al. .... 601/134

\* cited by examiner

*Primary Examiner* — Mimoso De

(74) *Attorney, Agent, or Firm* — Hoang Steve Ngo

(57) **CLAIM**

The ornamental design for a massage chair, as shown and described.

**DESCRIPTION**

FIG. 1 is a front elevational view of a massage chair showing my new design;

FIG. 2 is a rear elevational view thereof;

FIG. 3 is a right side elevational view thereof;

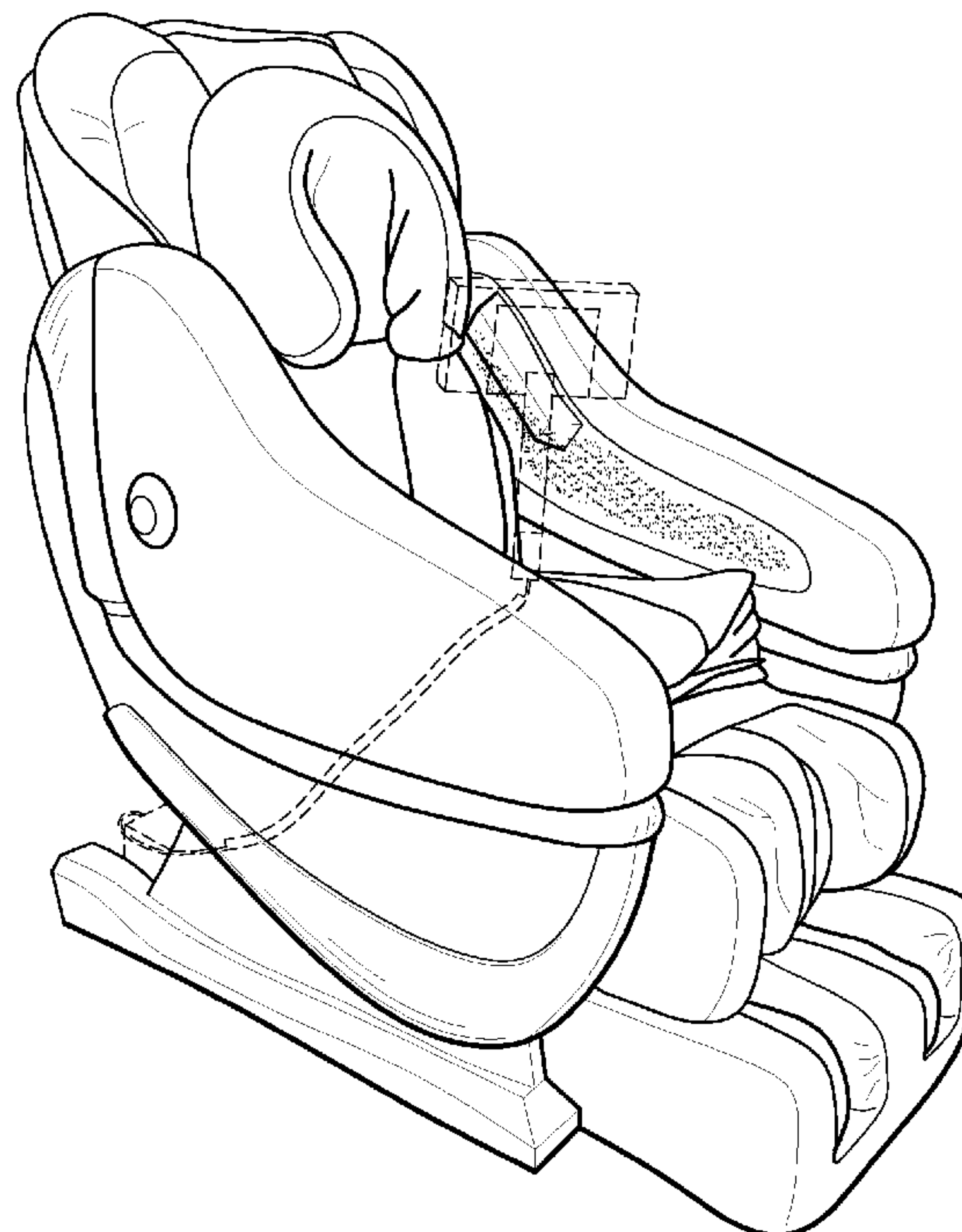
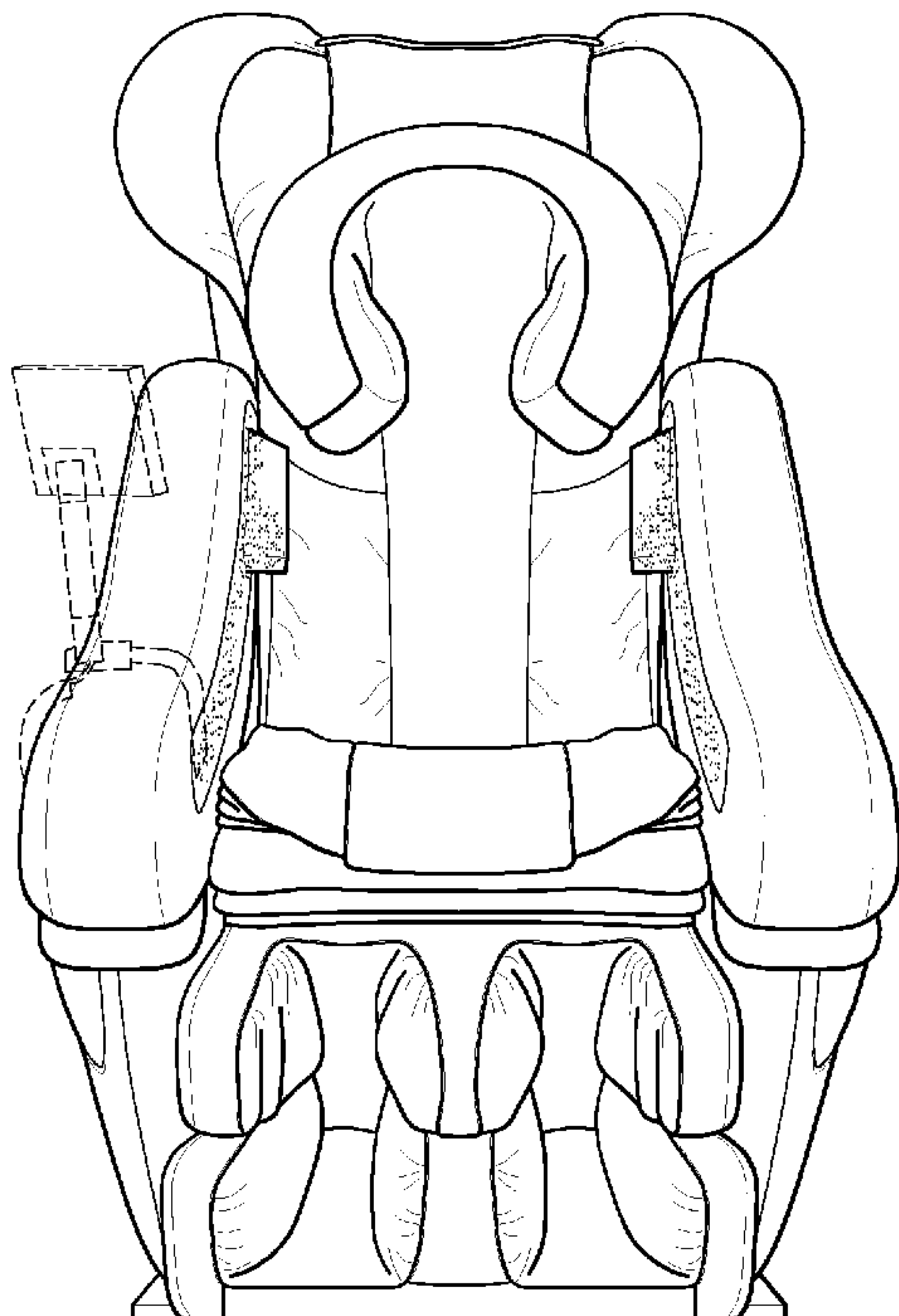
FIG. 4 is a left side elevational view thereof;

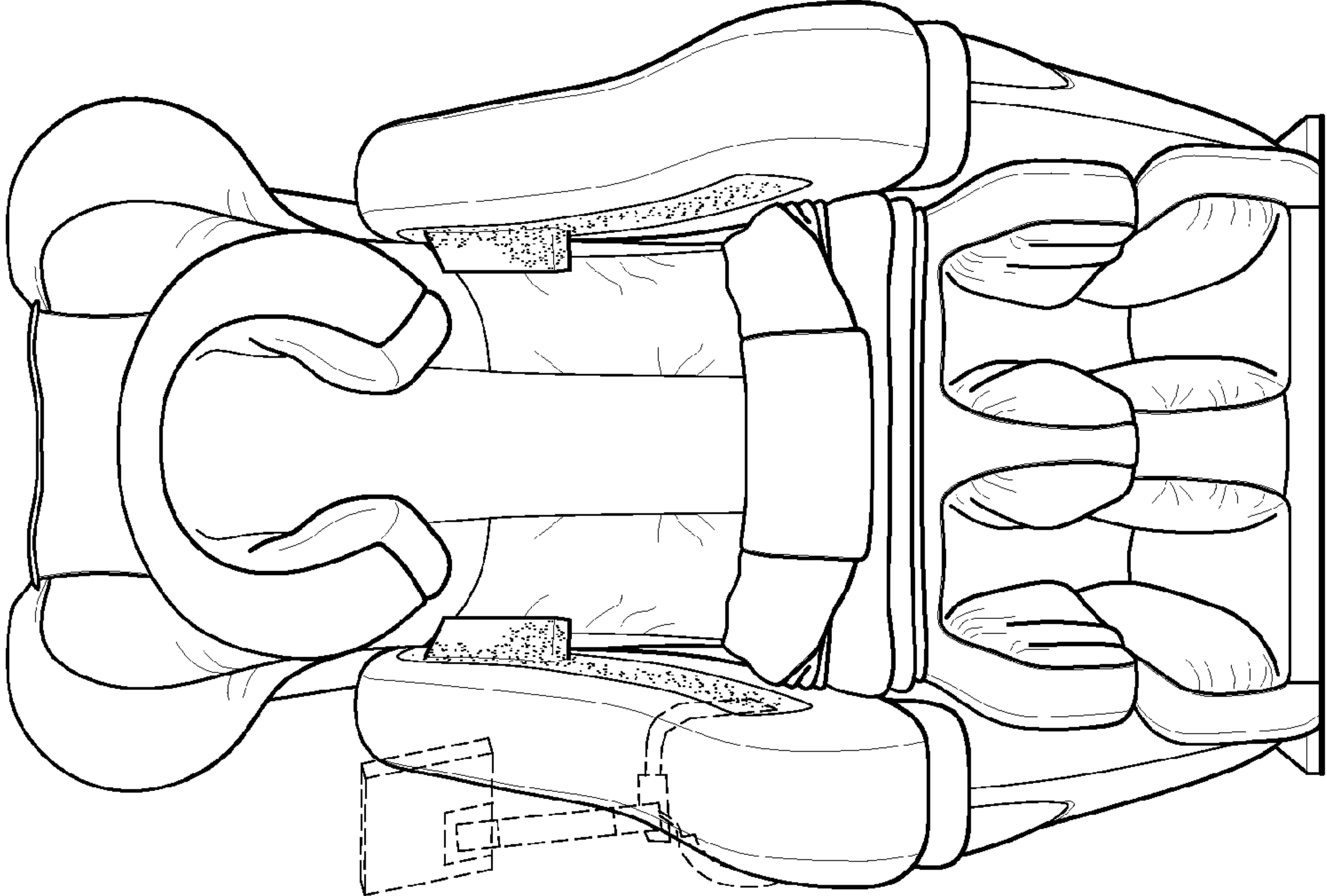
FIG. 5 is a front, right side perspective view thereof; and,

FIG. 6 is a front, left side perspective view thereof.

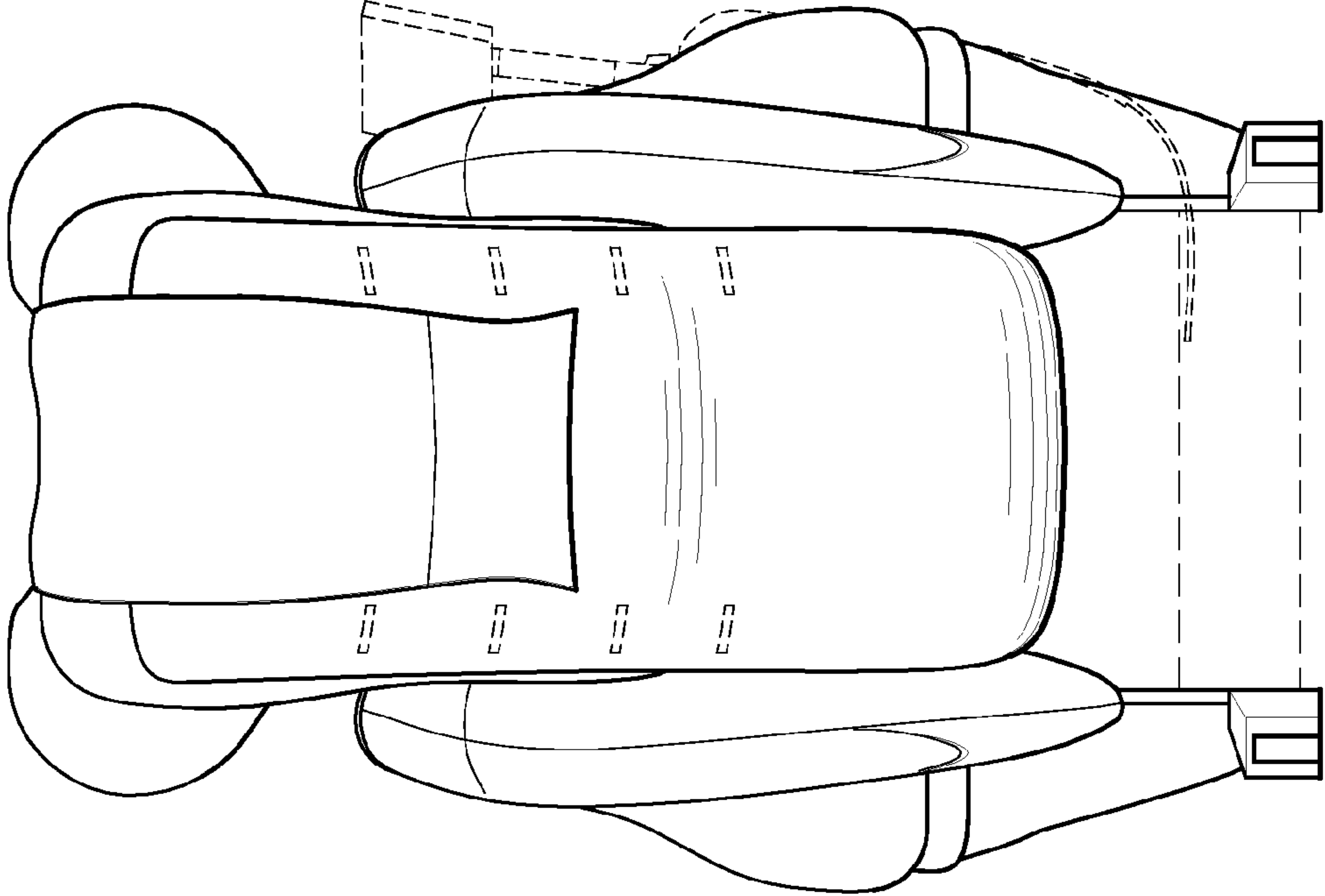
The broken lines shown in the drawing views are included for illustrative purposes only, and form no part of the claimed design.

**1 Claim, 6 Drawing Sheets**

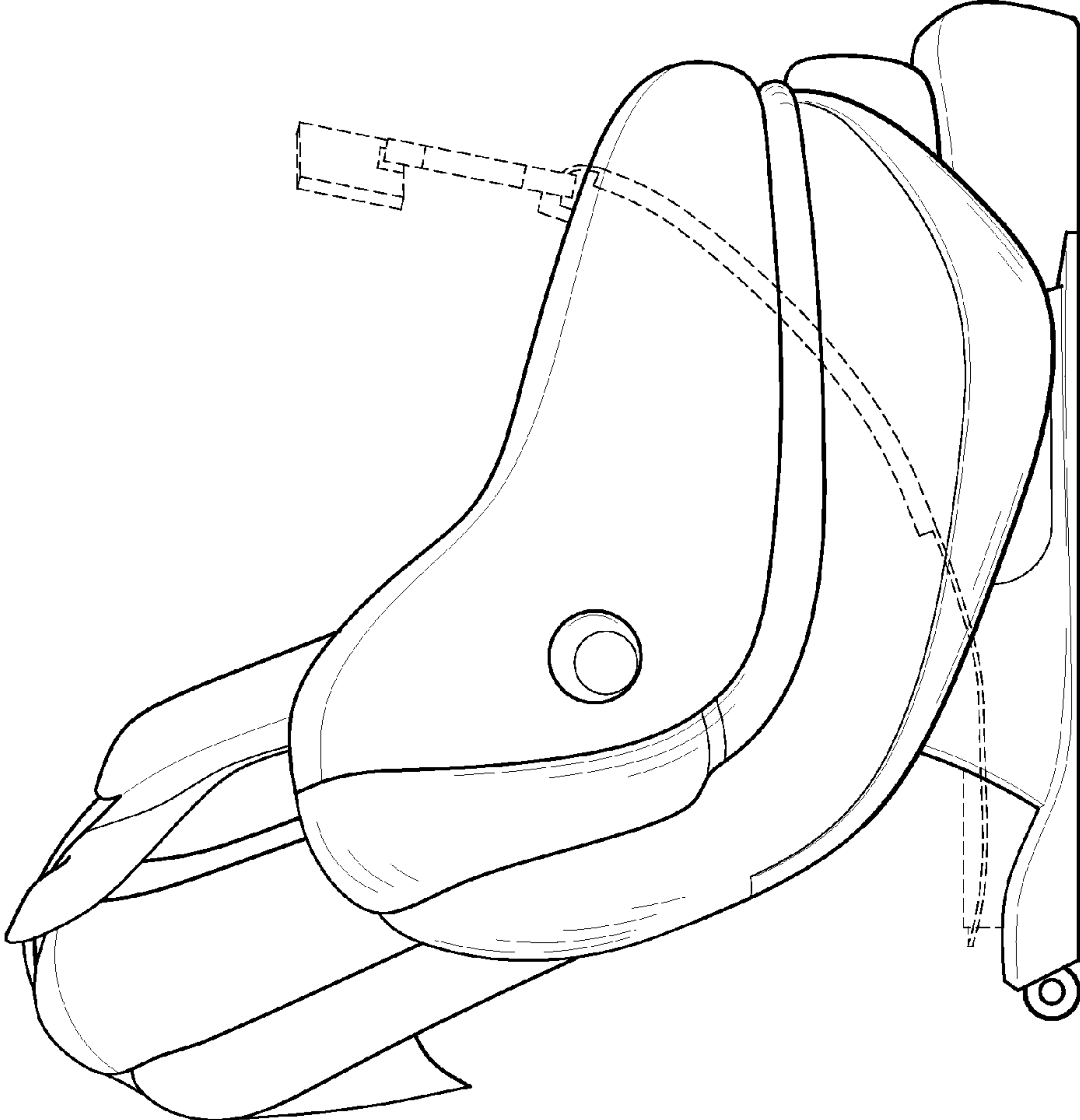




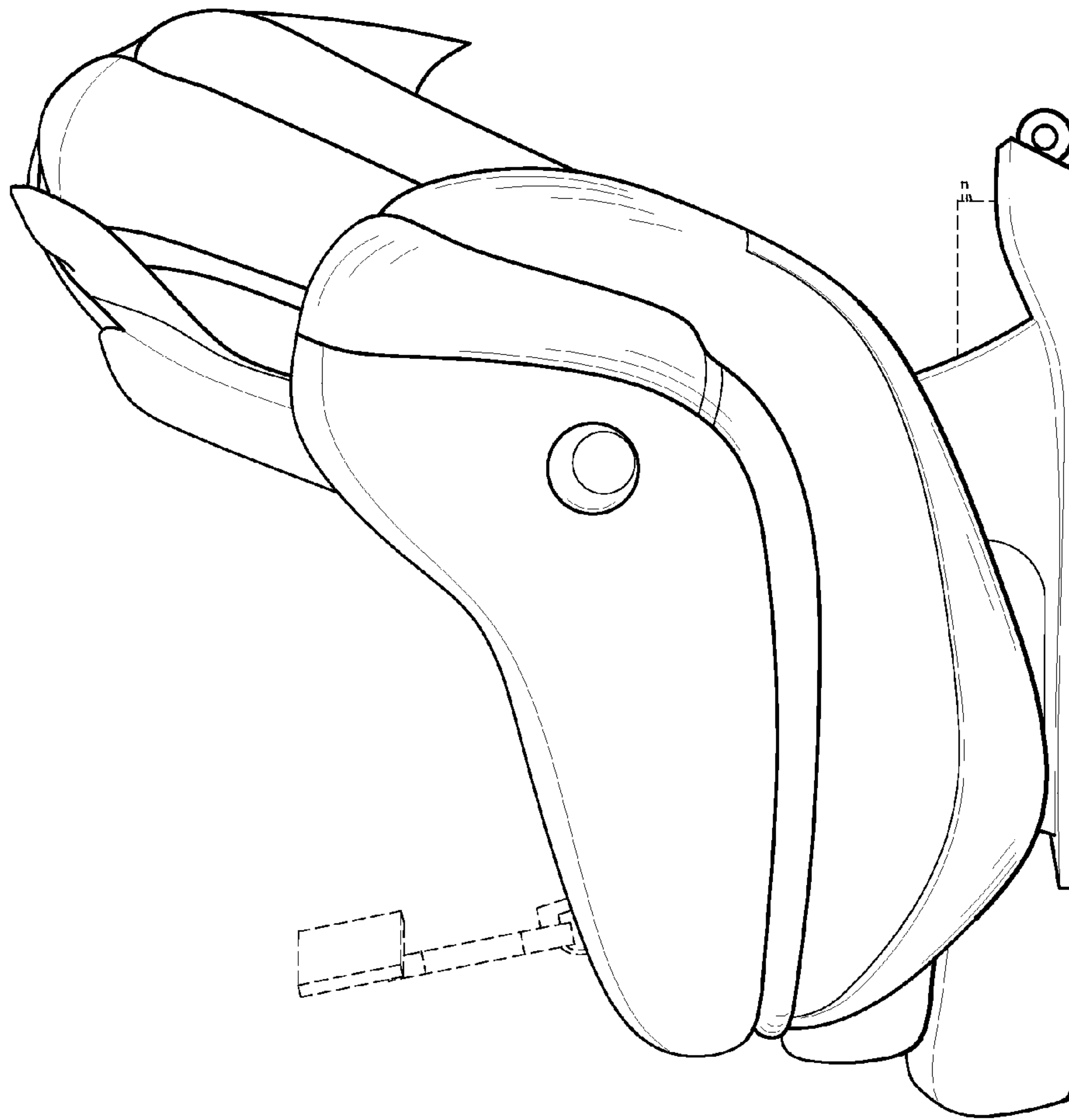
**FIG. 1**



**FIG. 2**

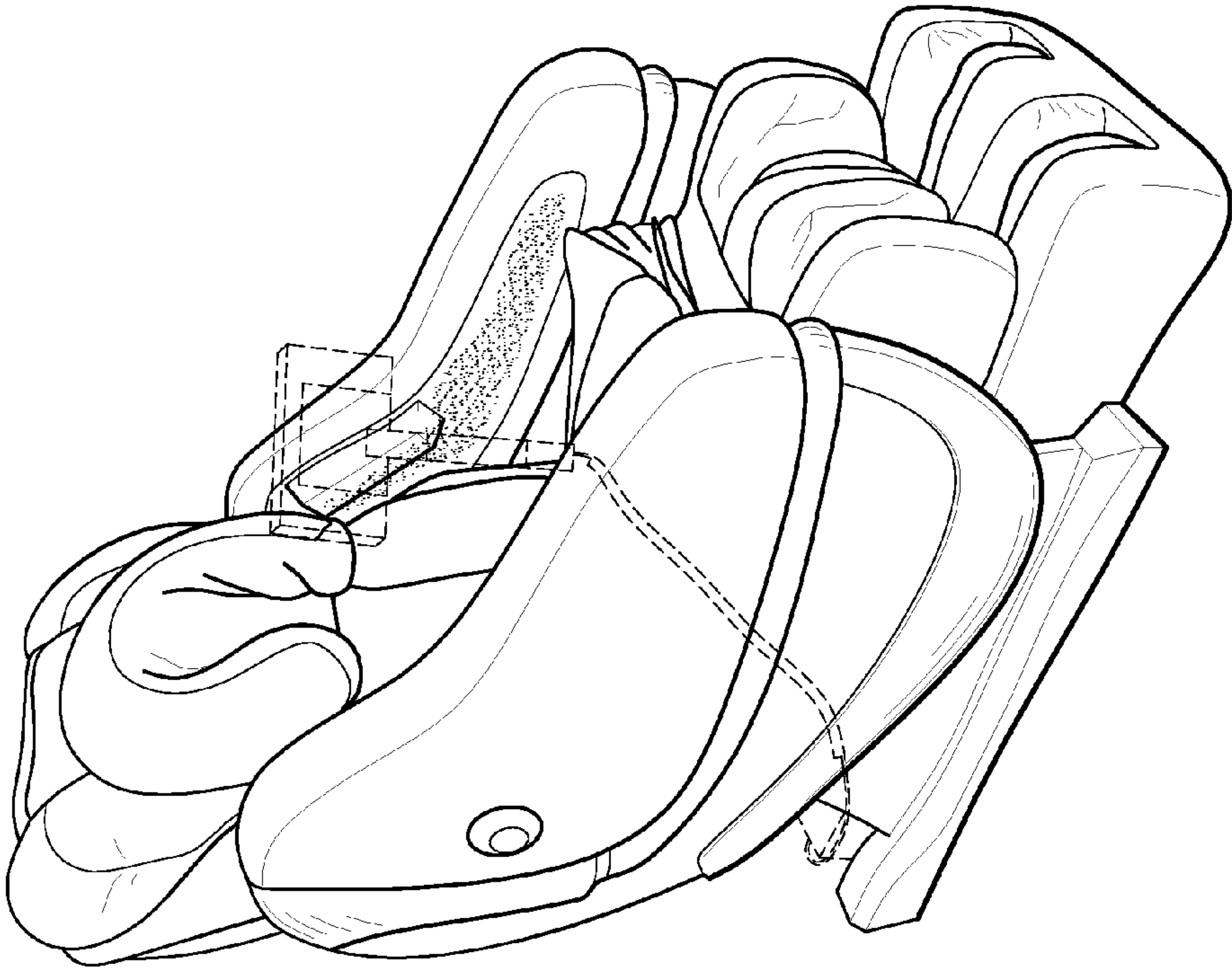


**FIG. 3**

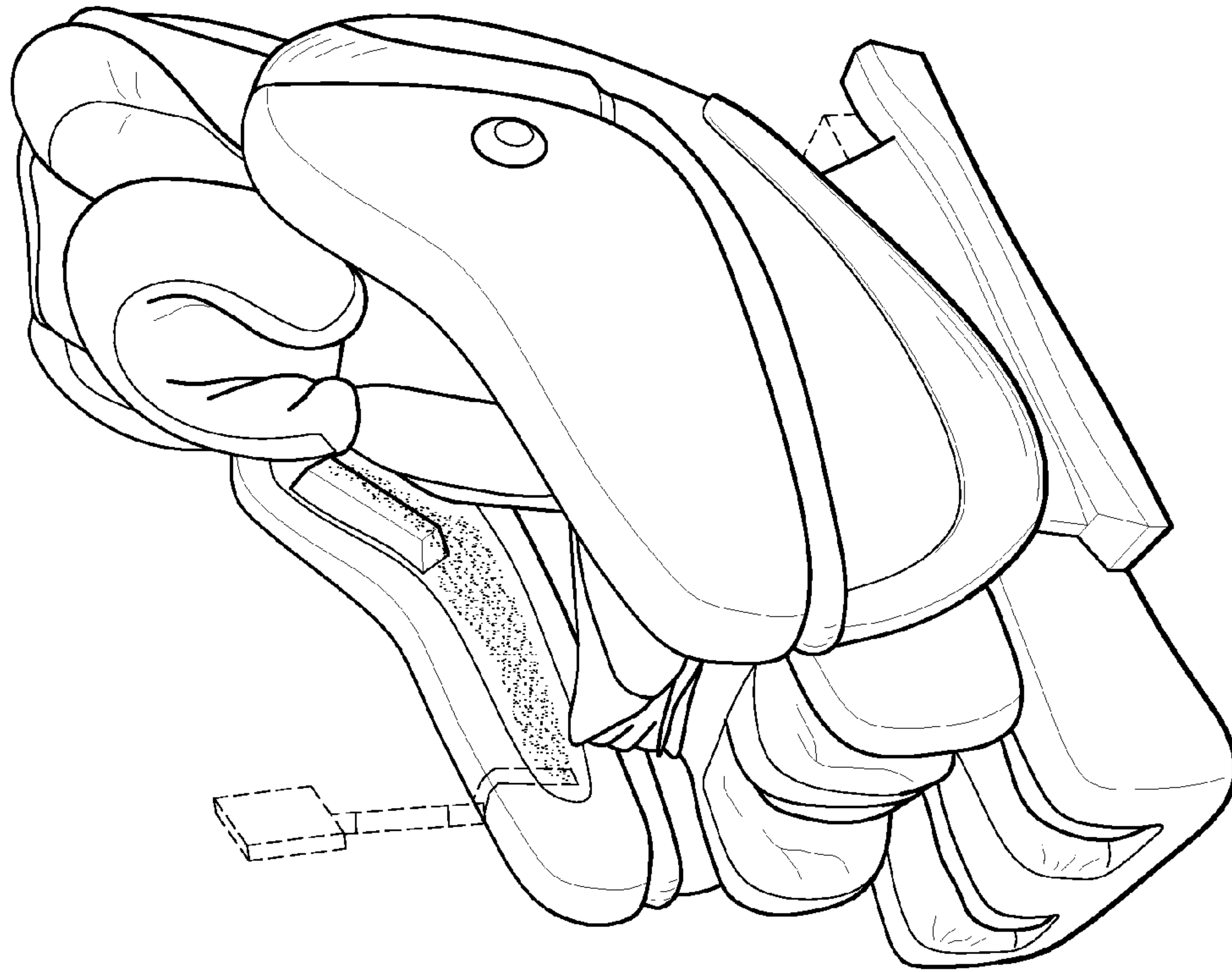


**FIG. 4**





**FIG. 5**



**FIG. 6**