



US00D699909S

(12) **United States Design Patent**
Vasilakes et al.

(10) **Patent No.:** **US D699,909 S**

(45) **Date of Patent:** **** Feb. 18, 2014**

(54) **CLEANING TOOL**

D674,197 S * 1/2013 Kassem Llano et al. D4/199
D685,547 S * 7/2013 Vasilakes et al. D32/40

(75) Inventors: **Lloyd S. Vasilakes**, Stillwater, MN (US);
Qian Zheng Zhou, Shanghai (CN);
Giuseppe De Bellis, Milanese (IT);
Valentina Tronconi, Milan (IT); **Monica Jerez**, Woodbury, MN (US); **Adel M. Kassem Llano**, Milan (IT)

* cited by examiner

Primary Examiner — John Windmuller
(74) *Attorney, Agent, or Firm* — Irina Hass

(73) Assignee: **3M Innovative Properties Company**,
St. Paul, MN (US)

(57) **CLAIM**

The ornamental design for a cleaning tool, as shown and described.

(**) Term: **14 Years**

DESCRIPTION

(21) Appl. No.: **29/425,730**

FIG. 1 is a perspective view of a first embodiment of a cleaning tool showing the new design;

(22) Filed: **Jun. 26, 2012**

FIG. 2 is a right side view thereof, the left side view being a mirror image thereof;

(51) **LOC (10) Cl.** **04-01**

FIG. 3 is a front view thereof;

(52) **U.S. Cl.**
USPC **D32/50; D32/51; D4/118**

FIG. 4 is a bottom view thereof;

(58) **Field of Classification Search**
USPC D32/47, 40; 15/159.1, 160, 161, 110,
15/112, 237; D4/118, 119, 120, 130;
D6/583, 592, 594

FIG. 5 is a top view thereof;

See application file for complete search history.

FIG. 6 is a rear view thereof;

FIG. 7 is a perspective view thereof showing the cleaning tool with a long handle;

FIG. 8 is a perspective view of a second embodiment of a cleaning tool showing the new design;

FIG. 9 is a right side view thereof, the left side view being a mirror image thereof;

(56) **References Cited**

U.S. PATENT DOCUMENTS

1,922,998	A *	8/1933	Williams	15/111
D232,299	S *	8/1974	Epstein	D4/118
D278,099	S *	3/1985	Evans	D4/116
D315,975	S *	4/1991	Huang	D32/41
D351,948	S *	11/1994	Getchell	D4/132
D355,075	S *	2/1995	Stone	D4/118
D378,322	S *	3/1997	Young	D4/118
D444,952	S *	7/2001	Mason, Jr.	D4/118
D509,964	S *	9/2005	Berti	D4/199
D617,158	S *	6/2010	Smith	D8/10
D656,735	S *	4/2012	Zupan	D4/116

FIG. 10 is a front view thereof;

FIG. 11 is a bottom view thereof;

FIG. 12 is a top view thereof;

FIG. 13 is a rear view thereof; and,

FIG. 14 is a perspective view thereof showing the cleaning tool with a long handle.

The broken lines in the drawings are shown for illustrative purposes only and form no part of the claimed design. In addition, the surface shading illustrated in the drawings is provided merely to highlight the contour of design; it is not intended to be illustrative of texture or gloss.

1 Claim, 8 Drawing Sheets

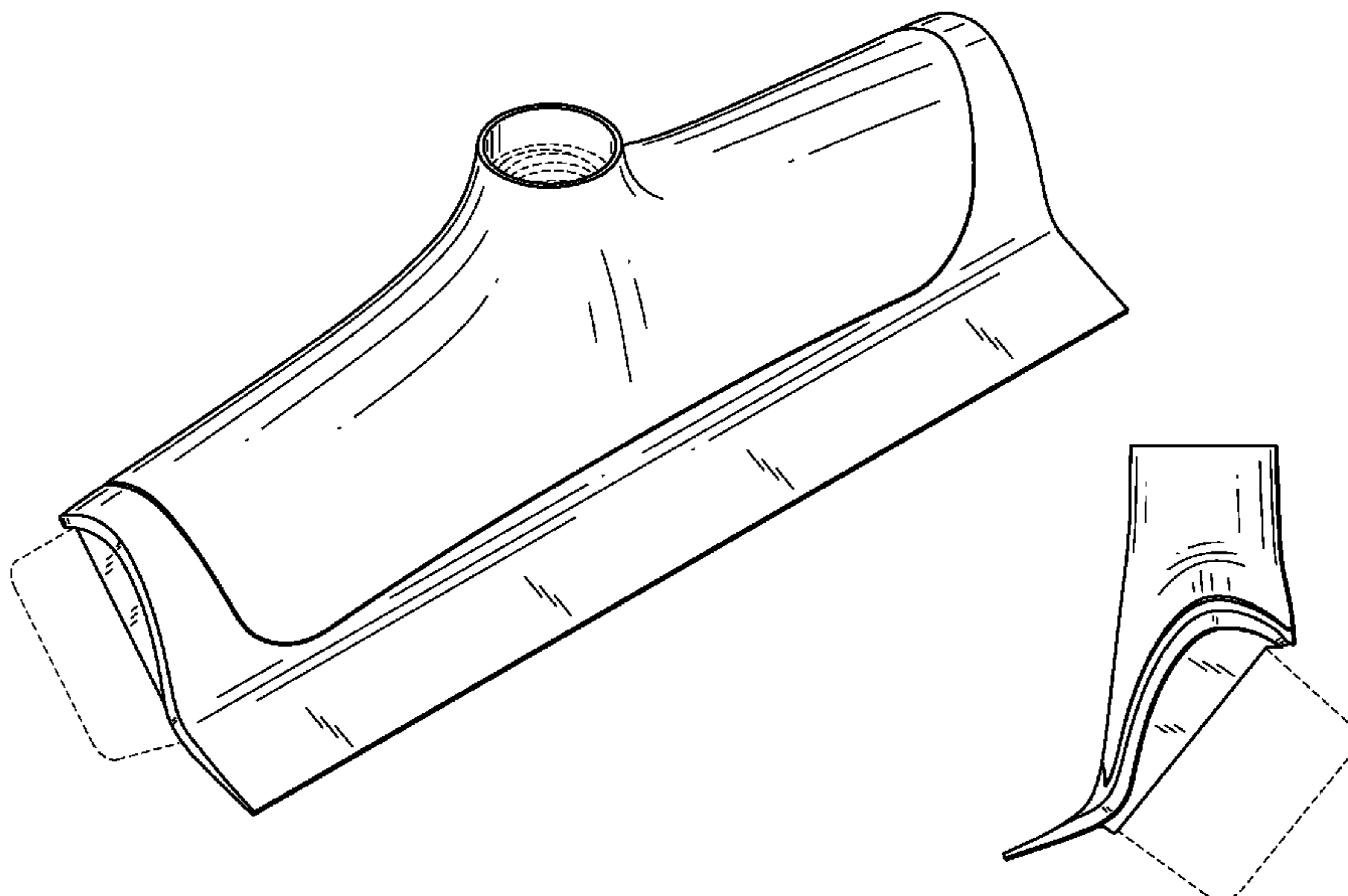

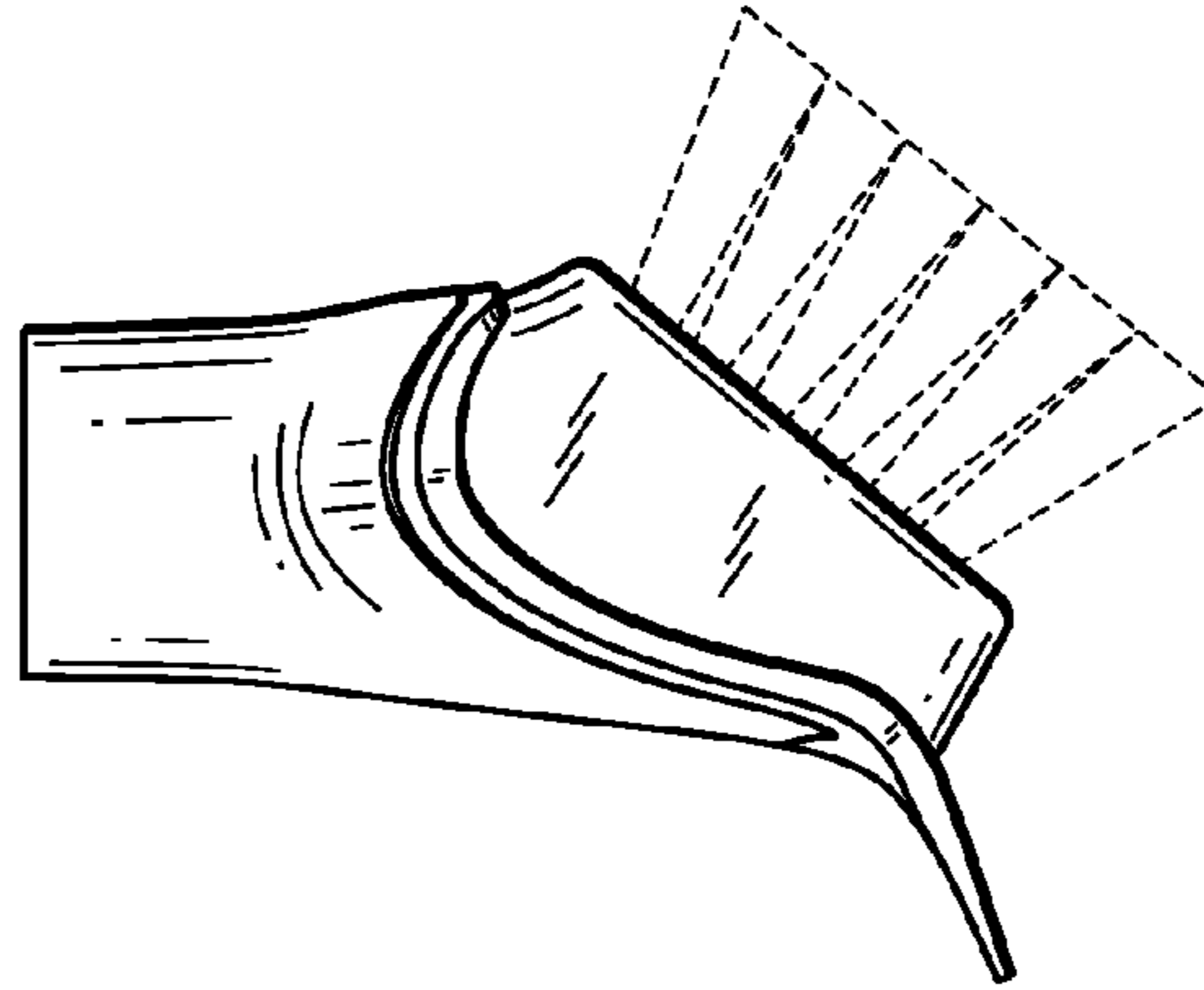
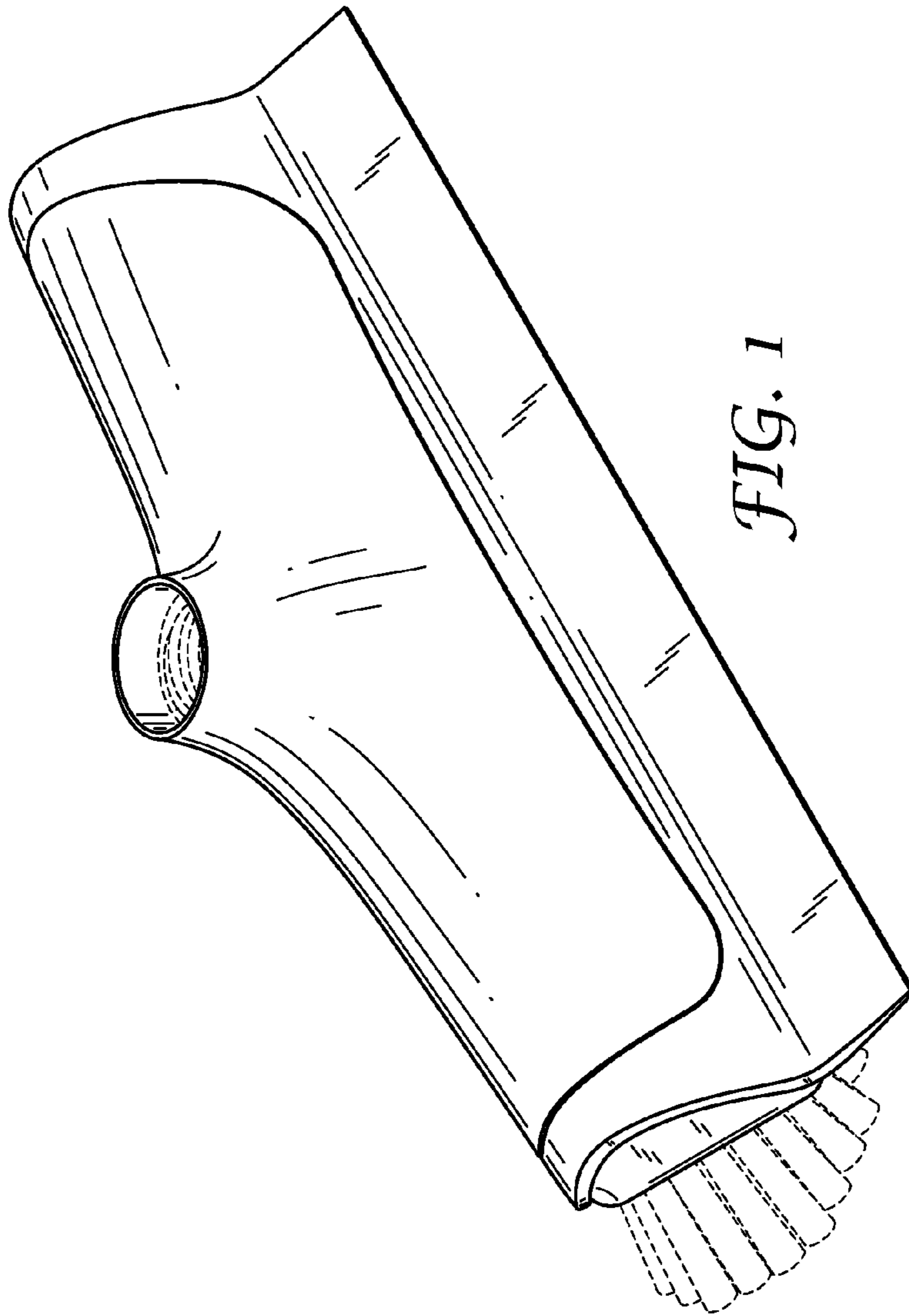

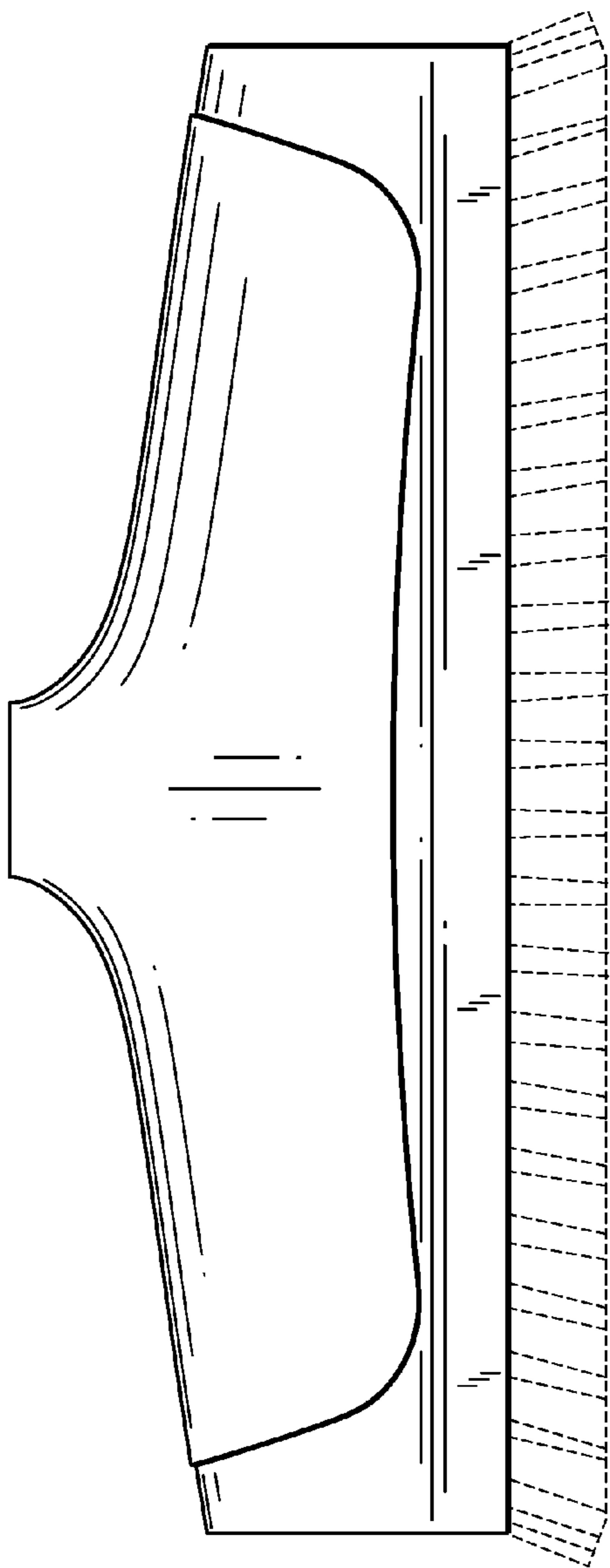

FIG. 3

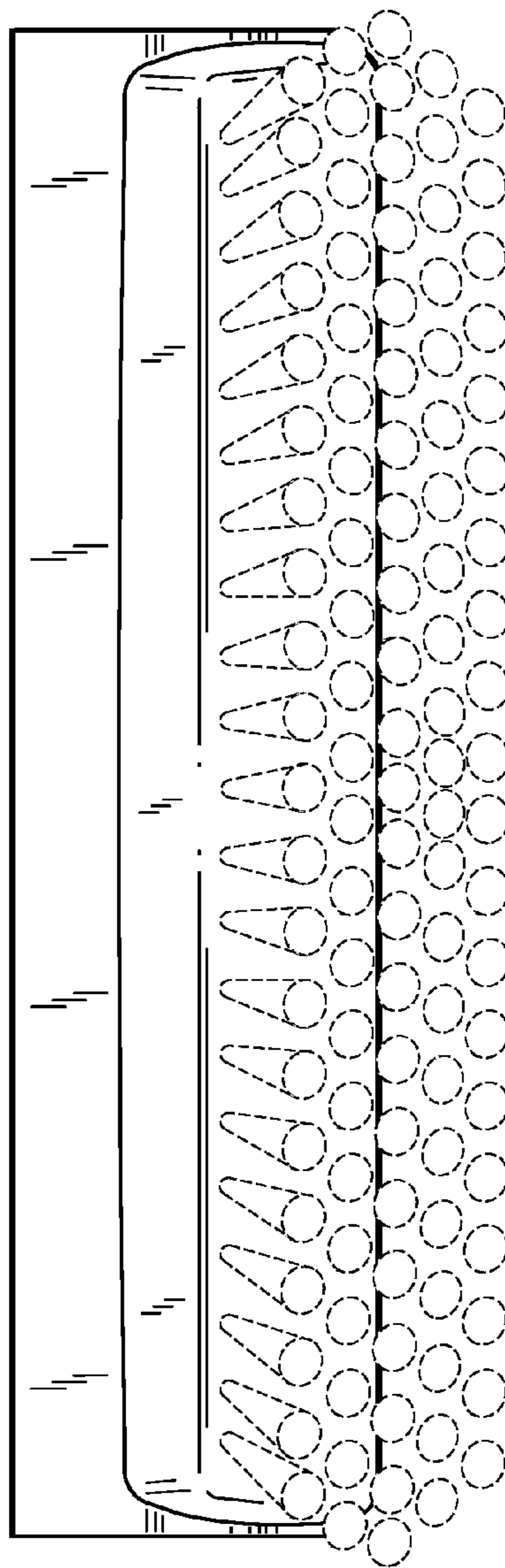

FIG. 4

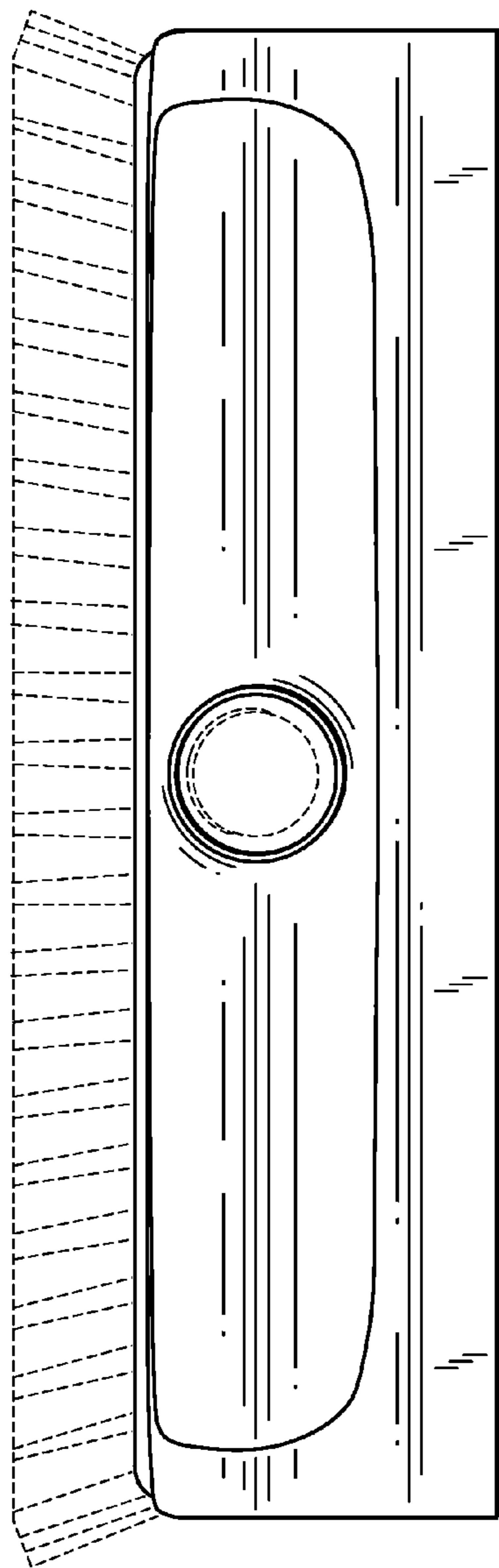

FIG. 5

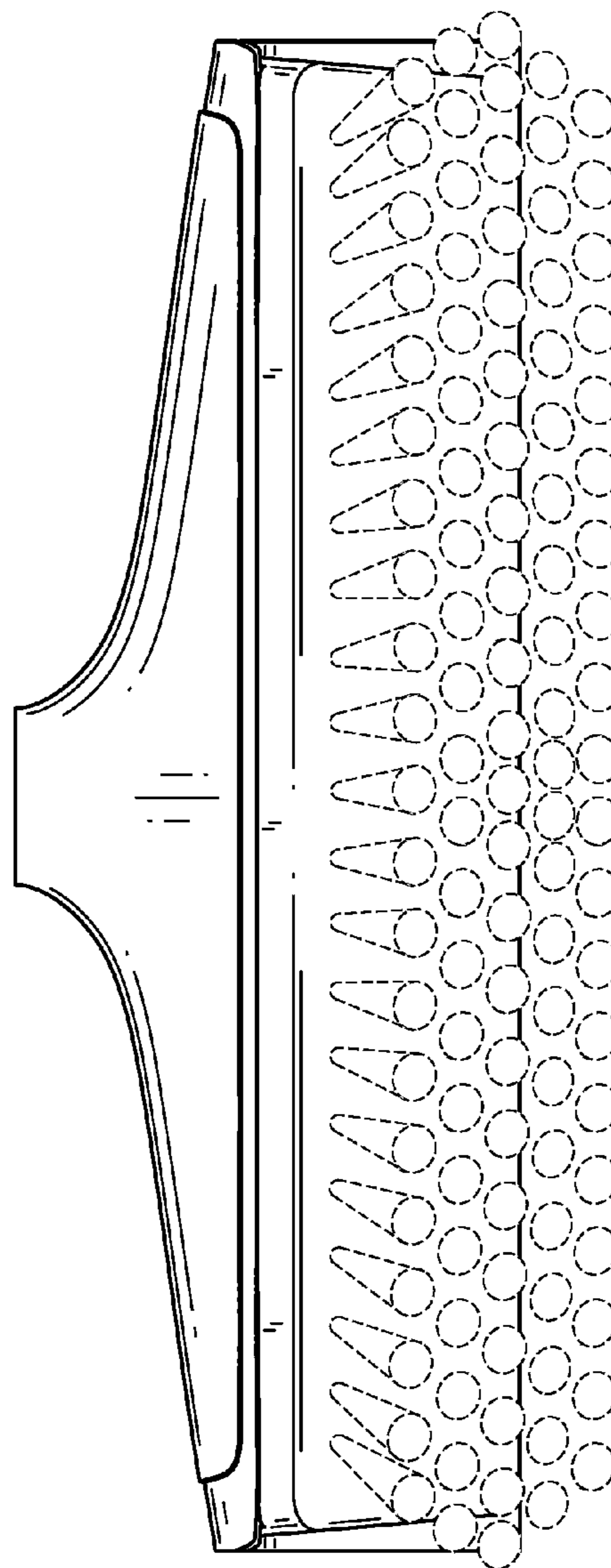

FIG. 6

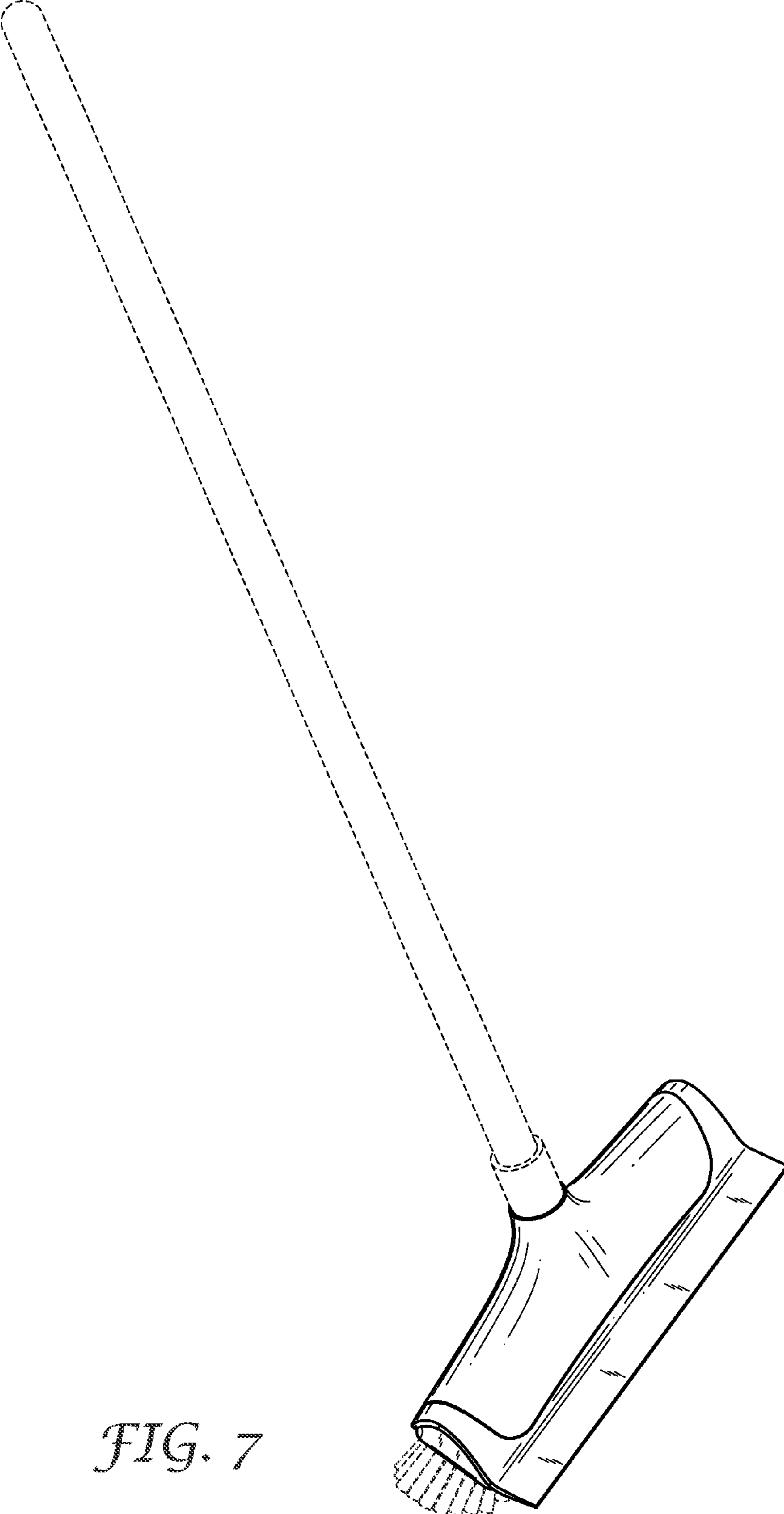

FIG. 7

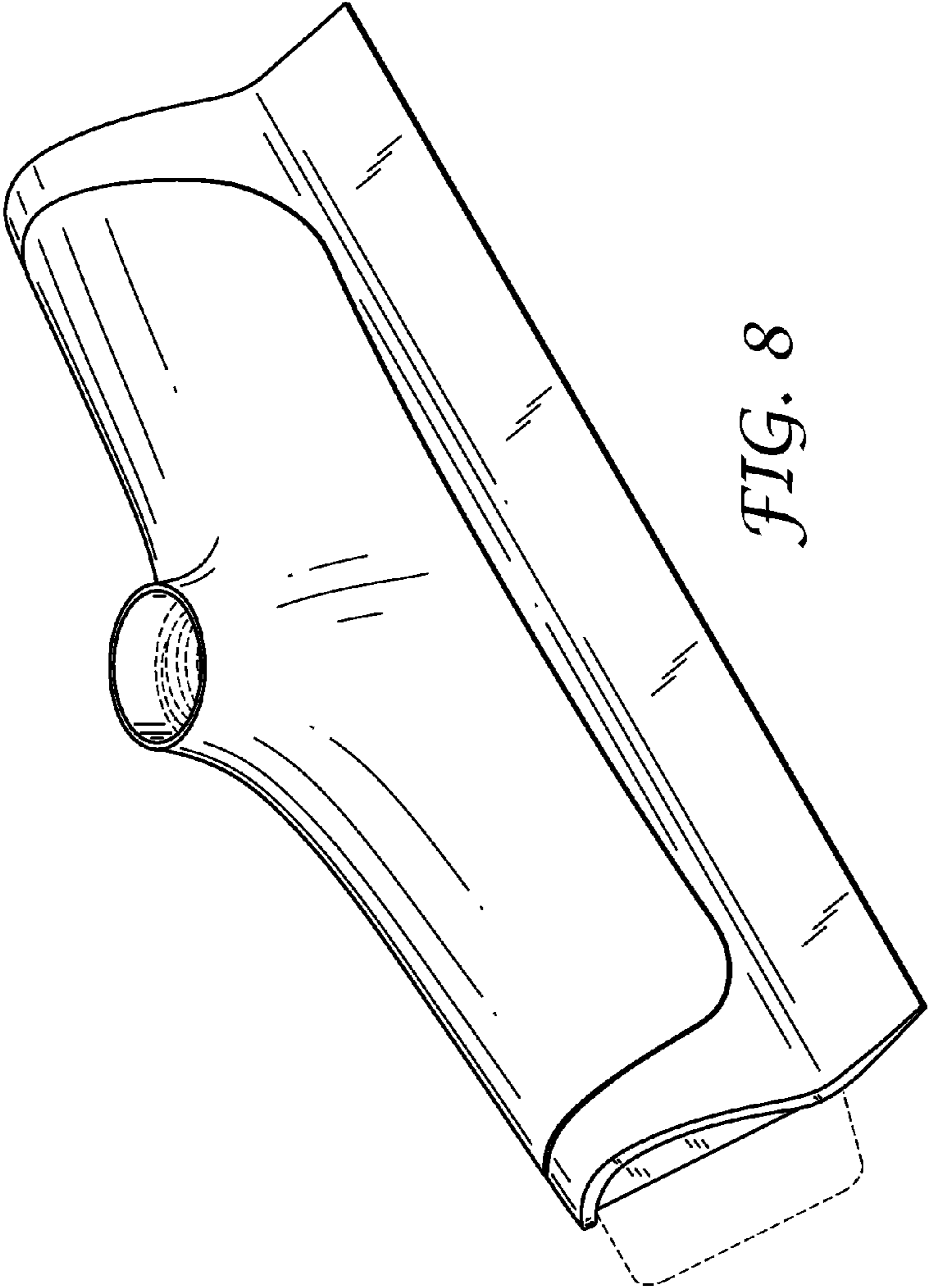

FIG. 8

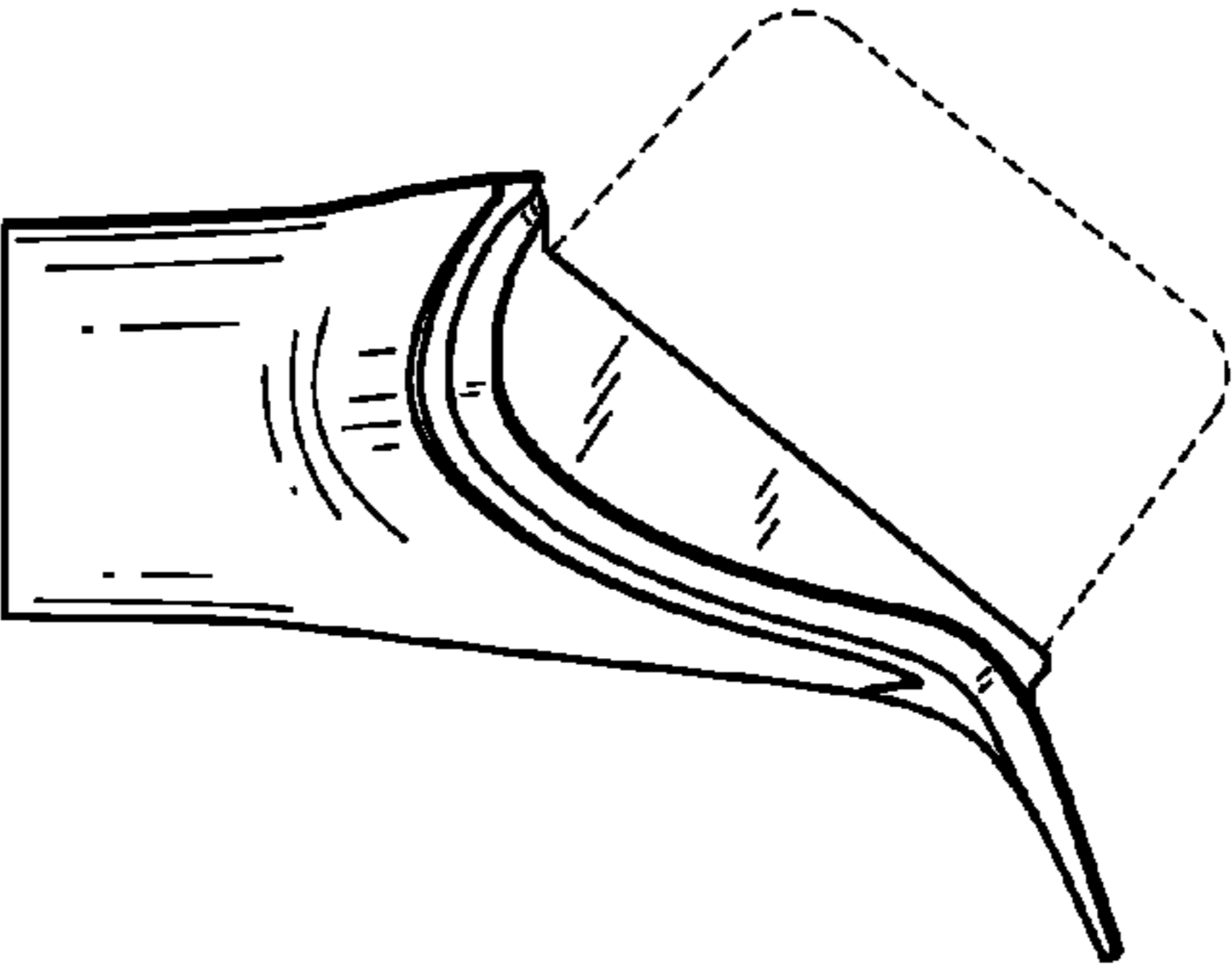

FIG. 9

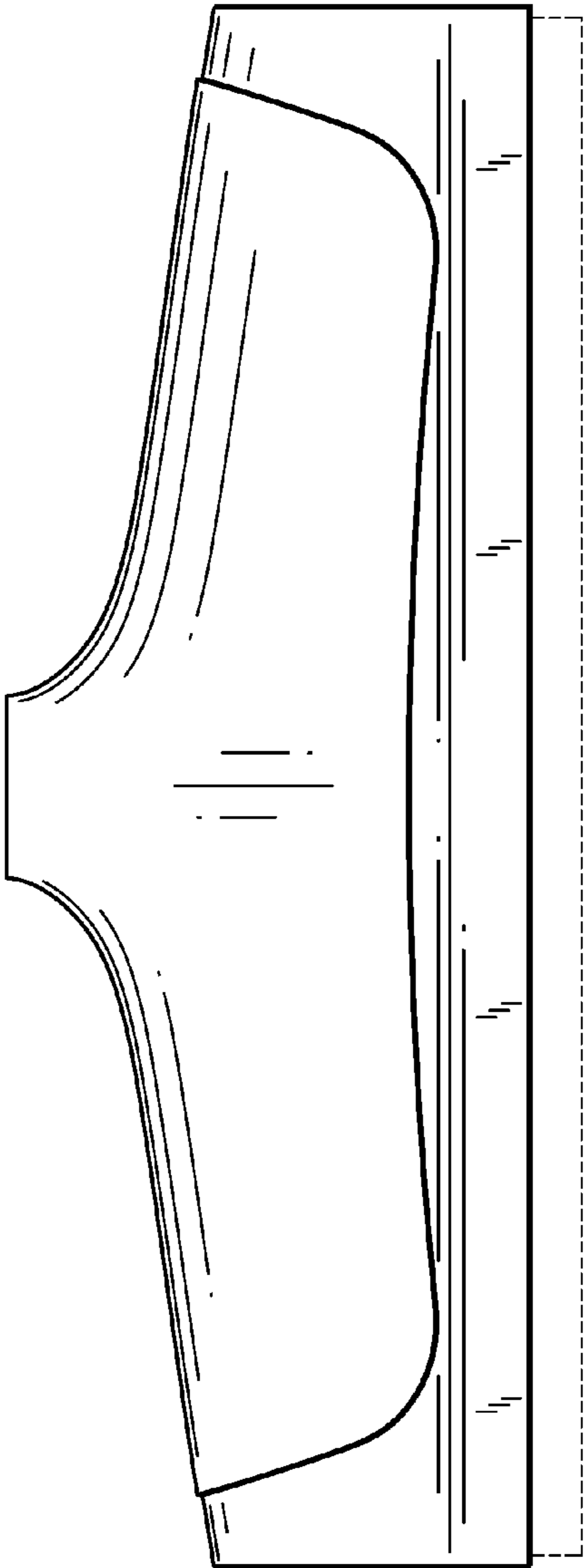

FIG. 10

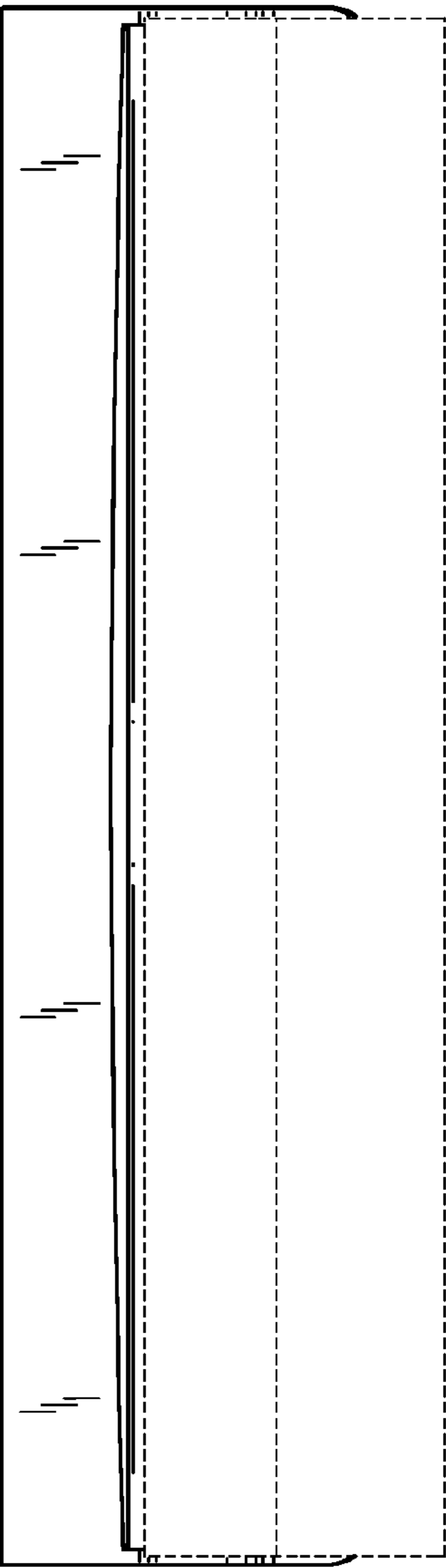

FIG. 11

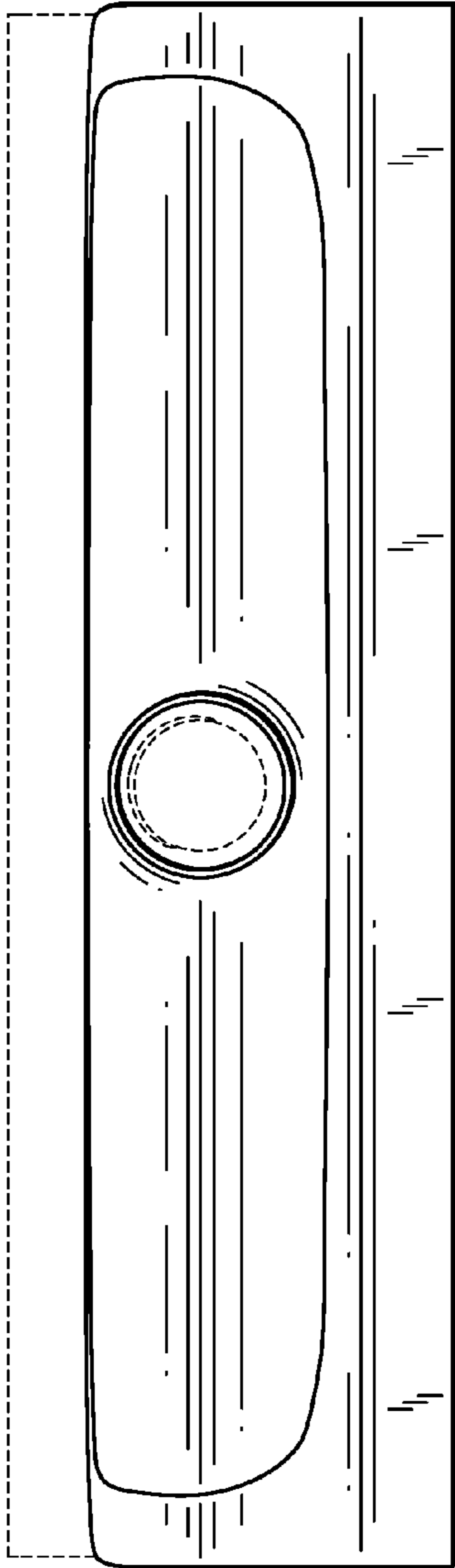

FIG. 12

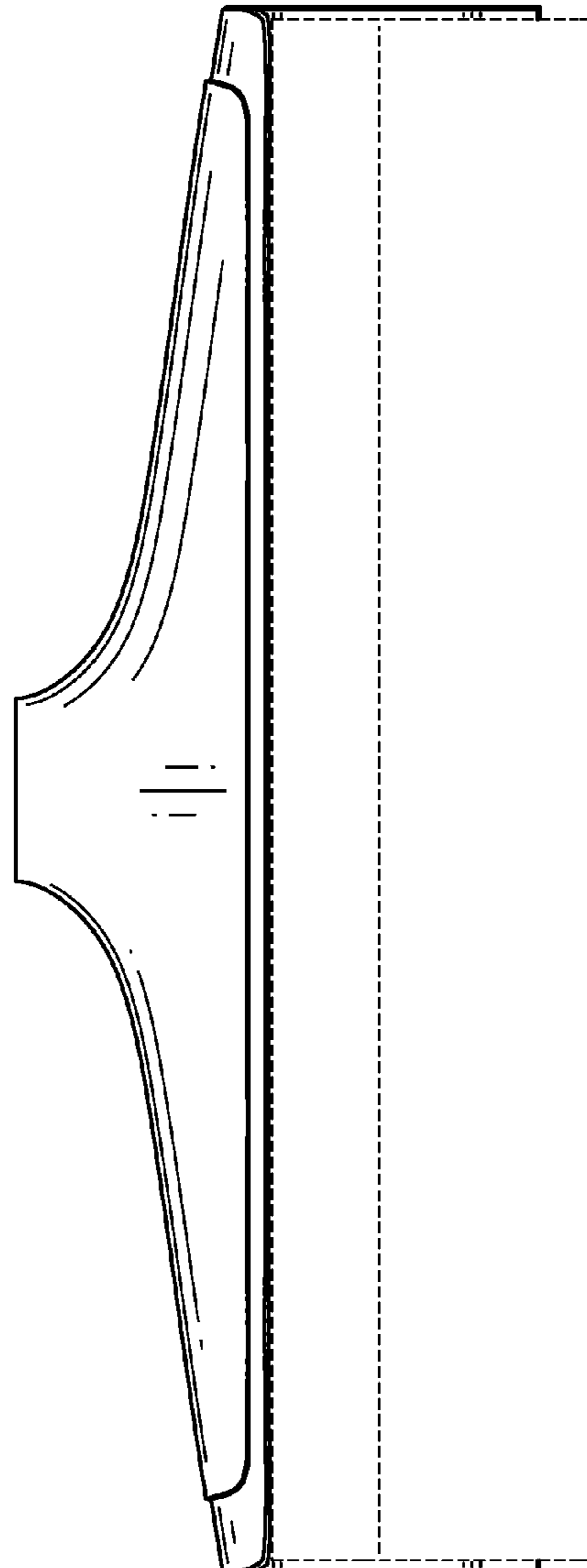

FIG. 13

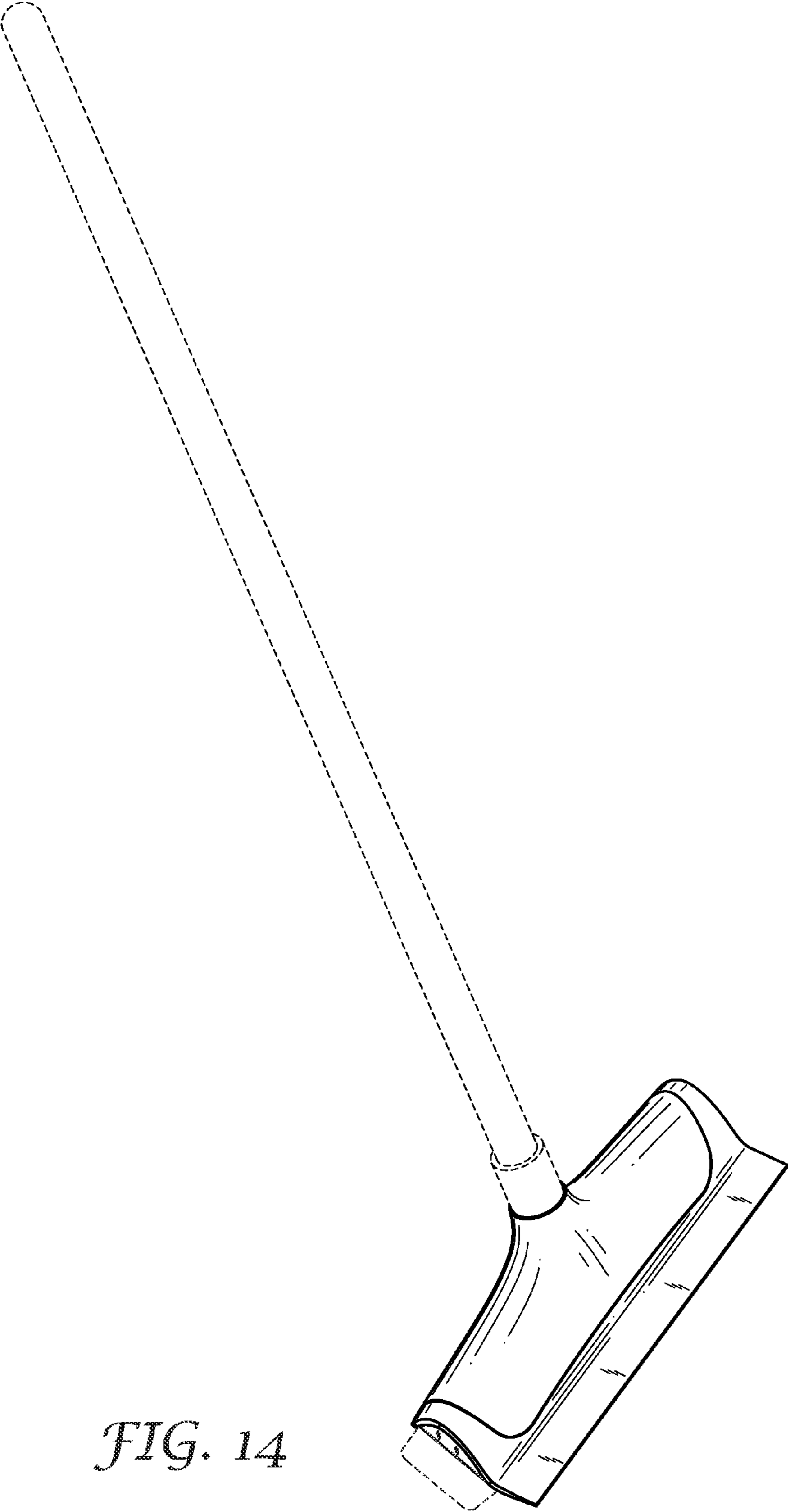

FIG. 14