

US00D699839S

(12) **United States Design Patent**
Voic

(10) **Patent No.:** **US D699,839 S**

(45) **Date of Patent:** **** Feb. 18, 2014**

(54) **SURGICAL SHIELD**

(75) Inventor: **Dan Voic**, Cedar Grove, NJ (US)

(73) Assignee: **Misonix, Incorporated**, Farmingdale, NY (US)

(**) Term: **14 Years**

(21) Appl. No.: **29/404,754**

(22) Filed: **Oct. 25, 2011**

(51) **LOC (10) Cl.** **24-02**

(52) **U.S. Cl.**
USPC **D24/127**

(58) **Field of Classification Search**
USPC D24/127-131, 112-114, 133, 186, 118,
D24/122; 606/181, 185; 604/264, 272, 115,
604/232, 187, 158, 164.08, 192, 263, 163,
604/181, 184, 198, 227, 337-339, 342,
604/344; 600/101, 139, 143; 128/846, 887,
128/888, 890, 200.24, 207.14, 207.15,
128/207.16, DIG. 26, DIG. 6; D23/259-262,
D23/269, 254; D8/350, 352; 285/86, 46,
285/405; D9/454; D7/398, 900
See application file for complete search history.

(56) **References Cited**

U.S. PATENT DOCUMENTS

3,495,592 A * 2/1970 Shepard 604/336
D262,658 S * 1/1982 Christine D24/118
4,338,937 A * 7/1982 Lerman 128/887
D303,932 S * 10/1989 Pasillas D9/454

5,312,378 A * 5/1994 Jain 604/307
D385,956 S * 11/1997 Doughty et al. D23/259
6,869,422 B2 * 3/2005 Fenton 604/338
D552,719 S * 10/2007 Petner et al. D23/261
7,429,687 B2 * 9/2008 Kauth et al. 128/888
7,748,385 B2 * 7/2010 Lieberman et al. 128/207.16
D678,752 S * 3/2013 Sedwick D8/352
8,449,513 B2 * 5/2013 Abrams 604/342
8,523,897 B2 * 9/2013 van der Burg et al. 128/887

* cited by examiner

Primary Examiner — David Muller

(74) *Attorney, Agent, or Firm* — R. Neil Sudol; Coleman Sudol Sapone, P.C.

(57) **CLAIM**

The ornamental design for the surgical shield, as shown and described.

DESCRIPTION

FIG. 1 is a top, front, and left side perspective view of a surgical shield, showing my new design;
FIG. 2 is a top plan view thereof;
FIG. 3 is a bottom plan view thereof;
FIG. 4 is a front elevational view thereof;
FIG. 5 is a rear elevational view thereof;
FIG. 6 is a left side elevational view thereof; and,
FIG. 7 is a right side elevational view thereof.
The broken line showing of parts of the drawings is included for the purpose of illustrating use and environment and forms no part of the claimed design.

1 Claim, 4 Drawing Sheets

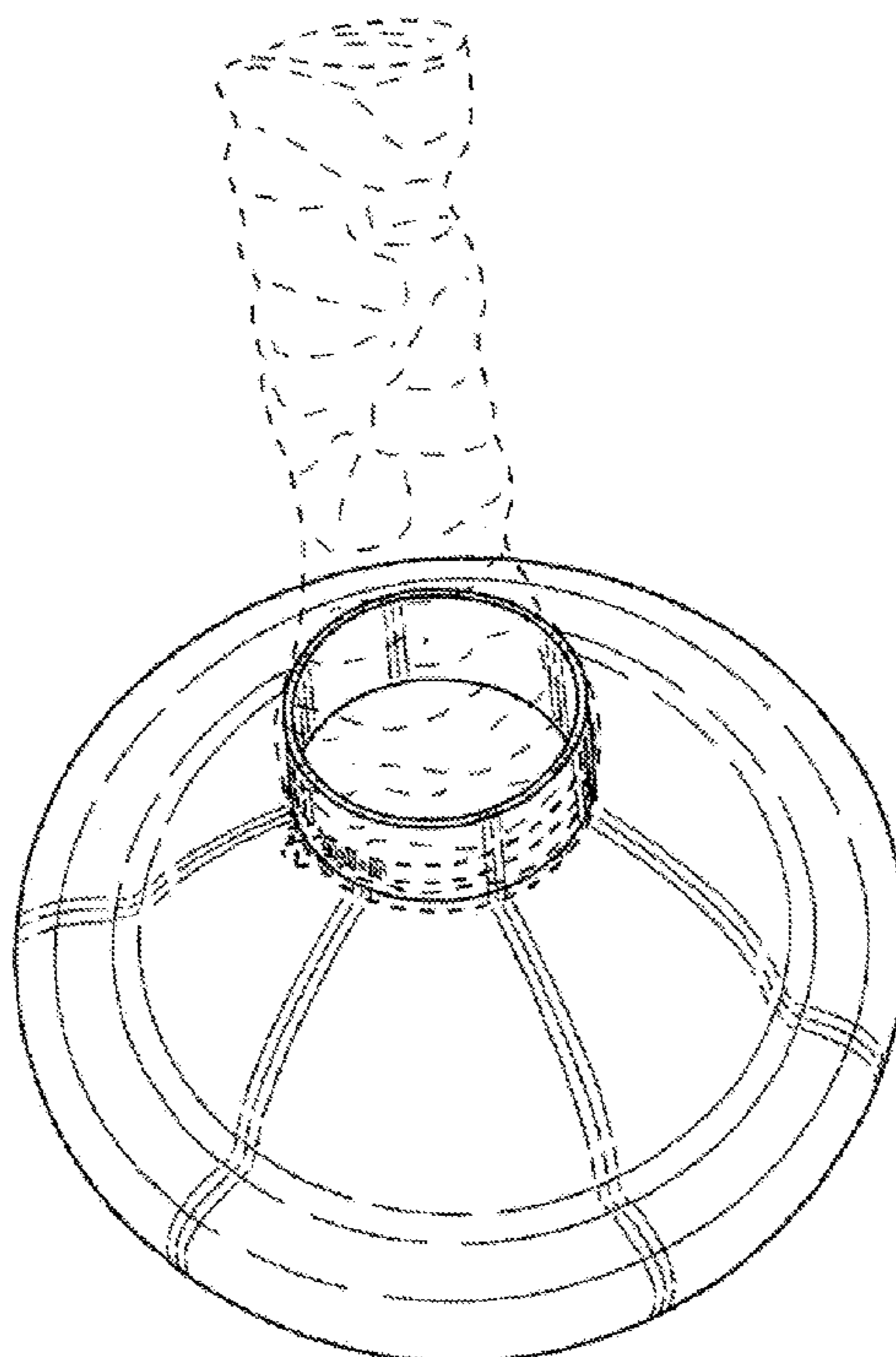

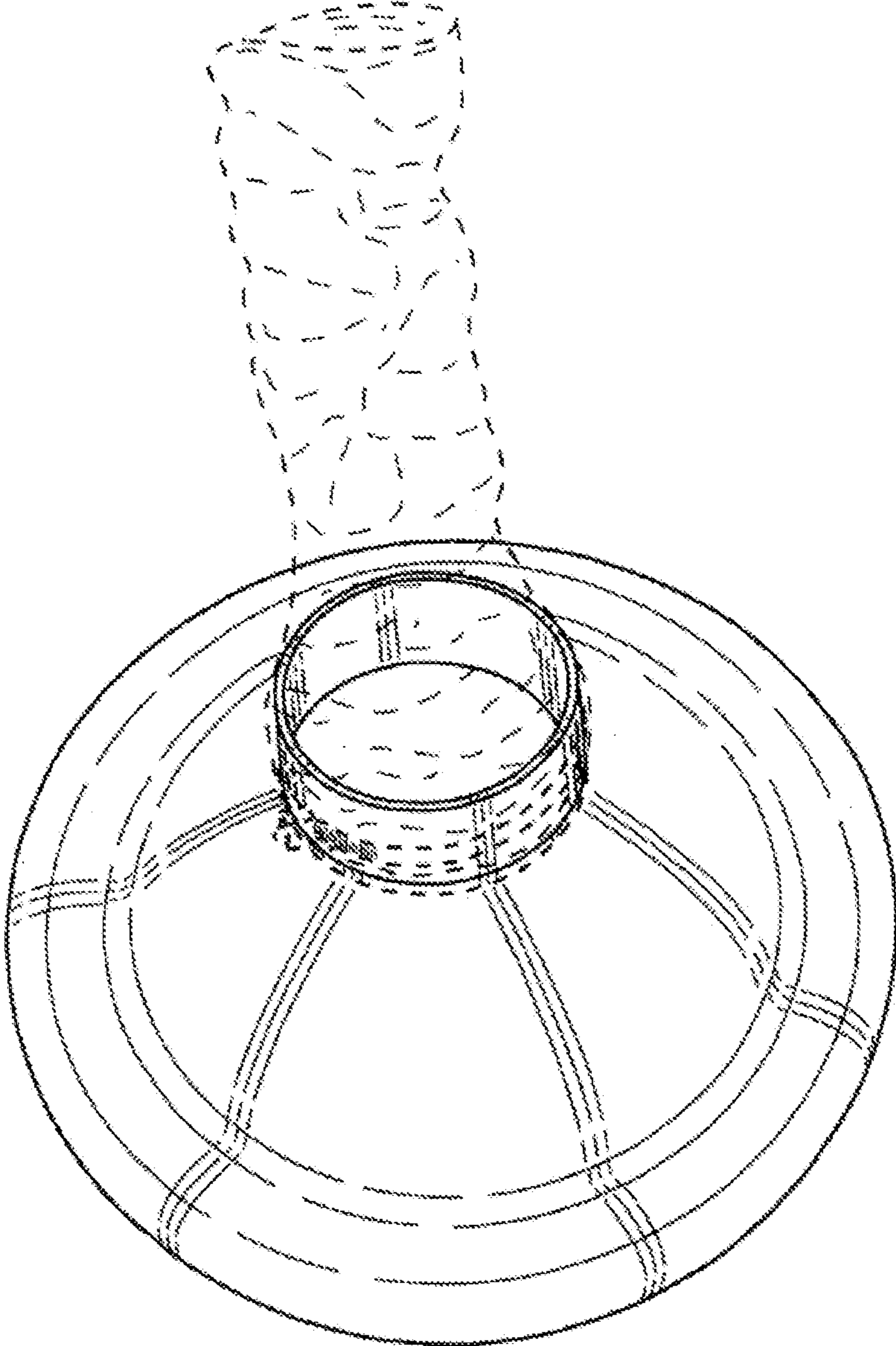

FIG.1

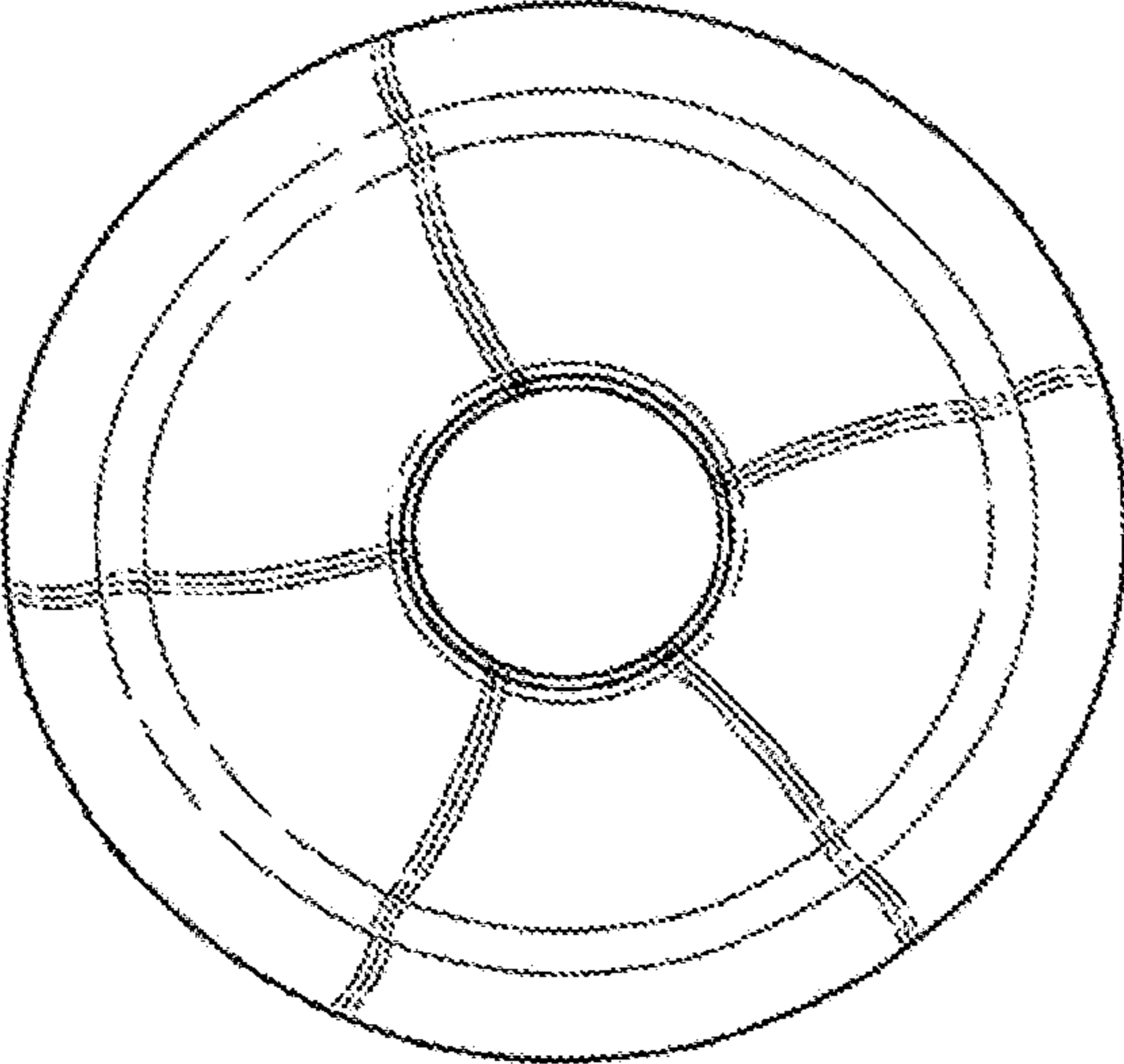

FIG.2

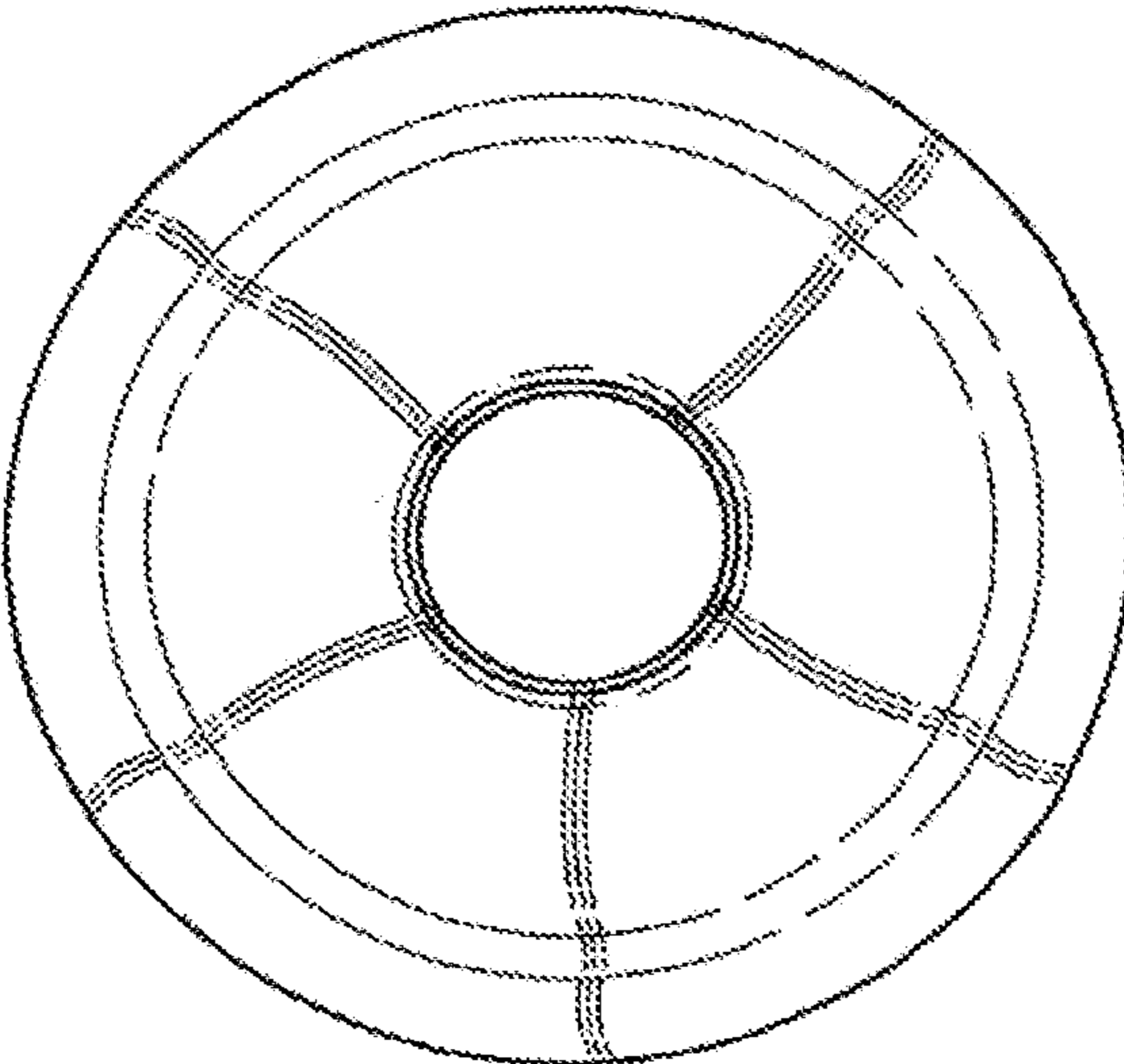

FIG.3

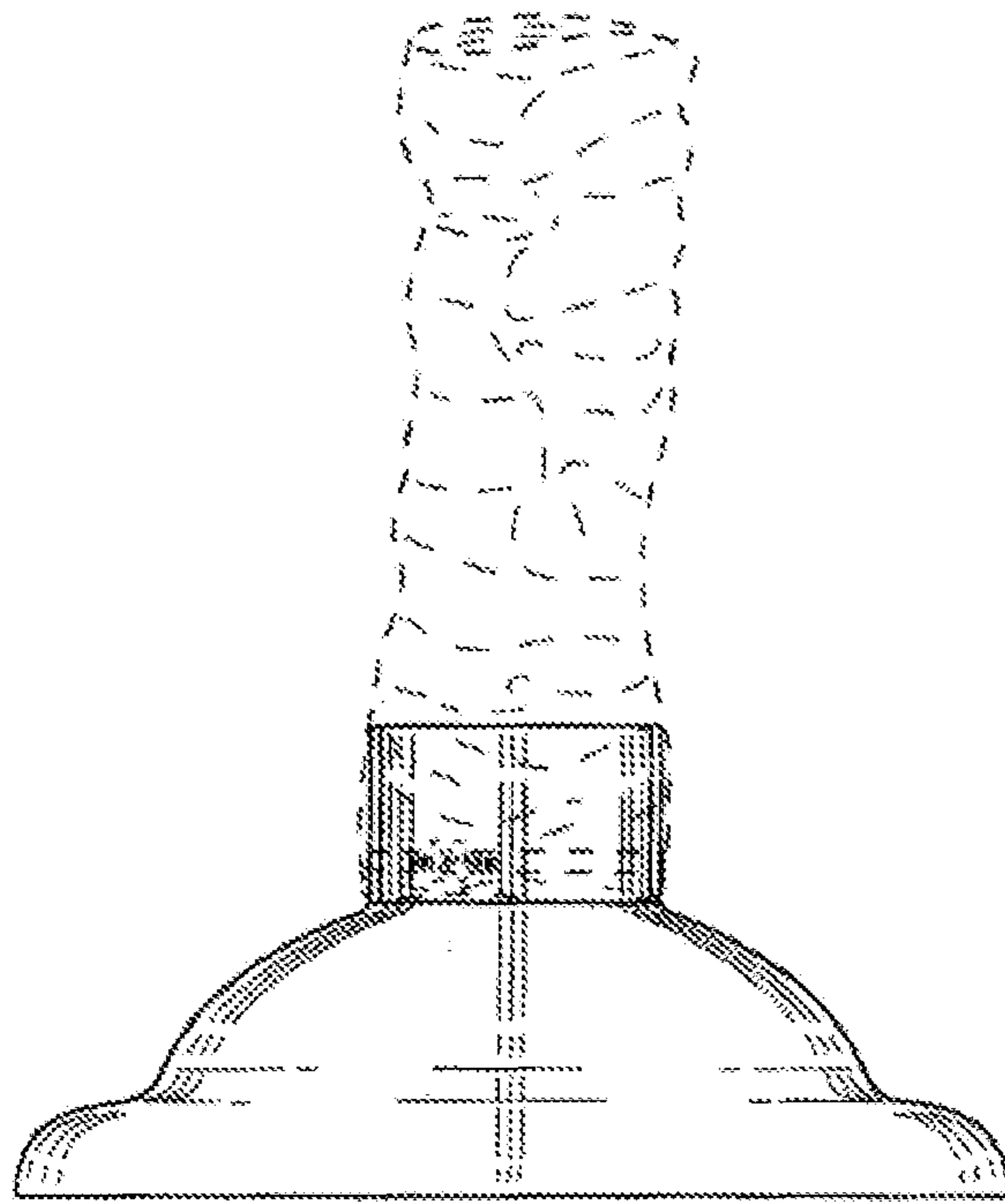

FIG. 4

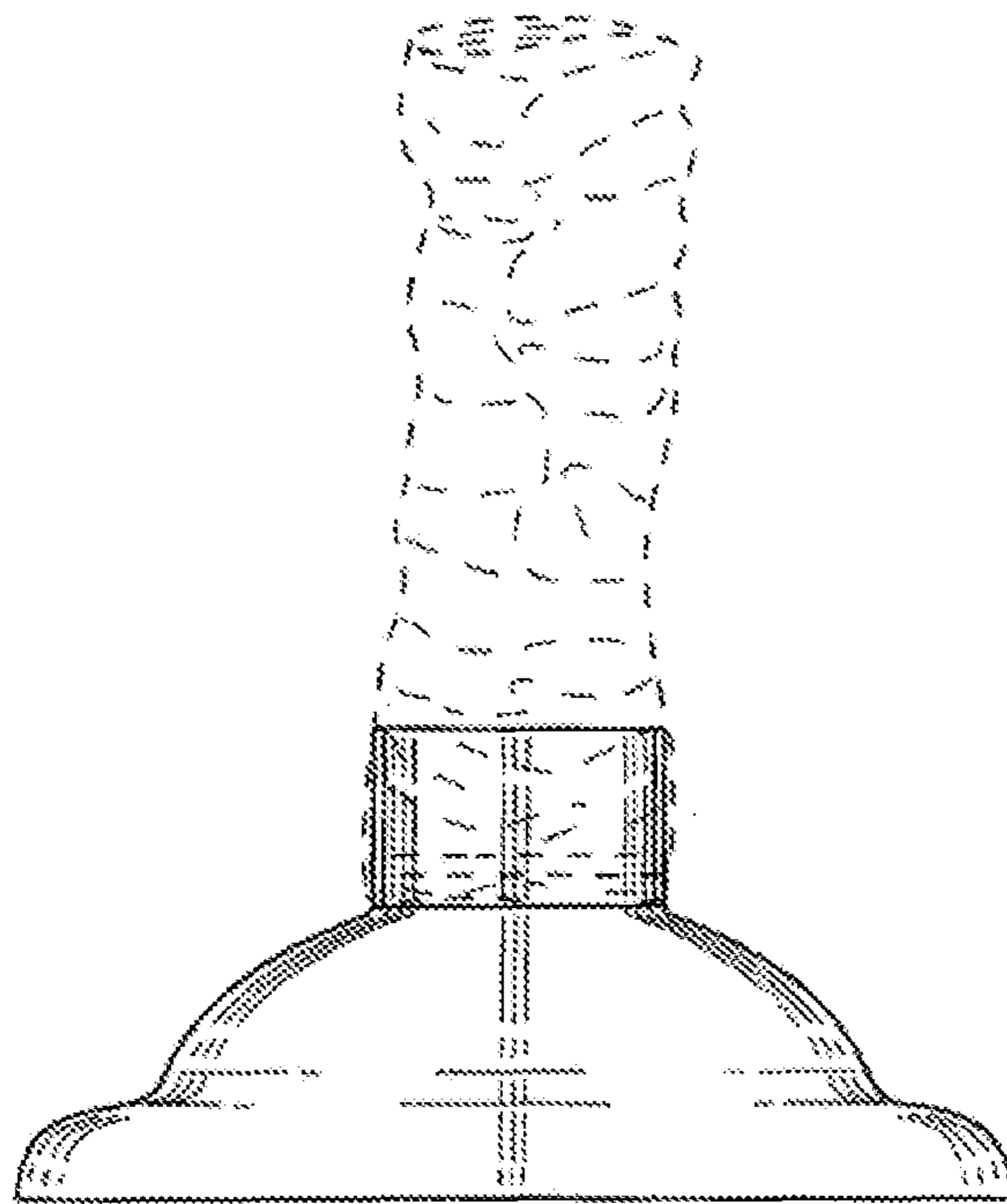

FIG. 5

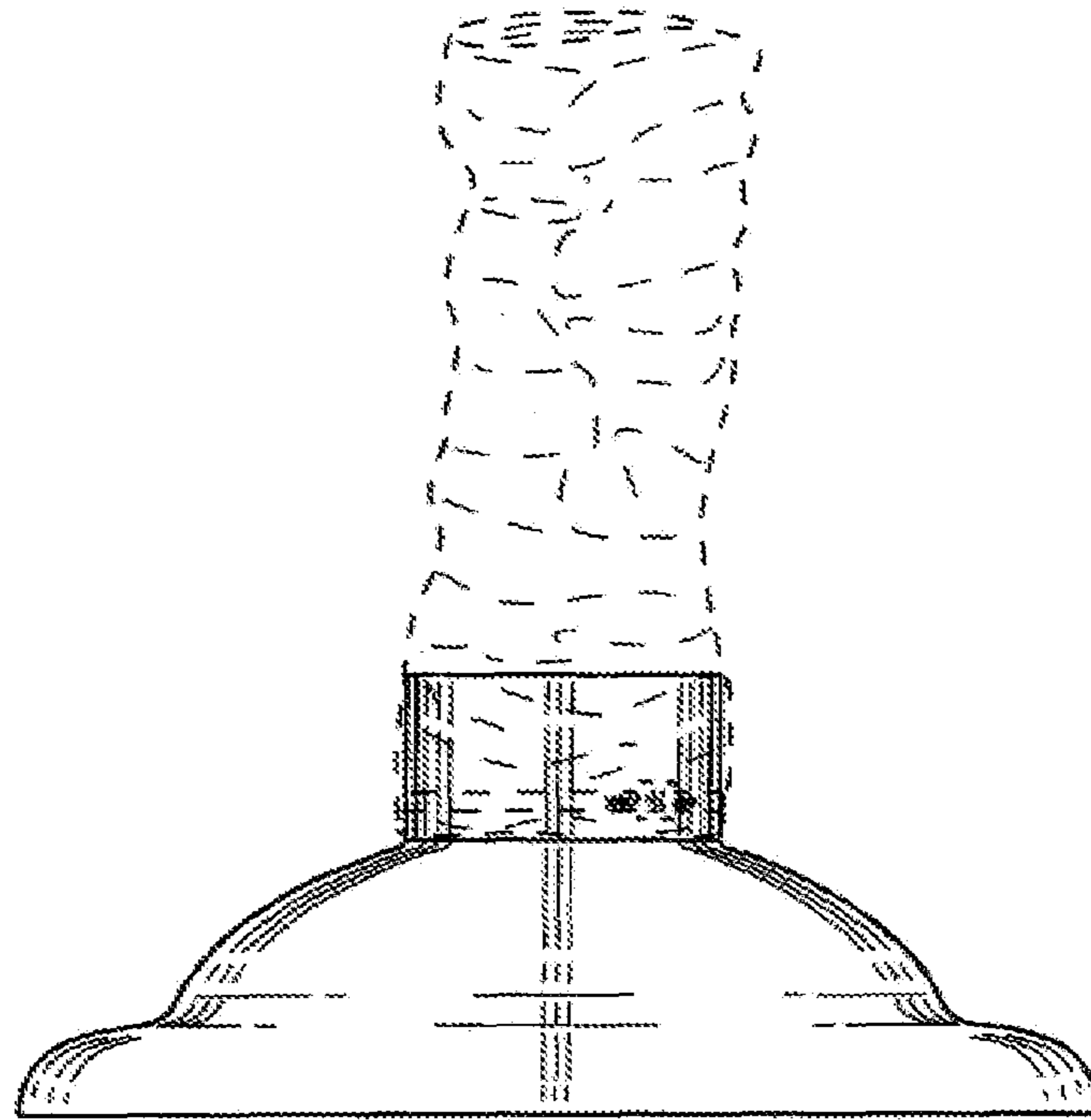

FIG. 6

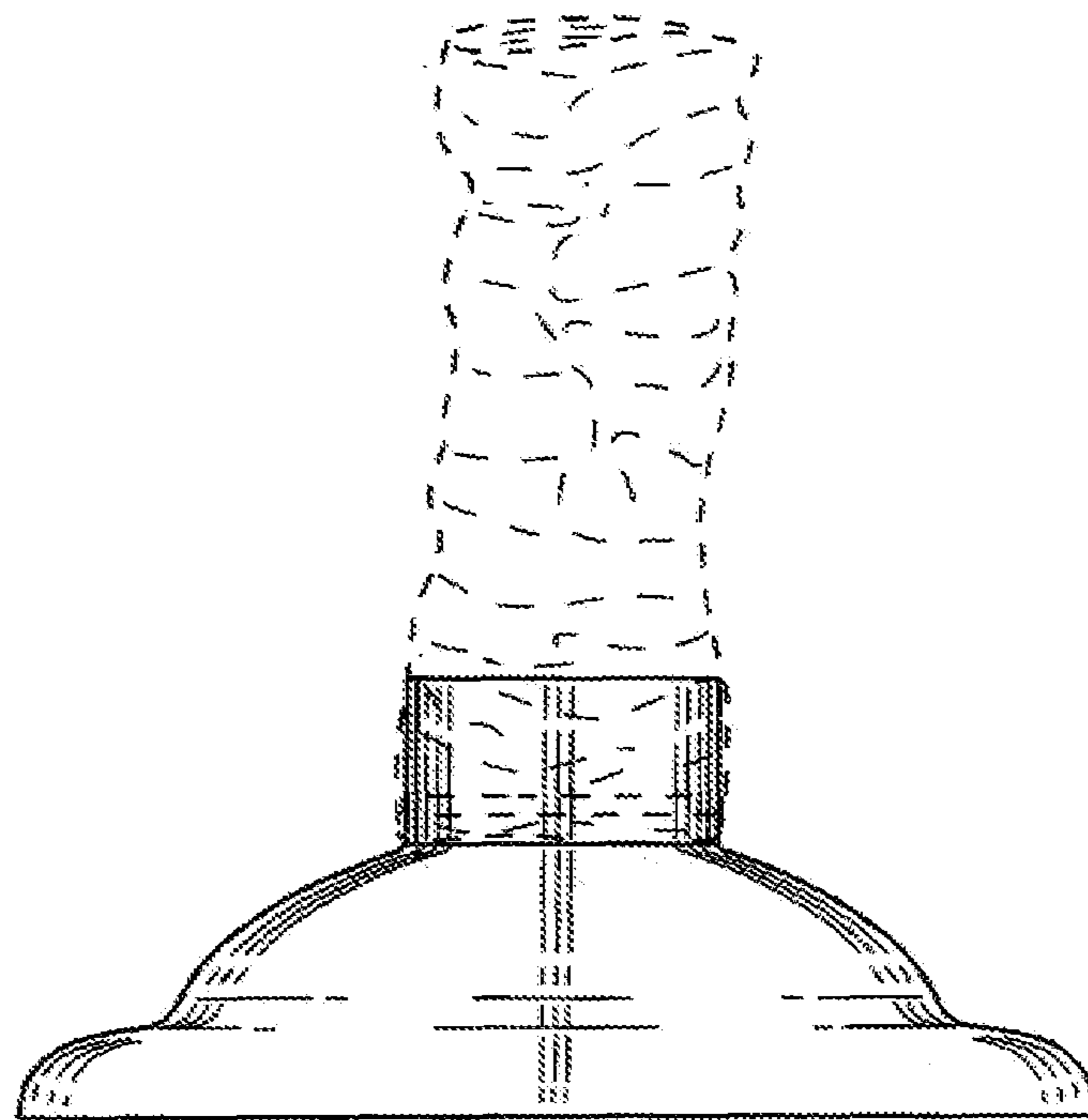

FIG. 7