



US00D699810S

(12) **United States Design Patent**
Monteleone

(10) **Patent No.:** **US D699,810 S**

(45) **Date of Patent:** **** Feb. 18, 2014**

(54) **DUMMY JIG HEAD**

(71) Applicant: **Picasso Lures, LLC**, Josephine, PA (US)

(72) Inventor: **Terry Monteleone**, Indiana, PA (US)

(73) Assignee: **Picasso Lures, LLC**, Josephine, PA (US)

(**) Term: **14 Years**

(21) Appl. No.: **29/448,543**

(22) Filed: **Mar. 13, 2013**

(51) **LOC (10) Cl.** **22-05**

(52) **U.S. Cl.**
USPC **D22/144**

(58) **Field of Classification Search**
USPC D22/144-146, 126-133; 43/42.36, 43/42.48, 42.45, 42.35, 42.37, 42.32, 43/42.39, 43.12, 42.06, 44.9, 44.82, 44.83, 43/42, 42.72, 36, 44.97

See application file for complete search history.

(56) **References Cited**

U.S. PATENT DOCUMENTS

2,590,558	A *	3/1952	Mickelson	43/44.82
2,841,915	A *	7/1958	Cohen	43/42.72
3,222,814	A *	12/1965	Rossnan	43/36
3,771,252	A *	11/1973	Odenwald	43/44.97
D456,058	S *	4/2002	Rollins	D22/122
D579,076	S *	10/2008	Altman	D22/144
D651,277	S *	12/2011	Voss	D22/145
D654,140	S *	2/2012	Rubel	D22/122
D682,981	S *	5/2013	Bernard	D22/122

* cited by examiner

Primary Examiner — Catheri Oliver-Garcia

(74) *Attorney, Agent, or Firm* — Buchanan Ingersoll & Rooney PC

(57) **CLAIM**

The ornamental design for a dummy jig head, as shown and described.

DESCRIPTION

FIG. 1 is a perspective view of a dummy jig head showing my new design; the dummy jig head shown with a center post; FIG. 2 is a right side elevational view thereof; FIG. 3 is a left side elevational view thereof; FIG. 4 is a top plan view thereof; FIG. 5 is a bottom plan view thereof; FIG. 6 is a rear view thereof; FIG. 7 is a front view thereof; FIG. 8 is a perspective view of an alternate embodiment of a dummy jig head showing my new design; the dummy jig head shown without the center post; FIG. 9 is a right side elevational view thereof; FIG. 10 is a left side elevational view thereof; FIG. 11 is a top plan view thereof; FIG. 12 is a bottom plan view thereof; FIG. 13 is a rear view thereof; FIG. 14 is a front view thereof; FIG. 15 is a perspective view of an alternate embodiment of FIG. 1 to more fully illustrate the dummy jig head with an alternate head of a jig; and, FIG. 16 is a perspective view of an alternate embodiment of FIG. 8 to more fully illustrate the dummy jig head with an alternate head of a jig.

The phantom lines in FIGS. 1 through 16 are for illustrative purposes only to show a sample head of a jig and form no part of the claimed design.

1 Claim, 5 Drawing Sheets

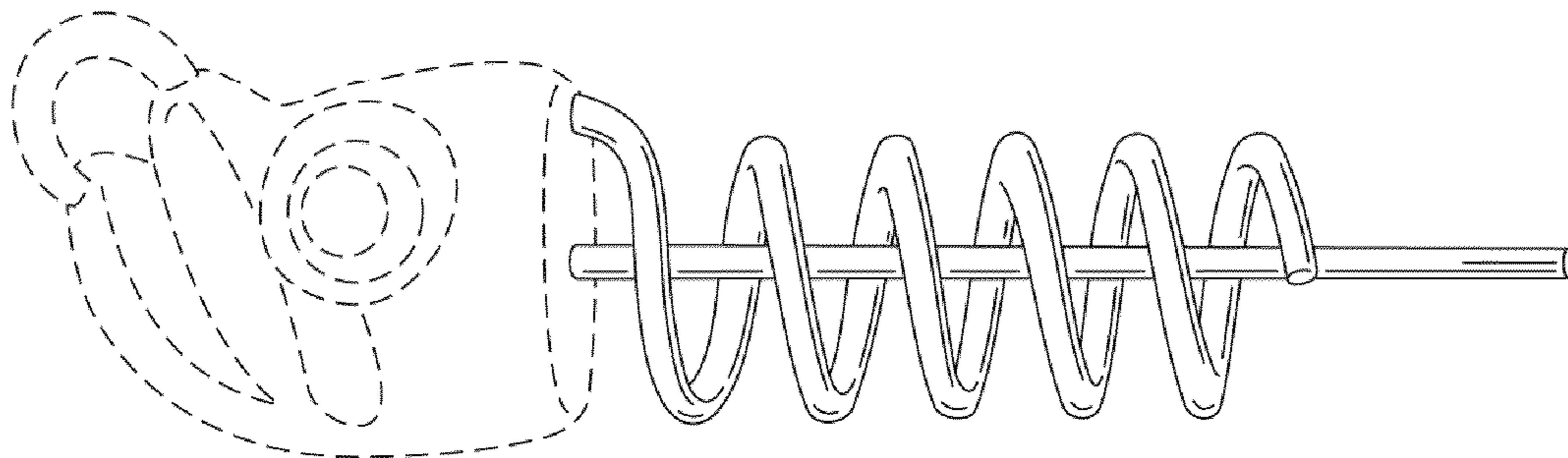

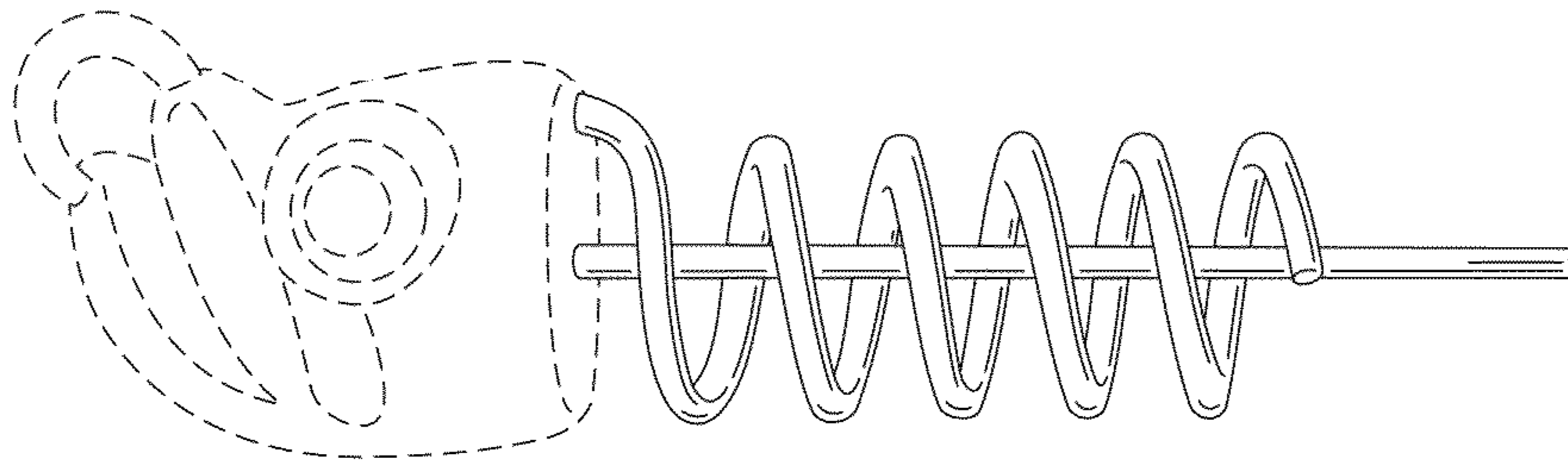

FIG. 1

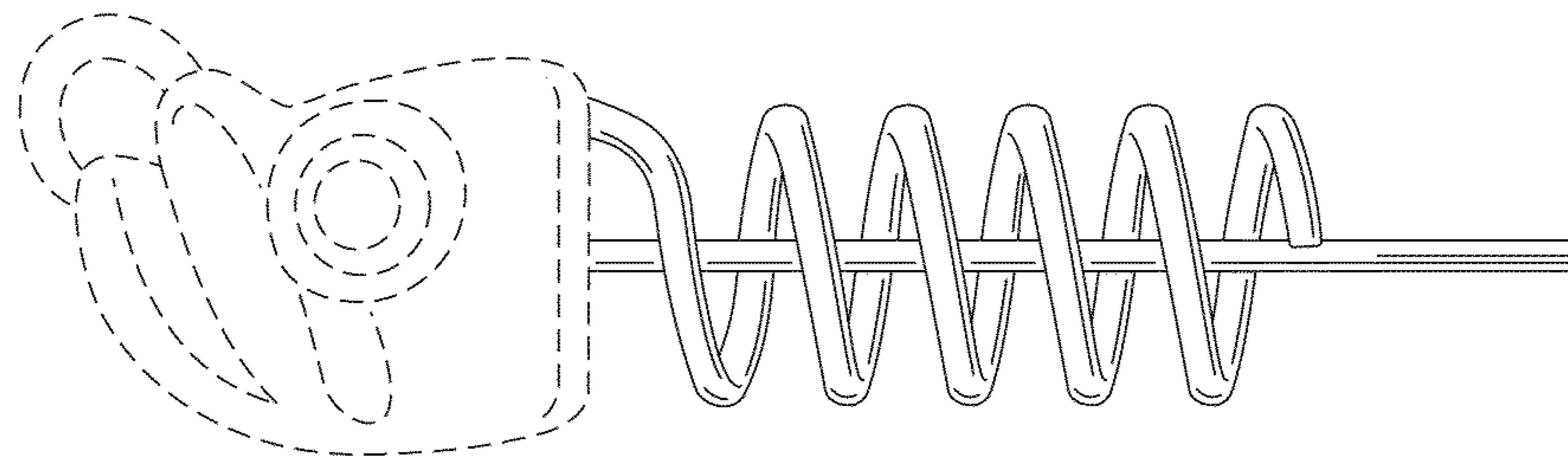

FIG. 2

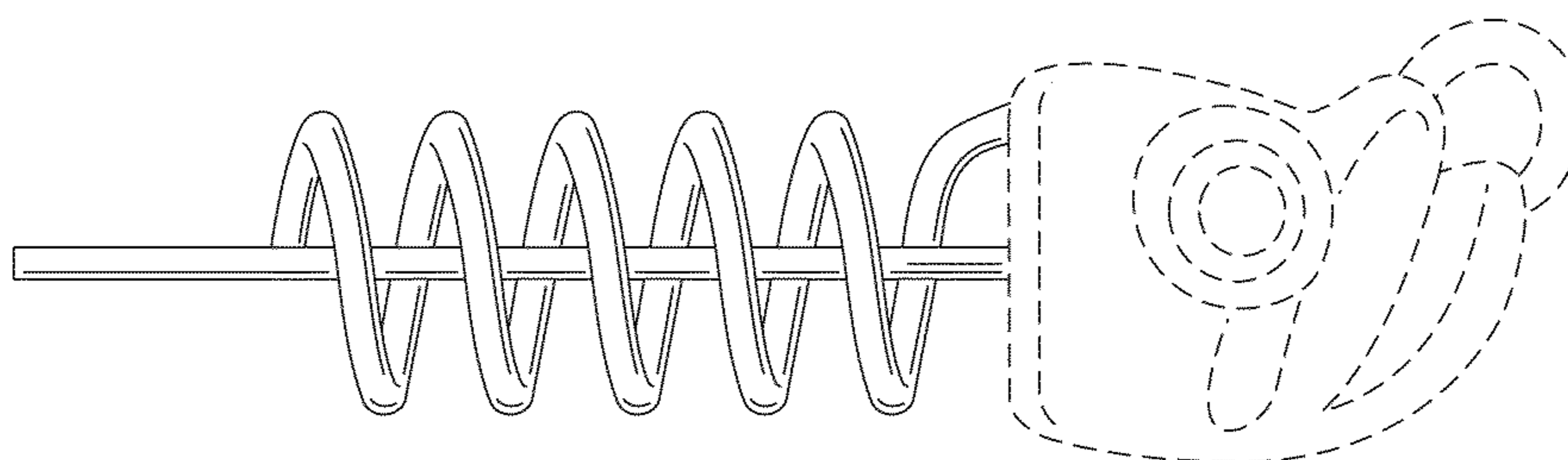

FIG. 3

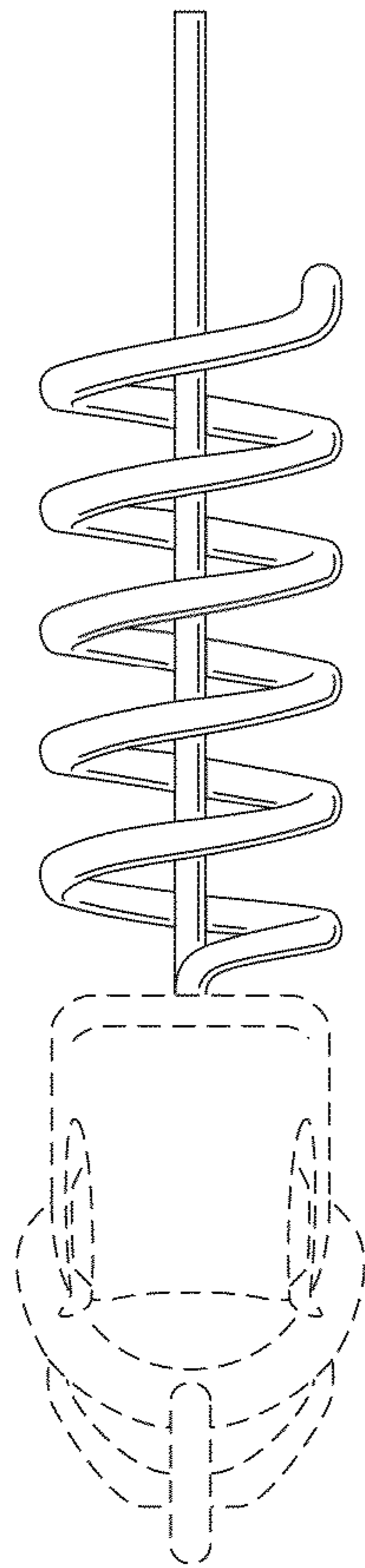

FIG. 4

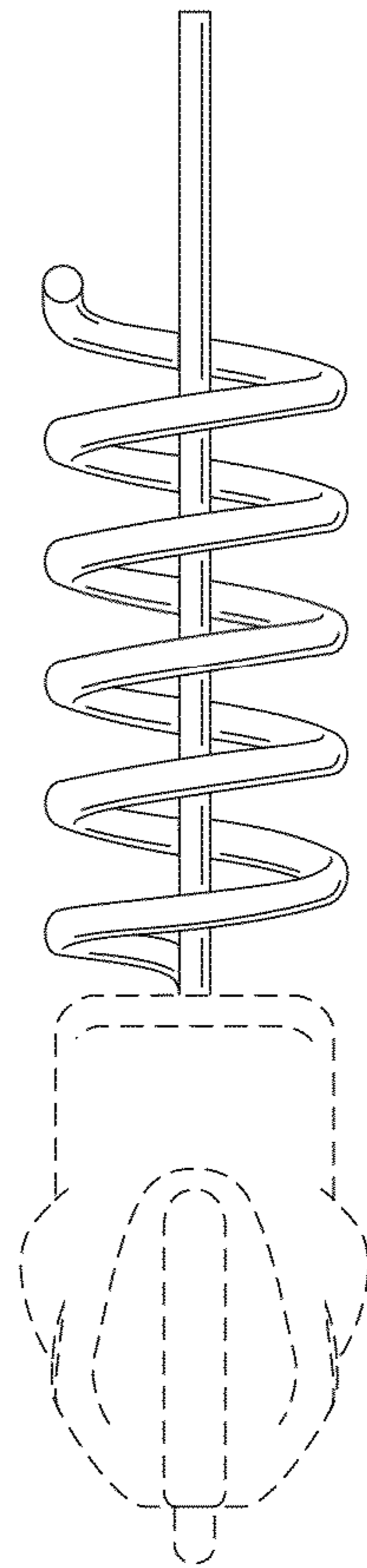

FIG. 5

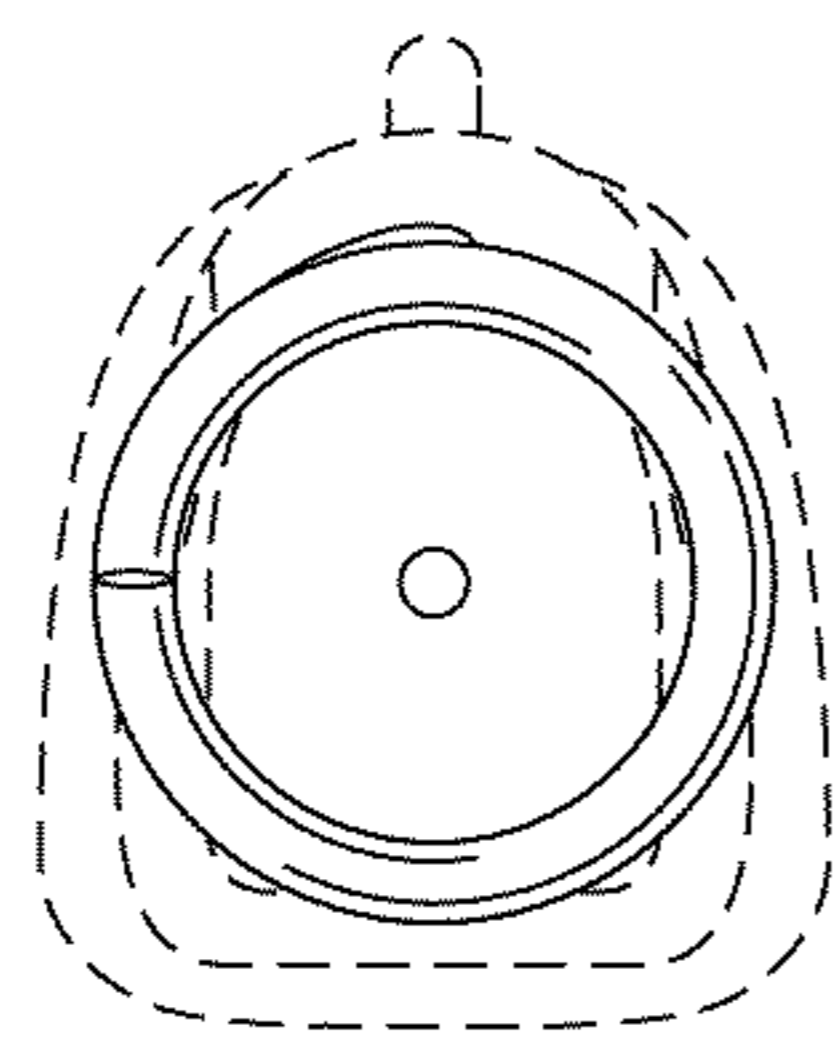

FIG. 6

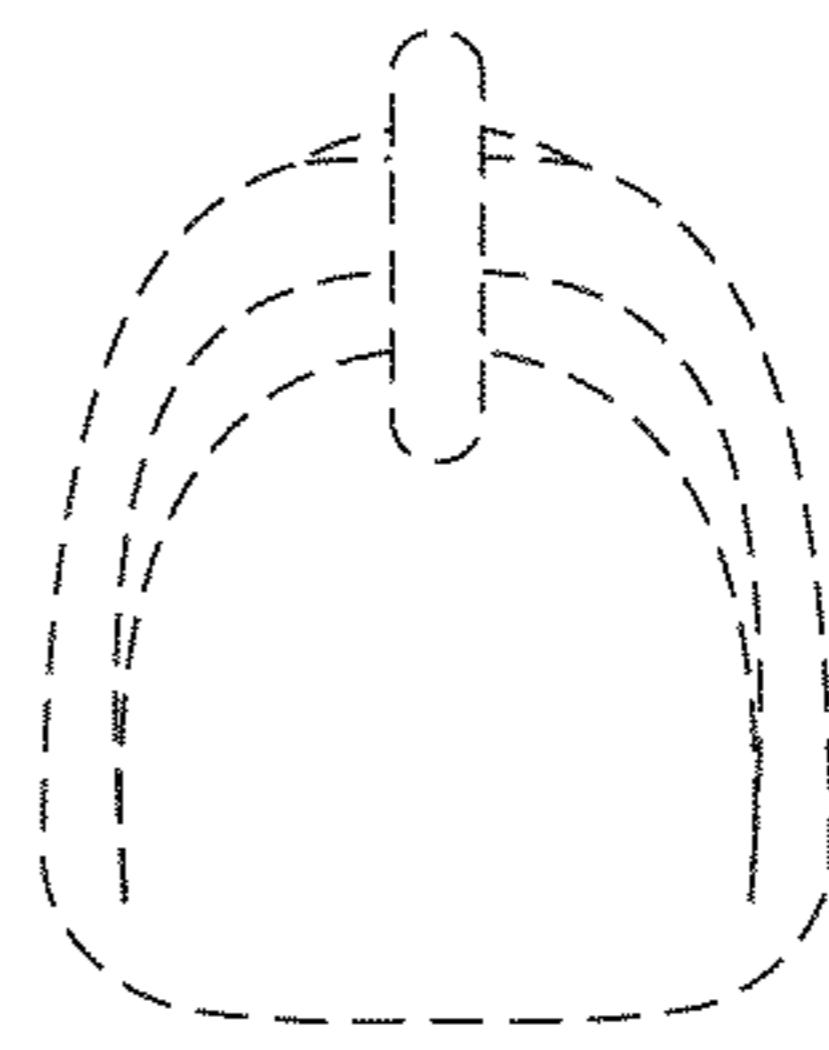

FIG. 7

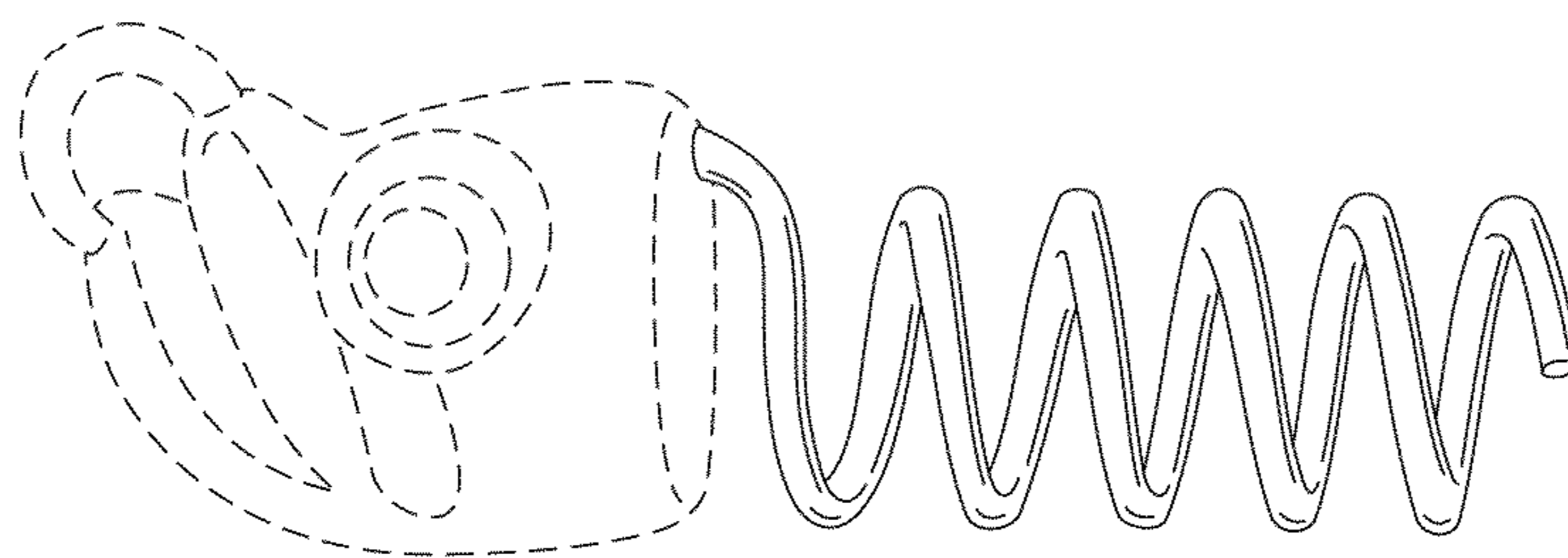

FIG. 8

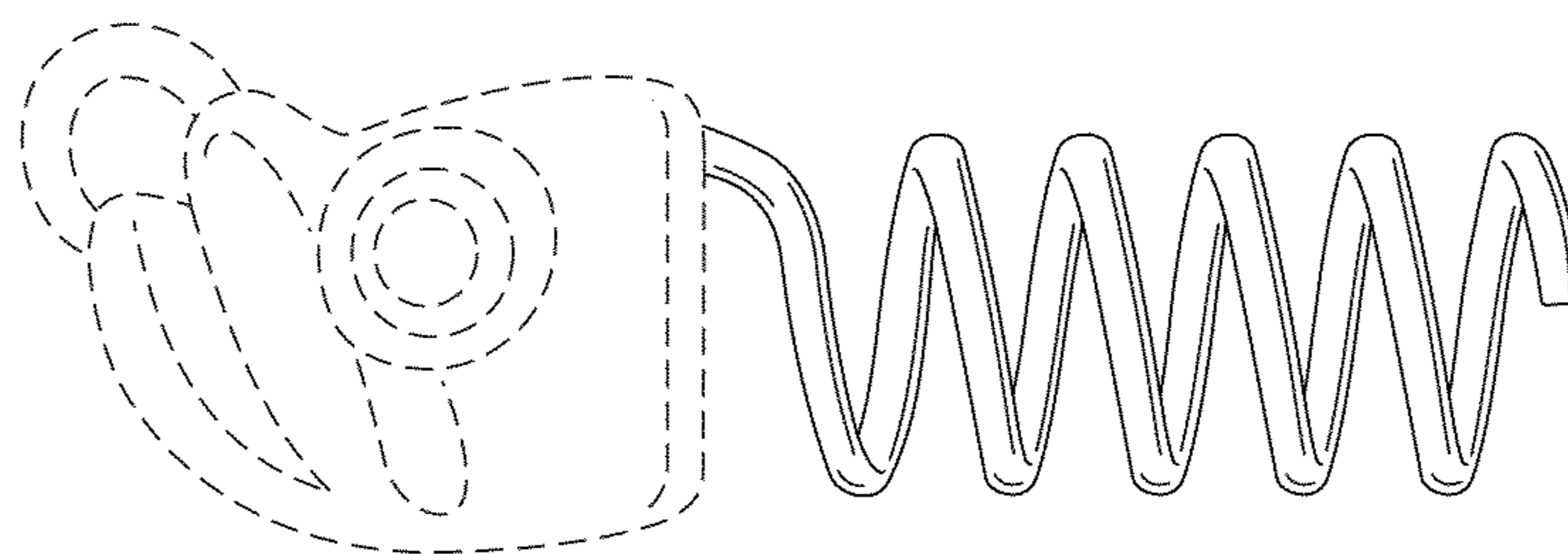

FIG. 9

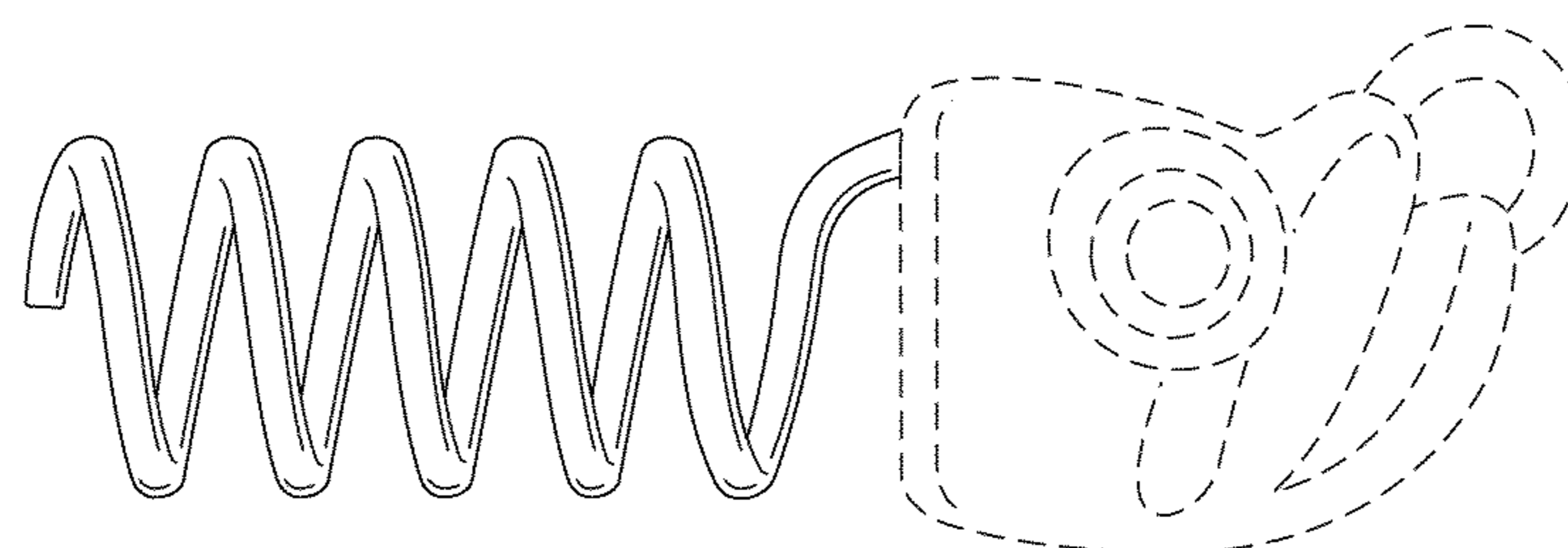

FIG. 10

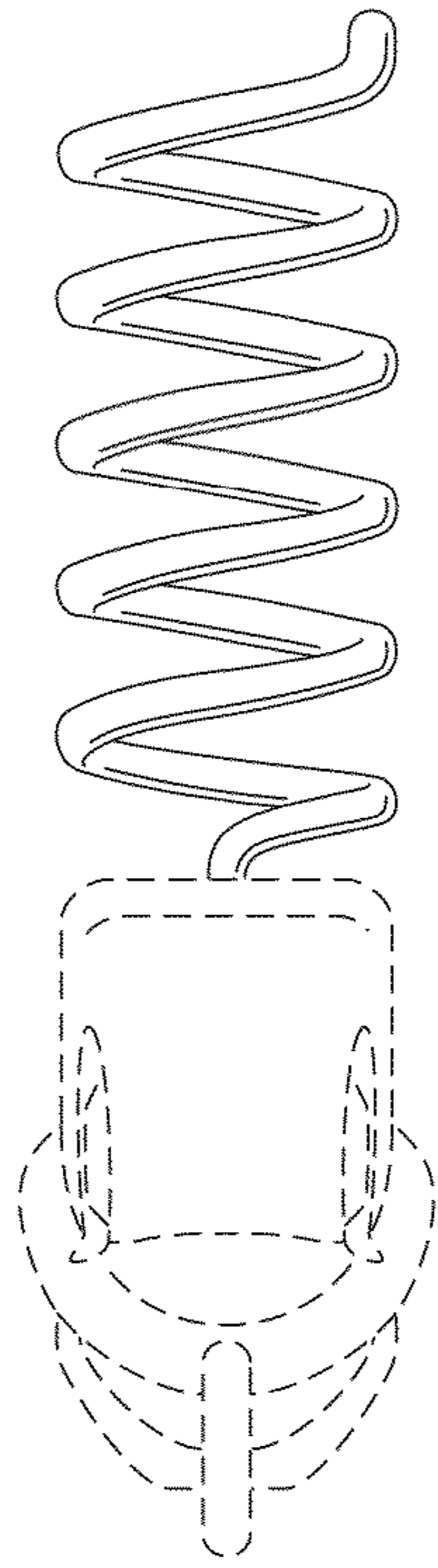

FIG. 11

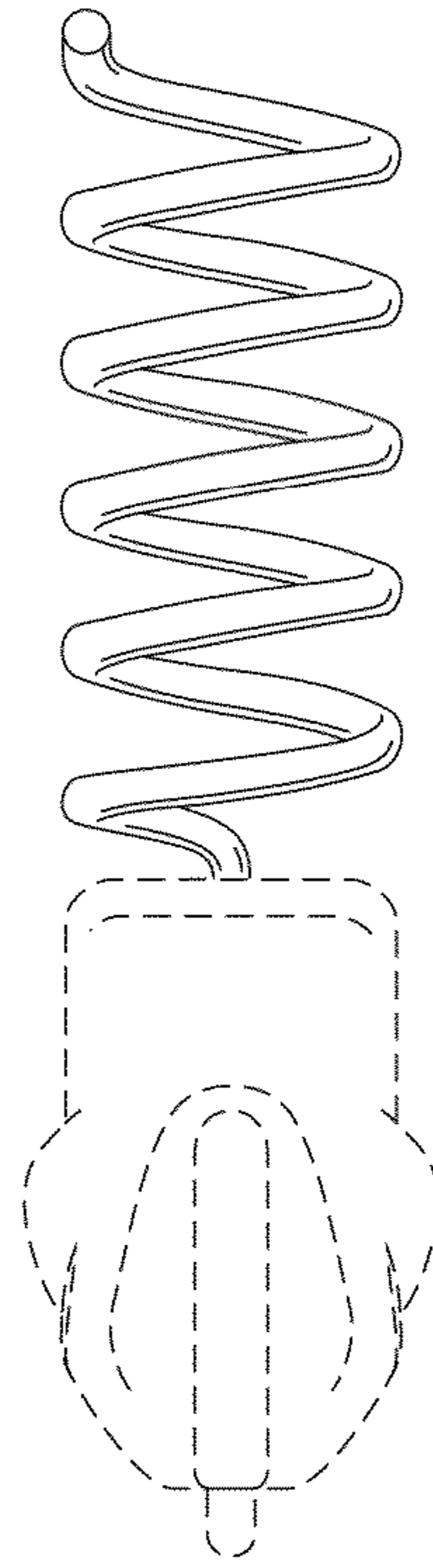

FIG. 12

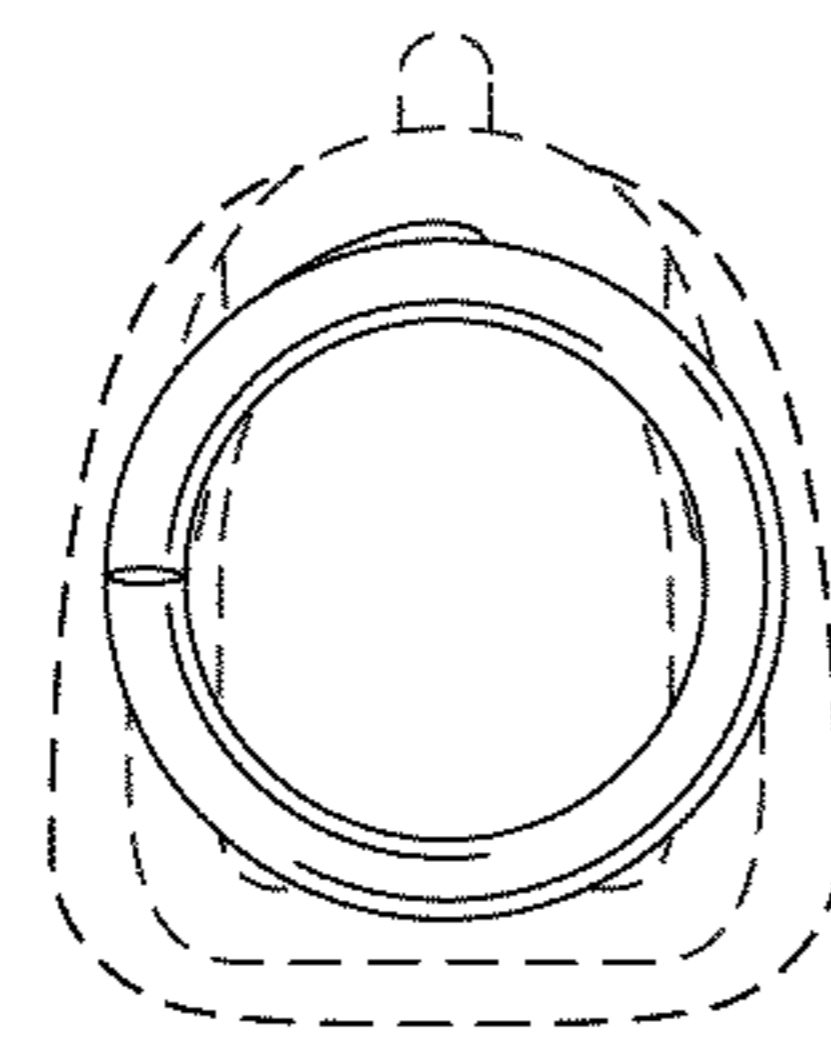

FIG. 13

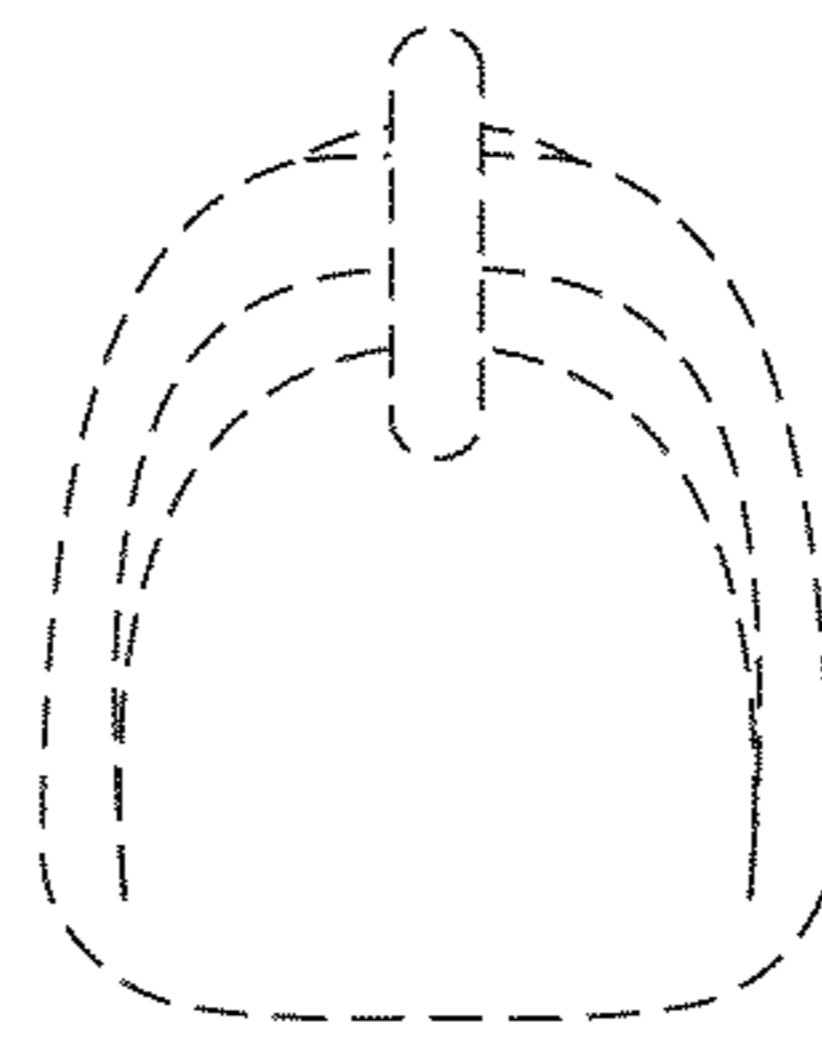

FIG. 14

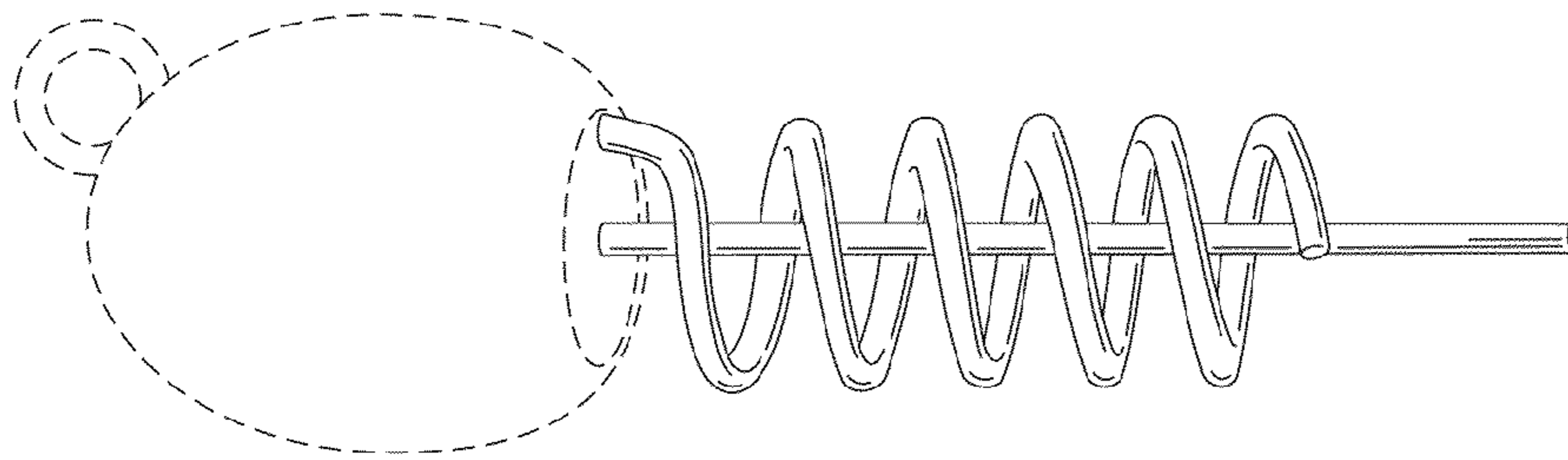

FIG. 15

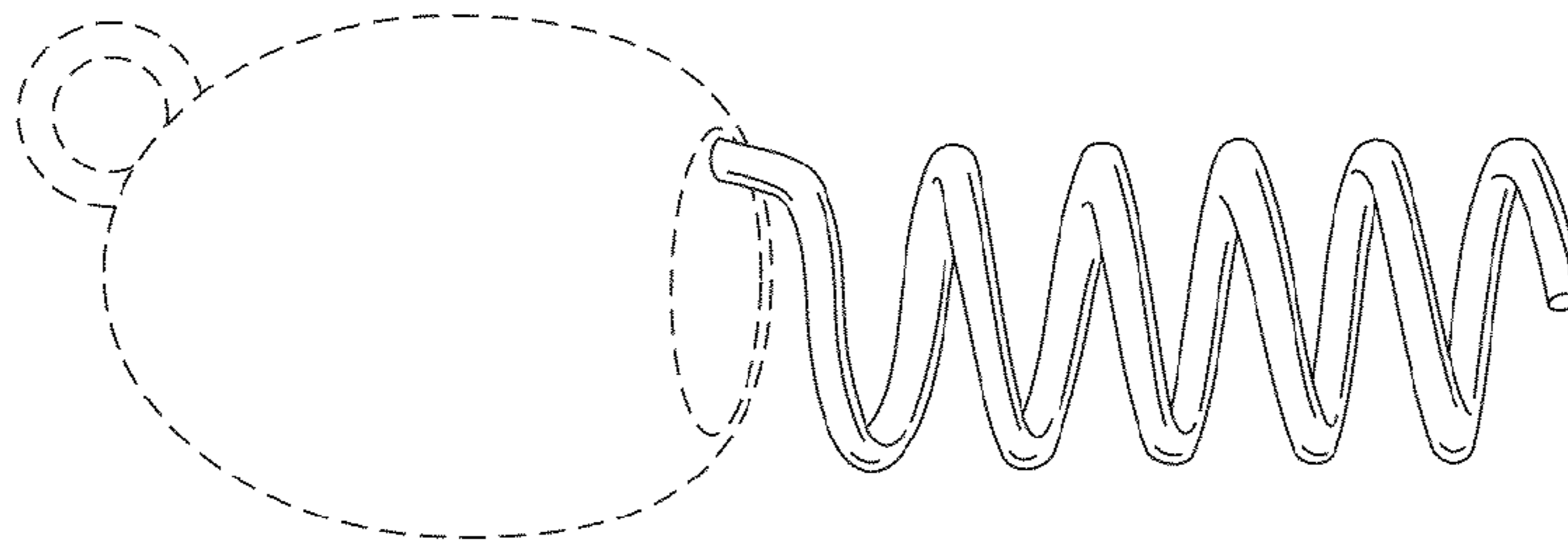

FIG. 16