



US00D699808S

(12) **United States Design Patent**
Nordwall et al.

(10) **Patent No.:** **US D699,808 S**
(45) **Date of Patent:** **** Feb. 18, 2014**

- (54) **KNIFE WITH INTEGRATED FIRE IRON**
- (75) Inventors: **Joachim Nordwall**, Stockholm (SE);
Roger Wikström, Älvdalen (SE)
- (73) Assignee: **Light My Fire Sweden AB**, Malmö (SE)
- (**) Term: **14 Years**
- (21) Appl. No.: **29/411,492**
- (22) Filed: **Jan. 20, 2012**
- (51) **LOC (10) Cl.** **22-02**
- (52) **U.S. Cl.**
USPC **D22/118**
- (58) **Field of Classification Search**
USPC D22/118; D8/93-99; D3/220; 30/123.6,
30/136.5, 151-152, 154, 276, 294, 314,
30/340
See application file for complete search history.

(56) **References Cited**

U.S. PATENT DOCUMENTS

D379,294 S *	5/1997	Lum	D8/99
D488,205 S *	4/2004	Skowronski	D22/118
D591,040 S *	4/2009	Foster et al.	D3/220
D638,903 S *	5/2011	Norling	D22/118
D654,144 S *	2/2012	Karlsson et al.	D22/118
2006/0080840 A1 *	4/2006	Freeman	30/151

* cited by examiner

Primary Examiner — Catheri Oliver-Garcia
(74) *Attorney, Agent, or Firm* — Holland & Hart LLP

(57) **CLAIM**

The ornamental design for a knife with integrated fire iron, as shown and described.

DESCRIPTION

FIG. 1 is a top perspective view of the knife with integrated fire iron, showing my new design;

FIG. 2 is another top perspective view of the design illustrated in FIG. 1;

FIG. 3 is a right side view of the design illustrated in FIG. 1;

FIG. 4 is a front view of the design illustrated in FIG. 1;

FIG. 5 is a left side view of the design illustrated in FIG. 1;

FIG. 6 is a top view of the design illustrated in FIG. 1;

FIG. 7 is a rear view of the design illustrated in FIG. 1;

FIG. 8 is a bottom view of the design illustrated in FIG. 1;

FIG. 9 is a left side perspective view of the design illustrated in FIG. 1;

FIG. 10 is a right side perspective view of the design illustrated in FIG. 1 with the fire iron removed;

FIG. 11 is a top perspective view of the fire iron of FIG. 10;

FIG. 12 is a right side view of the fire iron of FIG. 10;

FIG. 13 is a front view of the fire iron of FIG. 10;

FIG. 14 is a left side view of the fire iron of FIG. 10;

FIG. 15 is a top view of the fire iron of FIG. 10;

FIG. 16 is a rear view of the fire iron of FIG. 10;

FIG. 17 is a bottom view of the fire iron of FIG. 10;

FIG. 18 is a top rear perspective view of the fire iron of FIG. 10;

FIG. 19 is a top perspective view of the knife with integrated fire iron and a sheath, showing my new design;

FIG. 20 is a right side view of the design illustrated in FIG. 19;

FIG. 21 is a front view of the design illustrated in FIG. 19;

FIG. 22 is a left side view of the design illustrated in FIG. 19;

FIG. 23 is a top view of the design illustrated in FIG. 19;

FIG. 24 is a rear view of the design illustrated in FIG. 19;

FIG. 25 is a bottom view of the design illustrated in FIG. 19;

FIG. 26 is a top perspective view of the knife with integrated fire iron and a sheath, showing another embodiment of my new design; and,

FIG. 27 is a right side view of the design illustrated in FIG. 26, the front, left side, top, rear, and bottom views being identical to the views of FIGS. 21 through 25, respectively.

1 Claim, 27 Drawing Sheets

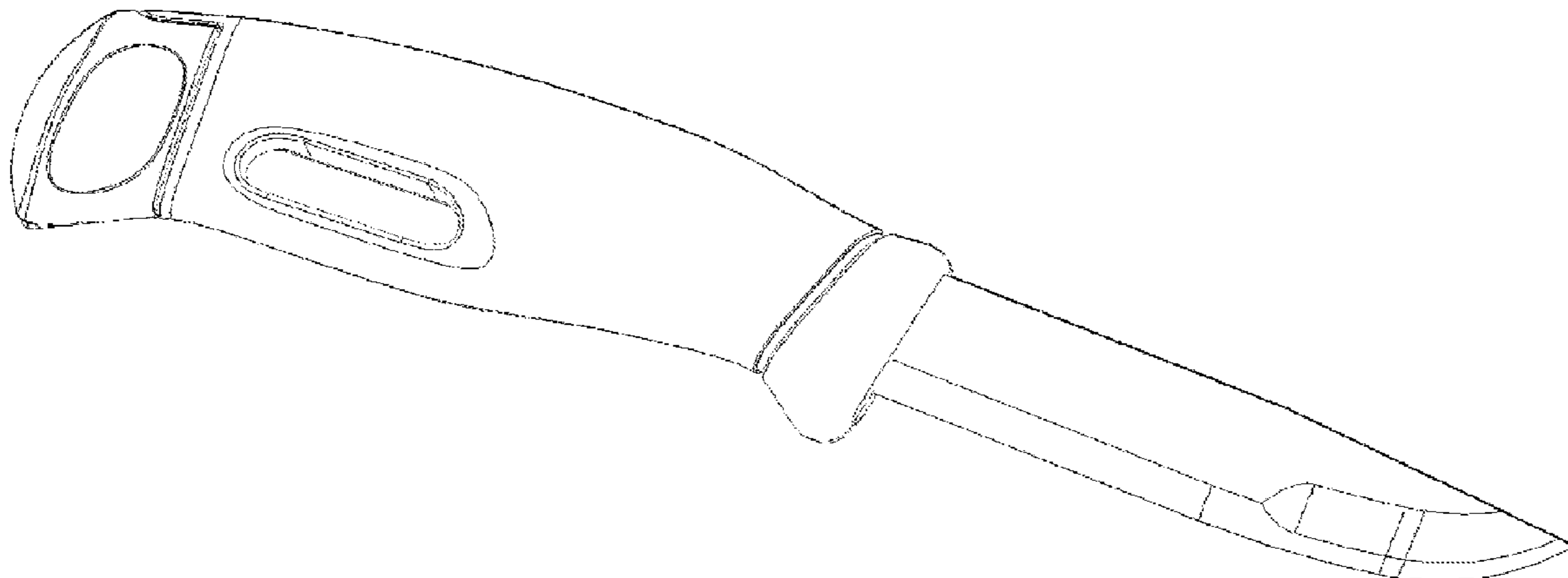

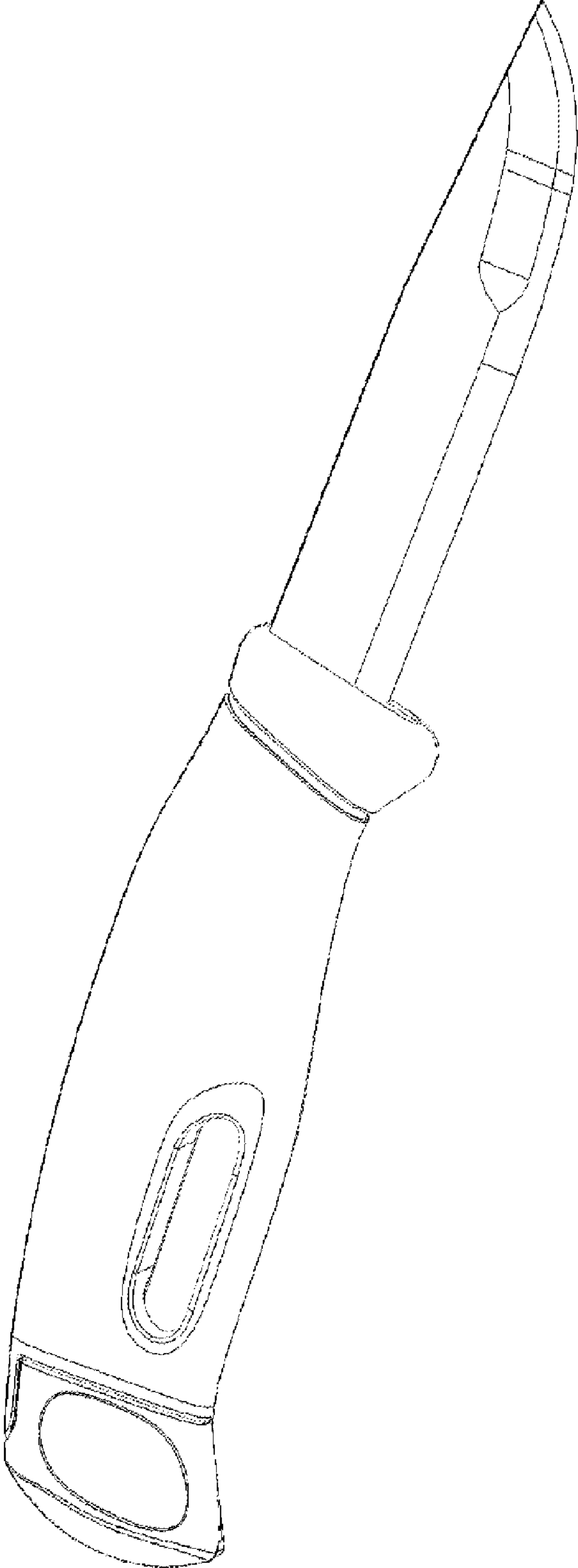

FIG. 1

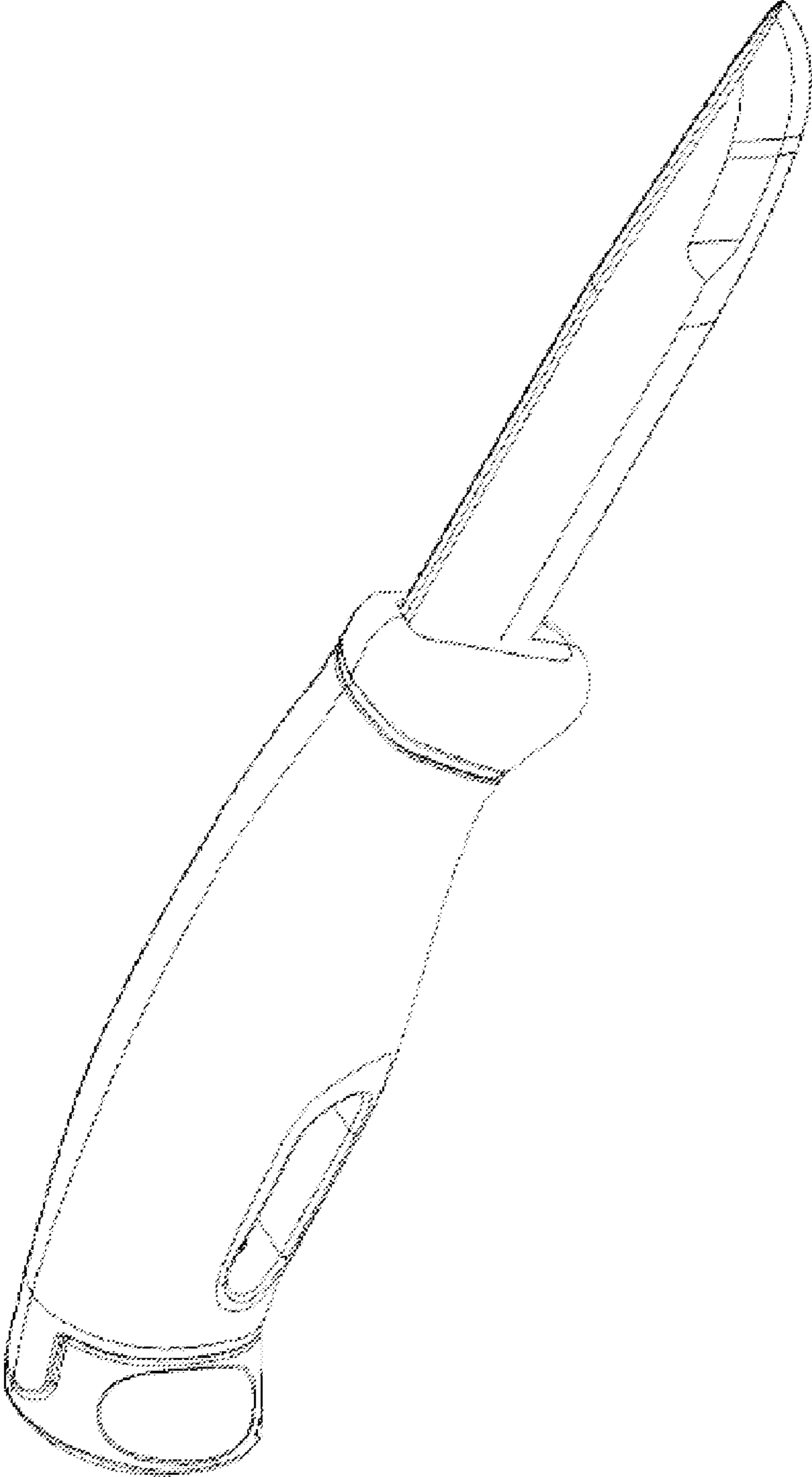

FIG. 2

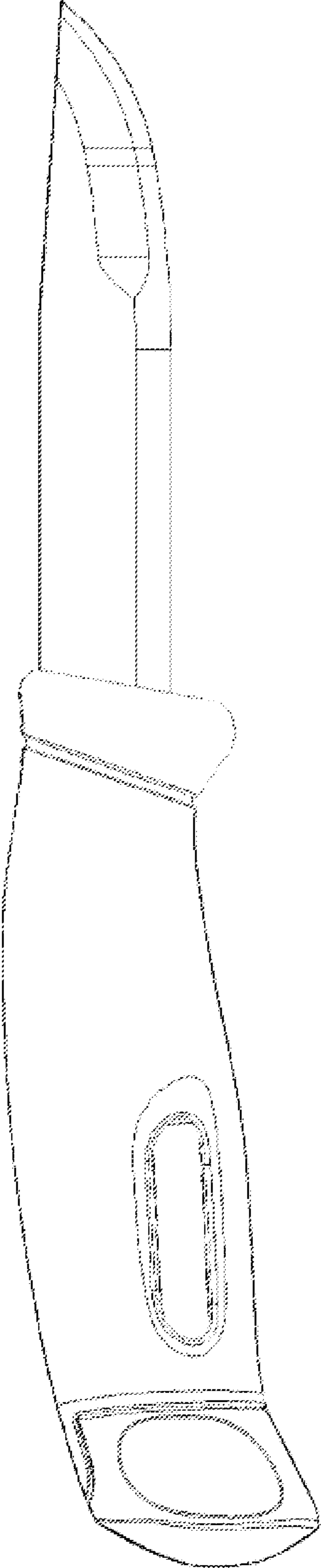

FIG. 3



FIG. 4

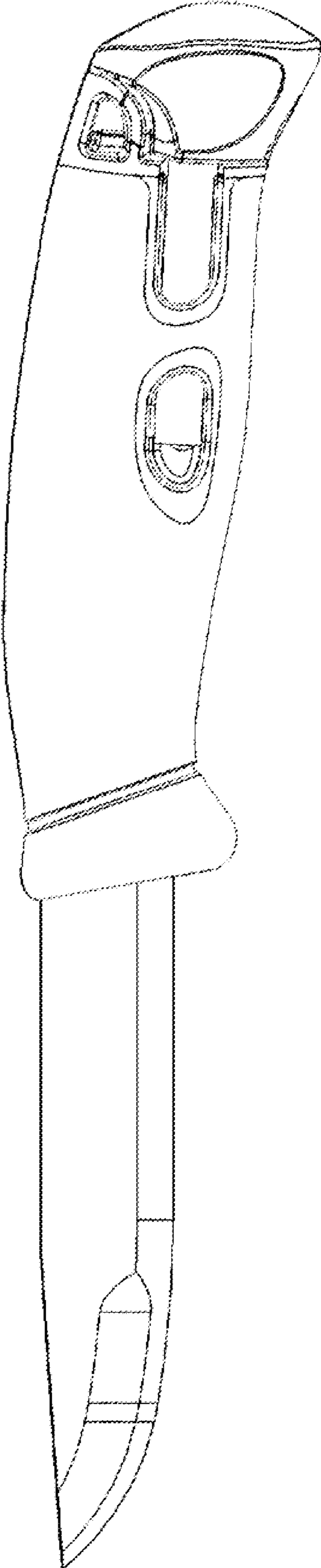

FIG. 5

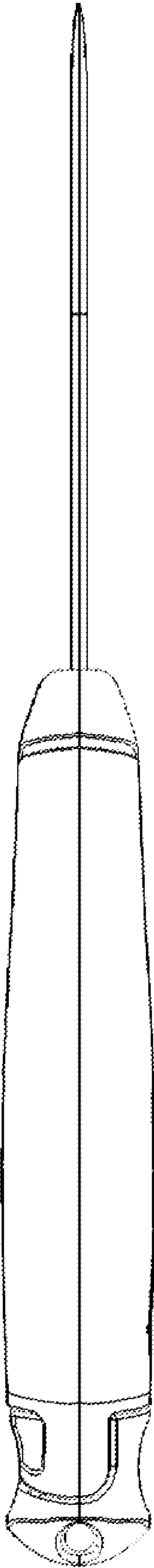

FIG. 6

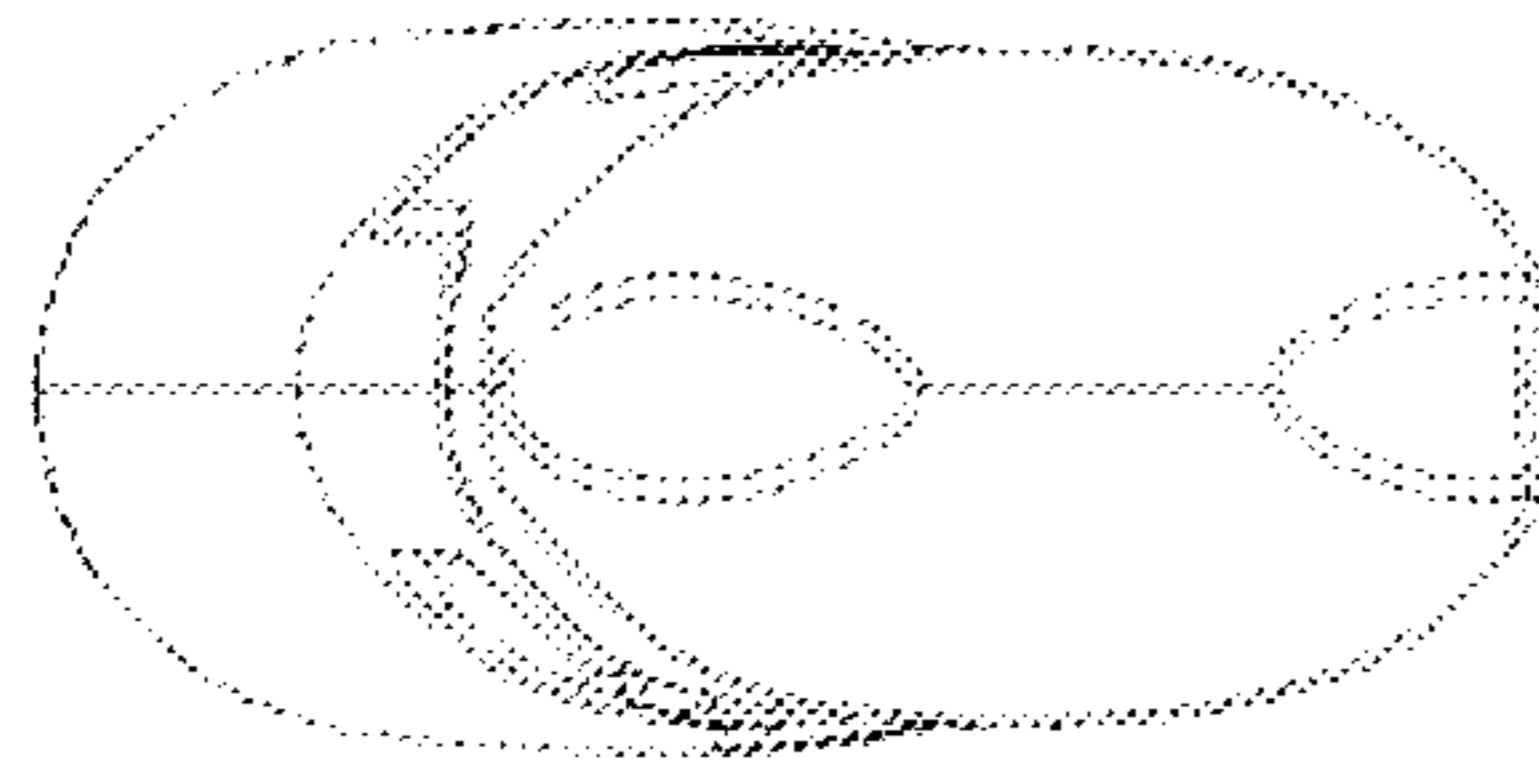

FIG. 7

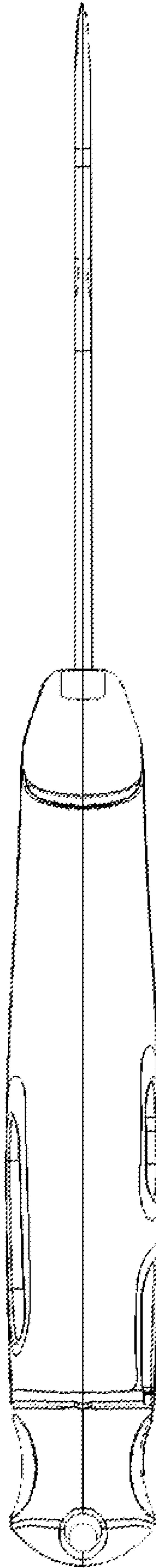

FIG. 8

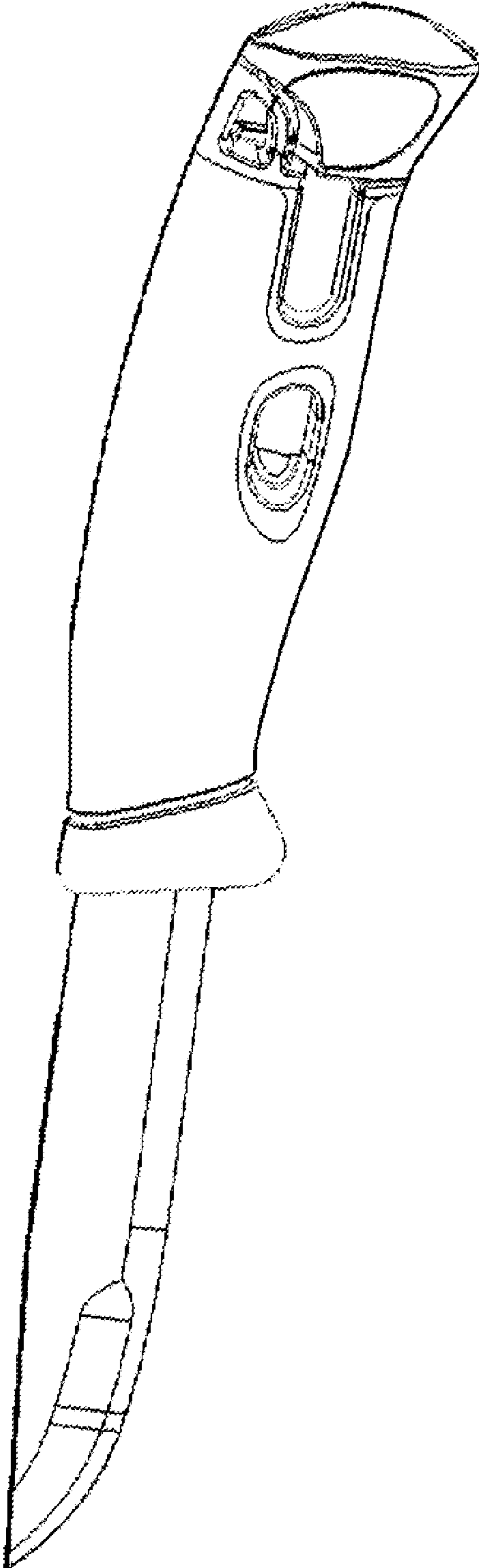

FIG. 9

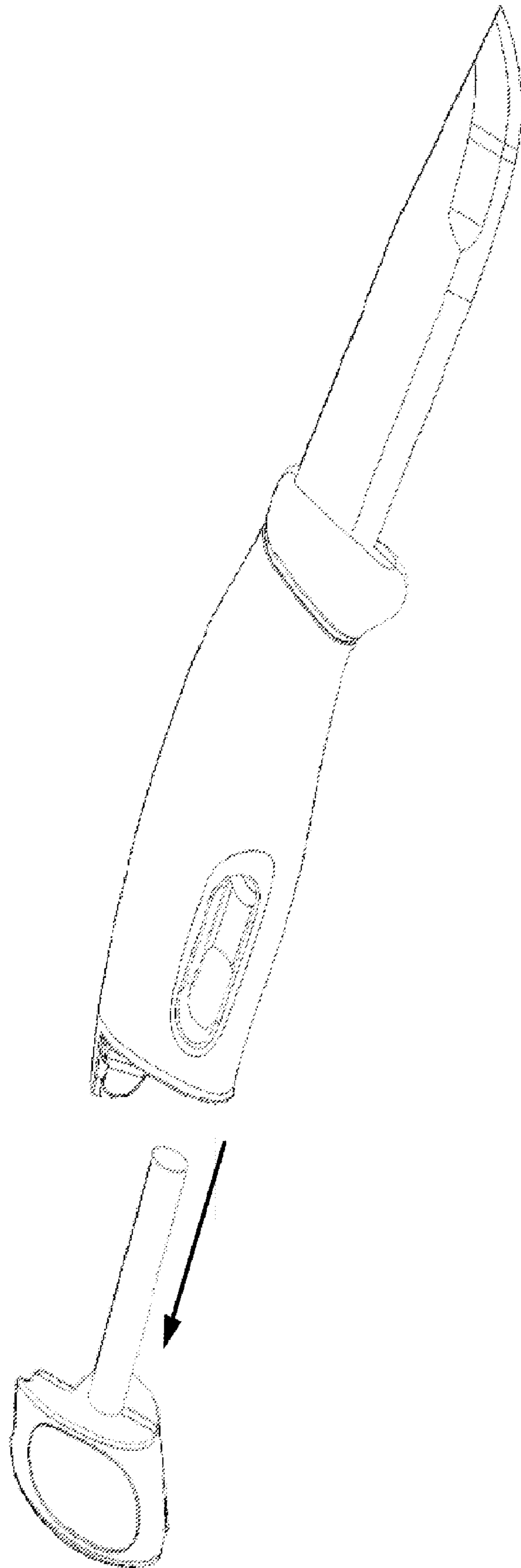

FIG. 10

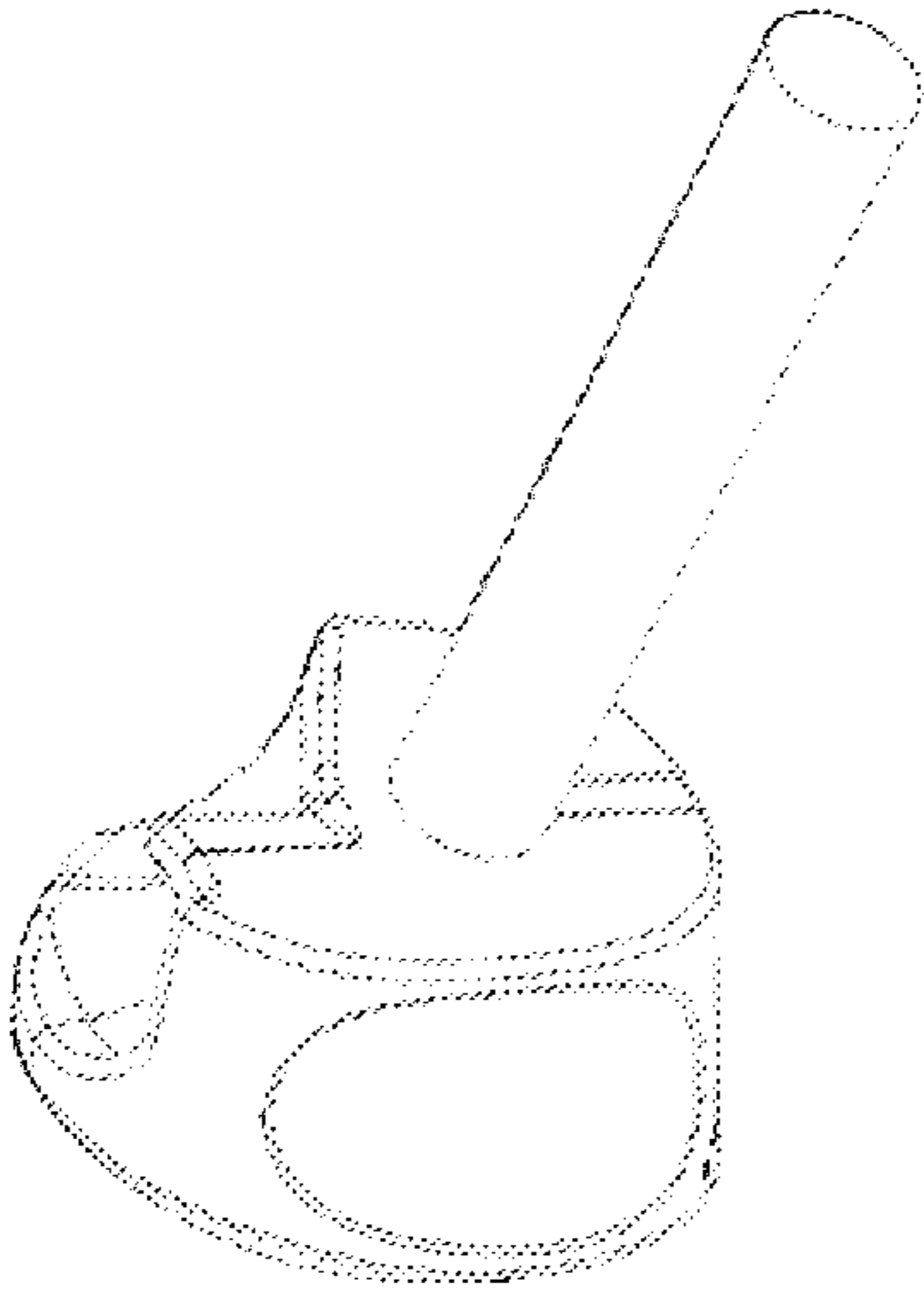

FIG. 11

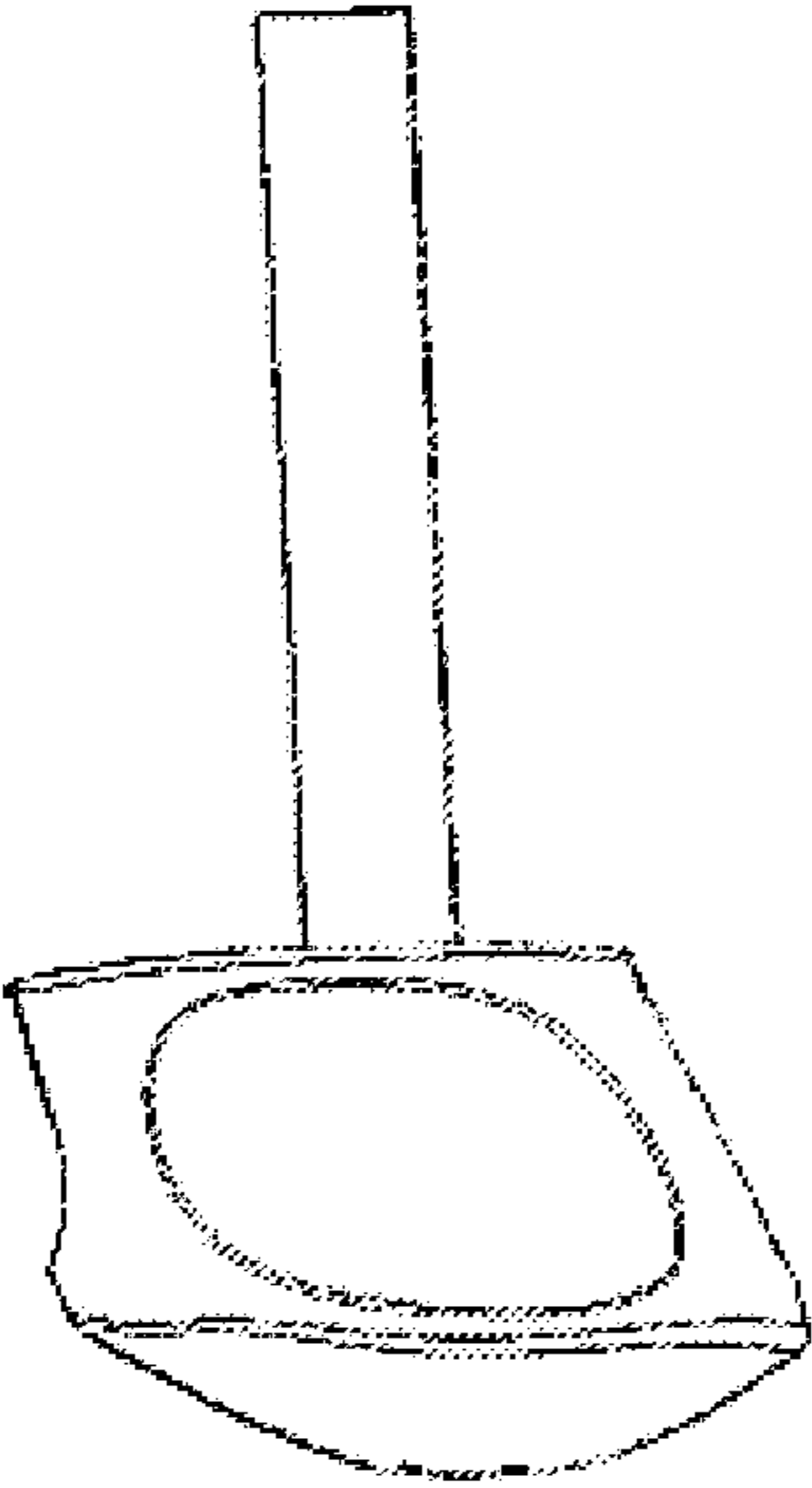

FIG. 12

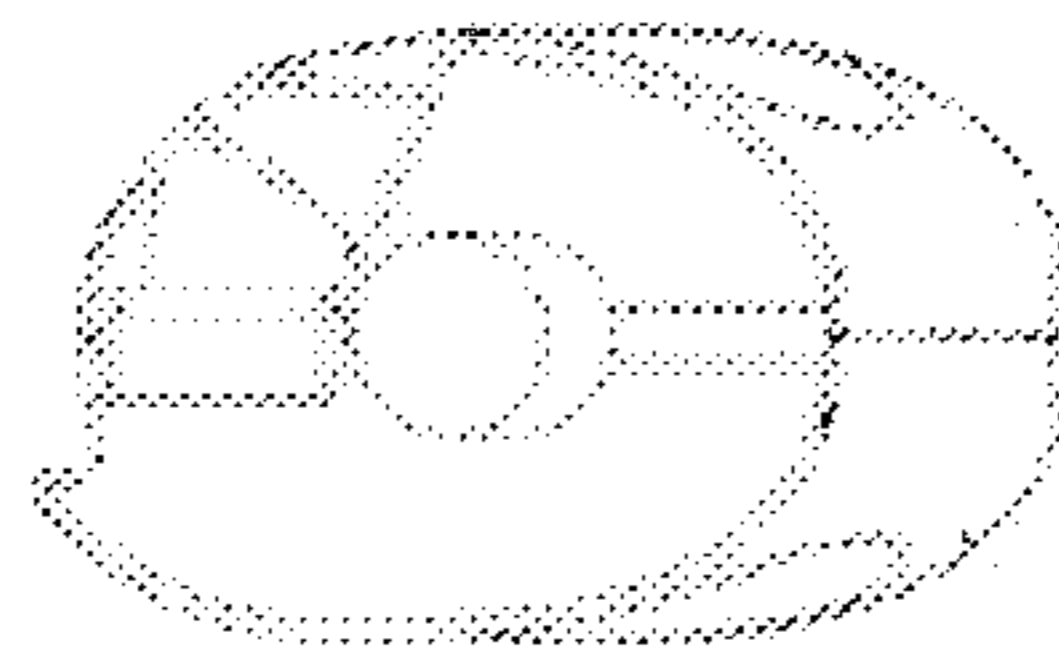

FIG. 13

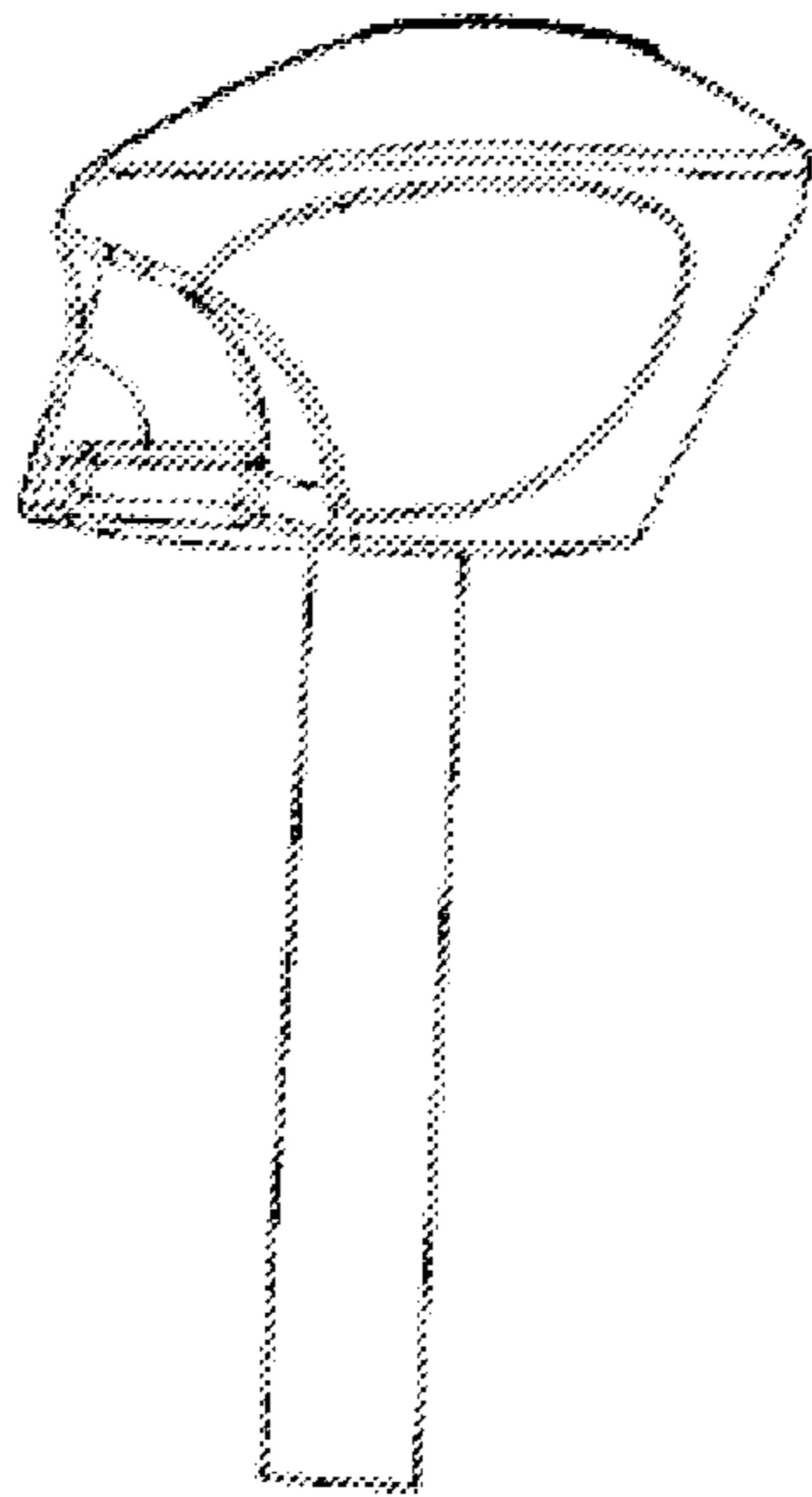

FIG. 14

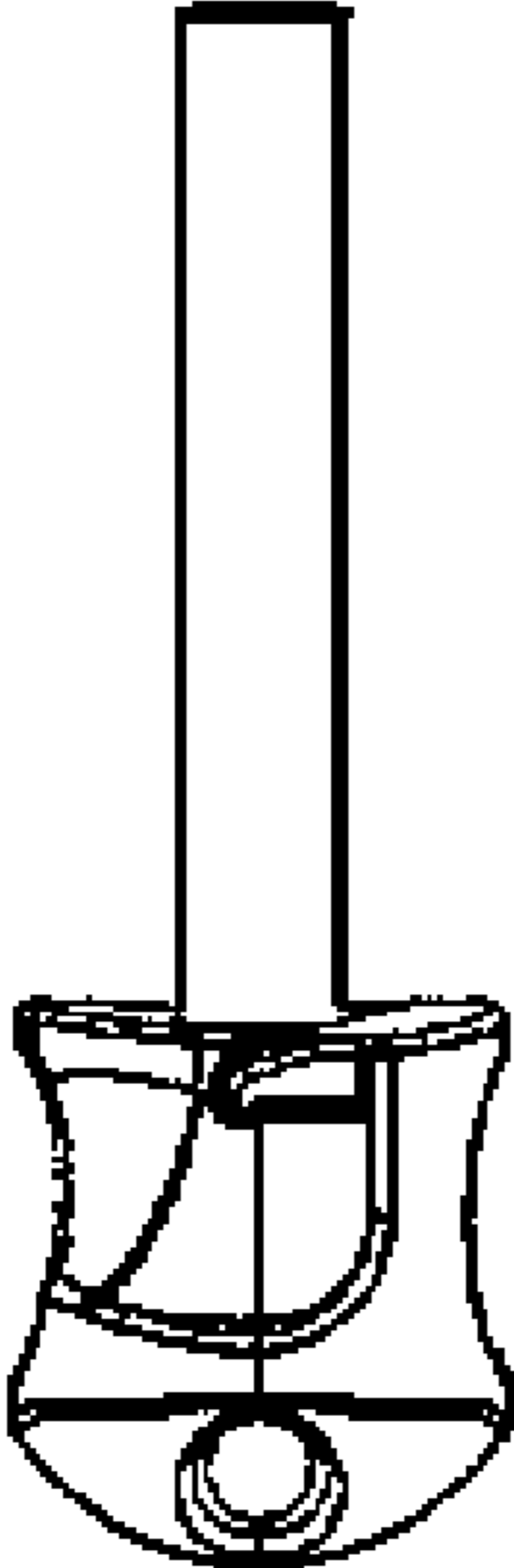

FIG. 15

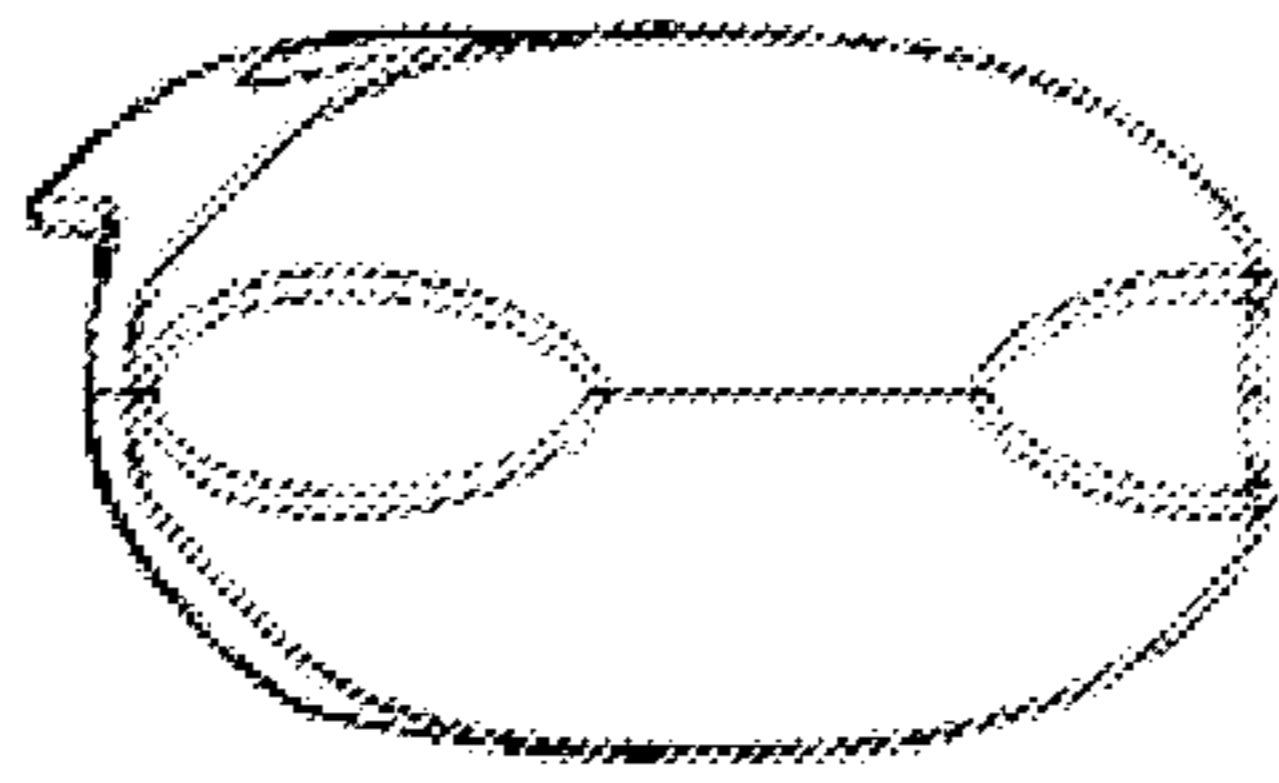

FIG. 16

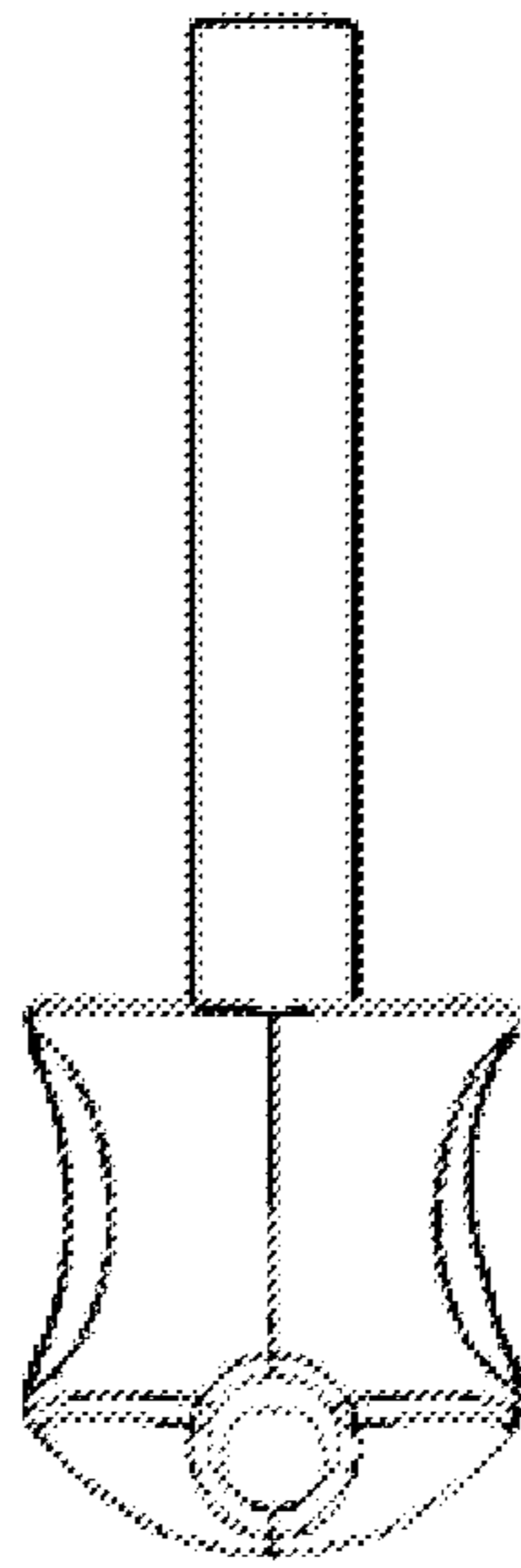

FIG. 17

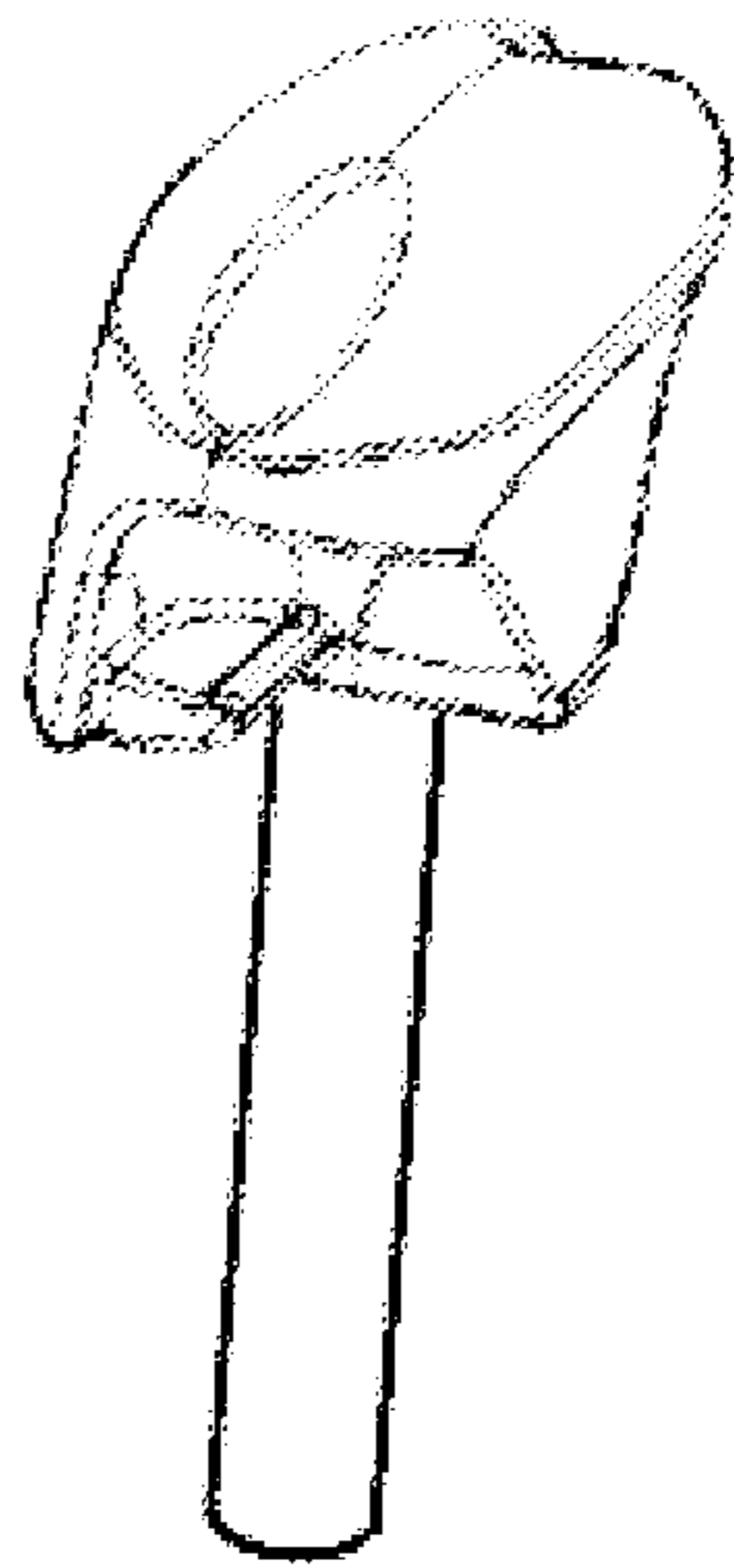

FIG. 18

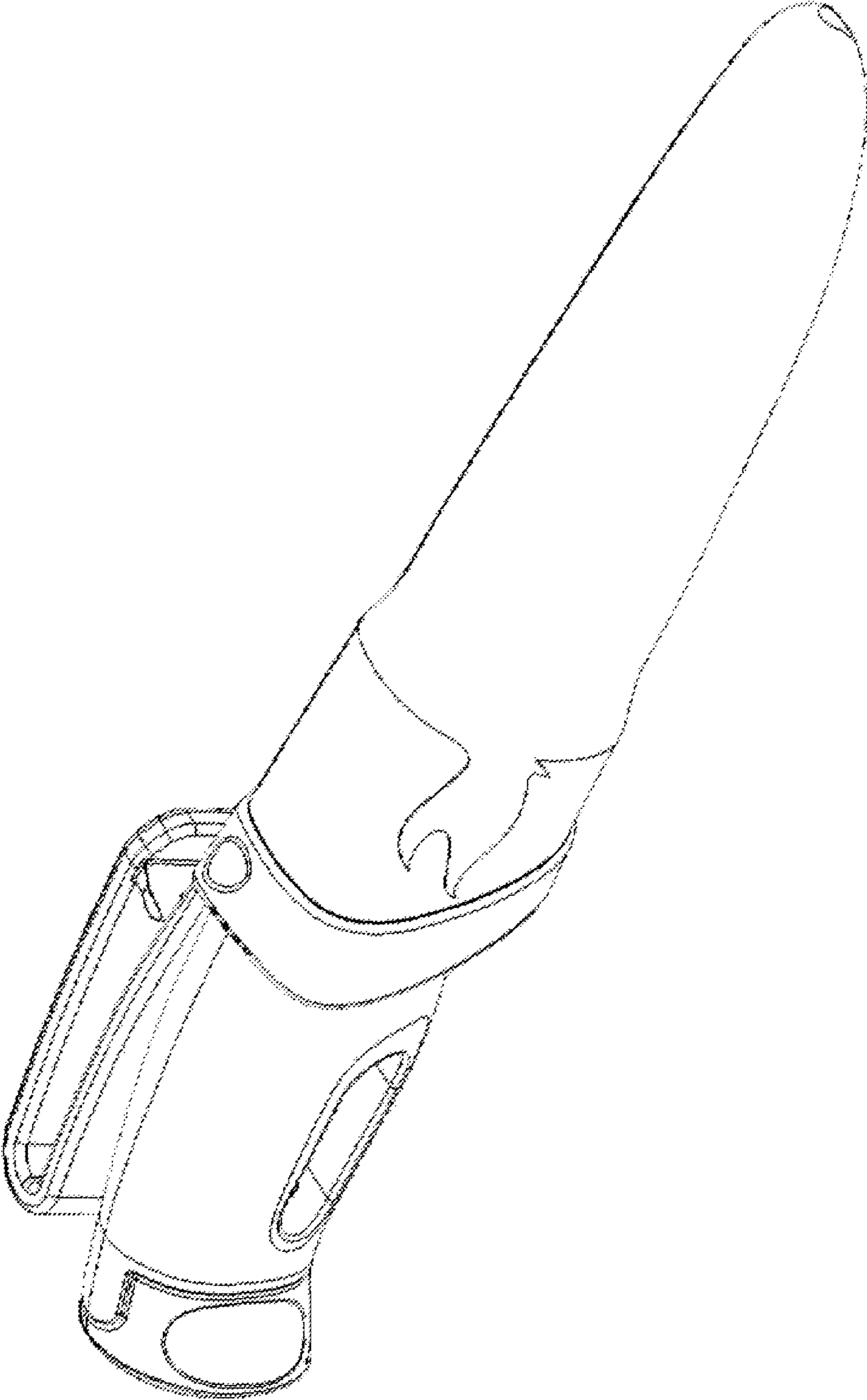

FIG. 19

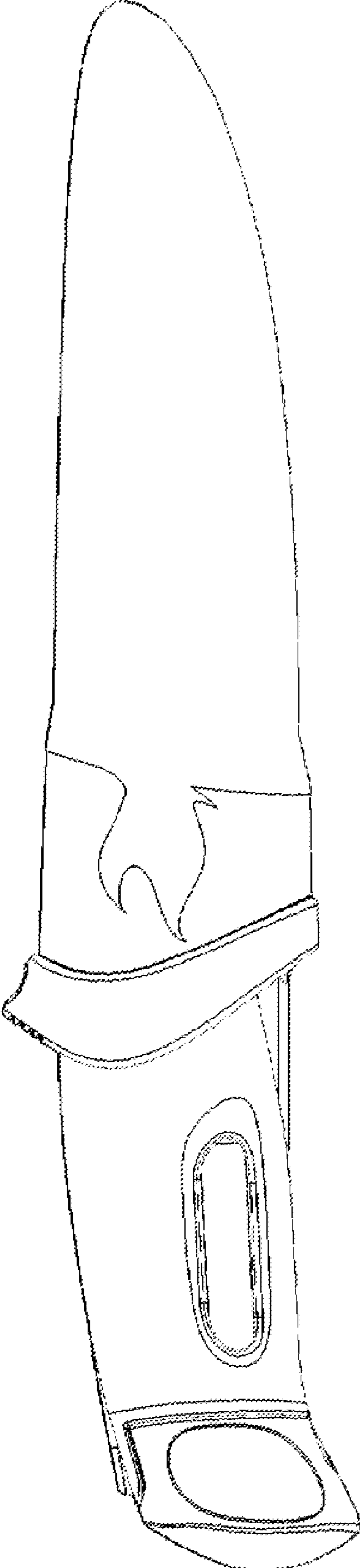

FIG. 20

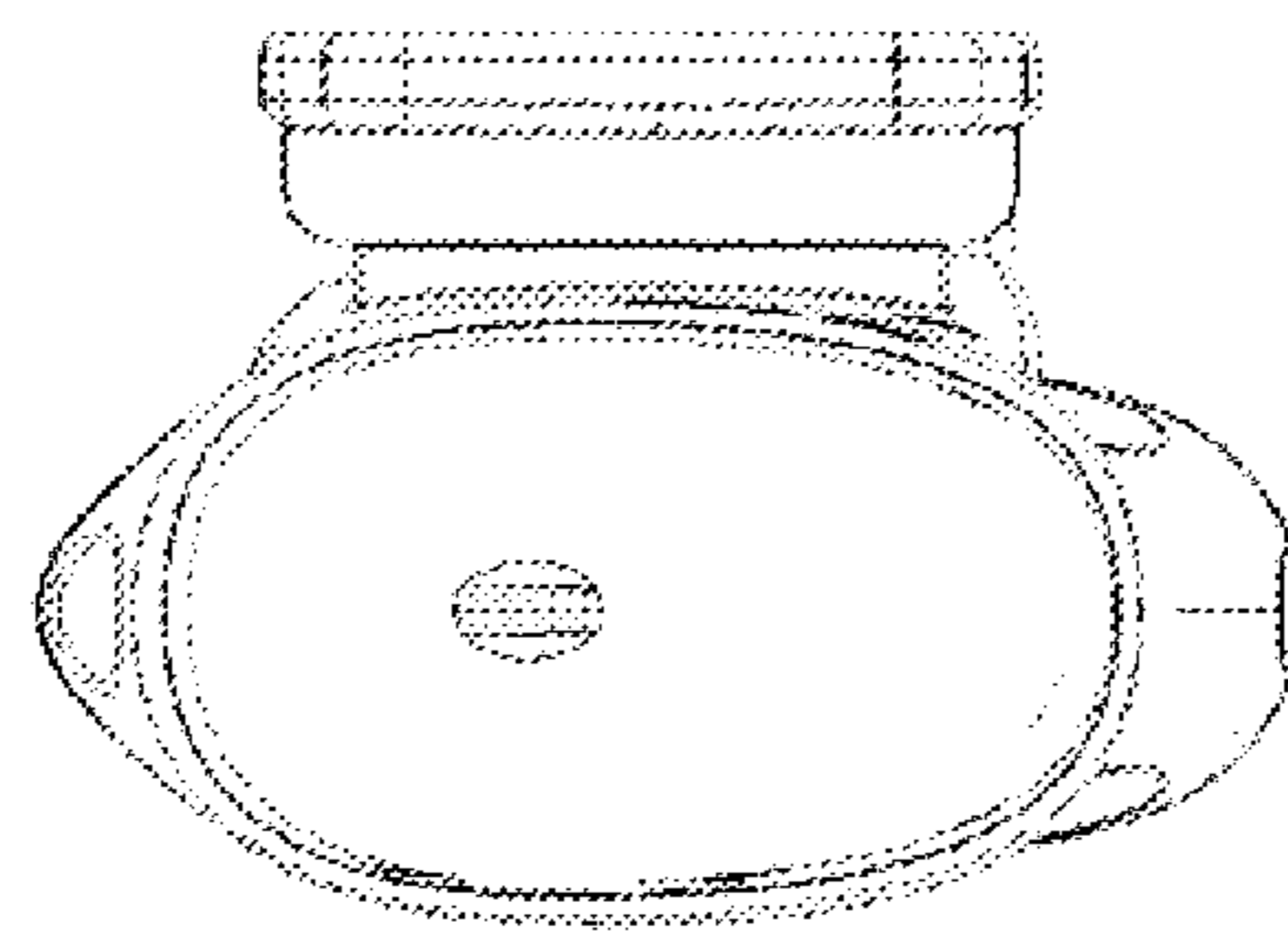

FIG. 21

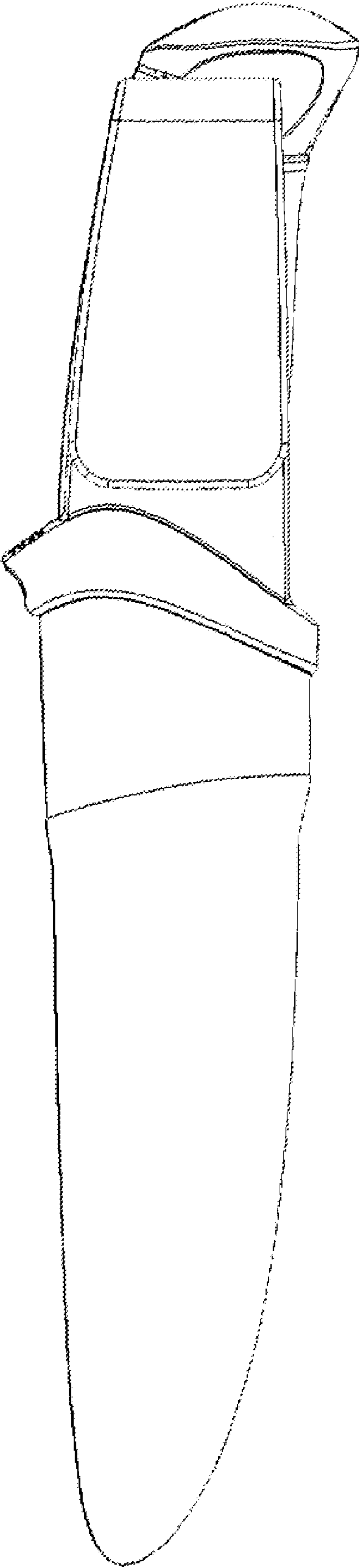

FIG. 22

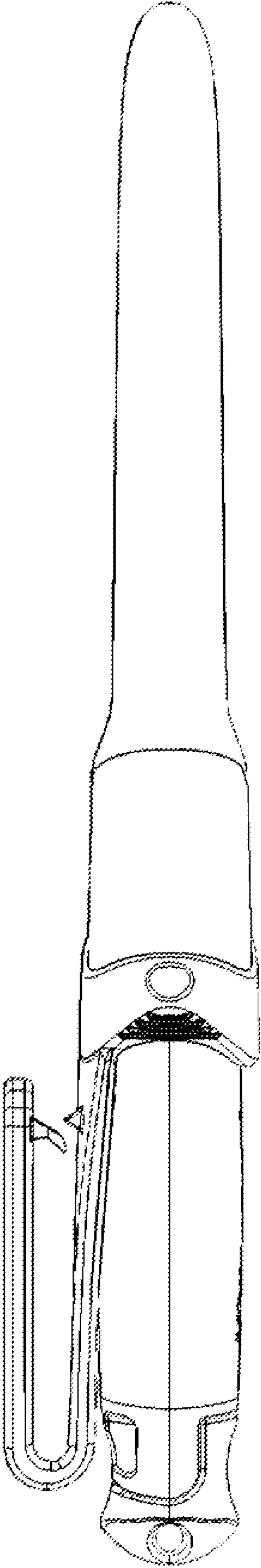

FIG. 23

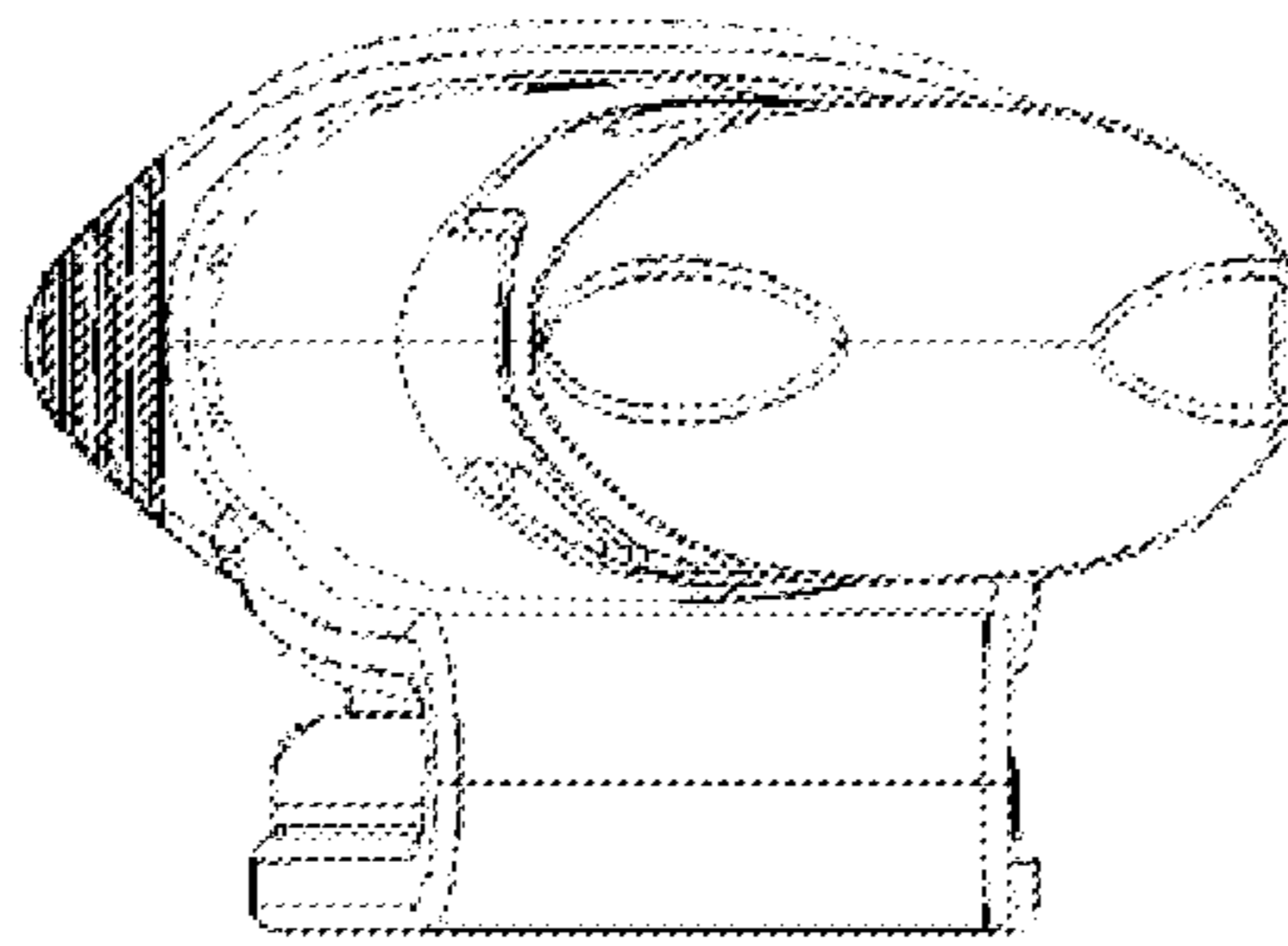

FIG. 24

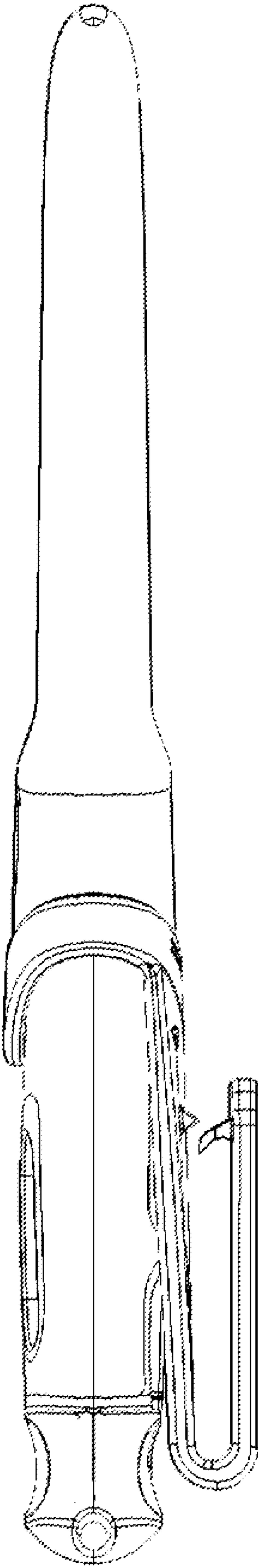

FIG. 25

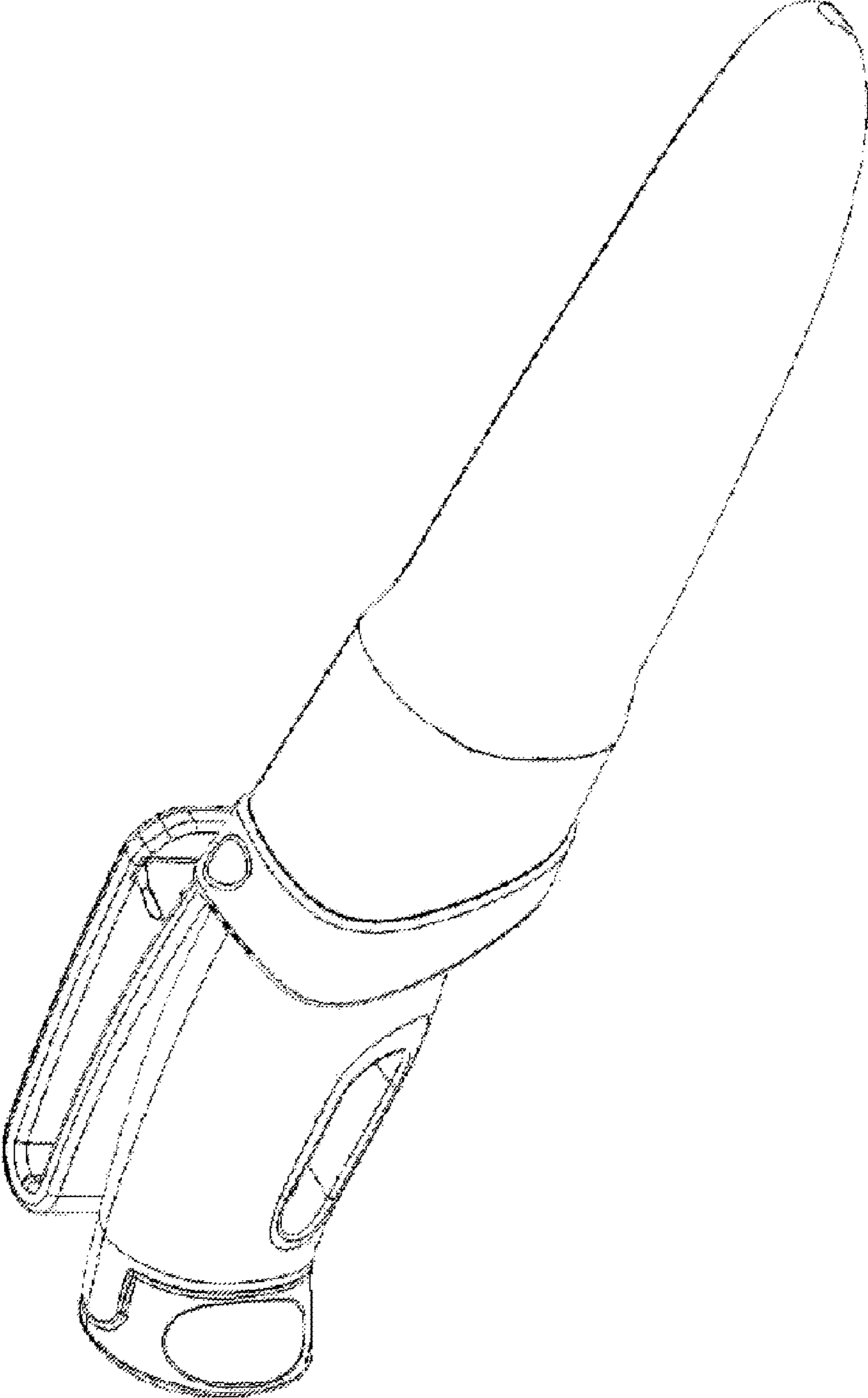

FIG. 26

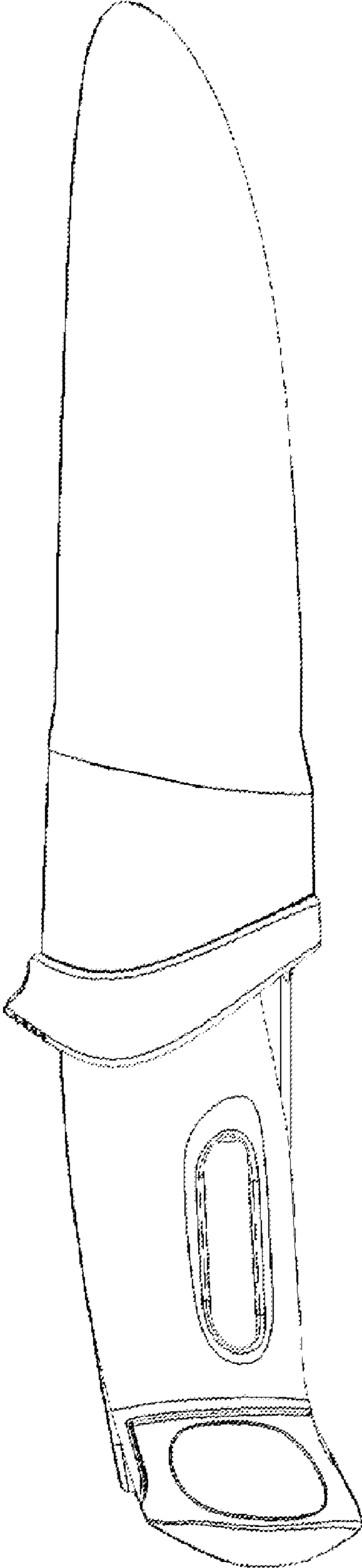

FIG. 27