

US00D699719S

(12) **United States Design Patent**
Akana et al.

(10) **Patent No.:** **US D699,719 S**

(45) **Date of Patent:** **** *Feb. 18, 2014**

(54) **PORTABLE DISPLAY DEVICE**

(71) Applicant: **Apple Inc.**, Cupertino, CA (US)

(72) Inventors: **Jody Akana**, San Francisco, CA (US);
Bartley K. Andre, Menlo Park, CA (US); **Jeremy Bataillou**, San Francisco, CA (US); **Daniel J. Coster**, San Francisco, CA (US); **Daniele De Iuliis**, San Francisco, CA (US); **M. Evans Hankey**, San Francisco, CA (US); **Julian Hoenig**, San Francisco, CA (US); **Richard P. Howarth**, San Francisco, CA (US); **Jonathan P. Ive**, San Francisco, CA (US); **Duncan Robert Kerr**, San Francisco, CA (US); **Shin Nishibori**, Kailua, HI (US); **Matthew Dean Rohrbach**, San Francisco, CA (US); **Peter Russell-Clarke**, San Francisco, CA (US); **Christopher J. Stringer**, Woodside, CA (US); **Eugene Antony Whang**, San Francisco, CA (US); **Rico Zörkendörfer**, San Francisco, CA (US)

(73) Assignee: **Apple Inc.**, Cupertino, CA (US)

(*) Notice: This patent is subject to a terminal disclaimer.

(**) Term: **14 Years**

(21) Appl. No.: **29/437,117**

(22) Filed: **Nov. 13, 2012**

Related U.S. Application Data

(63) Continuation of application No. 29/382,846, filed on Jan. 7, 2011, now Pat. No. Des. 670,692.

(51) **LOC (10) Cl.** **14-02**

(52) **U.S. Cl.**
USPC **D14/341**

(58) **Field of Classification Search**

USPC D14/341-347, 137, 138, 138.1, 138 AA, D14/138 R, 138 AB, 138 AD, 138 G, 138 A, D14/496, 426, 429, 129, 130, 420, 439-441, D14/448, 125, 147, 156, 218, 250, 389, 336, D14/203.1, 203.3, 203.4, 203.7, 315; D21/324, 329, 330; D10/65, 104; D18/6-7; 345/169, 901, 905, 156, 157, 345/168, 173; 361/814, 680, 686, 679.27, 361/679.3; 341/22; 348/168; 379/433.04, 379/433.07, 433.11, 916, 433.01, 433.06

See application file for complete search history.

(56) **References Cited**

U.S. PATENT DOCUMENTS

2,424,630 A	7/1947	Perez	
D262,151 S	12/1981	Sussman	
D265,326 S	7/1982	Sugiyama	
D270,061 S	8/1983	Ackeret	
D270,062 S	8/1983	Ackeret	
D270,063 S	8/1983	Ackeret	
D270,066 S	8/1983	Ackeret	
D278,276 S	4/1985	Bakic	
4,545,023 A	10/1985	Mizzi	
D284,084 S	6/1986	Ferrara, Jr.	
D289,873 S	5/1987	Gemmell et al.	
D306,583 S	3/1990	Krolopp et al.	
D308,055 S	5/1990	Tedham et al.	
D317,609 S	6/1991	Wei	
D321,215 S	10/1991	Shamis	
D332,328 S	1/1993	Lombardi, Jr.	
D333,574 S	3/1993	Ackeret	D6/300
D337,322 S	7/1993	Yang	
D337,569 S	7/1993	Kando	
D340,701 S	10/1993	Takeuchi	
D340,917 S	11/1993	Sakaguchi et al.	
D345,346 S	3/1994	Alfonso et al.	
D346,589 S	5/1994	Andros	
D346,793 S	5/1994	Iino et al.	
5,345,543 A	9/1994	Capps et al.	
5,347,295 A	9/1994	Agulnick et al.	
5,398,310 A	3/1995	Tchao et al.	
D361,552 S	8/1995	Iino	
5,463,725 A	10/1995	Henckel et al.	
5,488,204 A	1/1996	Mead et al.	
5,495,566 A	2/1996	Kwatinetz	
D395,639 S	6/1998	Ham et al.	
D396,215 S	7/1998	Inukai	

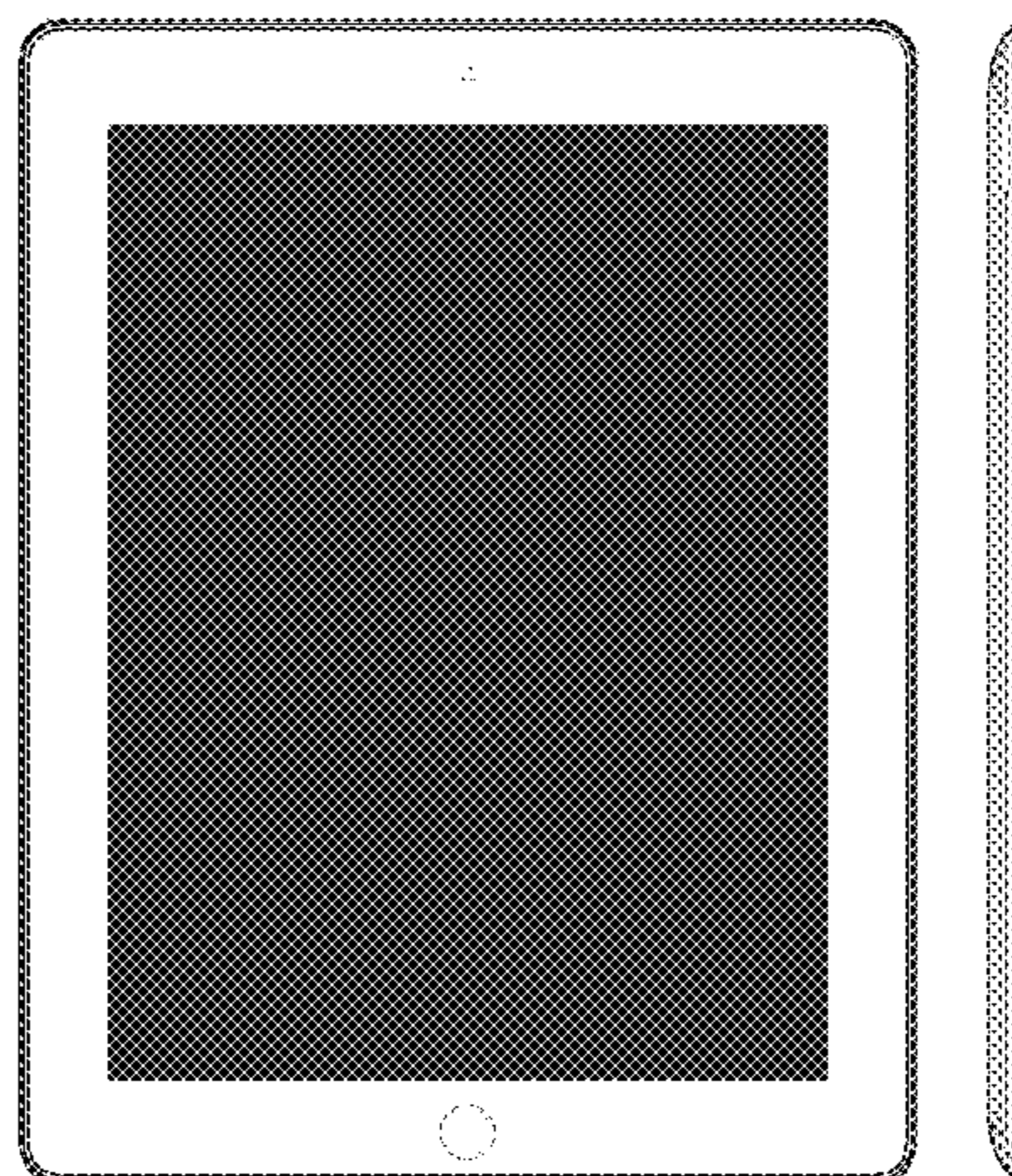

US D699,719 S

D396,452 S	7/1998	Naruki	D577,703 S	9/2008	Lee et al.	
D408,372 S	4/1999	Ota et al.	D579,930 S	11/2008	Maskatia	
D408,794 S	4/1999	Ogasawara	D580,387 S	11/2008	Andre et al.	
D409,185 S	5/1999	Kawashima	D580,431 S	11/2008	Morita	
D410,440 S	6/1999	Carnell	D581,922 S	12/2008	Andre et al.	
D412,157 S	7/1999	Stevenson	D583,346 S	12/2008	Jung et al.	
D420,354 S	2/2000	Morales	D583,373 S	12/2008	Chen	
D424,535 S	5/2000	Peltola	D584,711 S	1/2009	Kim et al.	
D425,887 S	5/2000	Edwards et al.	D584,738 S *	1/2009	Kim et al.	D14/496
6,061,063 A	5/2000	Wagner et al.	D586,800 S	2/2009	Andre et al.	
6,067,068 A	5/2000	Hussain	D587,260 S	2/2009	Marsh et al.	
D438,201 S	2/2001	Ogawa et al.	D587,267 S	2/2009	Wang	
D444,465 S	7/2001	Do	D592,211 S	5/2009	Ichise et al.	
D448,031 S	9/2001	Goetz	D592,212 S	5/2009	Hamada et al.	
D448,764 S	10/2001	Marsalka et al.	D593,059 S	5/2009	Kim et al.	
6,310,610 B1	10/2001	Beaton et al.	D594,863 S	6/2009	Ichise et al.	
D451,505 S	12/2001	Iseki et al.	D595,712 S	7/2009	Guery et al.	
D452,687 S	1/2002	Yeh	D597,067 S	7/2009	Oh et al.	
6,337,698 B1	1/2002	Keely, Jr. et al.	D598,016 S	8/2009	Han et al.	
D453,333 S	2/2002	Chen	D599,342 S	9/2009	Andre et al.	
D454,348 S	3/2002	Yeh	D600,241 S	9/2009	Andre et al.	
D455,433 S	4/2002	Alviar et al.	D600,690 S	9/2009	Miyaji	
D456,023 S	4/2002	Andre et al.	D601,353 S	10/2009	Sadler et al.	
D456,805 S	5/2002	Ono et al.	D601,558 S	10/2009	Andre et al.	
D457,530 S	5/2002	Amron	D602,014 S	10/2009	Andre et al.	
D458,252 S	6/2002	Palm et al.	D602,015 S	10/2009	Andre et al.	
D461,175 S	8/2002	Yokota	D602,016 S	10/2009	Andre et al.	
D461,802 S	8/2002	Tu	D602,017 S	10/2009	Andre et al.	
D466,096 S	11/2002	Takada	D602,486 S	10/2009	Andre et al.	
D466,501 S	12/2002	Hirota	D602,488 S	10/2009	Jiang et al.	
D467,890 S	12/2002	Lai et al.	D604,290 S	11/2009	Andre et al.	
6,501,967 B1	12/2002	Mäkelä et al.	D604,291 S	11/2009	Andre et al.	
D469,413 S	1/2003	To et al.	D604,292 S	11/2009	Andre et al.	
6,509,907 B1	1/2003	Kuwabara	D604,293 S	11/2009	Andre et al.	
D469,762 S	2/2003	Iwama et al.	D604,297 S	11/2009	Andre et al.	
D474,163 S	5/2003	Araki	D604,733 S	11/2009	Andre et al.	
D483,021 S	12/2003	Shih	D606,129 S	12/2009	Ben-Moshe	
D483,032 S	12/2003	Bertrand et al.	D606,988 S	12/2009	Andre et al.	
D483,359 S	12/2003	Lin et al.	D606,989 S	12/2009	Andre et al.	
D484,471 S	12/2003	Lin et al.	D606,991 S	12/2009	Liu et al.	
D485,265 S	1/2004	Sato et al.	D606,992 S	12/2009	Liu et al.	
D486,149 S	2/2004	Kawami et al.	D607,428 S	1/2010	Kim et al.	
6,690,387 B2	2/2004	Zimmerman et al.	D609,705 S	2/2010	Andre et al.	
D489,731 S	5/2004	Huang	7,658,675 B2	2/2010	Hotta	
D490,420 S	5/2004	Solomon et al.	D611,045 S	3/2010	Andre et al.	
D492,684 S	7/2004	Ozolins et al.	D611,469 S	3/2010	Andre et al.	
D496,040 S	9/2004	Jobs et al.	7,688,574 B2	3/2010	Zadesky et al.	
D496,362 S	9/2004	Ozolins et al.	D613,735 S	4/2010	Andre et al.	
D496,363 S	9/2004	Ozolins et al.	D613,736 S	4/2010	Andre et al.	
D497,364 S	10/2004	Ozolins et al.	D615,083 S	5/2010	Andre et al.	
6,822,635 B2	11/2004	Shahoian et al.	D616,436 S	5/2010	Busri	
D500,037 S	12/2004	Ozolins et al.	D617,793 S	6/2010	Chiang et al.	
D502,179 S	2/2005	Cha et al.	D619,555 S	7/2010	Yang et al.	
D502,944 S	3/2005	Kawami et al.	D620,004 S	7/2010	Andre et al.	
D504,889 S	5/2005	Andre et al.	D621,825 S	8/2010	Andre et al.	
D506,195 S	6/2005	Leveridge et al.	D622,270 S	8/2010	Andre et al.	
D514,558 S	2/2006	Nagel et al.	D622,514 S *	8/2010	Park et al.	D6/308
D514,568 S	2/2006	Huang et al.	D622,718 S	8/2010	Andre et al.	
D528,517 S	9/2006	Izumi	D622,719 S	8/2010	Andre et al.	
D532,791 S	11/2006	Kim	D622,720 S	8/2010	Andre et al.	
D534,516 S	1/2007	Lheem	D623,184 S	9/2010	Green et al.	
D534,517 S	1/2007	Cho et al.	D624,070 S	9/2010	Lee et al.	
D540,203 S	4/2007	Jeon	D624,071 S	9/2010	Dan	
D543,183 S	5/2007	Cho et al.	D624,072 S	9/2010	Andre et al.	
D543,979 S	6/2007	Lee	D624,074 S	9/2010	Green et al.	
D548,713 S	8/2007	Lee et al.	D624,536 S	9/2010	Andre et al.	
D548,747 S	8/2007	Andre et al.	D624,914 S	10/2010	Wang	
D556,211 S	11/2007	Howard	D625,307 S	10/2010	Cheng	
D557,259 S	12/2007	Hirsch	D625,928 S	10/2010	Lee et al.	
D558,756 S	1/2008	Andre et al.	D627,343 S	11/2010	Andre et al.	
D558,757 S	1/2008	Andre et al.	D627,777 S	11/2010	Akana et al.	
D558,758 S	1/2008	Andre et al.	D627,778 S	11/2010	Akana et al.	
D560,227 S	1/2008	Bennett et al.	D629,799 S	12/2010	Andre et al.	
D565,596 S	4/2008	Kim	D630,207 S	1/2011	Seong	
D567,819 S	4/2008	Devericks et al.	D630,630 S	1/2011	Andre et al.	
D572,023 S	7/2008	Park	D631,474 S	1/2011	Green et al.	
D572,694 S	7/2008	Park	7,869,206 B2	1/2011	Dabov et al.	
D573,143 S	7/2008	Park et al.	D632,688 S	2/2011	Seong	
D575,760 S	8/2008	Kim et al.	D633,091 S	2/2011	Andre et al.	

US D699,719 S

D633,092 S	2/2011	Andre et al.	EM	001133201-0001	5/2009
D633,908 S	3/2011	Akana et al.	EM	001143010-0005	7/2009
D634,319 S	3/2011	Andre et al.	EM	001178750-0001	11/2009
D634,742 S	3/2011	Andre et al.	EM	001677816-0002	4/2010
D635,540 S	4/2011	Kim et al.	EM	001694712-0001	4/2010
D635,952 S	4/2011	Park et al.	EM	001214290-0003	6/2010
D636,390 S	4/2011	Andre et al.	EM	001222905-0001	10/2010
D636,392 S	4/2011	Akana et al.	EM	001222905-0002	10/2010
D636,769 S	4/2011	Wood et al.	EM	001767435-0001	10/2010
D636,770 S	4/2011	Li	EM	001772252-0001	10/2010
D637,596 S	5/2011	Akana et al.	EM	001000152-0001	11/2010
D638,815 S	5/2011	Lee et al.	EM	001140115-0001	11/2010
D638,835 S	5/2011	Akana et al.	EM	001802315-0001	1/2011
D639,805 S	6/2011	Song et al.	EM	001280432-0001	5/2011
D640,663 S *	6/2011	Arnholt et al. D14/138 G	ES	I0147763	3/2001
D641,018 S *	7/2011	Lee et al. D14/341	ES	D0505712-01	4/2008
D642,563 S	8/2011	Akana et al.	ES	D05111177	11/2010
D644,218 S	8/2011	Akana et al.	FI	4897	7/1980
D645,017 S	9/2011	Kim et al.	FR	990052-001	5/1999
D645,435 S	9/2011	Kim et al.	FR	985598-001	10/2001
D645,835 S	9/2011	Lee et al.	FR	985598-002	10/2001
D646,249 S	10/2011	Kim et al.	FR	985598-003	10/2001
D646,252 S	10/2011	Kim et al.	FR	985598-004	10/2001
D677,658 S *	3/2013	Akana et al. D14/341	GB	1042780	12/1986
2003/0125079 A1	7/2003	Park et al.	GB	1058720	11/1989
2003/0125094 A1	7/2003	Hyun et al.	GB	1058721	11/1989
2003/0125959 A1	7/2003	Palmquist et al.	GB	2030050	10/1992
2003/0184525 A1	10/2003	Tsai	GB	2033245	8/1993
2003/0206202 A1	11/2003	Moriya	GB	2101448	10/2000
2004/0021676 A1	2/2004	Chen et al.	GB	2103809	2/2001
2004/0041504 A1	3/2004	Ozolins et al.	GB	3009998	1/2003
2005/0156902 A1	7/2005	McPherson et al.	GB	3010002	1/2003
2009/0067141 A1	3/2009	Dabov et al.	GB	3014024	8/2003
2011/0151945 A1	6/2011	Jiang et al.	GB	3022447	10/2005
(Continued)			JP	61-69284	4/1986
			JP	4-370868	12/1992
			JP	886431	12/1993
			JP	887388	12/1993
			JP	6-102341	4/1994
			JP	000921403	3/1995
			JP	949744	3/1996
			JP	953136	5/1996
			JP	9-325180	12/1997
			JP	001009317	5/1998
			JP	11-112918	4/1999
			JP	11-126149	5/1999
			JP	D1098145	1/2001
			JP	001104685	3/2001
			JP	D1124750	10/2001
			JP	D1133939	2/2002
			JP	001142127	5/2002
			JP	D1143615	6/2002
			JP	D1145748	7/2002
			JP	2002-254614	9/2002
			JP	D1155176	10/2002
			JP	D1159881	12/2002
			JP	D1178470	7/2003
			JP	001188041	10/2003
			JP	2003-330613	11/2003
			JP	D1194485	1/2004
			JP	D1204221	5/2004
			JP	2004-290256	10/2004
			JP	001235888	4/2005
			JP	001241638	6/2005
			JP	D1241383	6/2005
			JP	D1247215	8/2005
			JP	D1250487	9/2005
			JP	D1263649	2/2006
			JP	001280315	9/2006
			JP	D1285057	10/2006
			JP	D1295003	2/2007
			JP	D1302929	6/2007
			JP	D1325539	3/2008
			JP	001351273	2/2009
			JP	D141798	8/2011
			KR	30-0037851	8/1982
			KR	30-0109896	11/1990
			KR	30-0110034	11/1990
			KR	30-0213519	4/1998

FOREIGN PATENT DOCUMENTS

AU	315078	7/2007			
CA	72548	5/1993			
CA	89155	3/2000			
CA	101263	1/2004			
CN	3455506D	6/2005			
CN	1695105 A	11/2005			
CN	3675965D	8/2007			
CN	300724841D	12/2007			
CN	300759405D	3/2008			
CN	300795426D	6/2008			
CN	301129338D	2/2010			
CN	301216430 S	5/2010			
CN	301254028 S	6/2010			
DE	40104198-0001	9/2001			
DE	40301867-0001	9/2003			
DE	40705936-0001	5/2008			
EM	00048061-0001	8/2003			
EM	000046198-0001	11/2003			
EM	000181607-0001	8/2004			
EM	000317490-0001	5/2005			
EM	000328265-0001	6/2005			
EM	000257621-0004	7/2005			
EM	000375191-0001	9/2005			
EM	000401898-0003	11/2005			
EM	000493721-0002	5/2006			
EM	000569157-0005	9/2006			
EM	000614565-0001	12/2006			
EM	00066789-0001	3/2007			
EM	000718770-0007	6/2007			
EM	000748280-0001	8/2007			
EM	000748280-0006	8/2007			
EM	000767959-0001	8/2007			
EM	000748314-0001	10/2007			
EM	000891809-0003	4/2008			
EM	000939731-0001	6/2008			
EM	000977822-0006	7/2008			
EM	001000152-0001	9/2008			
EM	001052377-0001	12/2008			
EM	001005839-0007	3/2009			
EM	001098149-0001	4/2009			
EM	001098149-0005	4/2009			

KR	30-0222985-1	2/1999
KR	30-0237641	6/1999
KR	30-0241312	7/1999
KR	30-0288858	1/2002
KR	30-0290725	1/2002
KR	30-0291915	2/2002
KR	30-0294002	3/2002
KR	30-0296928	5/2002
KR	30-0297741	5/2002
KR	30-0304213	8/2002
KR	30-0307008	9/2002
KR	30-0307235	9/2002
KR	30-0307307	9/2002
KR	30-0309692	10/2002
KR	30-0312151	11/2002
KR	30-0312152	11/2002
KR	30-0327126	6/2003
KR	30-0330831	8/2003
KR	30-0332851	9/2003
KR	30-0336260	10/2003
KR	30-0338781	11/2003
KR	2003-0088374	11/2003
KR	30-0338886	12/2003
KR	30-0326632-2	1/2004
KR	30-0398307	11/2005
KR	30-0394921-1	12/2005
KR	30-0418422-1	7/2006
KR	30-0418547	7/2006
KR	30-0422222	8/2006
KR	30-0424148	9/2006
KR	30-0441230	2/2007
KR	30-0452432	6/2007
KR	30-0452985	8/2007
KR	30-0529167	5/2009
KR	30-0533504	7/2009
KR	30-0546031	11/2009
KR	301499241 S	3/2011
KR	30-0598018	5/2011
KR	30-0598021	5/2011
NO	082652	11/2010
PA	D1155168	10/2002
SE	55044	10/1993
SE	2001/0343	9/2002
TW	584453	4/2004
TW	D106137	8/2005
TW	D126998	1/2009
TW	D137754 S1	11/2010
TW	D141798	8/2011
WO	WO 00/74240 A1	12/2000
WO	WO 01/88679	11/2001
WO	WO 2004/023272 A2	3/2004

OTHER PUBLICATIONS

“A Day in the Life of InfoLink,” Stanford University Libraries, published May 1, 2003.

“The Oracle: The Personal Computer of the Year 2000,” Stanford University Libraries.

“The Organizer: The Personal Computer of the Year 2000,” Stanford University Libraries.

Akihabara News Team, “Electricpig Gets Hands On Hannspad Android Tablet,” (<http://en.akihabaranews.com/73543/tablet-pda/electricpig-gets-hands-on-hannspad-android-tablet/>), published Nov. 22, 2010, 1 page.

Aliexpress.com, “WACOM PL-500 15" LCD Tablet Mint,” (<http://www.aliexpress.com/product-fm/430172068-WACOM-PL-500-15-LCD-Tablet-Mint-Worldwide-Free-Shipping-wholesalers.html>), accessed Nov. 14, 2011, 3 pages.

Allan, “Hannspad Android tablet: photos and video,” Electricpig.co.uk, (<http://www.electricpig.co.uk/2010/11/18/hannspad-android-tablet-photos-and-video/>), published Nov. 18, 2010, 6 pages.

Amazon.com, “Digitalway MPIO FL100 128 MB MP3 Player” (<http://www.amazon.com/Digitalway-MPIO-FL100-128-Player/dp/B00008V6NI>), accessed Nov. 17, 2011, 7 pages.

Amazon.com, “Whirlpool Gold : GH7208XRS 2.0 cu. ft. Velos Speedcook Over the Range Microwave Oven,” (<http://www.amazon.com/Whirlpool-Gold-GH7208XRS-Speedcook-Microwave/dp/B000ZIPHM8>), accessed May 23, 2012, 5 pages.

AndroidTabletFanatic.com “16 Old-Skool Tablets Rocking it Before the iPad,” (<http://www.androidtabletfanatic.com/android-tablet-news/16-old-skool-tablets-rocking-it-before-the-ipad/>), published May 16, 2011, 10 pages.

ASUS Computer Inc., “ASUS Tablet Computers—Providing Choice through Innovation at CES 2011,” (<http://milandesignweek2011.asus.com/archives/ces-2011/asus-tablet-computers-providing-choice-through-innovation-at-ces-2011/>), published Jan. 4, 2011, 4 pages.

Blanford, “Nokia N92 Preview,” (http://www.allaboutsymbian.com/features/item/Nokia_N92_Preview.php), published Nov. 23, 2005, 10 pages.

Block, “Olympus @ CES Hands-on with the m:robe MR-500i and MR-100,” Engadget.com, (<http://www.engadget.com/2005/01/10/olympus-ces-hands-on-with-the-m-robe-mr-500i-and-mr-100/>), published Jan. 10, 2005, 3 pages.

Block, “Philips PET830 and PET1030 media players,” Engadget, (<http://www.engadget.com/2006/11/29/philips-pet830-and-pet1030-media-players/>), published Nov. 29, 2006, 2 pages.

Boggs, “Electrovaya Scribbler SC4000 Review,” Tablet PC Review, (<http://www.tabletpcreview.com/default.asp?newsID-1130>), published Apr. 15, 2008, 6 pages.

Cell Phones.About.com, “More pictures of the LG KG800,” (http://cellphones.about.com/library/bl-pi-lg_kg800.htm), accessed Feb. 13, 2012, 1 page.

Clarke, “Newspad by Authur C. Clarke from 2001: A Space Odyssey,” (<http://www.technovelgy.com/ct/content.asp?Bnum=529>), published 1968, 3 pages.

ComputerWeekly.com, “Why the Blackberry Playbook is for enterprise users,” (<http://www.computerweekly.com/news/1280097215/Why-the-Blackberry-Playbook-is-for-enterprise-users>), published Sep. 28, 2010, 1 page.

Computex.biz, “Tatung Tablet PC,” (http://www.computex.biz/tatung/Default.aspx?pagetype=ProductDetail&pdt_id=36&cid=3...), accessed Nov. 4, 2011, 3 pages.

Electricpig, “IFA 2010: Toshiba booth tour—Folio 100, Jacob Jensen and a few extra treats,” Electricpig.co.uk, (<http://www.electricpig.co.uk/2010/09/03/ifa-2010-toshiba-booth-tour-folio-100-jacob-jensen-and-a-few-extra-treats/ifa-2010-toshiba-booth-tour-8/>), published Sep. 3, 2010, 1 page.

Fidler, “Mediarmorphosis: Understanding New Media,” pp. 220, 222-225, and 236-242, Pine Forge Press, Thousand Oaks, CA (1997). Fidler, “Predicting e-readers in 1981: A look back at the future,” Associated Press Managing Editors, (<http://www.snd.org/2010/01/predicting-e-readers-in-1981-a-look-back-at-the-future/>) published Jan. 14, 2010, 5 pages.

Flatley, “BoEye MID700 unveiled with Android OS, vaguely familiar form factor,” Engadget.com, (http://engadget.com/2009/11/11/boeye-mid700-unveiled-with-android-os-vaguely-familiar-form-fac/?icid=eng_Dubai_art), published Nov. 11, 2009, 2 pages.

Flickr.com, “Apple Graphics Tablet” (http://farm3.static.flickr.com/2691/4126733086_b24c987b0e_o.jpg), accessed Nov. 15, 2011, 1 page.

Fried, “Live-blogging Steve Ballmer,” CNET, (http://www.cnet.com/8301-31045_1-10426723-269.html?tag=mncol%3btxt), published Jan. 6, 2010, 6 pages.

Ganapati, “Hands On With the JooJoo, Formerly Known as CrunchPad,” (<http://www.wired.com/gadgetlab/2009/12/hands-on-joo-joo-crunchpad/all/1>), published Dec. 7, 2009, 3 pages.

Goss, “ViewSonic ViewPad 100 with Windows and Android shown,” TechRadar.com, (<http://www.techradar.com/news/mobile-computing/viewsonic-viewpad-100-with-windows-and-android-shown-714182>), published Sep. 3, 2010, 2 pages.

Grabham, “Hands on: Toshiba Folio 100 review,” TechRadar.com, (<http://www.techradar.com/news/mobile-computing/tablets/hands-on-toshiba-folio-100-review-714014>), published Sep. 2, 2010, 4 pages.

Grabham, “Hands on: Viewsonic ViewPad 10 review,” TechRadar.com, (<http://www.techradar.com/news/mobile-computing/tablets/hands-on-viewsonic-viewpad-10-review-714205>), published Sep. 3, 2010, 3 pages.

- Henderson, "LG Optimus Pad to take on Samsung and Apple," Pocket-lint.com, (<http://www.pocket-lint.com/news/35287/lg-optimus-pad-samsung-apple>), published Aug. 31, 2010, 1 page.
- Itbusiness.ca, "Microsoft Mira eHome Wireless Smart Display," (http://www.itbusiness.ca/images/articles/Jun10/clip_image003_0087.jpg), accessed Nov. 15, 2011, 1 page.
- iTechNews.net, "Samsung K3 MP3 Player," (<http://www.itechnews.net/2006/12/02/samsung-k3-mp3-player/>), published Dec. 2, 2006, 9 pages.
- JKKMobile.com, "Hanvon TouchPad BC10C tablet review," (<http://www.ikkmobile.com/2010/03/hanvon-touchpad-bc10c-tablet-review.html>), published Mar. 13, 2010, 2 pages.
- Justia, "Apple v. Samsung Electronics Co. Ltd. et al., Filing: 166 Attachment: 2," (<http://docs.justia.com/cases/federal/district-courts/california/candce/5:2011cv01846/239768/166/2.html>), dated Aug. 22, 2011.
- Justia, "Apple v. Samsung Electronics Co. Ltd. et al., Filing: 166 Attachment: 3," (<http://docs.justia.com/cases/federal/district-courts/california/candce/5:2011cv01846/239768/166/3.html>), dated Aug. 22, 2011.
- Justia, "Apple v. Samsung Electronics Co. Ltd. et al., Filing: 166 Attachment: 4," (<http://docs.justia.com/cases/federal/district-courts/california/candce/5:2011cv01846/239768/166/4.html>), dated Aug. 22, 2011.
- Justia, "Apple v. Samsung Electronics Co. Ltd. et al., Filing: 943 Attachment: 5," (<http://docs.justia.com/cases/federal/district-courts/california/candce/5:2011cv01846/239768/943/5.html>), dated May 18, 2012, 2 pages.
- Knowyourmobile.com, "LG KG800 technical specifications," (http://www.knowyourmobile.com/lg/lgkg800chocolate/lgkg800reviews/137/lg_kg800_technical_specifications.html), published Mar. 9, 2007, 3 pages.
- Leachon, "IFA 2010: Toshiba's Folio 100 Tablet has Android, Flash and nice price tag," ShinyShiny.tv, (http://www.shinyshiny.tv/2010/09/ifa_2010_toshiba_folio_100.html), published Sep. 2, 2010, 2 pages.
- McCracken, "The iPad. Of 2000. As Envisioned in 1988," Technologizer.com, (<http://technologizer.com/2010/05/14/the-ipad-of-2000-as-envisioned-in-1988/>), published May 14, 2010, 12 pages.
- Mel et al., "Tablet: Personal Computer in the Year 2000," *Communications of the ACM* 31:638-646, ACM (Jun. 1988).
- Miles, "56 Apple iPad concept designs: Could any be real?," (<http://www.pocket-lint.com/news/26500/56-apple-ipad-concept-designs>), published Aug. 21, 2009, 14 pages.
- Miles, "BlackBerry PlayBook: RIM launches tablet," Pocket-lint.com, (<http://www.pocket-lint.com/news/35893/rim-blackberry-playbook-tablet-device>), published Sep. 27, 2010, 8 pages.
- Miller, "MSI shows off 10-inch Android tablet running new Tegra chipset," Engadget.com, (<http://www.engadget.com/2010/01/08/msi-shows-off-10-inch-android-tablet-running-new-tegra-chipset/>), published Jan. 8, 2010, 11 pages.
- Mobilegazette.com, "Nokia N92," (<http://www.mobilegazette.com/nokia-n92-051102.htm>), published Nov. 2, 2005, 2 pages.
- Needleman, "Hands-on with the JooJoo," (http://news.cnet.com/8301-19882_3-10410960-250.html), CNET News, published Dec. 7, 2009, 31 pages.
- Newlaunches.com, "Pidion BM-200 sleek Windows CE PDA phone from Bluebird," (http://www.newlaunches.com/archives/pidion_bm200_sleek_windows_ce_pda_phone_from_bluebird.php), published Dec. 15, 2005, 3 pages.
- Nguyen, "Hannspree's Hannspad Tablet Runs Android 2.2 with Custom UI," Ubergizmo.com, (<http://www.ubergizmo.com/2010/11/hannspree-hannspad-tablet-runs-android-2-2-with-custom-ui/>), published Nov. 18, 2010, 1 page.
- NYTimes.com, "iRiver U10 (1GB)," (<http://www.nytimes.com/technology/personaltech/music-players/iRiver-U10-1GB-31432102.html>), published Feb. 12, 2012, 2 pages.
- Patel, "The HP Slate" (<http://www.engadget.com/2010/01/06/the-hp-slate/>), Engadget.com, published Jan. 6, 2010, 4 pages.
- PDADB.net, "Acer n20 Specs," (<http://pdadb.net/index.php?m=specs&id=257&c=acern20>), published May 13, 2005, 3 pages.
- PDADB.net, "Casio Cassiopeia IT-10 M20BR Specs," (http://pdadb.net/index.php?m=specs&id=95&c=casio_cassiopeia_it-10_m20br), published Dec. 30, 2004, 3 pages.
- PDADB.net, "Dell Axim X3 Basic Specs," (http://pdadb.net/index.php?m=specs&id=81&c=dell_axim_x3_basic), published Dec. 30, 2004, 3 pages.
- PDADB.net, "MiTAC Mio 338 Plus Digi-Walker Specs," (http://pdadb.net/index.php?m=specs&id=60&c=mitac_mio_338_plus_digi-walker), published Dec. 25, 2004, 3 pages.
- PDADB.net, "O2 XDA (HTC Wallaby) Specs," (http://pdadb.net/index.php?m=specs&id=117&c=o2_xda_htc_wallaby), published Feb. 3, 2005, 3 pages.
- PDADB.net, "Sony Clie PEG-SL10 / PEG-SL10U / PEG-SL10E Specs," (http://pdadb.net/index.php?m=specs&id=1198&c=sony_clie_peg-sl10_peg-sl10u_peg-sl10e), published Mar. 4, 2008, 3 pages.
- PDADB.net, "Sony Clie PEG-T665C / PEG-T675C Specs," (http://pdadb.net/index.php?m=specs&id=1192&c=sony_clie_peg-t665c_peg-t675c), published Mar. 4, 2008, 3 pages.
- PDADB.net, "Toshiba Genio e330 Specs," (http://pdadb.net/index.php?m=specs&id=29&c=toshiba_genio_e330), published Dec. 9, 2004, 3 pages.
- PDADB.net, "Toshiba Genio e570 Specs," (http://pdadb.net/index.php?m=specs&id=229&c=toshiba_genio_e570), published May 4, 2006, 3 pages.
- Perton, "Samsung digital picture frame stores pics, movies, music," Engadget, (<http://www.engadget.com/2006/03/09/samsung-digital-picture-frame-stores-pics-movies-music/>), published Mar. 9, 2006, 1 page.
- Ricker, "LG's KE850 Prada official: iPhone says, wha?," Engadget.com, (<http://www.engadget.com/2007/01/18/lgs-ke850-prada-official-iphone-says-wha/>), published Jan. 18, 2007, 4 pages.
- Ricker, "The Pidion BM-200: it's time to move to Seoul," (<http://www.engadget.com/2005/10/04/the-pidion-bm-200-its-time-to-move-to-seoul/>), Engadget.com, published Oct. 4, 2005, 4 pages.
- Rojas, "Hands-on with the Nokia N92," Engadget.com, (<http://www.engadget.com/2005/12/01/hands-on-with-the-nokia-n92/>), published Dec. 1, 2005, 4 pages.
- S. Dimitris, "Pidion BM200 Smartphone," PDASNews, (www.pdasnews.com/articles/pidion-bm200-smartphone.html), accessed Mar. 7, 2012, 2 pages.
- Salestores.com, "LG L1530TM Tablet LCD Monitor," (<http://salestores.com/lgl1530tm.html>), accessed Nov. 17, 2011, 2 pages.
- Savov, "LG Pad coming in Q1 2011, with Android Honeycomb, dual-core Tegra 2, and 8.9-inch screen," Engadget.com, (<http://www.engadget.com/2010/11/03/lg-pad-coming-in-early-2011-with-android-honeycomb-dual-core-t/>), published Nov. 3, 2010, 1 page.
- Scott, "LG Announces LG Optimus Pad at Dealer Days in Brussels," Netbooknews.com, (<http://www.netbooknews.com/7518/lg-announces-lg-optimus-pad-at-dealer-days-in-brussels/>), published Aug. 31, 2010, 4 pages.
- Scott, "Motorola Xoom Android 3.0 Tablet Goes Official," Netbooknews.com, (<http://www.netbooknews.com/17229/motorola-xoom-android-3-0-tablet-goes-official/>), published Jan. 6, 2011, 6 pages.
- Stevens, "ICD confirms Vega tablet, includes Android 2.0, Tegra processor, our hearts," Engadget.com, (<http://www.engadget.com/2009/11/13/icd-confirms-vega-tablet-includes-android-2-0-tegra-processor/>), published Nov. 13, 2009, 2 pages.
- Sung, "Motorola Xoom vs Apple iPad," Pocket-lint.com, (<http://www.pocket-lint.com/news/37732/motorola-xoom-vs-apple-ipad/>), published Jan. 6, 2011, 3 pages.
- TechLahore.com, "China's Boeye releases 'Apple tablet' before Apple can—TechLahore@GITEX," (<http://www.techlahore.com/2009/11/08/chinas-boeye-releases-apple-tablet-before-apple-can-techlahoregitex/>), published Nov. 8, 2009, 3 pages.
- The Apple Collection, "Apple PowerPad G3 Pro—Apple Design & Prototype," (www.theapplecollection.com/design/macdesign/Apple_PowerPad_G3_Pro.shtml), updated Oct. 31, 2011, 2 pages.
- The Apple Collection, "MyPal," (www.theapplecollection.com/design/macdesign/MyPal.shtml), updated Oct. 31, 2011, 2 pages.

- The Apple Collection, "PowerPad," (www.theapplecollection.com/design/macdesign/PowerPad2.shtml), updated Oct. 31, 2011, 2 pages.
- Tingle, "ICD Vega Android 2.0 Tablet Available in 2010 [Vega Android Tablet, Nvidia Tegra Chipset Touting 'Low Cost Tablet' Confirmed]," (<http://nexus404.com/Blog/2009/11/13/icd-vega-android-2-0-tablet-available-in-2010-vega-android-tablet-nvidia-tegra-chipset-touting-low-cost-tablet-confirmed/>), TFTS published Nov. 13, 2009, 2 pages.
- To "Boeye MID 700 tablet runs Android with Apple-esque aesthetics," *Pocketables.com*, (<http://www.pocketables.net/2009/11/boeye-mid-700-tablet-runs-android-with-applesque-aesthetics.html>), published Nov. 12, 2009, 2 pages.
- Topolsky, "Leaked pics of the CrunchPad make it look dangerously close to availability," *Engadget.com*, (<http://www.engadget.com/2009/04/09/leaked-pics-of-the-crunchpad-make-it-look-dangerously-close-to-a/>), published Apr. 9, 2009, 2 pages.
- Topolsky, "NVIDIA CEO shows off mystery tablet, makes zero statements about mystery tablet," *Engadget.com*, (<http://www.engadget.com/2009/11/09/nvidia-ceo-shows-off-mystery-tablet-makes-zero-statements-about/>), published Nov. 9, 2009, 1 page.
- WebdesignerDepot.com, "The Evolution of Cell Phone Design Between 1983-2009" (<http://www.webdesignerdepot.com/2009/05/the-evolution-of-cell-phone-design-between-1983-2009/>), accessed May 6, 2011, 56 pages.
- Weiss, "Hands-On: NVIDIA Tegra Tablet Prototyp ICD Vega (Video)," (<http://de.engadget.com/2009/11/28/hands-on-nvidia-tegra-tablet-prototyp-icd-vega-video/>), *Engadget German*, published Nov. 28, 2009, 13 pages.
- Wikipedia.org, "CLIE," (<http://en.wikipedia.org/wiki/CLIE>), last modified Feb. 12, 2011, 3 pages.
- Wikipedia.org, "E-Ten" (<http://en.wikipedia.org/wiki/E-TEN>), last modified Dec. 15, 2010, 2 pages.
- Wikipedia.org, "File:LG KE850 Prada Hauptmenü.jpg," (http://en.wikipedia.org/wiki/File:LG_KE850_Prada_Hauptmen%C3%BC.jpg), accessed Feb. 12, 2012, 4 pages.
- Wikipedia.org, "iPAQ" (<http://en.wikipedia.org/wiki/IPAQ>), last modified May 4, 2011, 7 pages.
- Wikipedia.org, "Pocket viewer," (http://en.wikipedia.org/wiki/Pocket_viewer), last modified Apr. 10, 2011, 4 pages.
- Wikipedia.org, "Zire Handheld" (http://en.wikipedia.org/wiki/Zire_Handheld), last modified Dec. 11, 2010, 4 pages.
- Apple's Reply in Support of its Motion for a Preliminary Injunction (Redacted), p. 11, *Apple Inc. v. Samsung Electronics Co., Ltd.*, United States District Court, Northern District of California, San Jose Division, Case No. 11-cv-01846-LHK, dated Oct. 13, 2011, 38 pages total.
- Ballmer, S., *Spiegel Online*, "Bill Gates, Tablet PC: 'Mira' war 2002 die große Vision des Microsoft-Gründers—kam aber wohl zu früh für den Markt," (<http://www.spiegel.de/netzwelt/gadgets/bild-670427-46770.html>), product announced 2002, 4 pages.
- Ballmer, S., *Spiegel Online*, "Tablet PC," (<http://www.spiegel.de/netzwelt/gadgets/0,1518,670427,00.html>), published Jan. 6, 2010, 6 pages.
- Cesweb, "MPIO," (http://www.cesweb.org/shared_files/innovations/innovations_2003/1616/mainphoto1616.jpg), retrieved Feb. 24, 2012, 1 page.
- Chip Online, "VIA: Zwitter-PC für Schöngelster," (http://www.chip.de/ii/202812385_78f68afa8e.jpg), published May 8, 2002, 1 page.
- Chip Online, "VIA: Zwitter-PC für Schöngelster," (http://www.chip.de/news/VIA-Zwitter-PC-fuer-Schoengeister-_34204096.html), published May 8, 2002, 3 pages.
- Cnet, "Sony Clie," (<http://reviews.cnet.com/sc/30733801-2-440-overview-1.gif>), retrieved Feb. 26, 2012, 1 page.
- Computer Museum, "Toshiba Dynapad T100X (1992)," (<http://www.computermuseum.li/Testpage/Toshiba-Dynapad-1992.htm>), product announced Nov. 1992, 1 page.
- De Herrera, C., *tabletpctalk*, "Tatung Tablet PC Picture," (<http://www.tabletpctalk.com/pictures/tatung.shtml>), 2003, 3 pages.
- Dg2000, Flickr, "Sony CLIE PEG-TH55/E1," (<http://www.flickr.com/photos/derekwilkinson/1323901259/>), photo taken Sep. 4, 2007, 2 pages.
- Digibarn Computer Museum, "Image of the GO tablet," (<http://www.digibarn.com/collections/systems/go/DSC02917.JPG>), retrieved Feb. 24, 2012, 1 page.
- Digibarn Computer Museum, "Image of the GO tablet," (<http://www.digibarn.com/collections/systems/go/DSC02942.JPG>), retrieved Feb. 24, 2012, 1 page.
- Falcone, J., *Cnet*, "Digitalway MPIO-FL100 (125 MB)," (http://reviews.cnet.com/mp3-players/digitalway-mpio-fl100-128/4505-6490_7-20763548.html), published Apr. 18, 2003, 8 pages.
- Gilder, G. "Digital Dark Horse—Newspapers," *Forbes ASAP*, published Oct. 25, 1993, 2 pages.
- Gollwitzer, M., et al., *Chip Online*, "Microsofts CeBIT-Neuheiten 2002," (http://www.chip.de/artikel/c_druckansicht_9668117.html), published Mar. 13, 2002, 5 pages.
- Heimi, "MPIO," (<http://www.heimi.net/FlashPlayer/MPIOFL100/pics/01a%20FL100Backlight.jpg>), retrieved Feb. 24, 2012, 1 page.
- Heimkino Markt, "CeBIT 2004 News: Flatron Tablet—TFT-Monitor von LG mit Stifteingabemöglichkeit / Ideal für Industrie- und Designanwendungen," (<http://www.heimkinomarkt.de/News/643/LG/CeBIT%202004%20News%20FLATRON%20TabletTFT%20Monitor%20von/>), published Mar. 25, 2004, 3 pages.
- Justia, "*Apple v. Samsung Electronics Co. Ltd. et al.*, Filing: 166 Attachment: 10," (<http://docs.justia.com/cases/federal/district-courts/california/candce/5:2011cv01846/239768/166/10.html>), dated Aug. 22, 2011, 2 pages.
- Justia, "*Apple v. Samsung Electronics Co. Ltd. et al.*, Filing: 166 Attachment: 11," (<http://docs.justia.com/cases/federal/district-courts/california/candce/5:2011cv01846/239768/166/11.html>), dated Aug. 22, 2011, 2 pages.
- Justia, "*Apple v. Samsung Electronics Co. Ltd. et al.*, Filing: 166 Attachment: 14," (<http://docs.justia.com/cases/federal/district-courts/california/candce/5:2011cv01846/239768/166/14.html>), dated Aug. 22, 2011, 2 pages.
- Justia, "*Apple v. Samsung Electronics Co. Ltd. et al.*, Filing: 166 Attachment: 15," (<http://docs.justia.com/cases/federal/district-courts/california/candce/5:2011cv01846/239768/166/15.html>), dated Aug. 22, 2011, 2 pages.
- Justia, "*Apple v. Samsung Electronics Co. Ltd. et al.*, Filing: 166 Attachment: 16," (<http://docs.justia.com/cases/federal/district-courts/california/candce/5:2011cv01846/239768/166/16.html>), dated Aug. 22, 2011, 2 pages.
- Justia, "*Apple v. Samsung Electronics Co. Ltd. et al.*, Filing: 166 Attachment: 9," (<http://docs.justia.com/cases/federal/district-courts/california/candce/5:2011cv01846/239768/166/9.html>), dated Aug. 22, 2011, 2 pages.
- Justia, "*Apple v. Samsung Electronics Co. Ltd. et al.*, Filing: 456 Attachment: 5," (<http://docs.justia.com/cases/federal/district-courts/california/candce/5:2011cv01846/239768/456/5.html>), dated Dec. 7, 2011, 3 pages.
- Justia, "*Apple v. Samsung Electronics Co. Ltd. et al.*, Filing: 456 Attachment: 6," (<http://docs.justia.com/cases/federal/district-courts/california/candce/5:2011cv01846/239768/456/6.html>), dated Dec. 7, 2011, 3 pages.
- Justia, "*Apple vs. Samsung Electronics Co. Ltd. et al.*, Filing: 456 Attachment: 7," (<http://docs.justia.com/cases/federal/district-courts/california/candce/5:2011cv01846/239768/456/7.html>), dated Dec. 7, 2011, 3 pages.
- Long, B., *Macworld*, "PL500 LCD Pen Tablet System," (<http://images.macworld.com/images/legacy/2001/02/images/content/wacom.gif>), published Feb. 1, 2001, 1 page.
- Long, B., *Macworld*, "PL500 LCD Pen Tablet System," (<http://www.macworld.com/article/1938/2001/02/wacomtablet.html>), published Feb. 2, 2001, 1 page.
- Markoff, J., "A Media Pioneer's Quest: Portable Electronic Newspapers," *The New York Times*, published Jun. 28, 1992, p. 11.
- Microsoft, "Bill Gates Highlights the Magic of Consumer Software And the Coming Digital Decade at Consumer Electronics Show," (<http://www.microsoft.com/presspass/press/2002/jan02/01-07ces2002keynotepr.mspx>), published, Jan. 7, 2002, 3 pages.
- Monitor4u, "Flatron L1530TM," (<http://www.monitor4u.co.kr/review/review4u/content.asp?idx=580&leftcode=16>), published Mar. 17, 2004, 7 pages.

- Old Computers, "Toshiba T100-X Dynapad," (<http://www.old-computers.com/museum/computer.asp?st=1&c=801>), product released 1993, 2 pages.
- Oullette, D., "Dynapad weighs in at just 3.3 pound," *Info World*, vol. 15, Issue 31, Aug. 2, 1993, 2 pages.
- PDA Museum, "Sony Clie," (http://www.pdamuseum.com/sony_clie/clie_pics/th-55j2.jpg), retrieved Feb. 26, 2012, 1 page.
- Presstime, "Life After Viewtron? Enter the E-Paper," *Presstime*, published Aug. 1993, p. 18-19.
- Sony, "The Sony CLIE PEG-TH55 heralds The Next Generation Of Digital Organisers," (<http://dpnow.com/595.html>), published Feb. 13, 2004, 2 pages.
- Tatung, "Comdex Fall 2003 Tatung Booth# 10248," (<http://www.tatung.com/en/news/comdex2003.htm>), published Nov. 17, 2003, 2 pages.
- Toshiba, "Dynapad T100X," product announced Nov. 1992, 2 pages.
- Wacom, "Company History, PL-500," (<http://wacom.jp/en/company/history/>), product released Jun. 2000, 1 page.
- Wikimedia, "MPIO," (http://upload.wikimedia.org/wikipedia/commons/e/e9/M-Pio_FL100.jpg), retrieved Feb. 24, 2012, 1 page.
- Wiley, M., *IGN*, "MPIO FL100 Review," (<http://uk.ign.com/articles/2003/01/21/mpio-fl100-review>), published Jan. 21, 2003, 4 pages.
- Amazon, "Developing Tablet PC Applications—(Charles River Media Programming)," (<http://www.amazon.co.uk/Developing-Tablet-Applications-Charles-Programming/dp/1584502525>), retrieved Jul. 20, 2011, 4 pages.
- Arrington, M., *TechCrunch.com*, "CrunchPad: The Launch Prototype," (<http://techcrunch.com/2009/06/03/crunchpad-the-launch-prototype/>), published Jun. 3, 2009, 17 pages.
- Arrington, M., *TechCrunch.com*, "TechCrunch Tablet Update: Prototype B," (<http://techcrunch.com/2009/01/19/techcrunch-tablet-update-prototype-b/>), published Jan. 19, 2009, 25 pages.
- Association for Computing Machinery, *The Open Video Project*, "ACM CHI 1995—The Tablet Newspaper: A vision for the Future," (<http://www.open-video.org/details.php?videoid=8315&surrogate=storyboard>), 3 pages (1994).
- Aumente, J., *American Journalism Review*, "Panel Vision," (<http://www.ajr.org/Article.asp?id=1257>), published Oct. 1994, 7 pages.
- Axiotron, "Axiotron at Macworld Expo 2009," (<http://www.axiotron.com/index.php?id=events>), retrieved Jun. 1, 2011, 4 pages.
- Blickenstorfer, C., *PenComputing Magazine*, "Tablet PCs: HP Compaq Tablet PC TC1000," (http://pencomputing.com/frames/tpc_compaq.html), 3 pages (Dec. 2002).
- Blickenstorfer, C., *PenComputing Magazine*, "Tablet PCs: Motion Computing M1200," (http://pencomputing.com/frames/tpc_motion1200.html), 3 pages (Dec. 2002).
- Blickenstorfer, C., *PenComputing Magazine*, "Tablet PCs: ViewSonic V1100," (http://pencomputing.com/frames/tpc_viewsonic.html), 3 pages (Dec. 2002).
- Chi-atheneum, "Good Design 2003, An International Industrial and Graphic Design Competition," (<http://www.chi-atheneum.org/gdesign/winners03.htm>), retrieved Sep. 23, 2011, 7 pages.
- Chubb, D., *Product-reviews.net*, "Amtek's iTablet T221: new to the tablet and UMPC scene," (<http://www.product-reviews.net/2008/01/11/amteks-itablet-t221-new-to-the-tablet-and-umpc-scene/>), published Jan. 11, 2008, 4 pages.
- Cnet, "HP Compaq Tablet PC TC1000 Review," http://reviews.cnet.com/tablet-pcs/hp-compaq-tablet-pc/4505-3126_7-20627295.html, published Nov. 6, 2002, 8 pages.
- Coldewey, D., *CrunchGear.com*, "TechCrunch Tablet makes an early debut," (<http://www.crunchgear.com/2009/04/09/crunchtablet-hits-the-net-a-little-early/>), published Apr. 4, 2009, 26 pages.
- Computing History, "GRidPad 1910," (<http://computinghistory.org.uk/det/6565/GRidPad-1910>), retrieved Sep. 12, 2011, 2 pages.
- Davies, C., *Slashgear.com*, "Are Dell planning a keyboard-less UMPC?," (<http://www.slashgear.com/are-dell-planning-a-keyboard-less-umpc-096130/>), published Jul. 9, 2007, 15 pages.
- Digibarn Computer Museum, "PenPoint tablet pen computer by GO Corporation," (<http://www.digibarn.com/collections/systems/go/index.html>), retrieved Jul. 18, 2011, 6 pages.
- DigiBarn Systems, "GRidPad Pen Computer," (<http://www.digibarn.com/collections/systems/gridpad/index.html>), retrieved Sep. 23, 2011, 2 pages.
- Dunn, J., *DigitalHomeThoughts.com*, "Ultra-Portable Concept PC Shown at WinHEC 2005," (<http://www.digitalhomethoughts.com/news/show/27459/ultra-portable-concept-pc-shown-at-winhec-2005.html>), published Apr. 26, 2005, 4 pages.
- Edible Apple, "The first Apple Tablet . . . from 1979," (<http://www.edibleapple.com/the-first-apple-tablet-from-1979/>), published Nov. 23, 2009, 8 pages.
- Electronista, "LG/Prada phone revealed?," (<http://www.electronista.com/articles/06/12/20/lg.prada.phone.revealed/>), updated Dec. 20, 2006, 9 pages.
- Electrovaya, "Electrovaya Launches Scribbler® SC4000 Series Tablet PC," published Jan. 9, 2008, 2 pages.
- EngineerBoy, *CleverDonkey.com*, "2001:A Space Odyssey and the iPad (or is it tamPod?)," (<http://www.cleverdonkey.com/1499-2001a-space-odyssey-and-the-ipad-or-is-it-tampod/>), published Feb. 2, 2010, 5 pages.
- Gizmodo, "Kurztest: JooJoo (Crunchpad)—riesiges Internet-Tablet," (<http://www.gizmodo.de/2009/12/09/kurztest-joojoo-crunchpad-riesiges-internet-tablet-html>), retrieved Sep. 26, 2011, 13 pages.
- Hagen, R., *GadgetZone*, "iHolic portable mediaspeler," (<http://www.gadgetzone.nl/nieuws.php?id=3191>), published Jan. 4, 2007, 3 pages.
- Jarrett, R. et al., *Building Tablet PC Applications*, pp. 38, Microsoft Press, Redmond, Washington, (2003).
- Kahney, L., *Wired*, "Apple's Newton Just Won't Drop," (<http://www.wired.com/gadgets/mac/commentary/cultofmac/2002/08/54580>), published Aug. 29, 2002, 2 pages.
- Lerg, A., *T Online*, "Billig-Tablet-Computer vom Grabbeltisch," (http://digitalleben.t-online.de/tablet-pc-von-jay-tech-fuer-140-euro-bei-rossmann/id_43326132/index), published Mar. 11, 2010, 2 pages.
- Loyola, R., *MacWorld.com*, "First Look: Axiotron Modbook Pro," (<http://www.macworld.com/article/137878/2009/01/mwvodcast86.html>), published Jan. 6, 2009, 2 pages.
- Martin, T., "The Tablet Newspaper: A Vision for the Future," *Human Factors in Computing Systems, Chi '95 Conference Companion*, pp. 425, Colorado, United States (May 1995).
- NewGadgets, "Mysteriöser Tablet-PC?," (<http://www.newgadgets.de/6072/mysteriöser-tablet-pc/>), retrieved Jun. 1, 2011, 6 pages.
- NewLaunches, "LG Prada cell phones are truly iconic," (http://www.newlaunches.com/archives/lg_prada_cell_phones_are_truly_iconic.php), retrieved Sep. 12, 2011, 3 pages.
- NewLaunches, "LG Wears Prada," (http://www.newlaunches.com/archives/lg_wears_prada.php), retrieved Sep. 23, 2011, 2 pages.
- NotebookCheck, "Fujitsu-Siemens Stylistic ST5022," (<http://www.notebookcheck.com/typo3temp/pics/d675d29c1f.jpg>), retrieved Sep. 26, 2011, 1 page.
- PC Magazine, "HP Compaq Tablet PC TC1000," (<http://www.pcmag.com/article2/0,2817%20,939500,00.asp>), published Apr. 8, 2003, 3 pages.
- RadioShack, "Motorola DEFY with MOTOBLUR Black," (http://radioshackwireless.com/eCommerce/SpecialOffer.aspx?cid=25578_47f08265355e4a8a92dcd57eed6cbc69), 1 page.
- Samsung, "Samsung F700 is razendsnelle alleskunner voor mobiel breedband van Vodafone," (http://www.samsung.com/nl/mobile/pressView.do?type=press&page=13&news_seq=22544) published May 25, 2008, 2 pages.
- Samsung, "Samsung Unveils Revolutionary Ultra Smart F700," (http://www.samsung.com/us/news/newsRead.do?news_seq=3516), published Nov. 23, 2009, 2 pages.
- Sierra, *LaptopsArena*, "Amtek Releases the iTablet T221 Tablet PC, Laptops Arena," (<http://www.laptopsarena.com/amtek-releases-the-itablet-t221-tablet-pc/>), published Dec. 22, 2007, 5 pages.
- Smith, C., *HuffPost Tech*, "History of Tablet PCs (Photos): A Pictorial Timeline Of Tablets, From RAND to The iPad," (http://www.huffingtonpost.com/2010/04/15/history-tablet-pc-photos_n_538806.html), published Apr. 15, 2010, 5 pages.
- Sze, *iTechNews Net*, "Amtek has five iTablets for the Computex 2010," (<http://www.itechnews.net/2010/05/27/amtek-has-five-itables-for-the-computex-2010/>), retrieved Jun. 3, 2011, 13 pages.

- Tan, K., Shanghaiist, "ZOMG! Maker of Chinese iPad clone P88 to sue Apple for cloning its tablet!," (<http://shanghaiist.com/2010/01/29/p88-chinese-ipad-clone-sues-apple.php>), published Jan. 29, 2010, 5 pages.
- Topolsky, J., Engadget, "Amtek intros the iTablet T221 UMPC," (<http://www.engadget.com/2007/12/18/amtek-intros-the-itablt-t221-umpc/>), published Dec. 18, 2007, 3 pages.
- Van Reeth, J., "Vantage is showing its colours!," *Home automation journal* 11:1-8, Vantage Emea, Belgium (Jun. 2003).
- Wikipedia, "Axiotron Modbook," (http://en.wikipedia.org/wiki/Axiotron_Modbook), updated Apr. 18, 2011, 4 pages.
- Wikipedia, "Datei:Modbook pro.jpg," (http://de.wikipedia.org/wiki/Datei:Modbook_pro.jpg), taken Jan. 9, 2009, 4 pages.
- Wikipedia "Datei:VIA Tablet PC Reference Design.jpg," (http://de.wikipedia.org/wiki/Datei:VIA_Tablet_PC_Reference_Design.jpg), taken Nov. 16, 2007, 3 pages.
- Wikipedia, "Dynabook," (<http://de.wikipedia.org/wiki/Dynabook>), updated Apr. 2, 2011, 2 pages.
- Wikipedia, "Etch A Sketch," (http://en.wikipedia.org/wiki/Etch_a_sketch), last modified Aug. 24, 2011, 4 pages.
- Wikipedia, "MessagePad," (<http://en.wikipedia.org/wiki/Messagepad>), retrieved Sep. 12, 2011, 10 pages.
- Wikipedia, "Tablet-Computer," (<http://de.wikipedia.org/wiki/Tablet-Computer>), updated Apr. 7, 2011, 3 pages.
- Wikipedia, "Tablet-PC," (<http://de.wikipedia.org/wiki/Tablet-PC>), retrieved Apr. 14, 2011, 2 pages.
- ZDNet, "Viewsonic V1100," (<http://www.zdnet.nl/reviews/24712/viewsonic-v1100/>), published Feb. 17, 2003, 9 pages.
- Ziegler, C., Engadget, "The LG KE850: touchable chocolate," (<http://mobile.engadget.com/2006/12/15/the-lg-ke850-touchable-chocolate/>), published Dec. 15, 2006, 5 pages.
- Request for declaration of invalidity of design No. 001222905-0002 registered on behalf of Apple Inc., dated May 5, 2011, 7 pages.
- Request for Re-examination of Australian Design Registration Nos. 337931, 337833, 337832, 3 pages.
- Rothman, W., Gizmodo, "HP's Windows 7 Slate Device Revealed by Steve Ballmer," (<http://gizmodo.com/5442200/hps-windows-7-slate-device-revealed-by-steve-ballmer>), published Jan. 6, 2010, 8 pages.
- Smith, T., RegHardware.com, "First fondleslab found in 1970s kids TV sci-fi gem," (http://www.reghardware.com/2011/02/07/apple_ipad_tomorrow_people/print.html), published Feb. 7, 2011, 3 pages.
- The Internet Movie Database, "The Tomorrow People," (<http://www.imdb.com/title/tt0069647/>), retrieved Oct. 11, 2011, 5 pages.
- Arrington, Michael, CrunchPad: The Launch Prototype, 6 pages, <http://techcrunch.com/2009/06/03/crunchpad-the-launch-prototype/>, Jun. 3, 2009.
- Coldeway, Devin, TechCrunch Tablet makes an early debut, 3 pages, <http://crunchgear.com/2009/04/09/crunchtablet-hits-the-net-a-little-early/>, Apr. 9, 2009.
- Davies, Chris, Are Dell planning a keyboard-less UMPC?, 14 pages, <http://www.slashgear.com/are-dell-planning-a-keyboard-less-umpc-096130/>, Jul. 9, 2007.
- Newgadgets.de, Mysterioser Tablet-PC?, 8 pages, <http://www.newgadgets.de/6072/mysterioser-tablet-pc/>, Nov. 10, 2009.
- Lerg, Andreas, Billig-Tablet-Computer vom Grabbeltisch, 3 pages, http://digitalleben.t-online.de/tablet-pc-von-jay-tech-flaer-140-euro-bei-rossmann/id_43326132/index, Nov. 3, 2010.
- Wikipedia, der freien Enzyklopaedie, Datei:Xo3-fuse-2.jpg, 3 pages, <http://de.wikipedia.org>, Dec. 22, 2009.
- Topolsky, Joshua, Amtek intros the iTablet T221 UMPC, 5 pages, <http://www.engadget.com/2007/12/18/amtek-intros-the-itablt-t221-umpc/>, Dec. 18, 2007.
- Loyola, Roman, Macworld Video: Axiotron Modbook Pro first look, 4 pages, <http://www.macworld.com/article/137878/2009/O1/mwvodcase86.htm>, Jan. 5-9, 2009.
- Sze, Amtek has five iTablets for the Computex 2010, 13 pages, <http://www.itechnews.net/2010/05/27/amtek-has-five-itablt-for-the-computex-2010/>.
- Axiotron, Modbook Pro, 2 pages, <http://www.axiotron.com/index.php?id=modbrookpro>.
- 40 E-Reader Devices, Independent Reviews and User Ratings, 18 pages, <http://www.e-reader.reviews.com>.
- Scrapin_frame, S-10 Forum, "fs: 2 lg flatiron tablet monitors," published Nov. 27, 2011 [online] [retrieved Mar. 19, 2012]. Retrieved from Internet, <http://www.s10forum.com/forum/f296/fs-2-lg-flatiron-tablet-monitors-483210>.
- 01net, "Fiche Technique Philips SPH8008," (<http://www.01net.com/fiche-produit/fiche-technique-7075/cadres-numeriques-philips-sph8008/>), retrieved Nov. 21, 2011, 7 pages.
- 01net, "Fiche Technique Philips SPH8008," (<http://www.01net.com/images/produit/full/philips-sph8008-1.jpg>), retrieved Nov. 21, 2011, 1 page.
- 01net, "Fiche Technique Philips SPH8008," (<http://www.01net.com/images/produit/fall/philips-sph8008-2.jpg>), retrieved Nov. 21, 2011, 1 page.
- 01net, "Fiche Technique Philips SPH8008," (<http://www.01net.com/images/produit/full/philips-sph8008-3.jpg>), retrieved Nov. 21, 2011, 1 page.
- 01net, "Fiche Technique Philips SPH8008," (<http://www.01net.com/images/produit/full/philips-sph8008-4.jpg>), retrieved Nov. 21, 2011, 1 page.
- Amazon, "STL Deutschland Digitaler Bilderrahmen DF-711 B," (<http://www.amazon.de/STL-Deutschland-Digitaler-Bilderrahmen-DF-711/dp/B002D5K6YK>), retrieved Nov. 21, 2011, 4 pages.
- Apple Computer, Inc., "Apple Cinema Display," 1999, 21 pages.
- Apple Computer, Inc., "Setting Up Your Studio Display 15-Inch flat panel monitor," 1999, 37 pages.
- Apple Inc., "iPod touch (2nd generation)," (<http://support.apple.com/kb/ht1353>), retrieved Nov. 21, 2011, 1 page.
- Arrington, M., TechCrunch, "We Want A Dead Simple Web Tablet For \$200. Help Us Build It.," (<http://techcrunch.com/2008/07/21/we-want-a-dead-simple-web-tablet-help-us-build-it/>), published Jul. 21, 2008, 4 pages.
- Bookeen, "New Cybook OPUS," (<http://www.bookeen.com/ebook/ebook-reading-deviceaSPX>), retrieved Apr. 26, 2010, 2 pages.
- Bower, G., MacPredictions, "iPod Tablet [Mockup]," (<http://www.macpredictions.com/2009/04/ipod-tablet-mockup.html>), published Apr. 18, 2009, 8 pages.
- Cashmore, P., Mashable, "Apple Tablet: Ultimate Gallery of Concept Designs and Prototypes," (<http://mashable.com/2009/08/07/apple-tablet-gallery/>), published Aug. 7, 2009, 28 pages.
- Focus Online, "Rollei DF8 DVB-T," (http://www.focus.de/digital/foto/rollei-df8-dvb-t-fernsehen-im-bilderrahmen_did_27152.html), published Feb. 18, 2010, 3 pages.
- Foto-Branche.de, "Kodak EasyShare S730: Digitaler Bilderrahmen mit integriertem Akku," (<http://www.foto-branche.de/news/singleview/browse/2/article/kodak-easyshare-s730-digitaler-bilderrahmen-mit-integriertem-akku/2.html>), published Jul. 13, 2009, 2 pages.
- Fotofabrikas, "AgfaPhoto AF 5087 MS 8," (http://www.fotofabrikas.lt/data/images/catalog_pics/n_preview/Skaitmeniniai%20remeliamai%20AgfaPhoto%20AF%205087%20MS%208%20skaitmeninis%20melis_01.jpg), retrieved Nov. 22, 2011, 1 page.
- Fotofabrikas, "AgfaPhoto AF 5087 MS 8," (<http://www.fotofabrikas.lt/en/items/Digital-Frames/Digital-photo-frames/2636ee4.2-AgfaPhoto-AF-5087-MS-8.html>), retrieved Nov. 21, 2011, 5 pages.
- Funamizu, M., Petitinvention, "(iPod Touch + iMac + Macbook Air) 3," (<http://petitinvention.wordpress.com/2008/05/03/ipod-touch-imac-macbook-air-3/>), published May 3, 2008, 4 pages.
- GadgetFolder, "iRex Digital Reader 800 with 8-inch touchscreen and wireless," (<http://www.gadgetfolder.com/irex-digital-reader-800-with-8-inch-touchscreen-and-wireless.html>), published Aug. 9, 2009, 5 pages.
- HardwareZone, "HP Compaq Tablet PC TC1000," (<http://www.hardwarezone.com.au/reviews/view.php?cid=45&id=533&pg=2>), retrieved Apr. 20, 2010, 1 page.
- Justia, "Apple v. Samsung Electronics Co. Ltd. et al, Filing: 427 Attachment: 42," (<http://docs.justia.com/cases/federal/district-courts/california/candce/5:2011cv01846/239768/427/42.html>), dated Nov. 28, 2011, 3 pages.

Justia, “*Apple v. Samsung Electronics Co. Ltd. et al*, Filing: 427 Attachment: 43,” (<http://docs.justia.com/cases/federal/district-courts/california/candce/5:2011cv01846/239768/427/43.html>), dated Nov. 28, 2011, 3 pages.

Justia, “*Apple v. Samsung Electronics Co. Ltd. et al*, Filing: 427 Attachment: 44,” (<http://docs.justia.com/cases/federal/district-courts/california/candce/5:2011cv01846/239768/427/44.html>), dated Nov. 28, 2011, 3 pages.

Kahney, L., Cult of Mac, “Mac Air Tablet Mockup From Isamu Sanada,” (<http://www.cultofmac.com/1952/mac-air-tablet-mockup-from-isamu-sanada/>), published May 6, 2008, 13 pages.

KingVision, “Digital Photo Frame,” (http://www.sz-kingvision.com/product.php?type_id=1&weblan=e), retrieved Nov. 21, 2011, 2 pages.

KingVision, “DPF-1902,” (http://www.sz-kingvision.com/product_disp.php?productid=24&weblan=e), retrieved Nov. 21, 2011, 3 pages.

Kowalski, M., “Review: Kodak EasyShare S730,” Digital Picture Frame Review, (<http://www.digitalpictureframereview.com/2009/07/review-kodak-easyshare-s730/>), published Jul. 17, 2009, 14 pages.

Lazar, L., Cult of Mac, “Mac Pad Mock Up,” (<http://www.cultofmac.com/4921/mac-pad-mock-up/>), published Nov. 19, 2008, 12 pages.

McCracken, H., PCWorld, “CES: Plastic Logic’s Que E-Reader Revealed,” (http://www.pcworld.com/article/186224/ces_plastic_logics_que_ereader_revealed.html), published Jan. 7, 2010, 1 page.

Murph, D., Engadget, “BeBook Neo e-reader launches with WiFi and WACOM capabilities,” (<http://www.engadget.com/2010/01/22/bebook-neo-e-reader-launches-with-wifi-and-wacom-capabilities/>), published Jan. 22, 2010, 2 pages.

My Burmese Blog, “Apple Touch Screen Netbook Prototypes Hit The Web,” (<http://www.htootayzar.com/myblog/2009/03/apple-touch-screen-netbook-prototypes-hit-the-web/>), published Mar. 12, 2009, 10 pages.

Netzwelt, “Rollei DF8 DVB-T,” (<http://www.netzwelt.de/news/81537-rollei-df8-dvb-t-test-digitaler-bilderrahmen-mini-ferseher.html>), retrieved Nov. 21, 2011, 10 pages.

PCWorld, “The Best of CES 2010,” (http://www.pcworld.com/article/186511/another_excellent_ereader.html), published Jan. 8, 2010, 1 page.

Samsung, “Samsung Introduces UltraThin Touch of Color Photo Frame,” (http://www.samsung.com/us/news/newsPreviewRead.do?news_seq=13462), published May 23, 2009, 2 pages.

Samsung, “Samsung’s Digital Photo Frames,” (http://www.samsung.com/hk_en/consumer/detail/productPreviewRead.do?model_cd=LP081PLSB/XK&group=photography&type=photo-frame&subtype=photo-frame), retrieved Nov. 21, 2011, 4 pages.

Savov, V., Engadget, “NVIDIA Tegra tablet prototype hands-on,” (<http://www.engadget.com/2009/11/27/nvidia-tegra-tablet-prototype-hands-on/>), published Nov. 27, 2009, 5 pages.

Savov, V., Engadget, “NVIDIA Tegra tablet prototype hands-on,” (<http://www.engadget.com/photos/nvidia-tegra-tablet-prototype/#2485983>), published Nov. 27, 2009, 2 pages.

Savov, V., Engadget, “NVIDIA Tegra tablet prototype hands-on,” (<http://www.engadget.com/photos/nvidia-tegra-tablet-prototype/#2485984>), published Nov. 27, 2009, 2 pages.

Savov, V., Engadget, “NVIDIA Tegra tablet prototype hands-on,” (<http://www.engadget.com/photos/nvidia-tegra-tablet-prototype/#2485985>), published Nov. 27, 2009, 2 pages.

Savov, V., Engadget, “NVIDIA Tegra tablet prototype hands-on,” (<http://www.engadget.com/photos/nvidia-tegra-tablet-prototype/#2485986>), published Nov. 27, 2009, 2 pages.

Savov, V., Engadget, “NVIDIA Tegra tablet prototype hands-on,” (<http://www.engadget.com/photos/nvidia-tegra-tablet-prototype/#2485987>), published Nov. 27, 2009, 2 pages.

Savov, V., Engadget, “NVIDIA Tegra tablet prototype hands-on,” (<http://www.engadget.com/photos/nvidia-tegra-tablet-prototype/#2485988>), published Nov. 27, 2009, 2 pages.

Savov, V., Engadget, “NVIDIA Tegra tablet prototype hands-on,” (<http://www.engadget.com/photos/nvidia-tegra-tablet-prototype/#2485989>), published Nov. 27, 2009, 2 pages.

Savov, V., Engadget, “NVIDIA Tegra tablet prototype hands-on,” (<http://www.engadget.com/photos/nvidia-tegra-tablet-prototype/#2485990>), published Nov. 27, 2009, 2 pages.

Savov, V., Engadget, “NVIDIA Tegra tablet prototype hands-on,” (<http://www.engadget.com/photos/nvidia-tegra-tablet-prototype/#2485991>), Nov. 27, 2009, 2 pages.

Savov, V., Engadget, “NVIDIA Tegra tablet prototype hands-on,” (<http://www.engadget.com/photos/nvidia-tegra-tablet-prototype/#2485992>), published Nov. 27, 2009, 2 pages.

Schulze, S. and Gratz, I., “1999 | Studio Display,” in *Apple Design*, pp. 144-145, Hatje Cantz Verlag, Ostfildern, Germany (2011).

Softgate, “Fujifilm FinePix Real 3D V1,” (http://www.softgate.ch/ger_details_31383/Fujifilm_FinePix_Real_3D_V1_Viewer_8_TFT.html), published Apr. 16, 2010, 2 pages.

Tc-one-thousand, “HP Compaq Tablet PC TC1000,” (<http://www.tc-one-thousand.com>), retrieved Apr. 20, 2010, 2 pages.

Testberichte.de, “Fuji FinePix Real 3D V1,” (<http://www.testberichte.de/p/philips-tests/digital-photoframe-sph8008-testbericht.html>), retrieved Nov. 21, 2011, 3 pages.

Testberichte.de, “Philips Digital PhotoFrame SPH8008,” (<http://www.testberichte.de/p/philips-tests/digital-photoframe-sph8008-testbericht.html>), retrieved Nov. 21, 2011, 4 pages.

Touch User Guide, “What will the new Apple Tablet look like? Apple tablet images leaked?,” (<http://www.touchuserguide.com/2009/07/29/what-will-the-new-apple-tablet-look-like/>), published Jul. 29, 2009, 29 pages.

Toxel.com “12 Cool Apple Tablet Concepts,” (<http://www.toxel.com/tech/2009/08/31/12-cool-apple-tablet-concepts/>), published Aug. 31, 2009, 16 pages.

Verkehrsrundschau, “Details zum Digitalen Bilderrahmen,” (http://www.verkehrsrundschau.de/fotowettbewerb-mein-tag-der-logistik-835123.html?_apg=2), published Apr. 27, 2009, 1 page.

Vilas-Boas, R., “Nokia I.D.,” (<http://rdvb-designshowcase.blogspot.com/p/cheddar-1-2009.html>), retrieved Nov. 7, 2011, 6 pages.

Yatego Shopping, “Lenco Digitaler Bilderrahmen DF-911 B,” (<http://www.yatego.com/index.htm?cl=spotshopping&popup=media&pid=4a13d0ce891ff>), retrieved Nov. 21, 2011, 1 page.

U.S. Appl. No. 29/432,444, filed Sep. 14, 2012, inventors Akana, et al., “Portable Display Device” (not published).

<http://www.google.com/py/search?tbm=isch&hl=es&source=hp&biw=1280&bih=898&q=visualizador+portatil&gbv=2&oq>, cited in Paraguay Appl. No. 27811/2011 in search dated May 30, 2012, 1 page.

GSMarena.com, “HTC Flyer pictures”, http://www.gsmarena.com/htc_flyer-pictures-3829.php, accessed Apr. 2, 2013, 3 pages.

GSMarena.com, “ZTE Light Tab 2 V9A pictures”, http://www.gsmarena.com/zte_light_tab_2_v9a-pictures-4467.php, accessed Apr. 2, 2013, 1 page.

GSMarena.com, “ZTE Light Tab V9C pictures”, http://www.gsmarena.com/zte_light_tab_v9c-pictures-4466.php, accessed Apr. 2, 2013, 1 page.

GSMarena.com, “ZTE V9 pictures”, http://www.gsmarena.com/zte_v9-pictures-3903.php, accessed Apr. 2, 2013, 1 page.

* cited by examiner

Primary Examiner — Barbara Fox

(74) *Attorney, Agent, or Firm* — Sterne, Kessler, Goldstein & Fox PLLC

(57)

CLAIM

The ornamental design for a portable display device, as shown and described.

DESCRIPTION

FIG. 1 is a top front perspective view of a portable display device showing our new design;

FIG. 2 is a bottom rear perspective view thereof;

FIG. 3 is a front view thereof;

FIG. 4 is a rear view thereof;
FIG. 5 is a left side view thereof;
FIG. 6 is a right side view thereof;
FIG. 7 is a top view thereof;
FIG. 8 is a bottom view thereof;
FIG. 9 is an enlarged view of the left corner of FIG. 8;
FIG. 10 is an enlarged view of the right corner of FIG. 8;
FIG. 11 is a top front perspective view of another embodiment of a portable display device showing our new design;
FIG. 12 is a bottom rear perspective view thereof;
FIG. 13 is a front view thereof;
FIG. 14 is a rear view thereof;
FIG. 15 is a right side view thereof;
FIG. 16 is a left side view thereof;

FIG. 17 is a top view thereof;
FIG. 18 is a bottom view thereof;
FIG. 19 is an enlarged view of the left corner of FIG. 18; and,
FIG. 20 is an enlarged view of the right corner of FIG. 18.
The broken lines in the Figures show portions of the portable display device which form no part of the claimed design.
The shade lines in the Figures show contour and not surface ornamentation.
The embodiments of FIGS. 1-11 and FIGS. 12-20 are illustrated to show color and contrasts. The front face of the portable display device is white and dark gray. The back and side surfaces are a lighter gray and black.

1 Claim, 14 Drawing Sheets

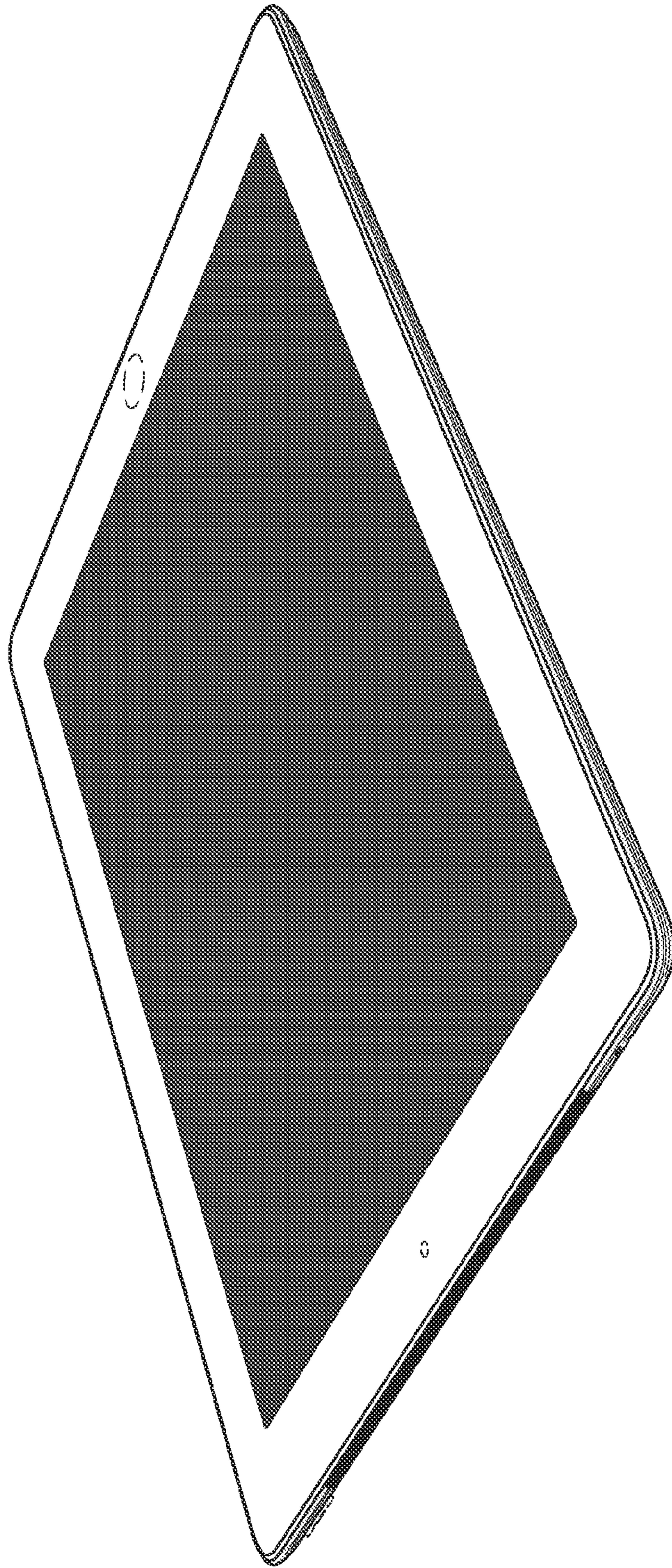

FIG. 1

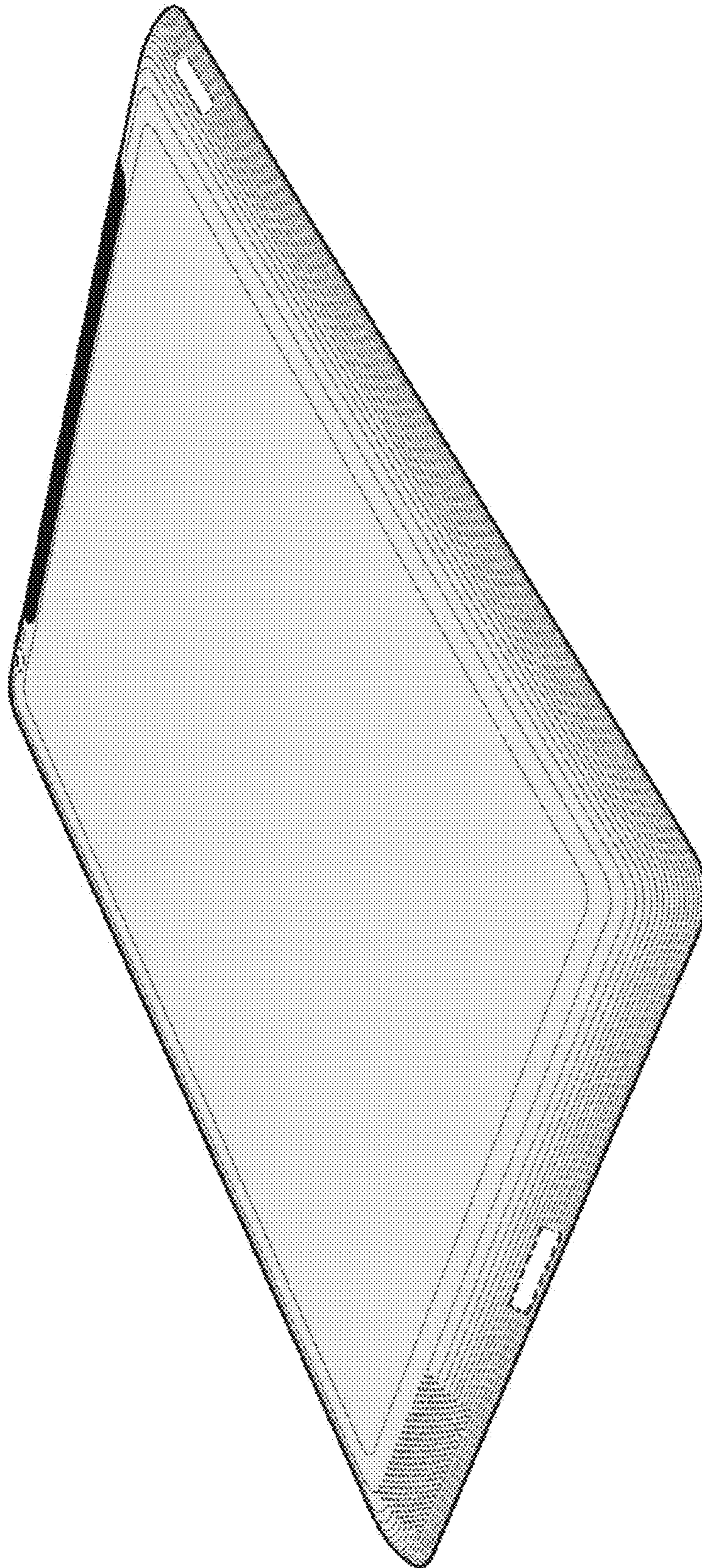

FIG. 2

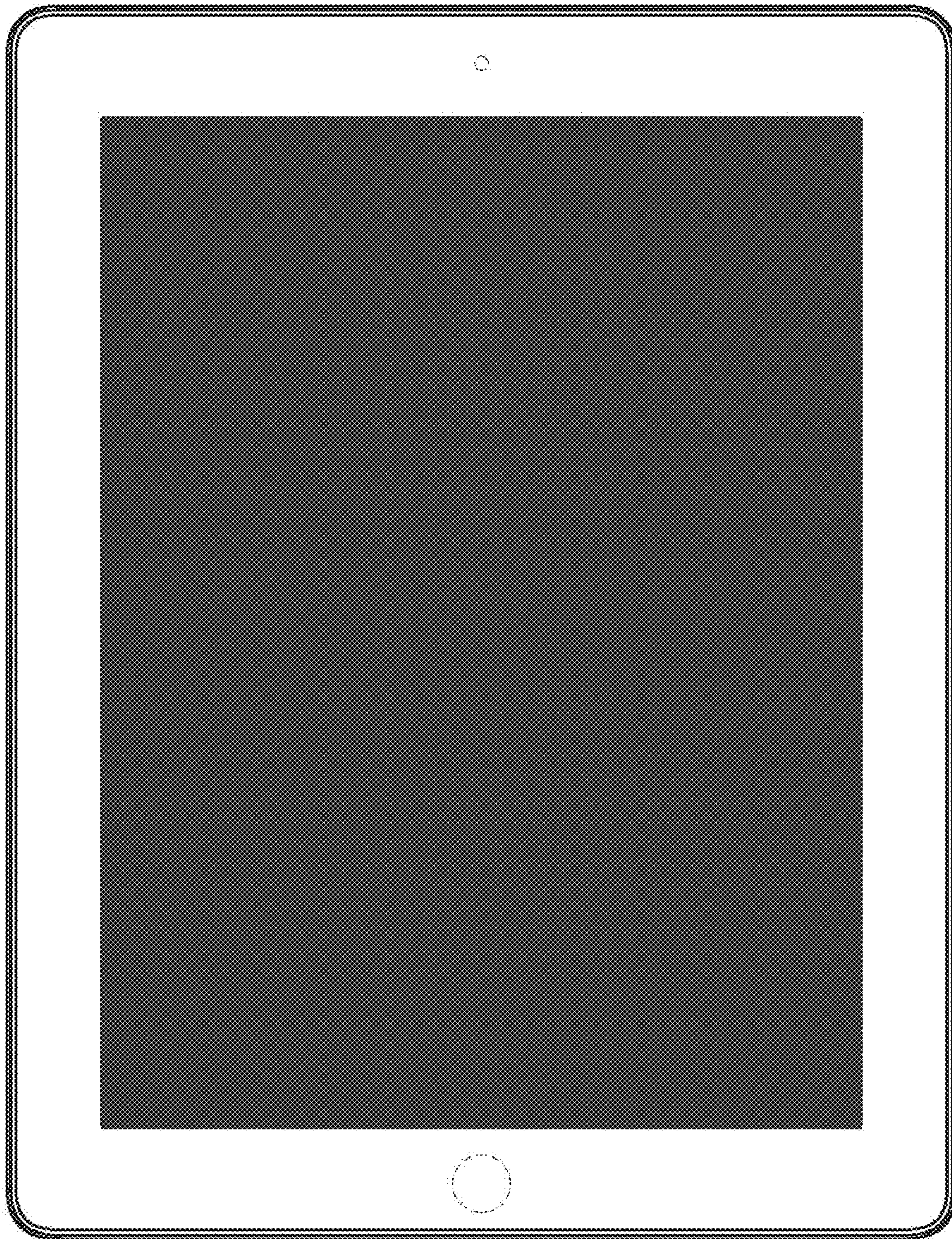

FIG. 3

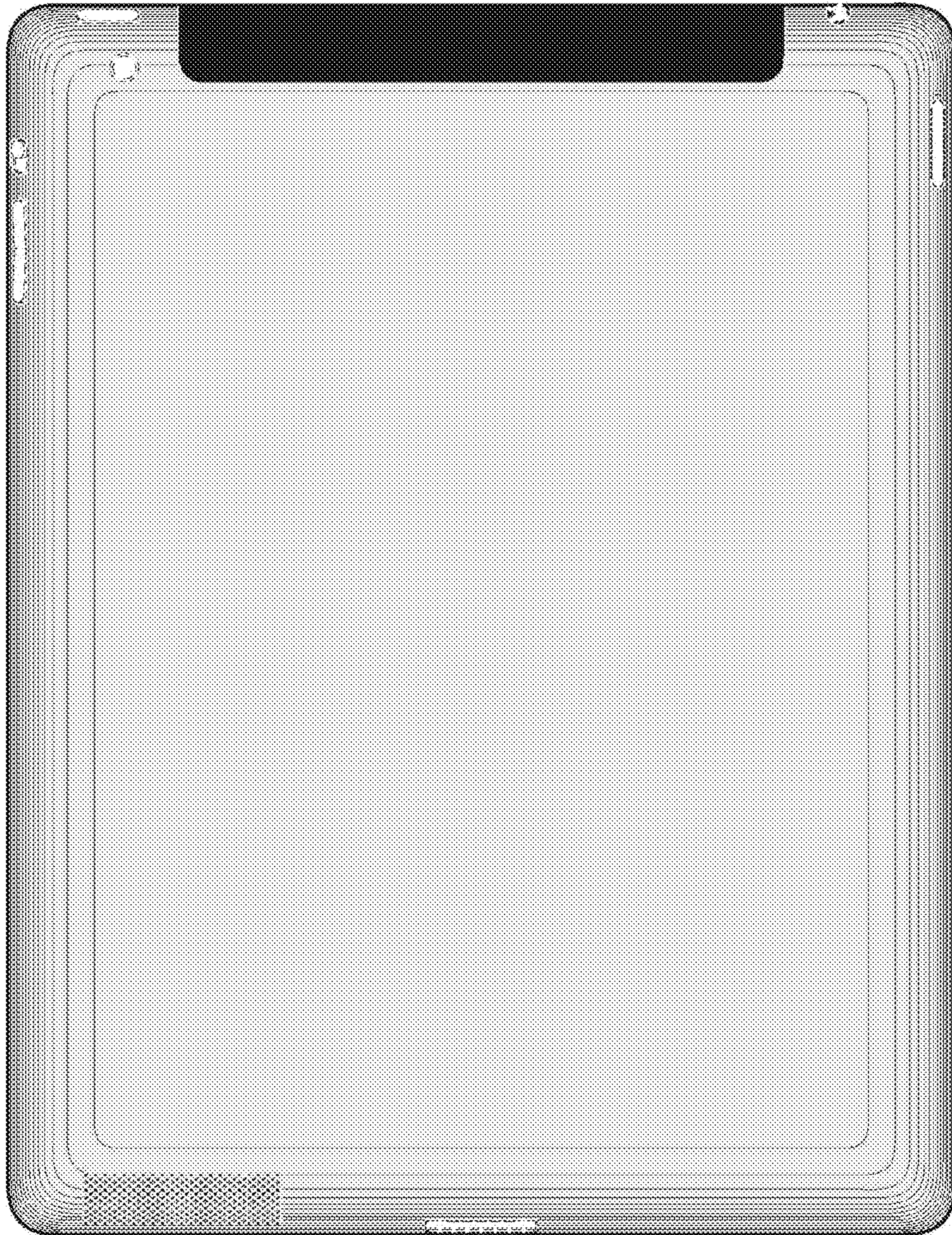

FIG. 4

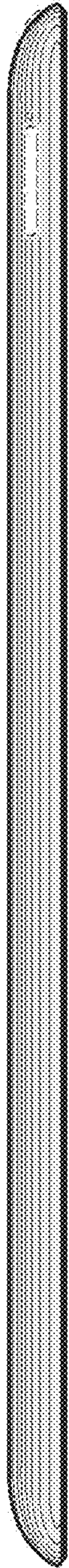

FIG. 5

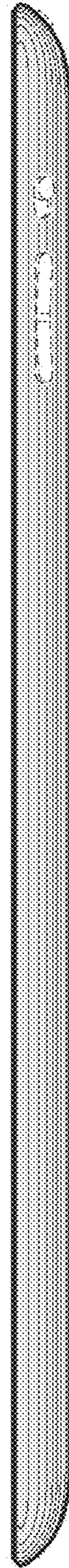

FIG. 6

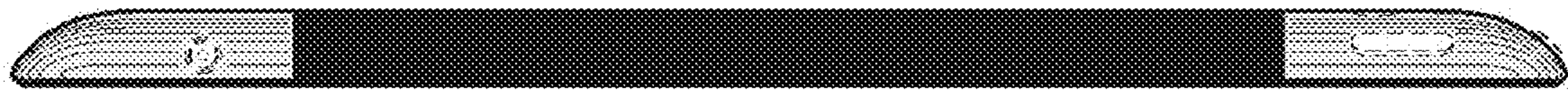

FIG. 7



FIG. 8

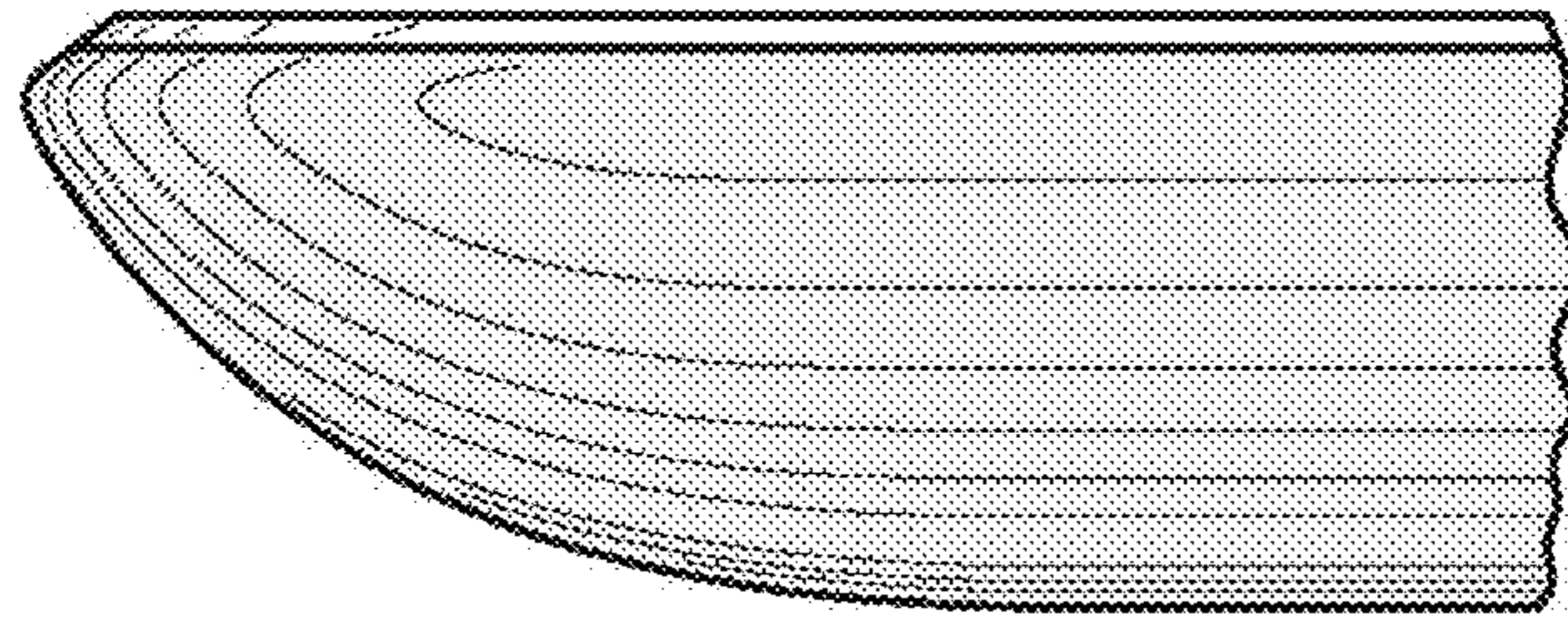

FIG. 9

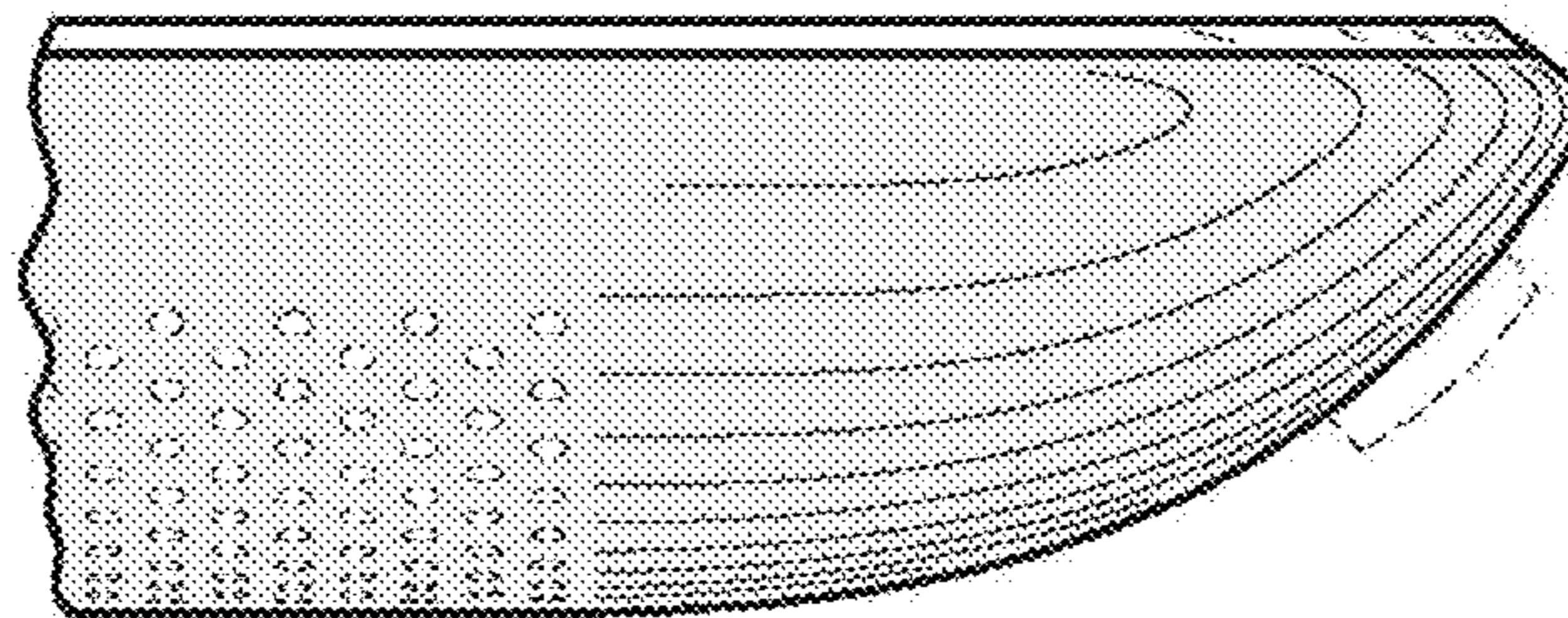

FIG. 10

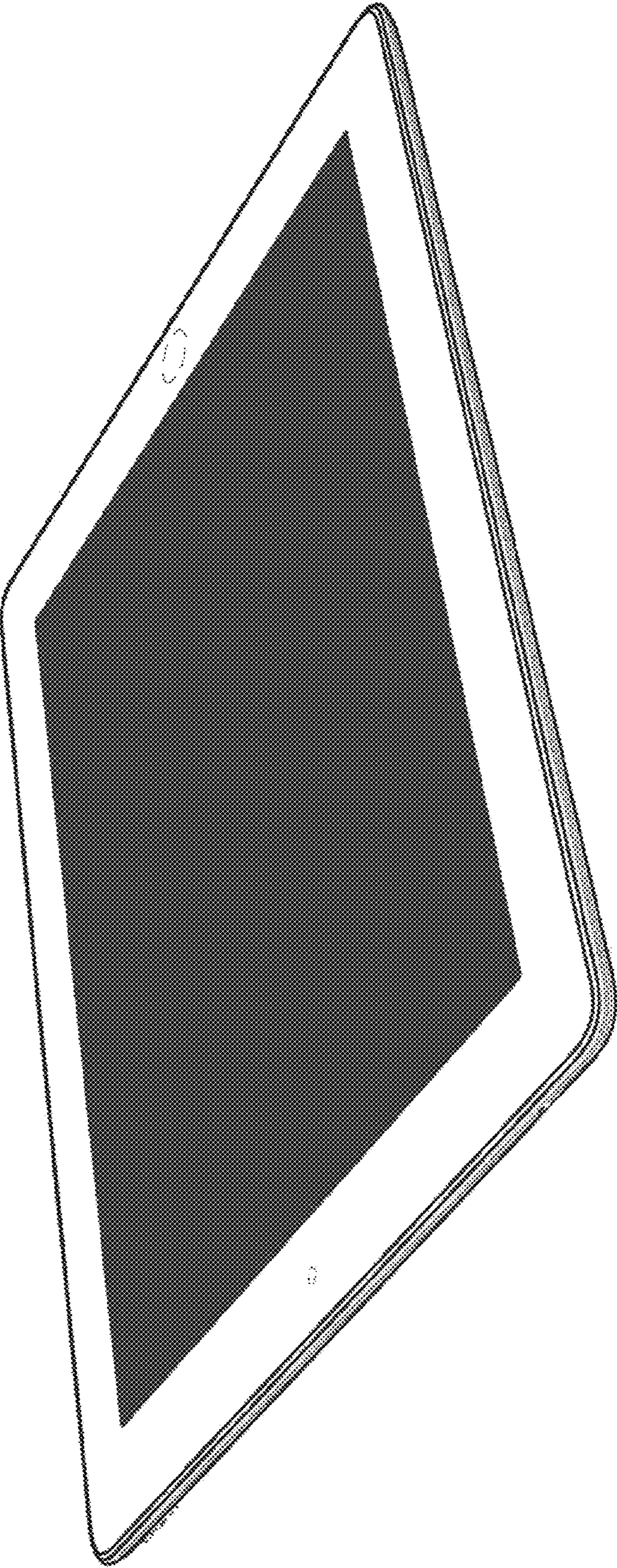

FIG. 11

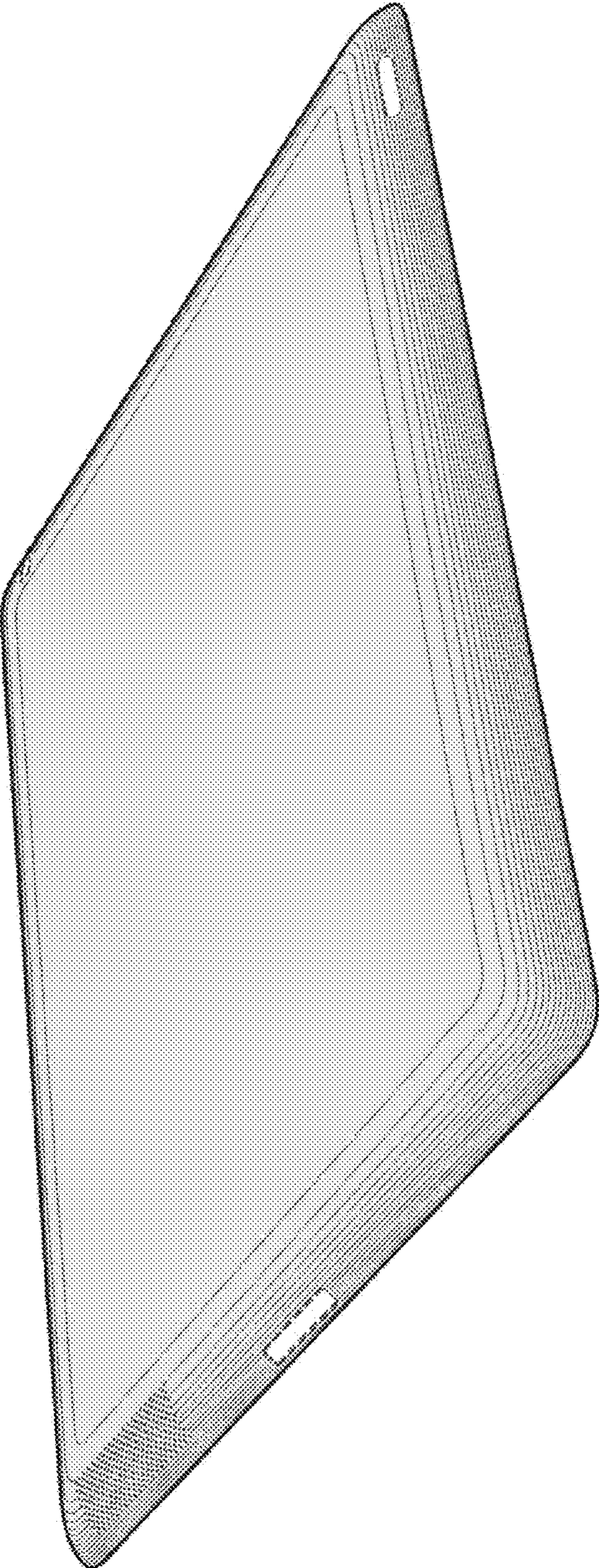

FIG. 12

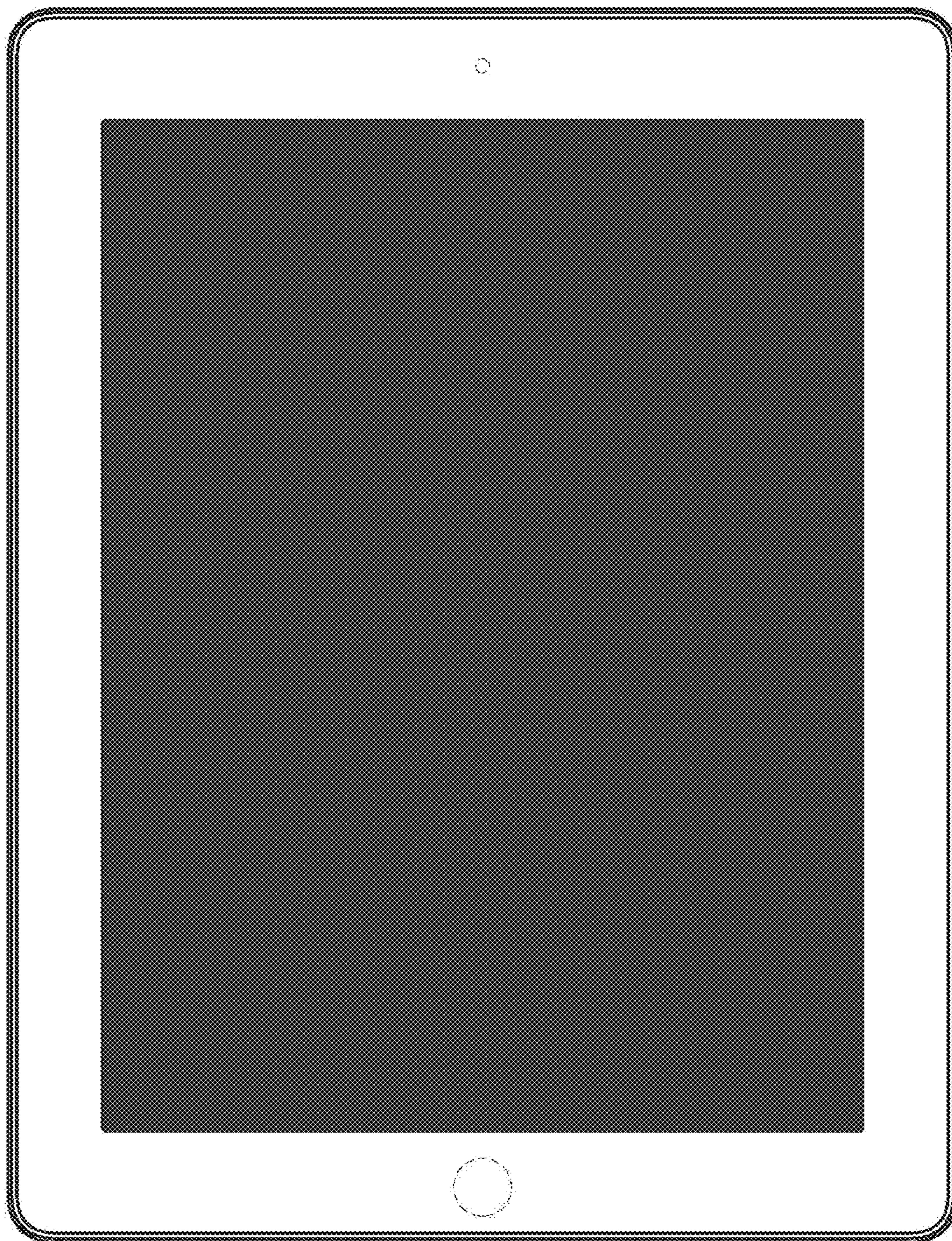

FIG. 13

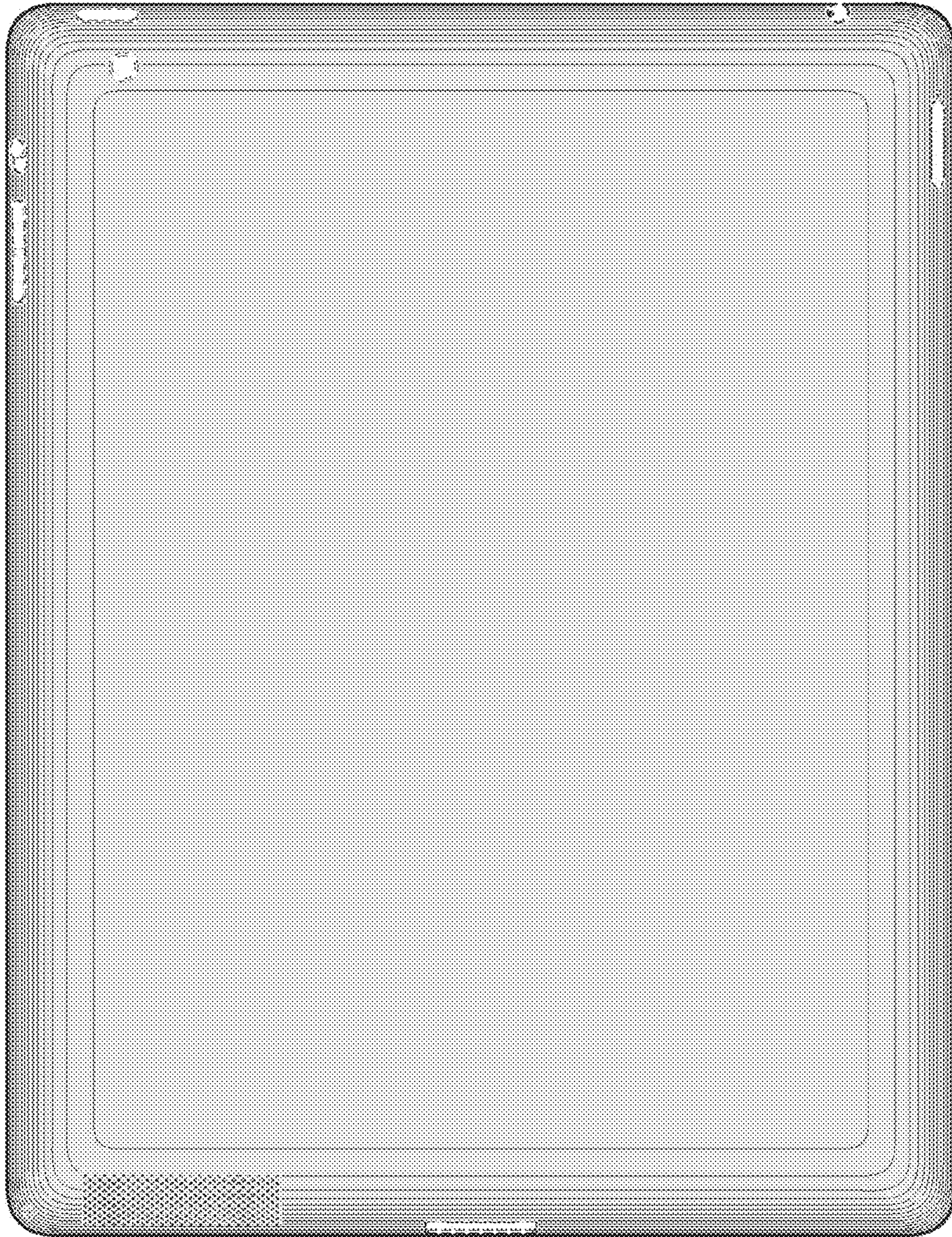

FIG. 14

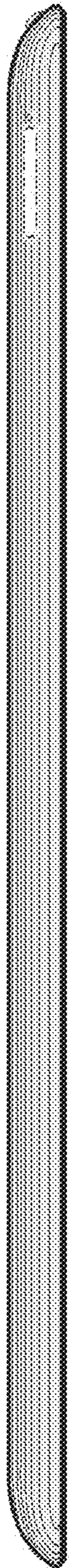

FIG. 15

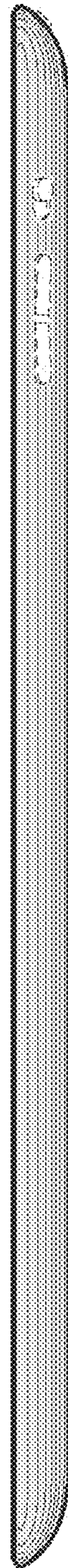

FIG. 16

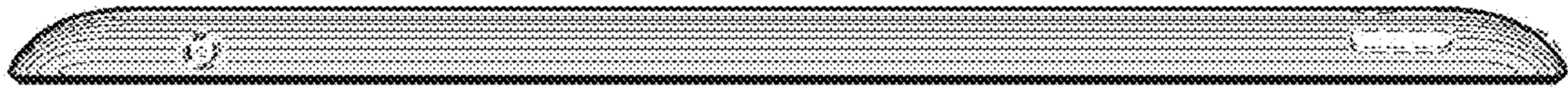

FIG. 17

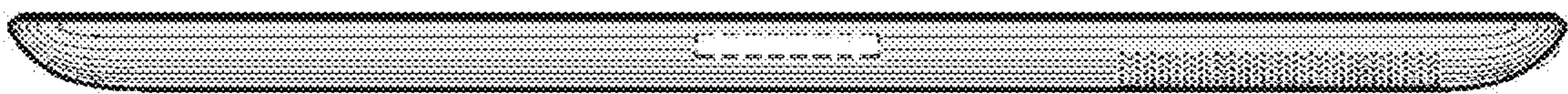

FIG. 18

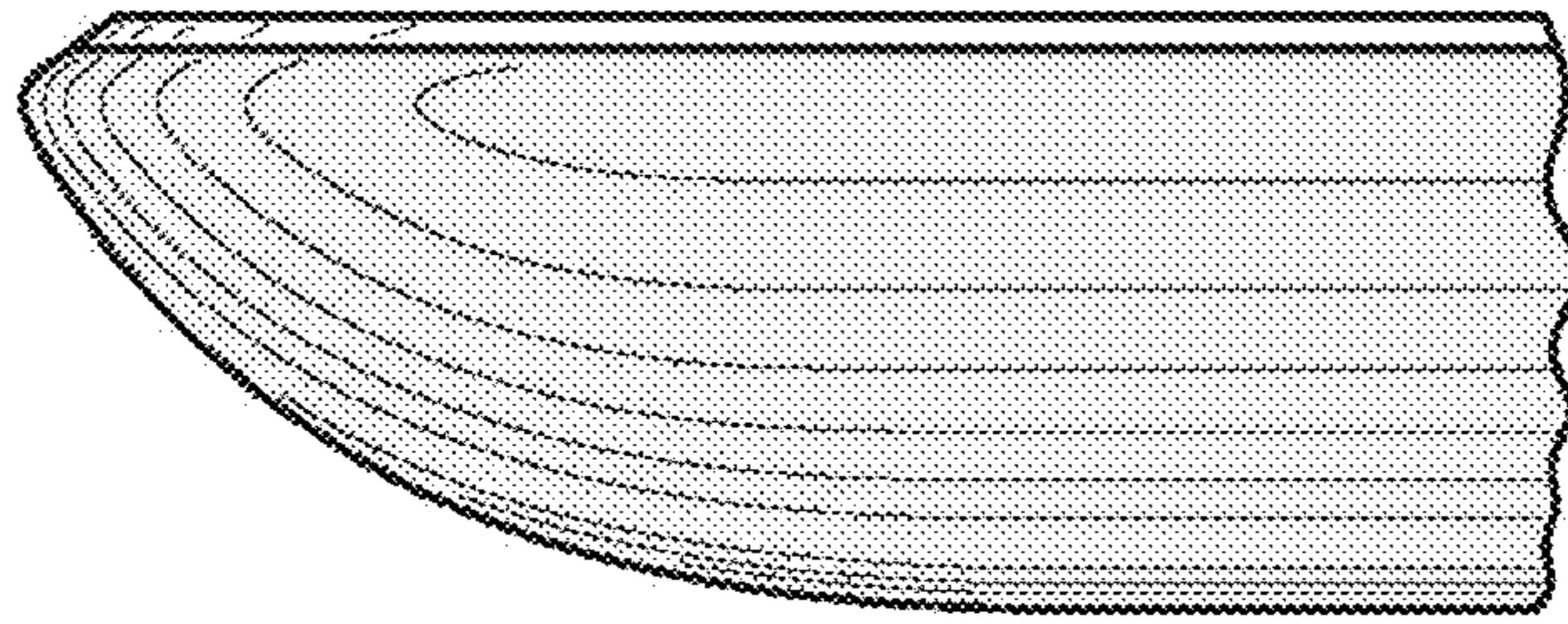

FIG. 19

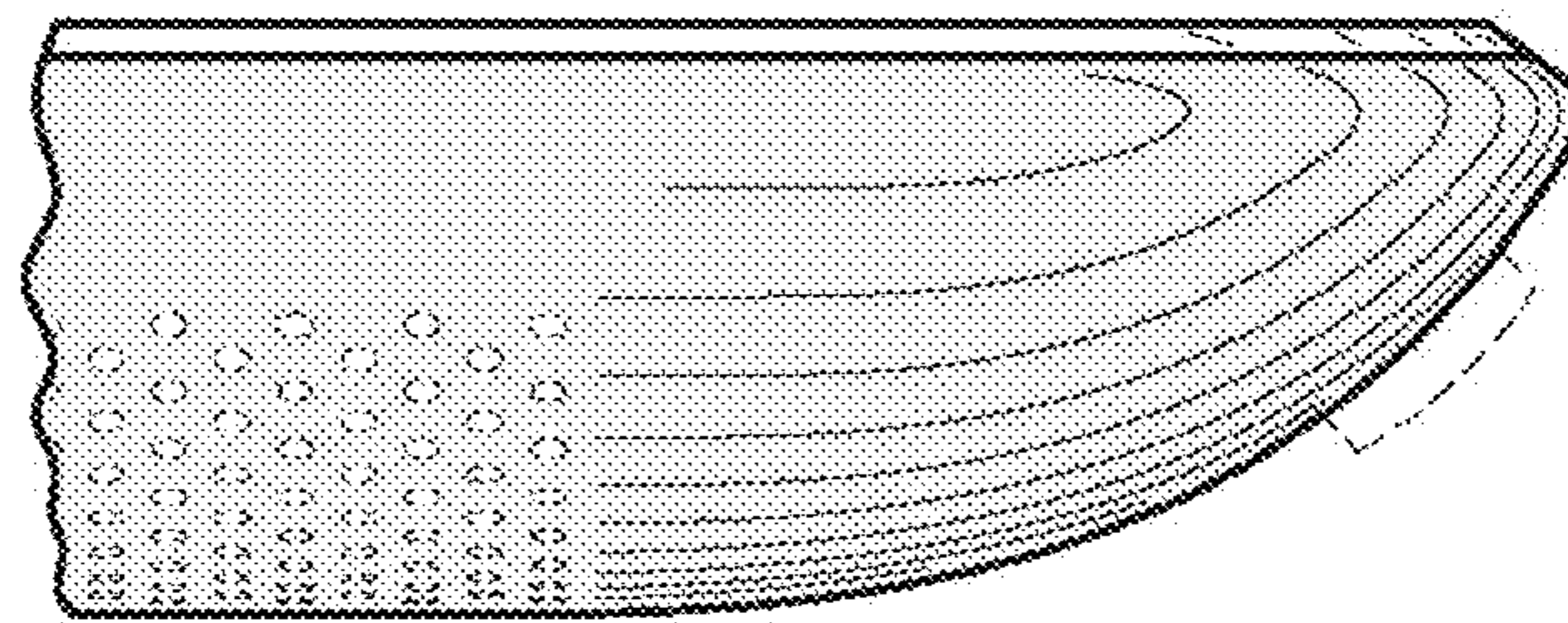

FIG. 20

UNITED STATES PATENT AND TRADEMARK OFFICE
CERTIFICATE OF CORRECTION

PATENT NO. : D699,719 S
APPLICATION NO. : 29/437117
DATED : February 18, 2014
INVENTOR(S) : Jody Akana et al.

Page 1 of 1

It is certified that error appears in the above-identified patent and that said Letters Patent is hereby corrected as shown below:

On title page 10, in the description, lines 13-14, amend "FIG. 15 is a right side view thereof" to --FIG. 15 is a left side view thereof-- and "FIG. 16 is a left side view thereof" to --FIG. 16 is a right side view thereof--.

Signed and Sealed this
Third Day of June, 2014



Michelle K. Lee
Deputy Director of the United States Patent and Trademark Office