

US00D699662S

(12) **United States Design Patent**
Aruga

(10) **Patent No.:** **US D699,662 S**

(45) **Date of Patent:** **** Feb. 18, 2014**

(54) **JOINT FOR AIRCRAFT LUGGAGE COMPARTMENTS**

(75) Inventor: **Hiroyasu Aruga**, Tokyo (JP)

(73) Assignee: **Mitsubishi Aircraft Corporation**,
Aichi-Ken (JP)

(**) Term: **14 Years**

(21) Appl. No.: **29/432,235**

(22) Filed: **Sep. 14, 2012**

(30) **Foreign Application Priority Data**

Mar. 21, 2012 (JP) 2012-006336

(51) **LOC (10) Cl.** **12-07**

(52) **U.S. Cl.**
USPC **D12/345**

(58) **Field of Classification Search**

USPC D12/319, 345, 415, 418, 423, 424;
244/117 R, 118.1, 118.5, 118.6, 119,
244/137.1; 296/37.7, 37.8; 312/266, 325;
446/7; 362/84

See application file for complete search history.

(56) **References Cited**

U.S. PATENT DOCUMENTS

3,778,011 A * 12/1973 Cannon 244/137.1
D256,229 S * 8/1980 Nichols D12/418
4,927,200 A * 5/1990 Wilkins 296/37.8
D463,357 S * 9/2002 Granzeier et al. D12/345
6,527,325 B2 * 3/2003 Steingrebe et al. 296/37.7
7,234,666 B2 * 6/2007 Novak et al. 244/118.5

D601,937 S * 10/2009 Scoley et al. D12/345
D609,160 S * 2/2010 Wilczynski et al. D12/345
8,047,468 B2 * 11/2011 Schmitz et al. 244/118.1
2001/0011692 A1 * 8/2001 Sprenger et al. 244/118.5
2005/0040287 A1 * 2/2005 Stephan et al. 244/118.5
2007/0084966 A1 * 4/2007 Haynes et al. 244/118.1
2008/0191093 A1 * 8/2008 Benkart et al. 244/118.1
2011/0253837 A1 * 10/2011 Lee et al. 244/118.5
2012/0228426 A1 * 9/2012 Schneider et al. 244/118.5
2012/0273615 A1 * 11/2012 Rafler 244/118.5

* cited by examiner

Primary Examiner — Caron D Veynar

Assistant Examiner — Martie K Holtje

(74) *Attorney, Agent, or Firm* — Birch, Stewart, Kolasch & Birch, LLP

(57) **CLAIM**

The ornamental design for a joint for aircraft luggage compartments, as shown and described.

DESCRIPTION

FIG. 1 is a perspective view from the right side of a joint for aircraft luggage compartments.

FIG. 2 is a perspective view from the left side thereof.

FIG. 3 is a front elevation view thereof.

FIG. 4 is a rear elevation view thereof.

FIG. 5 is a right side elevation view thereof.

FIG. 6 is a left side elevation view thereof.

FIG. 7 is a top plan view thereof.

FIG. 8 is a bottom plan view thereof; and,

FIG. 9 is a referential view showing use thereof.

The portions shown in broken lines are for the purpose of showing environmental structure only and form no part of the claimed design.

1 Claim, 9 Drawing Sheets

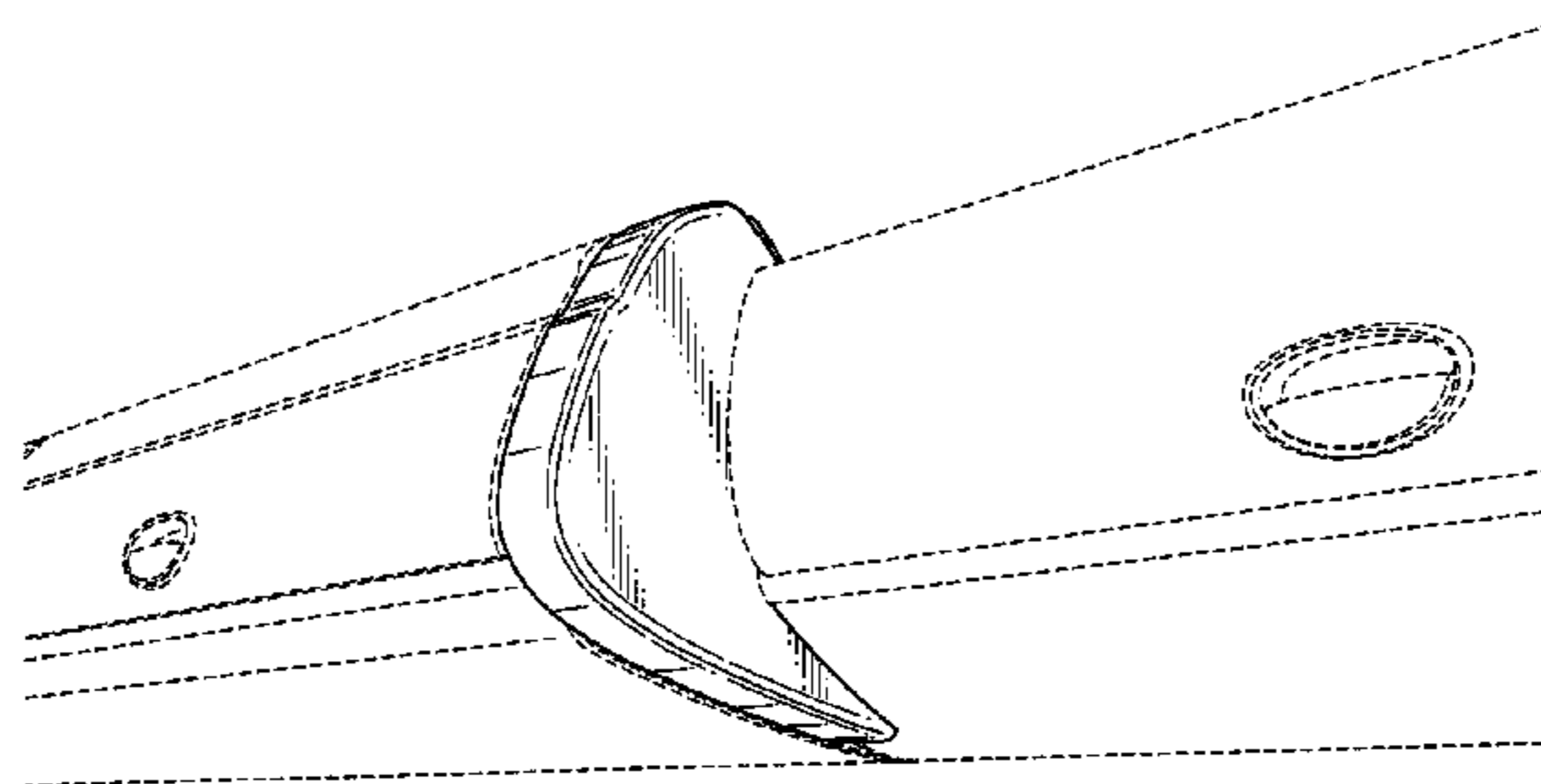
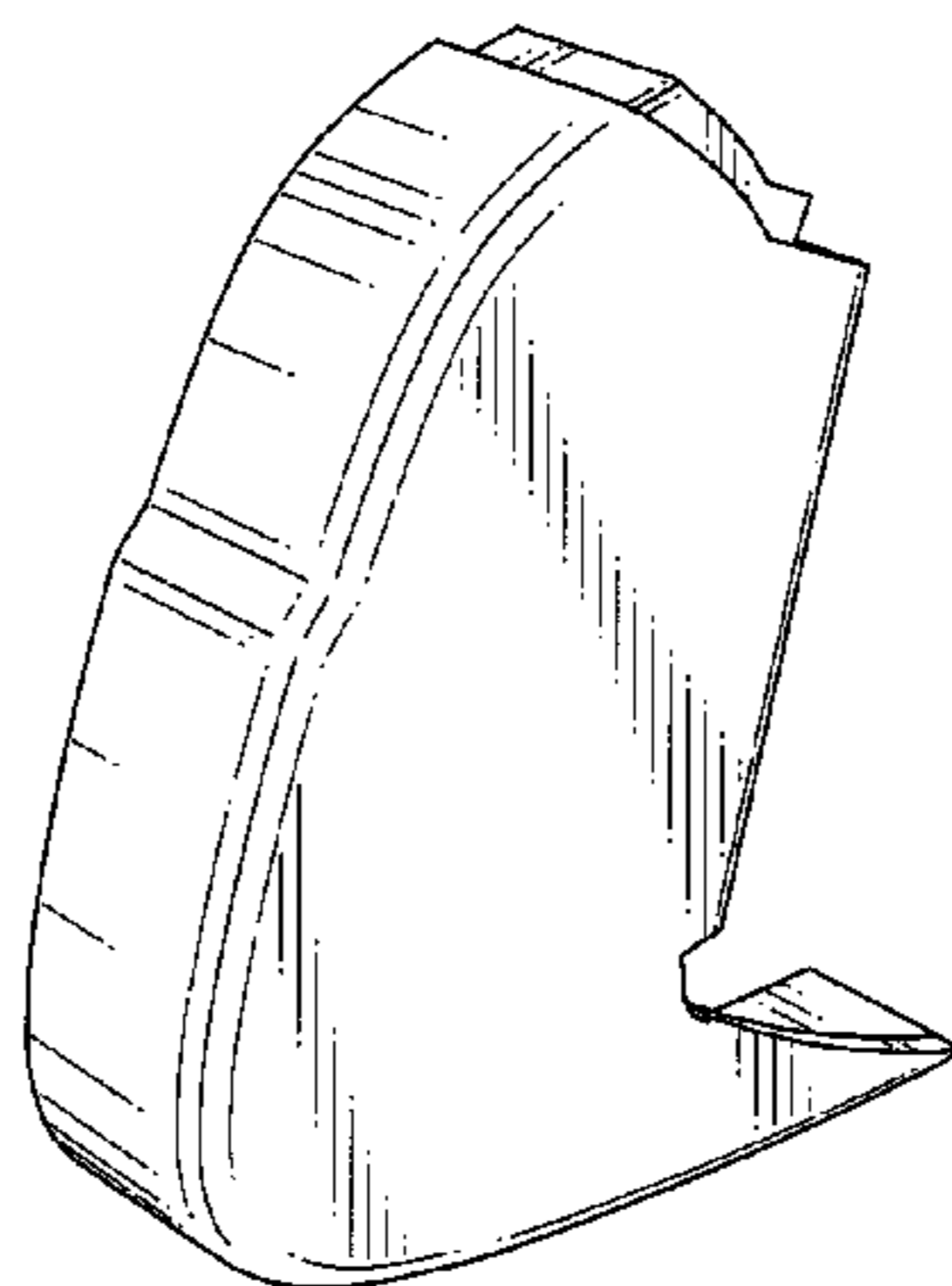

FIG. 1

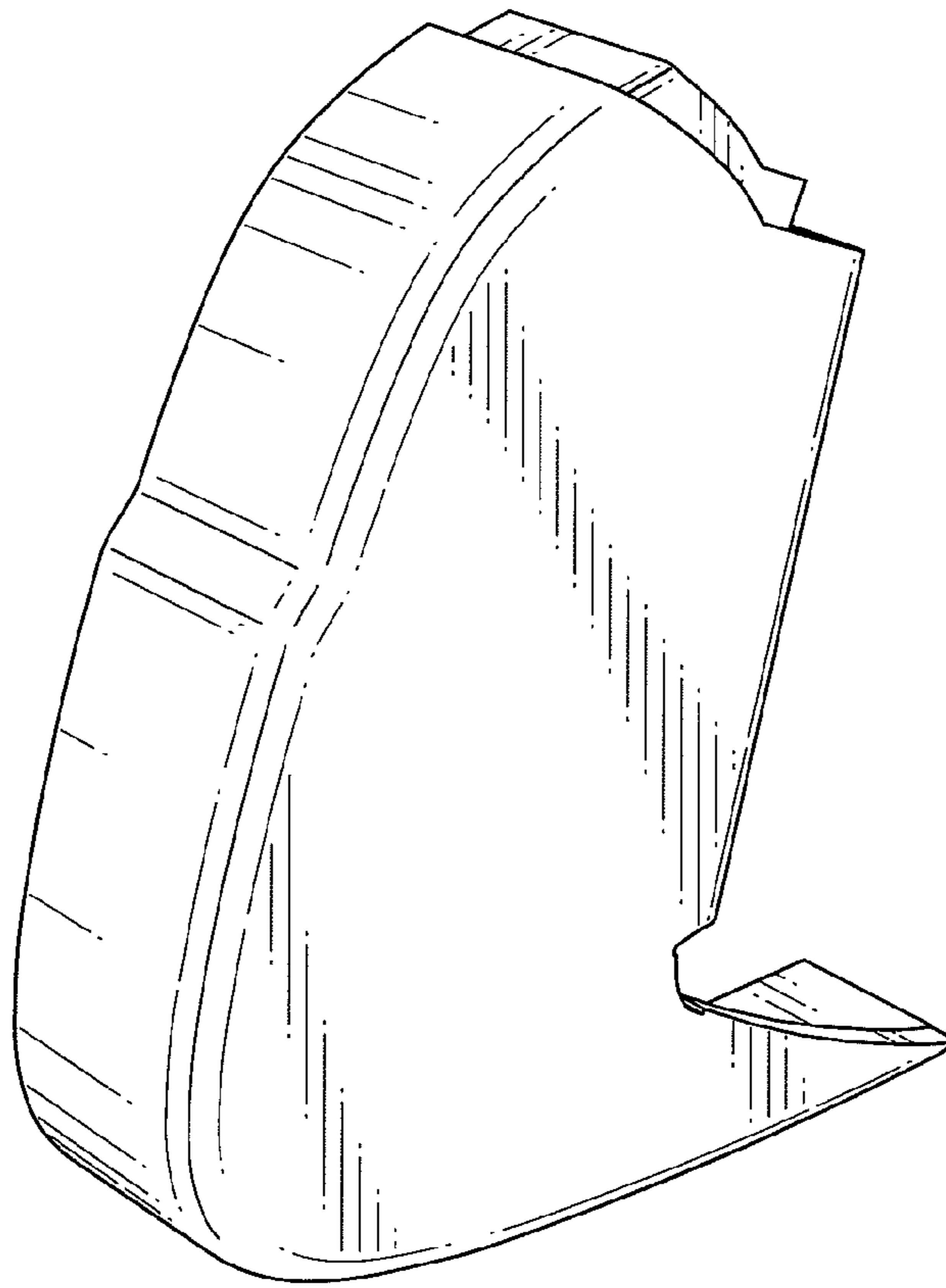

FIG. 2

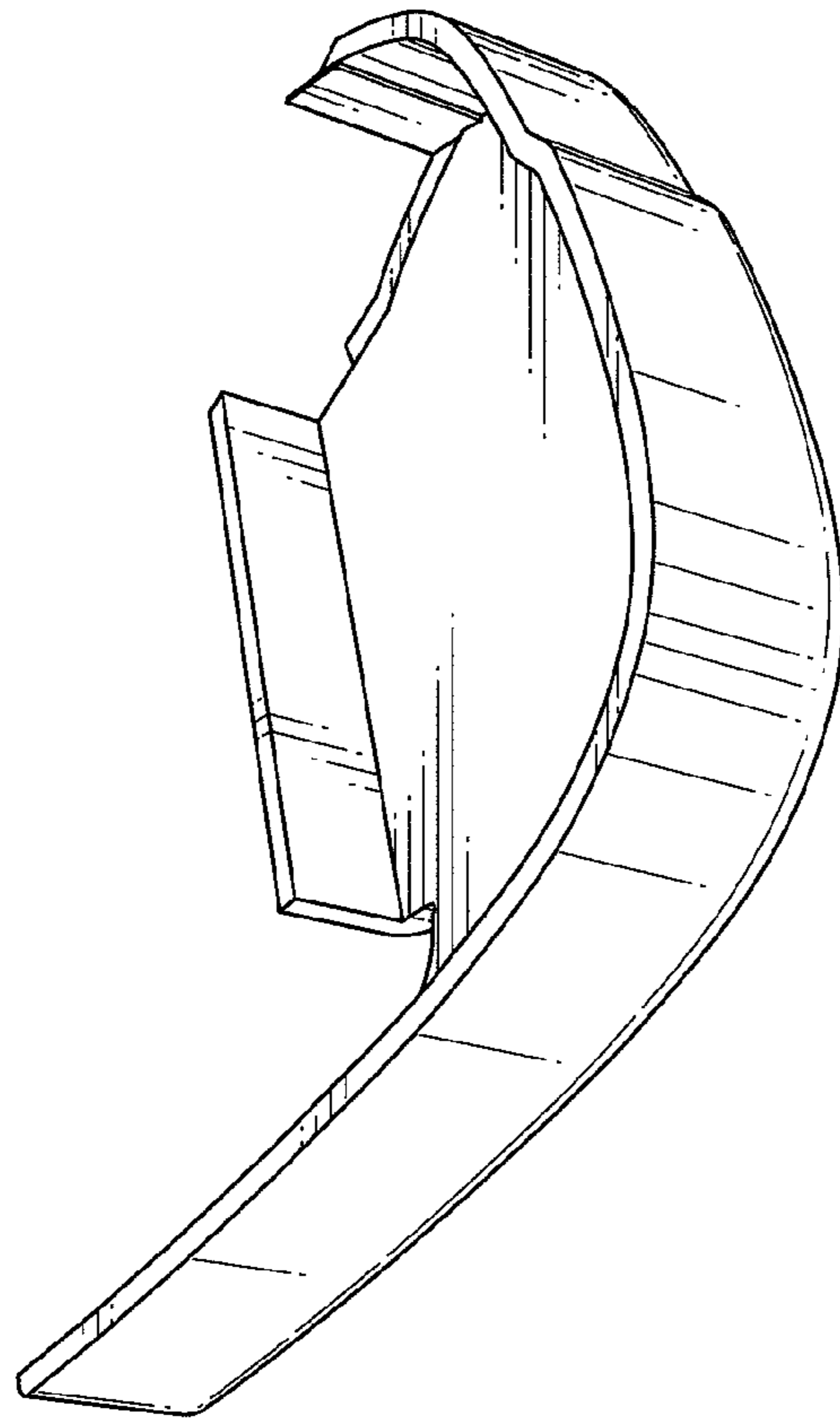

FIG. 3

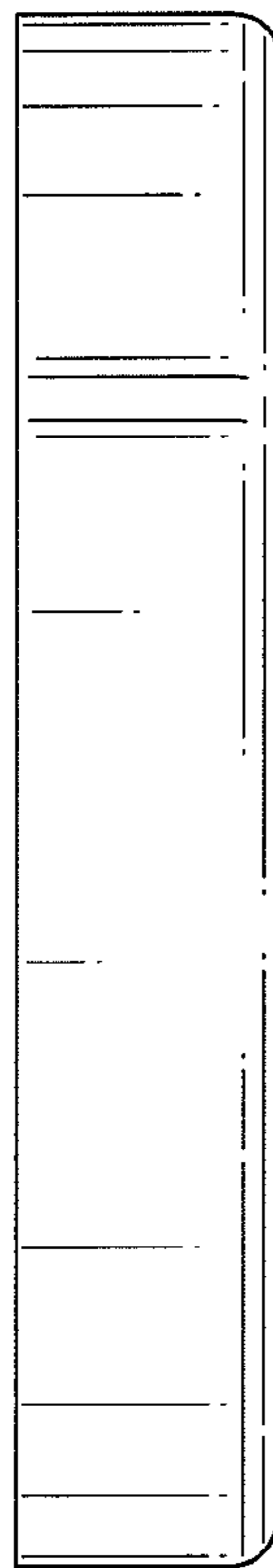

FIG. 4

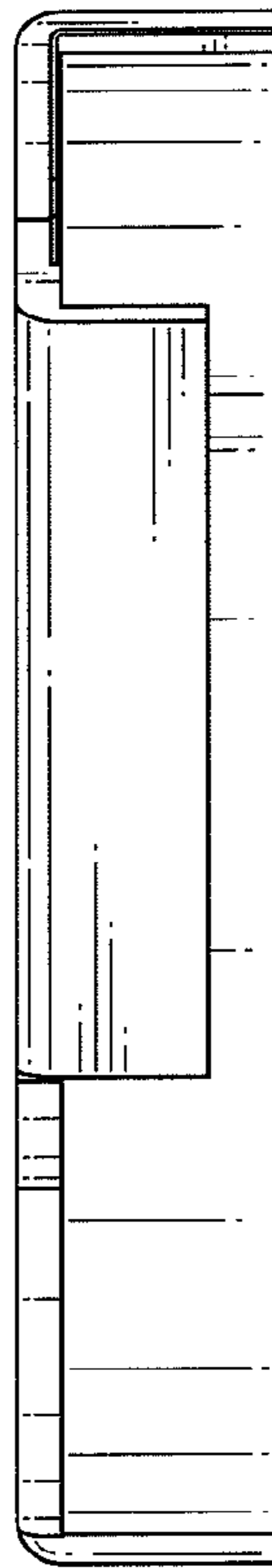

FIG. 5

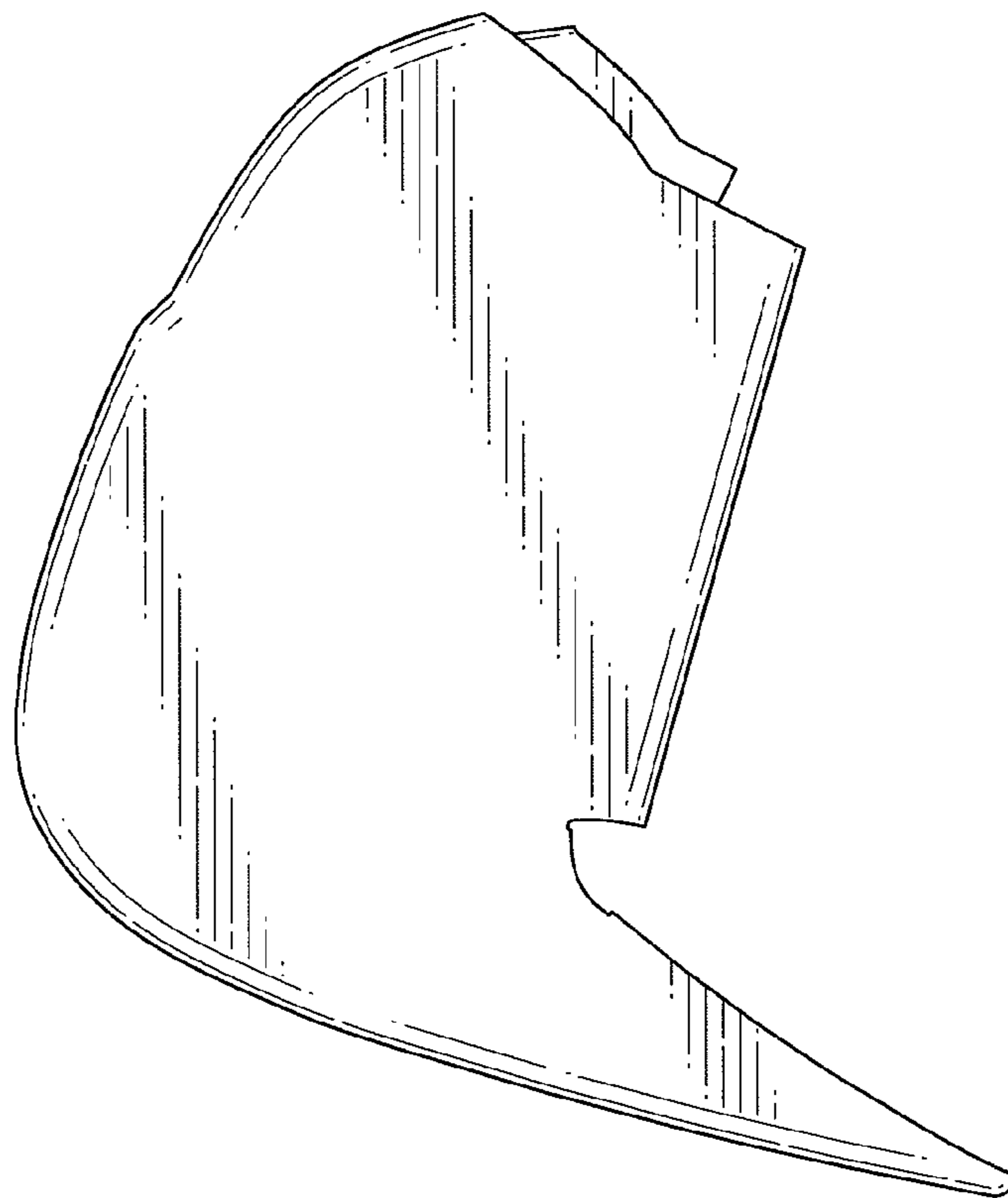

FIG. 6

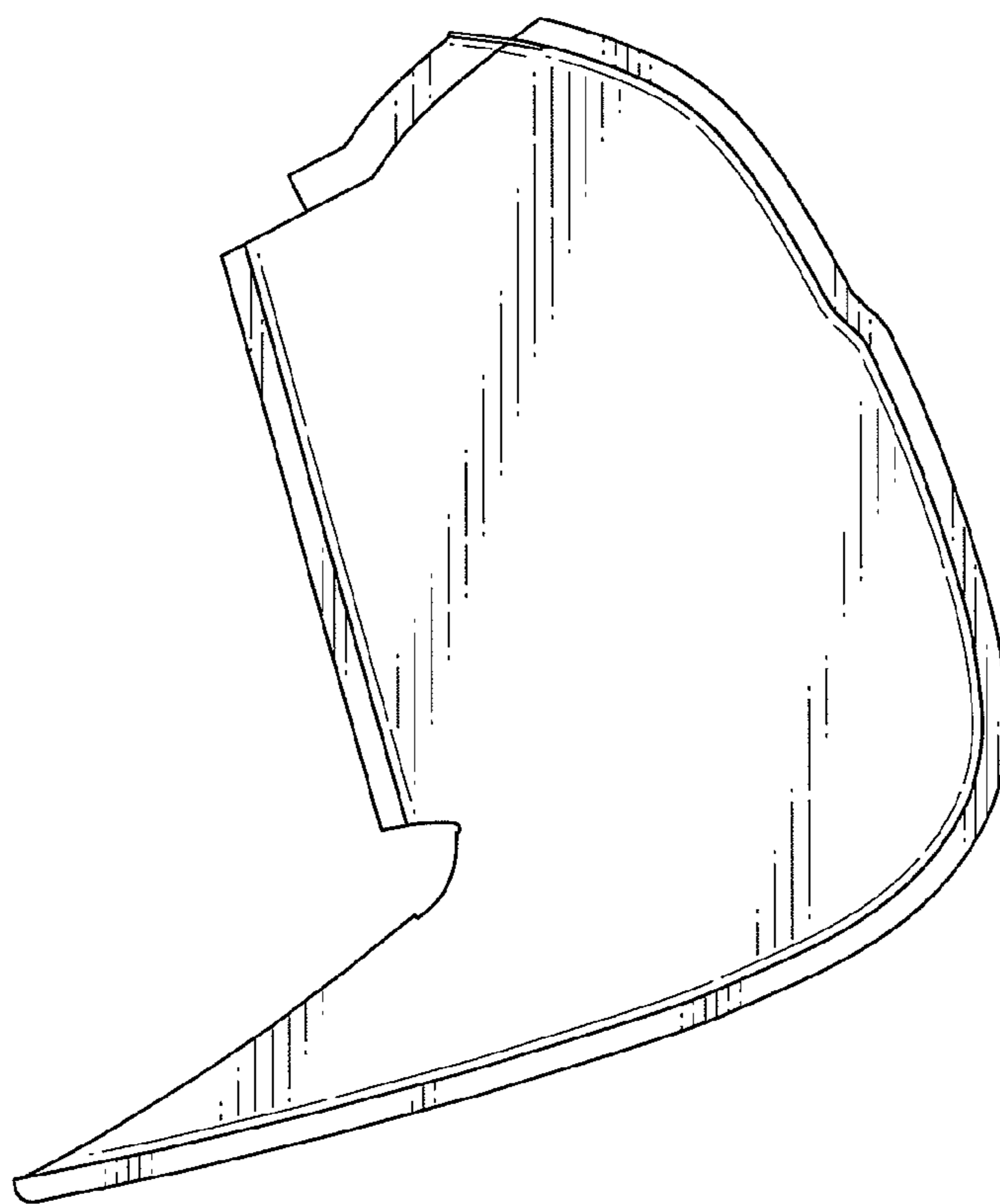

FIG. 7

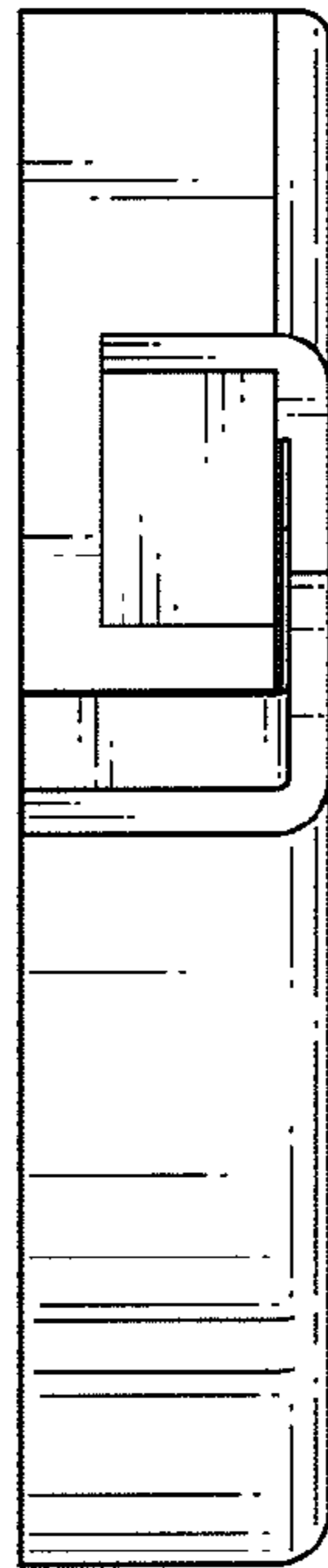

FIG. 8

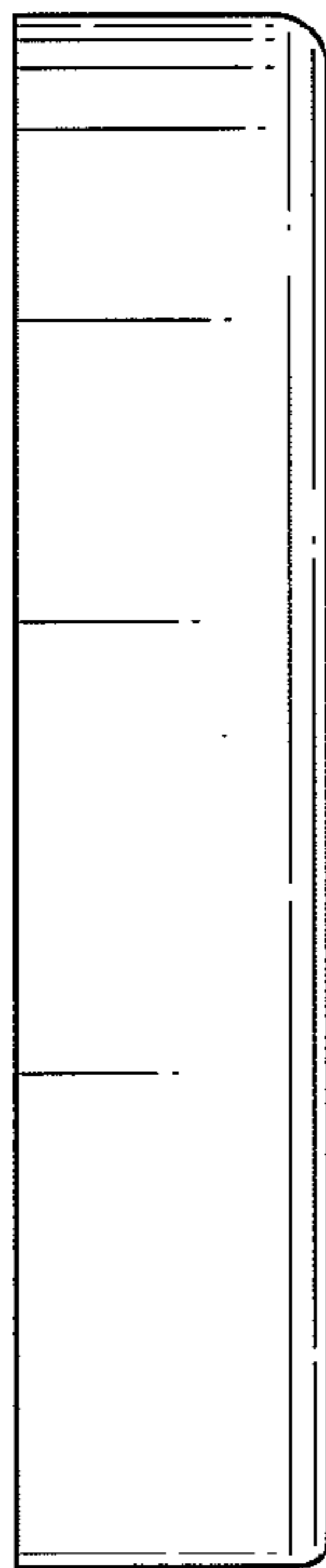

FIG. 9

