



US00D699656S

(12) **United States Design Patent**
Watabe

(10) **Patent No.:** **US D699,656 S**

(45) **Date of Patent:** **** Feb. 18, 2014**

(54) **DOOR PANEL FOR AN AUTOMOBILE**

(75) Inventor: **Takuya Watabe**, Toyota (JP)

(73) Assignee: **Toyota Jidosha Kabushiki Kaisha** (JP)

(**) Term: **14 Years**

(21) Appl. No.: **29/429,260**

(22) Filed: **Aug. 8, 2012**

(51) **LOC (10) Cl.** **12-16**

(52) **U.S. Cl.**
USPC **D12/196**

(58) **Field of Classification Search**
USPC D12/196, 90-92, 86; 296/181.1, 181.5
See application file for complete search history.

(56) **References Cited**

U.S. PATENT DOCUMENTS

D634,686 S *	3/2011	Matei et al.	D12/164
D643,348 S *	8/2011	Burki et al.	D12/164
D644,975 S *	9/2011	Kumai et al.	D12/196
D647,835 S *	11/2011	Sowa et al.	D12/196
D681,529 S *	5/2013	Minami et al.	D12/196

OTHER PUBLICATIONS

Audi, Audi Q5 Hybrid Quattro, Netcarshow.com, http://www.netcarshow.com/audi/2012-q5_hybrid_quattro/800x600/wallpaper_0d.htm.

* cited by examiner

Primary Examiner — Melody Brown

(74) *Attorney, Agent, or Firm* — SAIDMAN DesignLaw Group

(57) **CLAIM**

The ornamental design for a door panel for an automobile, as shown and described.

DESCRIPTION

FIG. 1 is a front perspective view of a door panel for an automobile showing our new design; FIG. 2 is a front view thereof; FIG. 3 is a rear view thereof; FIG. 4 is a top view thereof; FIG. 5 is a bottom view thereof; FIG. 6 is a right side view thereof; and, FIG. 7 is a left side view thereof.

1 Claim, 4 Drawing Sheets

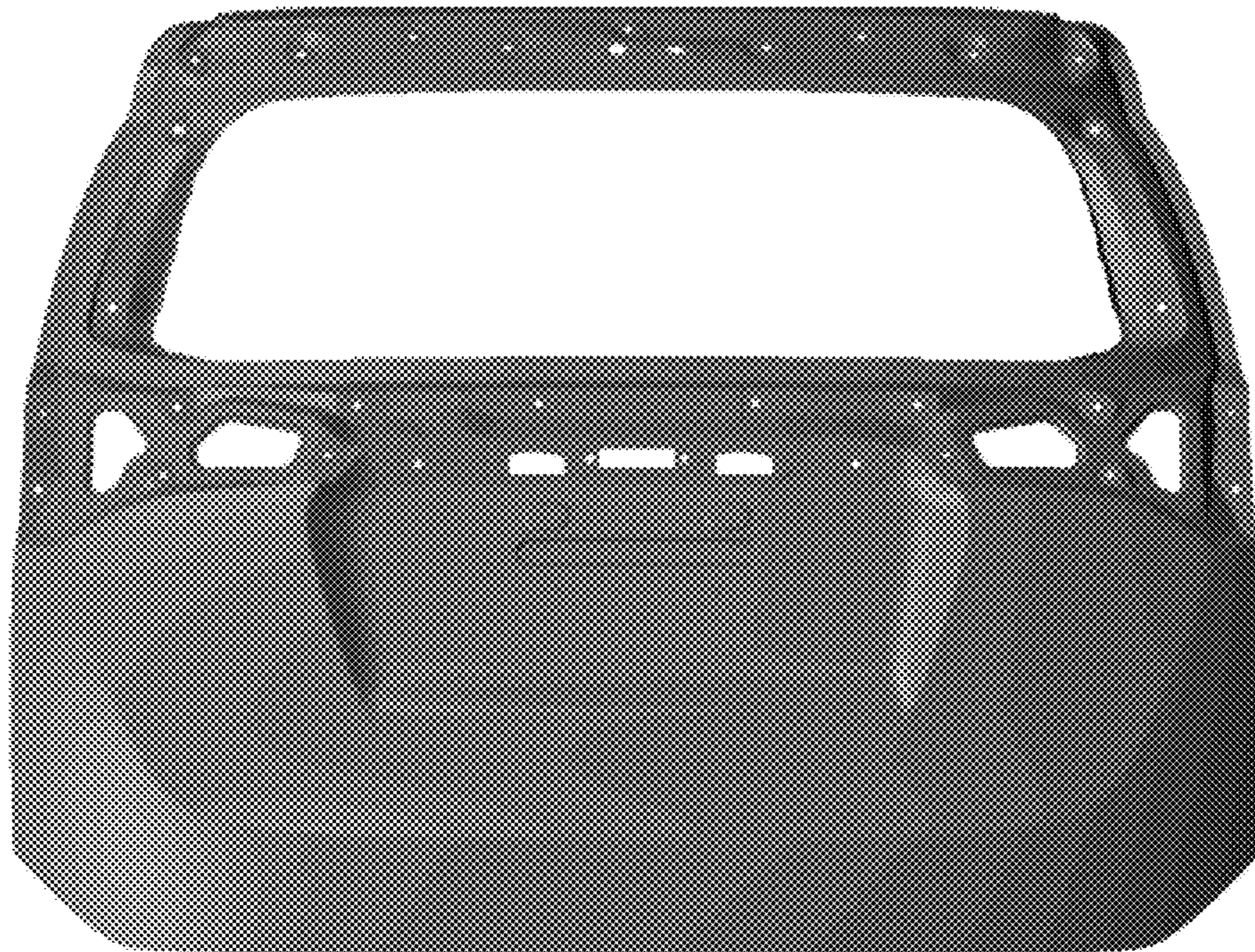



FIG. 1

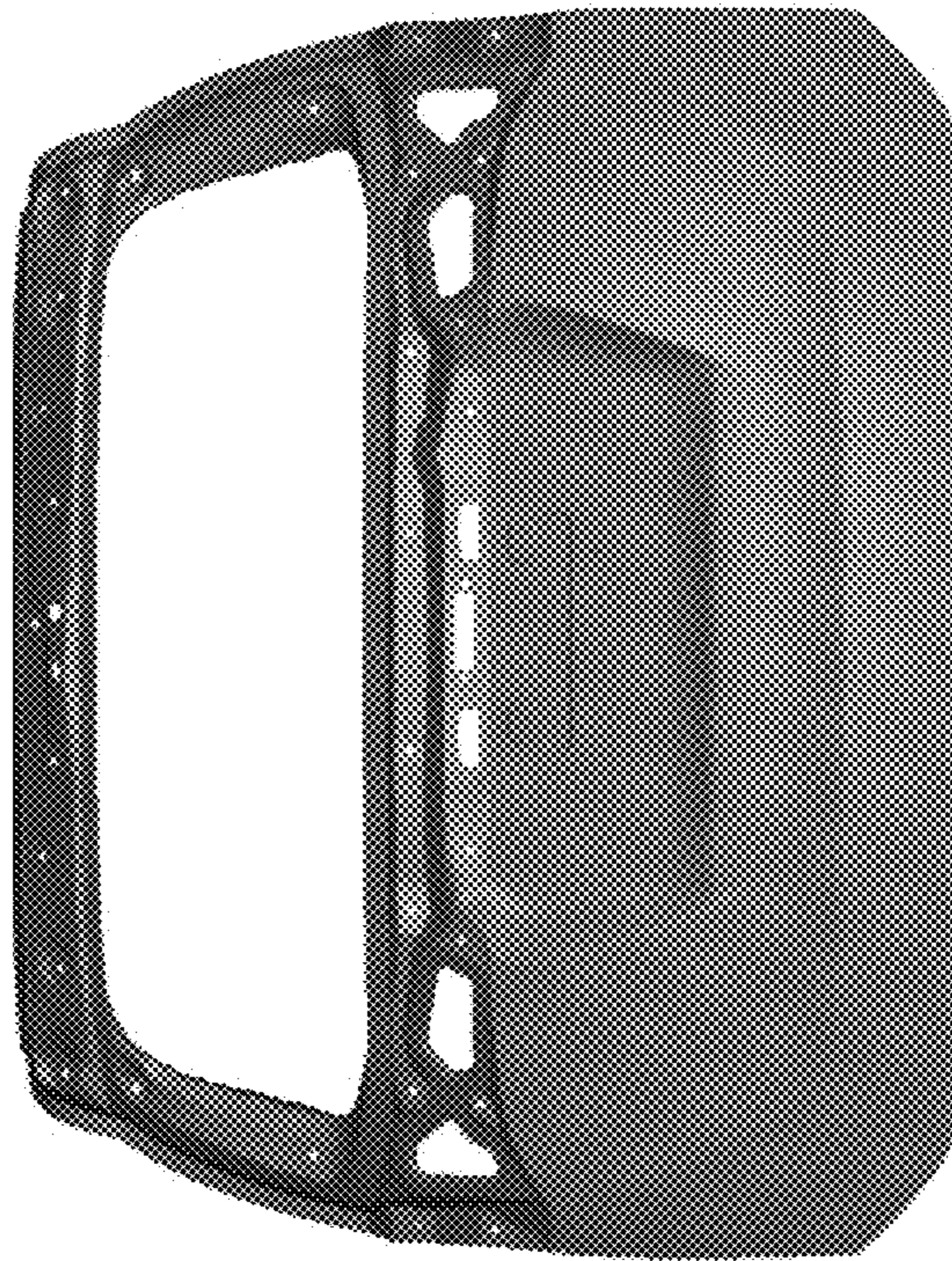

FIG. 2

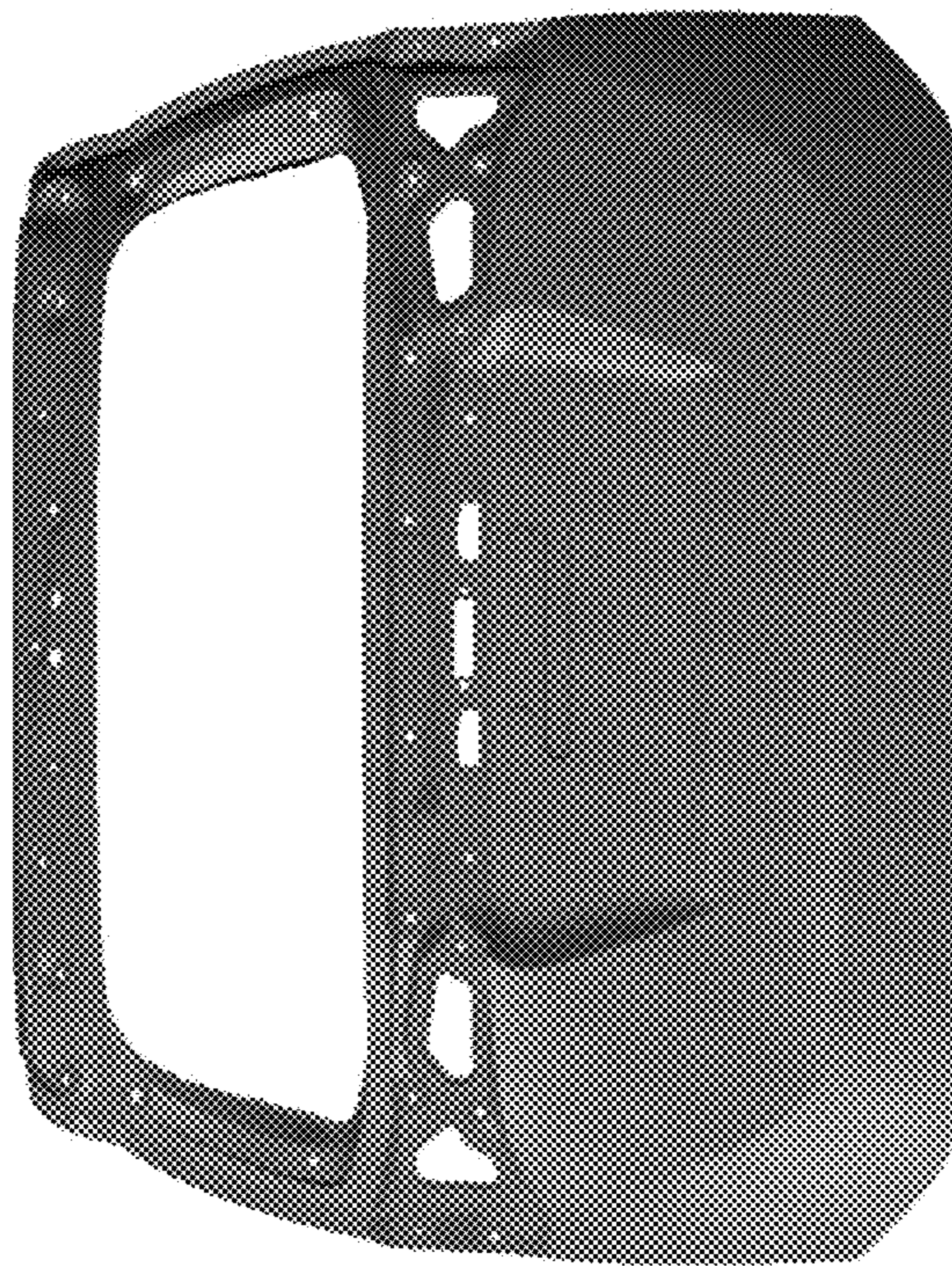

FIG. 3

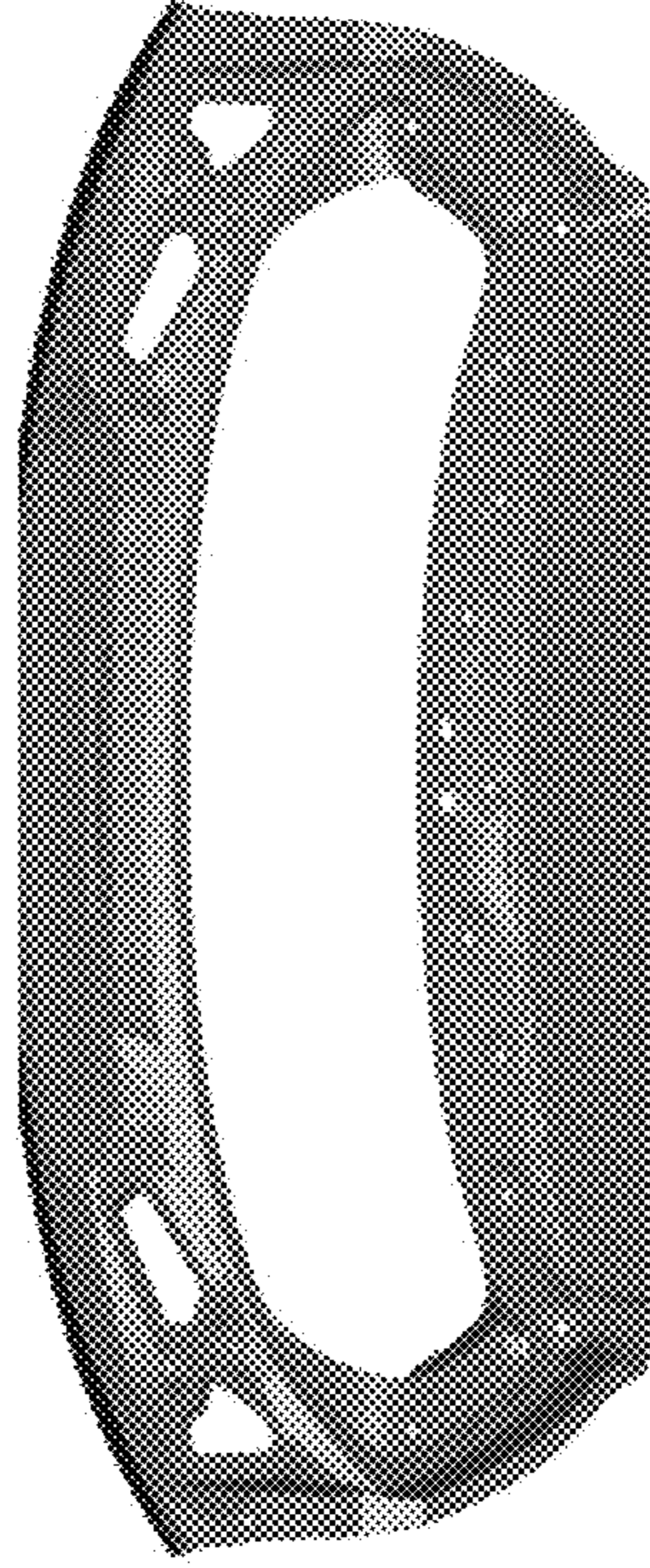

FIG. 4

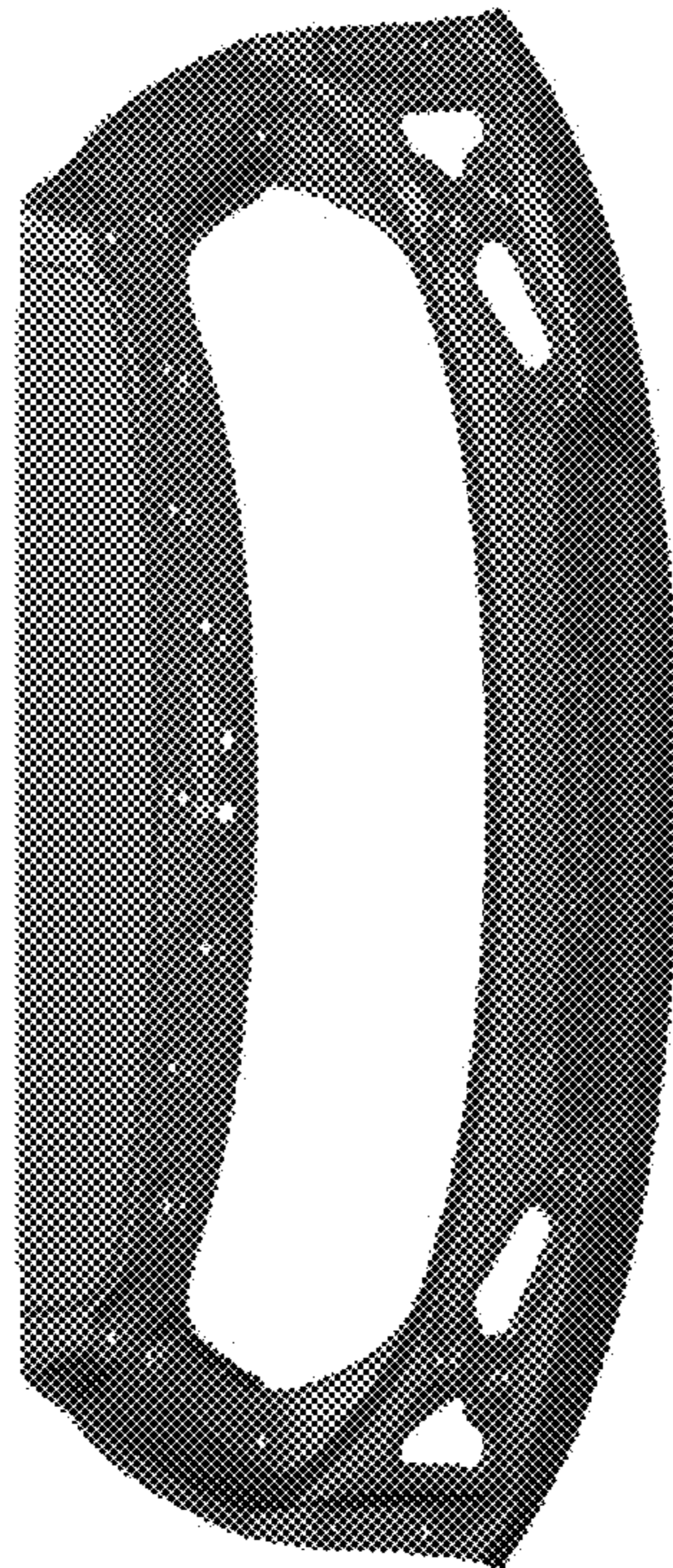

FIG. 5

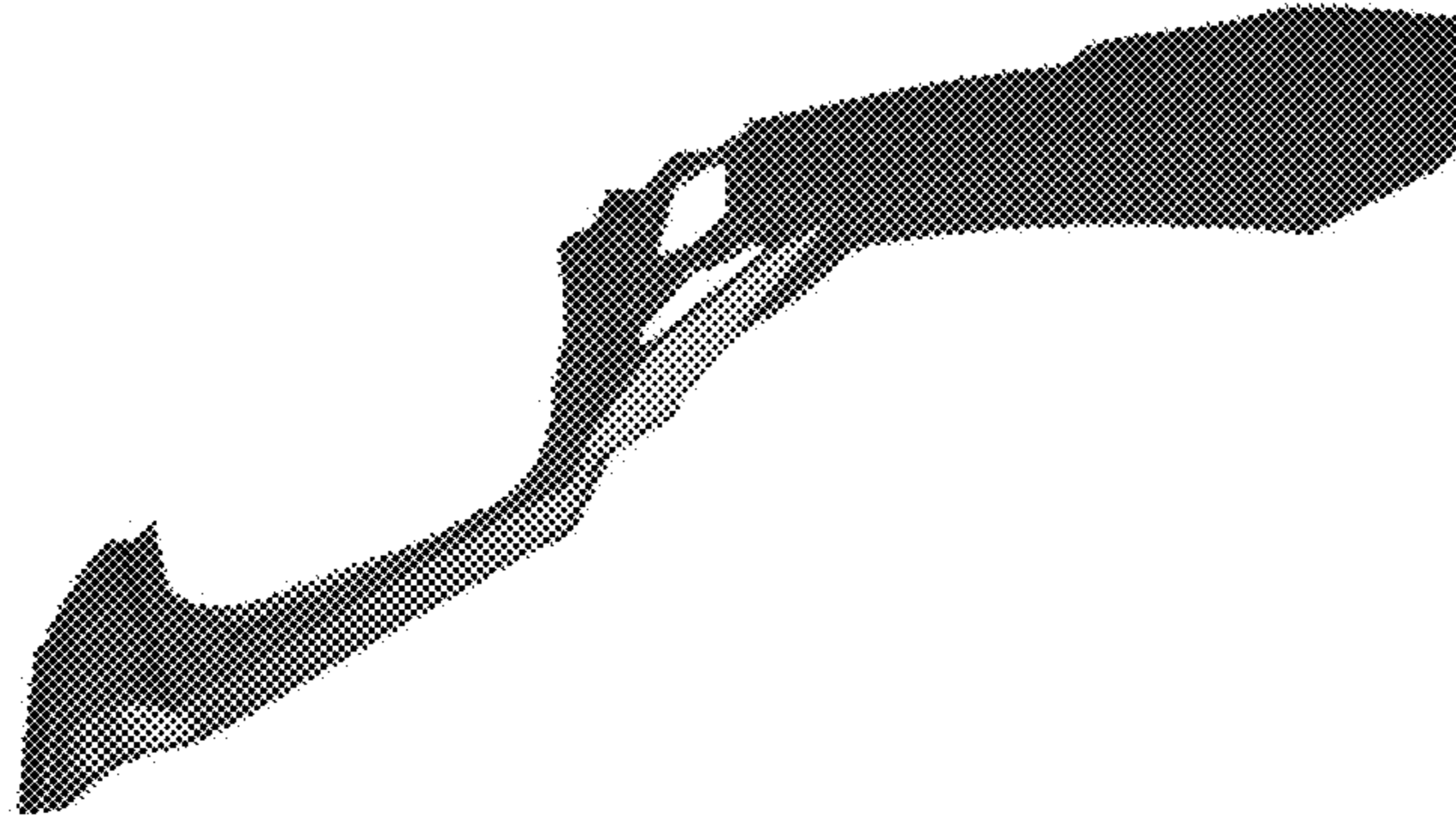

FIG. 7

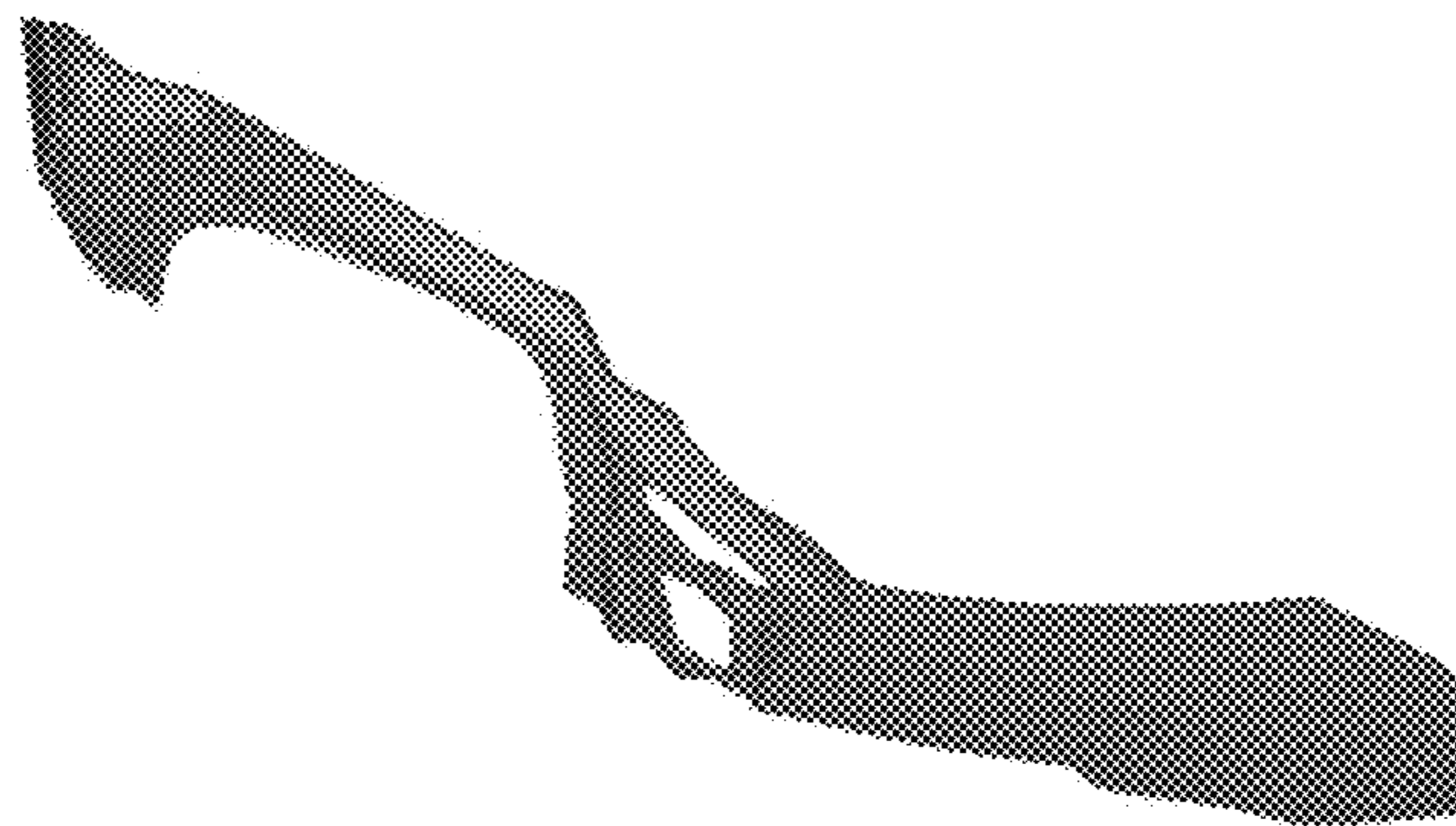

FIG. 6