

US00D699569S

(12) **United States Design Patent**
Doyle

(10) **Patent No.:** **US D699,569 S**

(45) **Date of Patent:** **** Feb. 18, 2014**

(54) **PACKAGE**

(75) Inventor: **Dale Doyle**, Cincinnati, OH (US)

(73) Assignee: **Kraft Foods Global Brands LLC**,
Northfield, IL (US)

(**) Term: **14 Years**

(21) Appl. No.: **29/403,047**

(22) Filed: **Sep. 30, 2011**

(51) **LOC (10) Cl.** **09-03**

(52) **U.S. Cl.**

USPC **D9/432**

(58) **Field of Classification Search**

USPC D9/414, 432, 433, 702; 206/45.21, 100,
206/256, 312, 410, 449, 455, 460, 472, 750,
206/800; 220/6, 7, 9.2; 229/87.08, 87.01,
229/87.05, 87.07, 87.13, 120.09, 120.18

See application file for complete search history.

(56) **References Cited**

U.S. PATENT DOCUMENTS

437,042	A *	9/1890	Allen	229/120.09
1,688,699	A *	10/1928	Gardner, Jr.	206/256
1,805,371	A *	5/1931	Molins	206/256
1,842,891	A *	1/1932	Allen	221/103
1,863,190	A *	6/1932	Coulapides	206/256
2,192,472	A *	3/1940	Huston	426/5
2,192,473	A *	3/1940	Huston	206/472
2,320,018	A *	5/1943	Ullman	229/120.18
3,769,741	A *	11/1973	Hessler et al.	43/57.1
5,201,413	A *	4/1993	DeBlasio et al.	206/256
D454,303	S *	3/2002	Sipinen	D9/702
D531,498	S *	11/2006	Fluegel et al.	D9/432
D585,737	S *	2/2009	Double et al.	D9/432
D608,194	S *	1/2010	Gajardo	D9/433
D639,014	S *	5/2011	Eustis	D34/39
2003/0201313	A1 *	10/2003	Dudley	229/68.1
2010/0044263	A1 *	2/2010	Zotter	206/449

OTHER PUBLICATIONS

<http://www.lotteid.com/main.asp> dated Jan. 3, 2012.

* cited by examiner

Primary Examiner — Derrick Holland

Assistant Examiner — Lauren Calve

(74) *Attorney, Agent, or Firm* — Cantor Colburn LLP

(57) **CLAIM**

I claim, the ornamental design for a package, as shown and described.

DESCRIPTION

FIG. 1 is a perspective view of a package, showing our new design in an exemplary embodiment;

FIG. 2 is a front elevation view of the embodiment shown in FIG. 1;

FIG. 3 is a back elevation view of the embodiment shown in FIG. 1;

FIG. 4 is a side elevation view of the embodiment shown in FIG. 1;

FIG. 5 is another side elevation view of the embodiment shown in FIG. 1;

FIG. 6 is a top plan view of the embodiment shown in FIG. 1;

FIG. 7 is a bottom plan view of the embodiment shown in FIG. 1;

FIG. 8 is a perspective view of a package, showing our new design in an exemplary embodiment;

FIG. 9 is a front elevation view of the embodiment shown in FIG. 8;

FIG. 10 is a back elevation view of the embodiment shown in FIG. 8;

FIG. 11 is a side elevation view of the embodiment shown in FIG. 8;

FIG. 12 is another side elevation view of the embodiment shown in FIG. 8;

FIG. 13 is a top plan view of the embodiment shown in FIG. 8; and,

FIG. 14 is a bottom plan view of the embodiment shown in FIG. 8.

The stippling shown in FIGS. 8-14 represents a contrast in appearance.

1 Claim, 4 Drawing Sheets

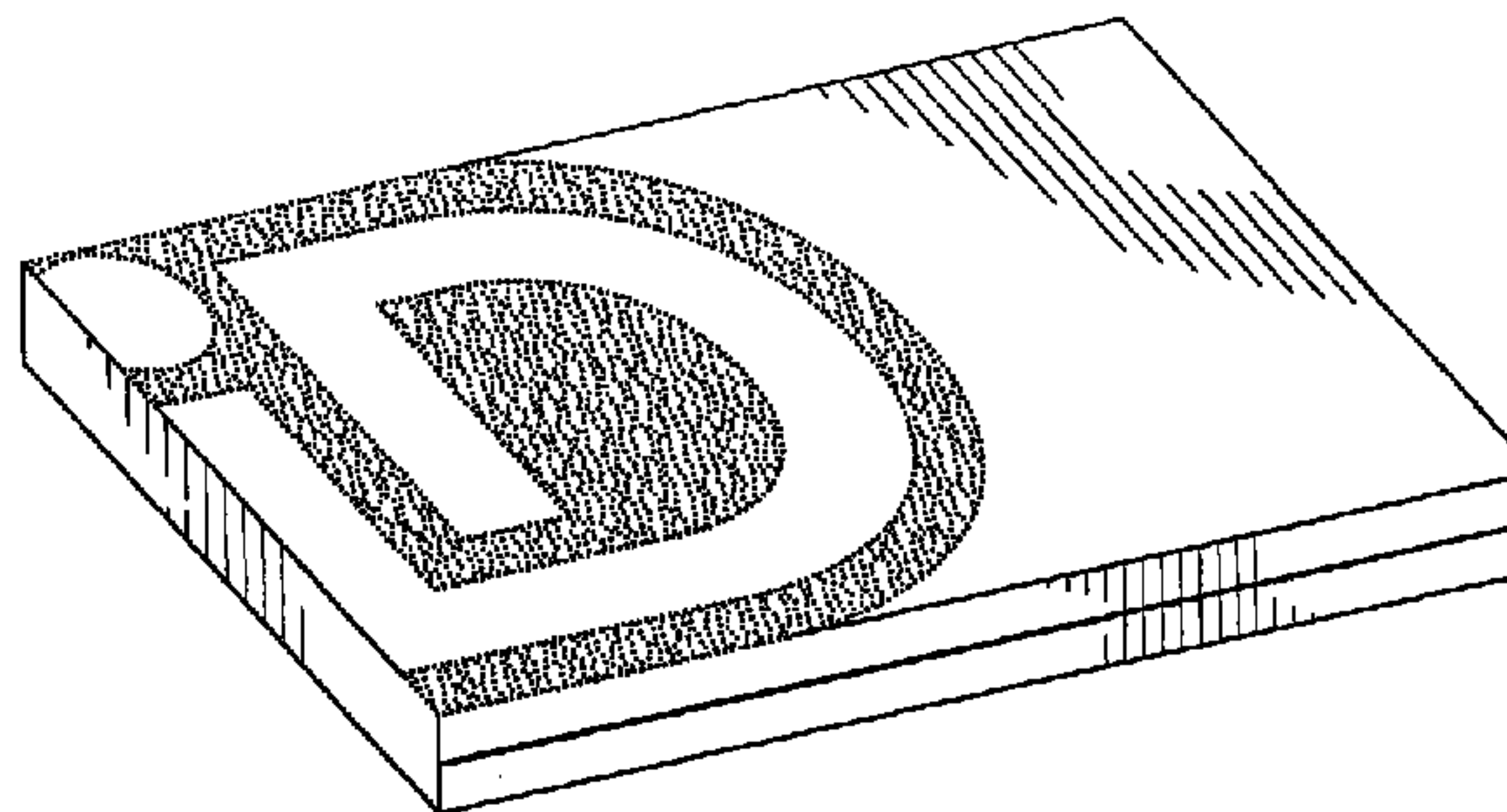
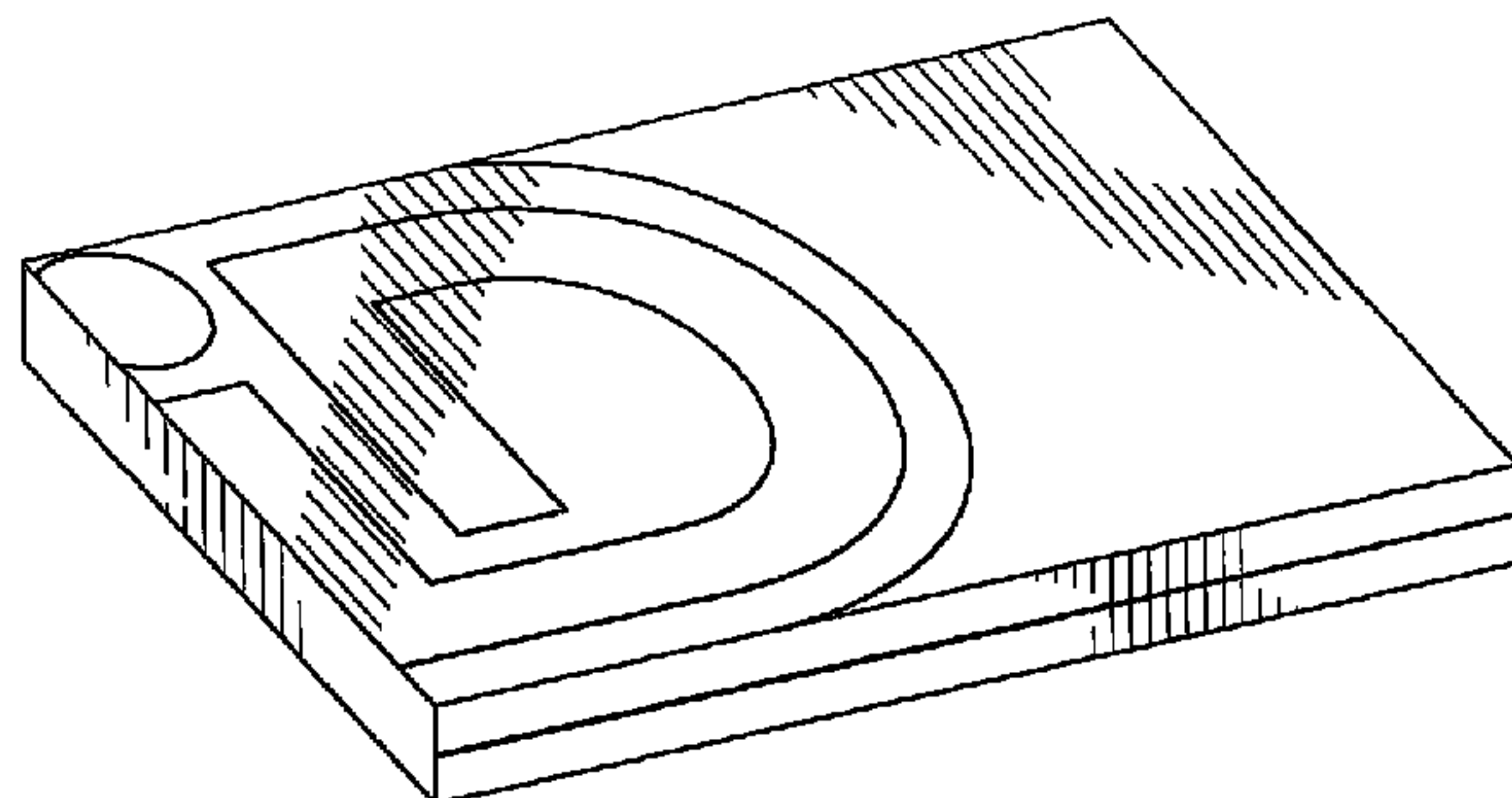

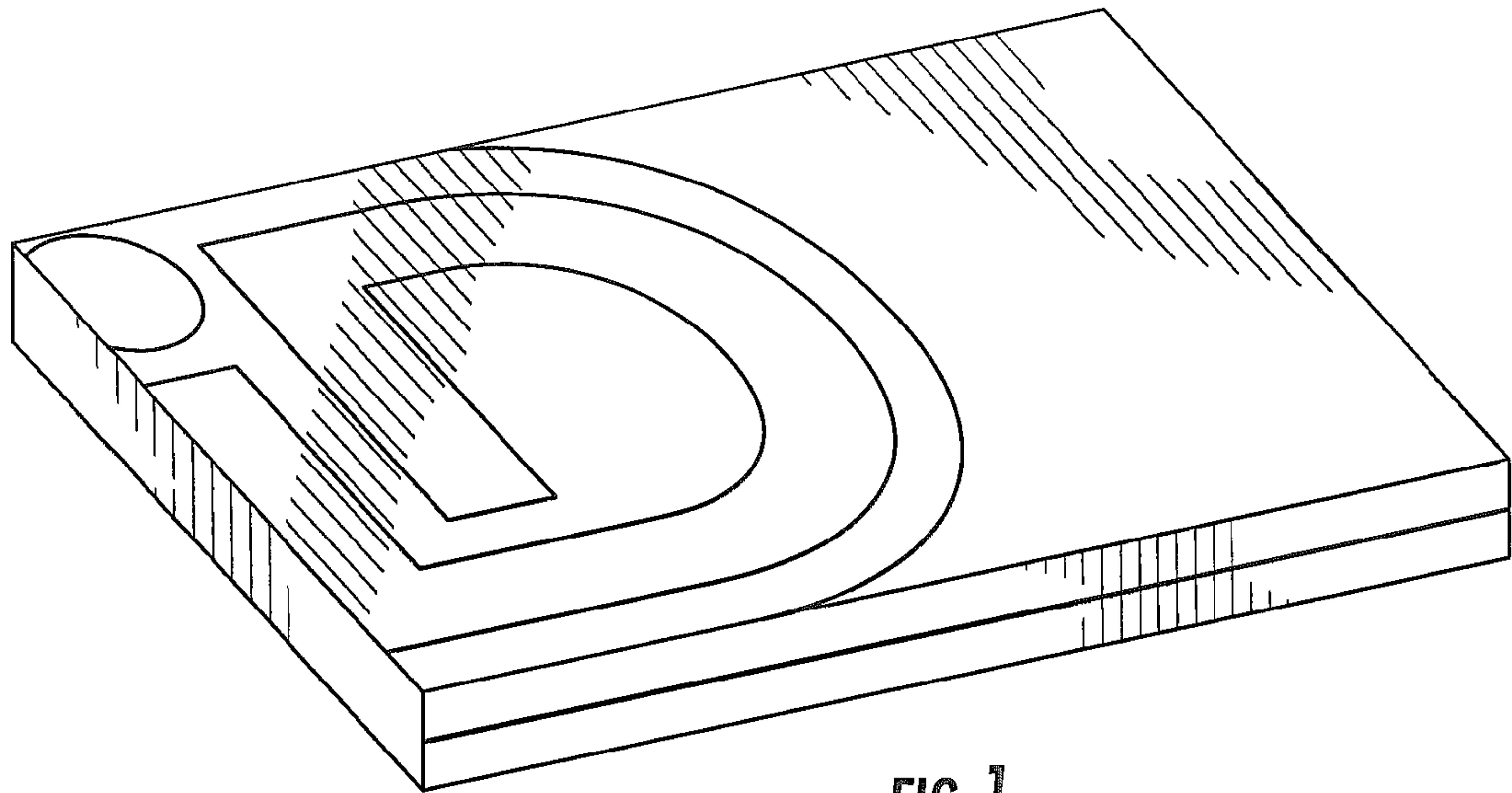

FIG. 1

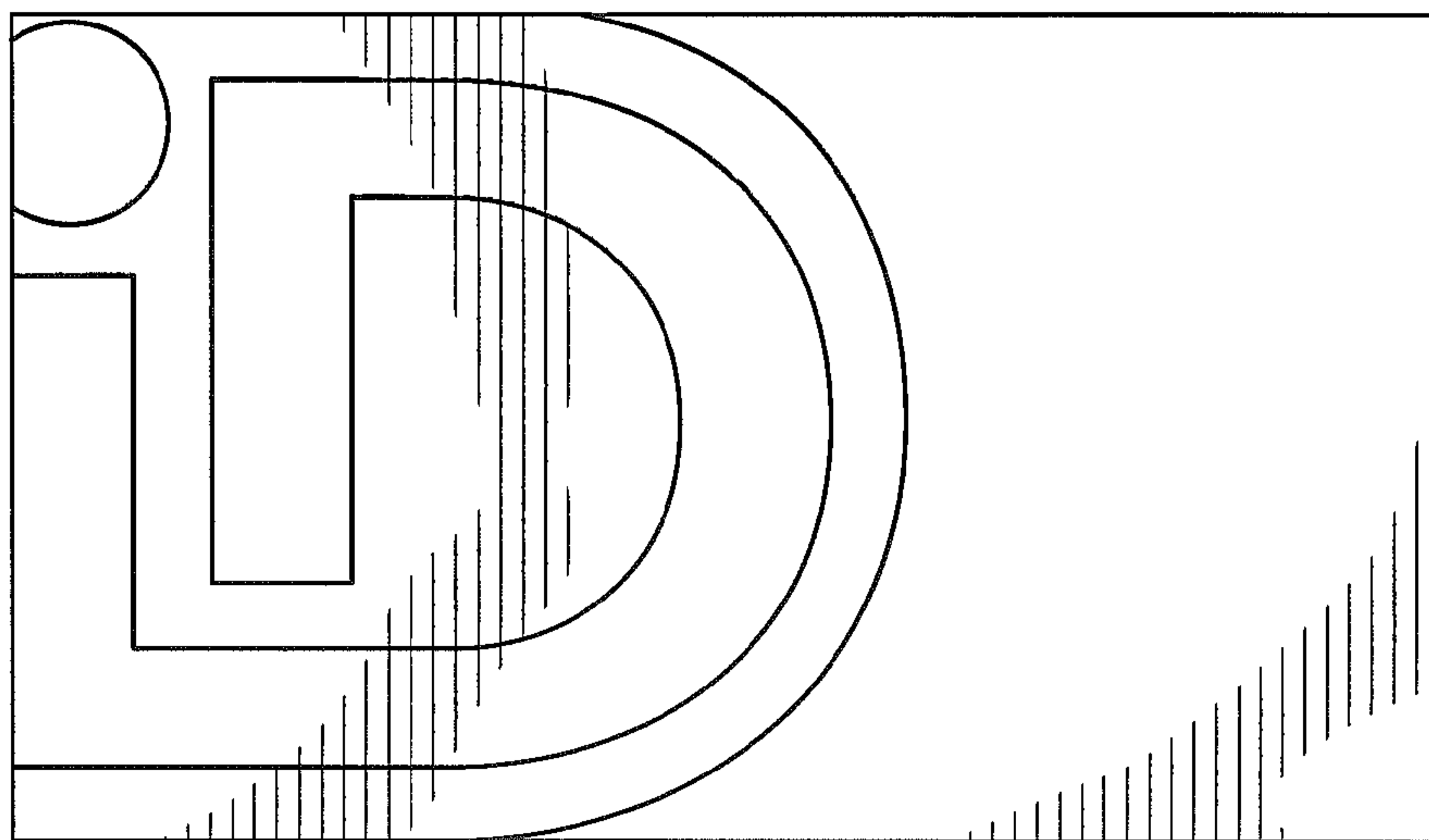

FIG. 2

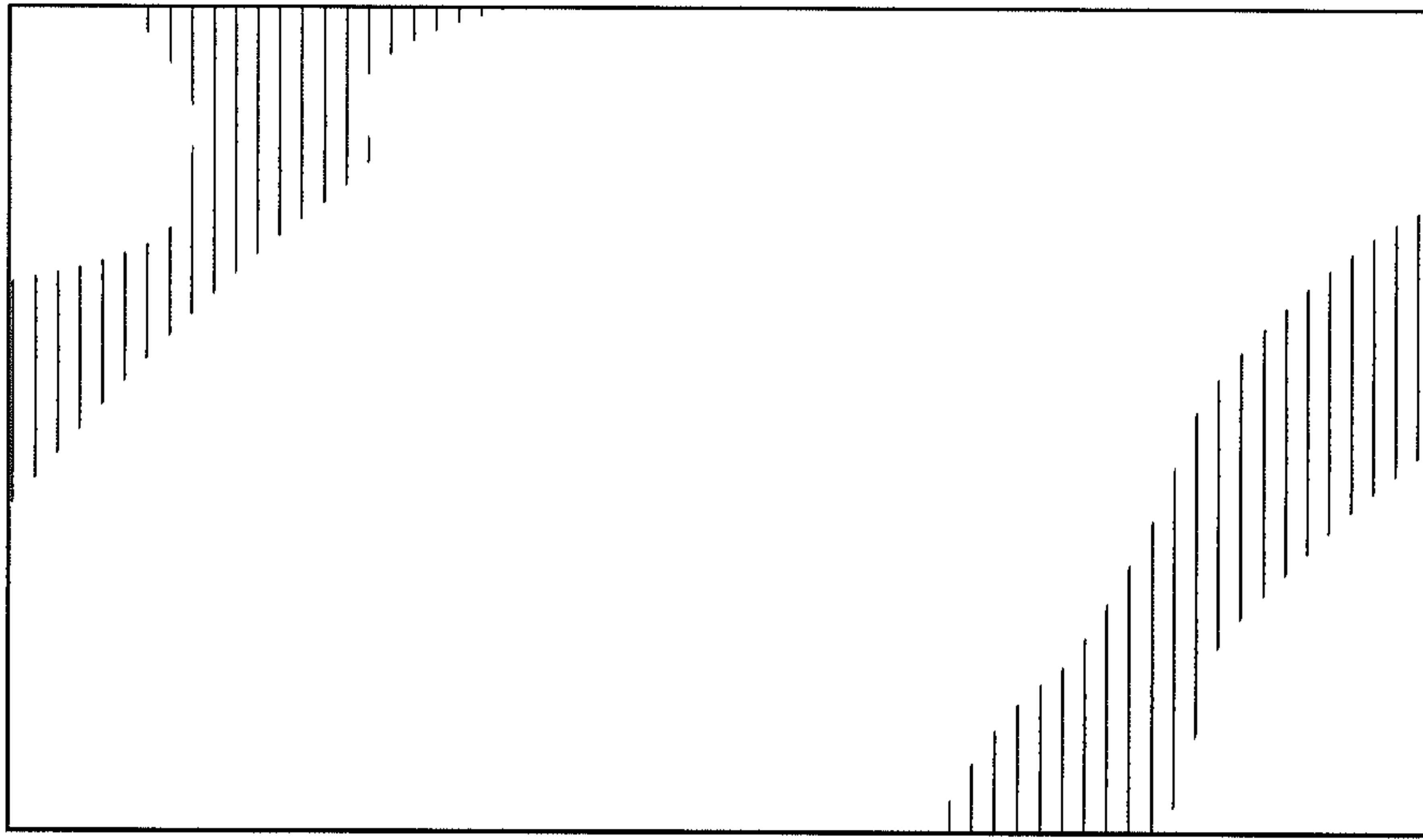

FIG. 3

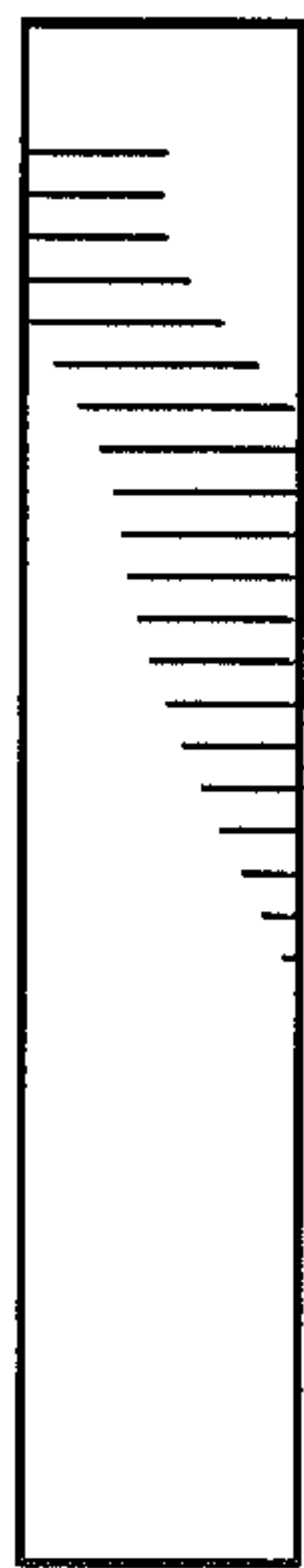

FIG. 4

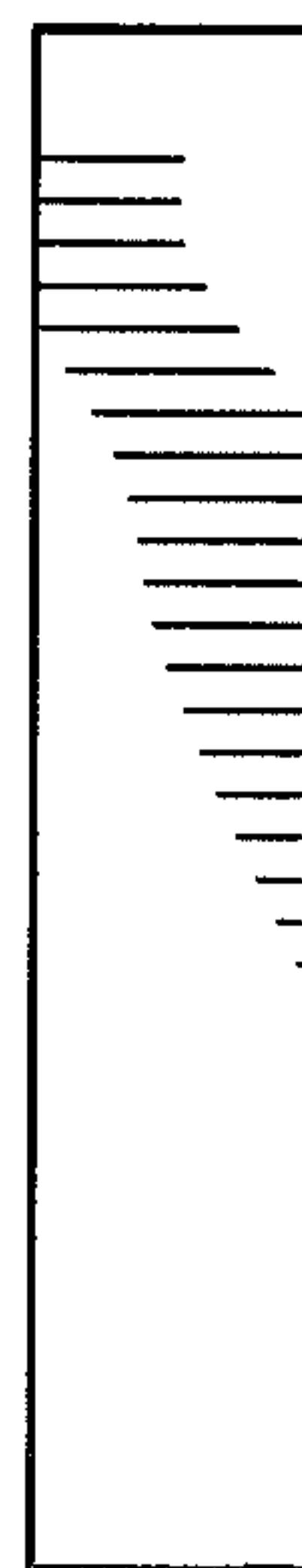

FIG. 5



FIG. 6

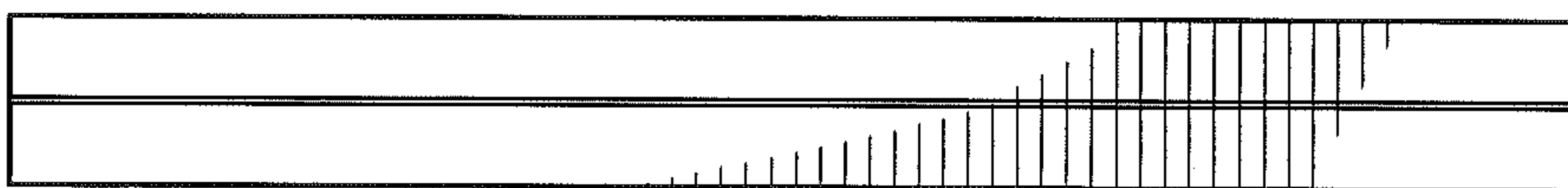

FIG. 7

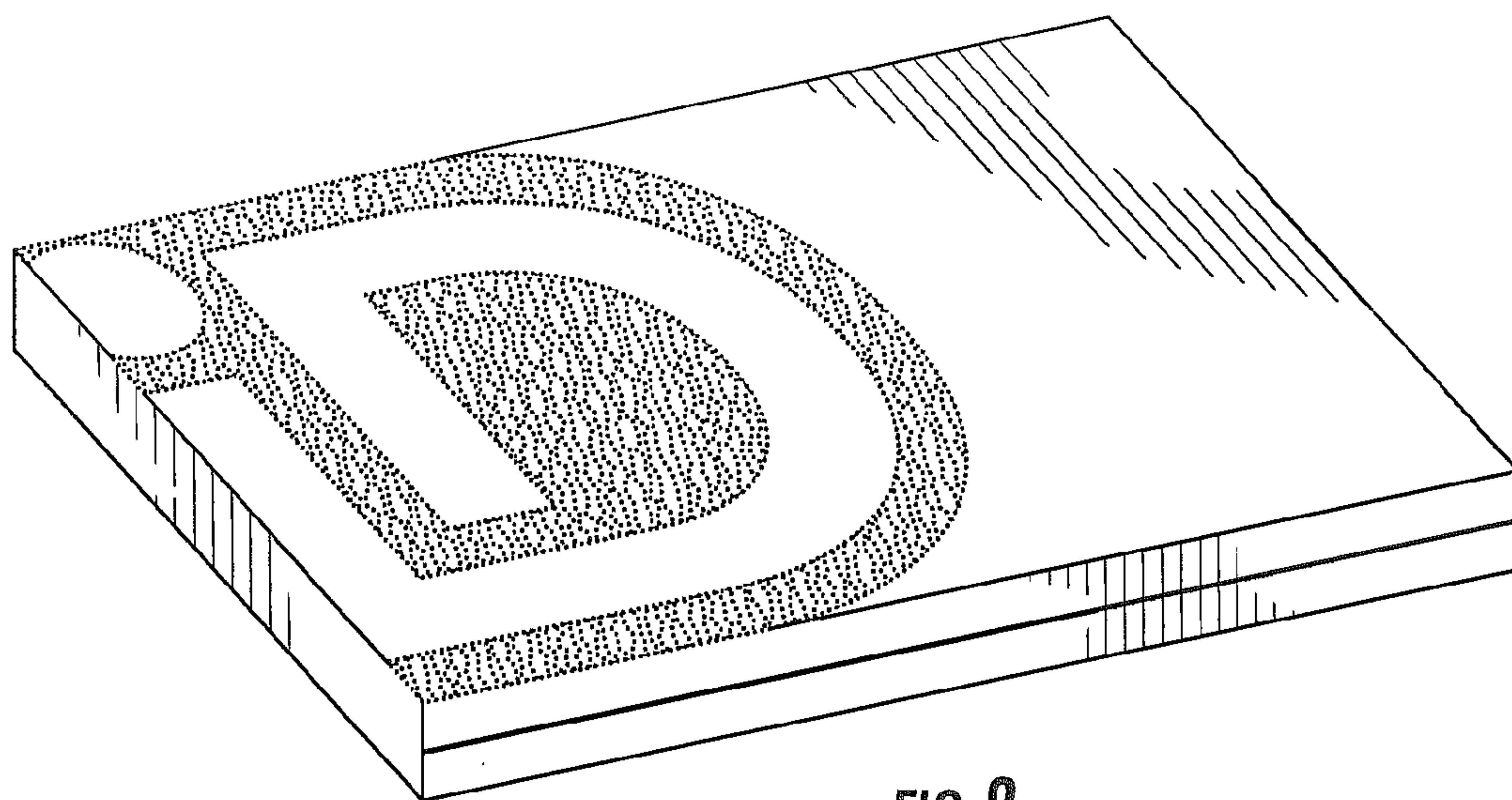

FIG. 8

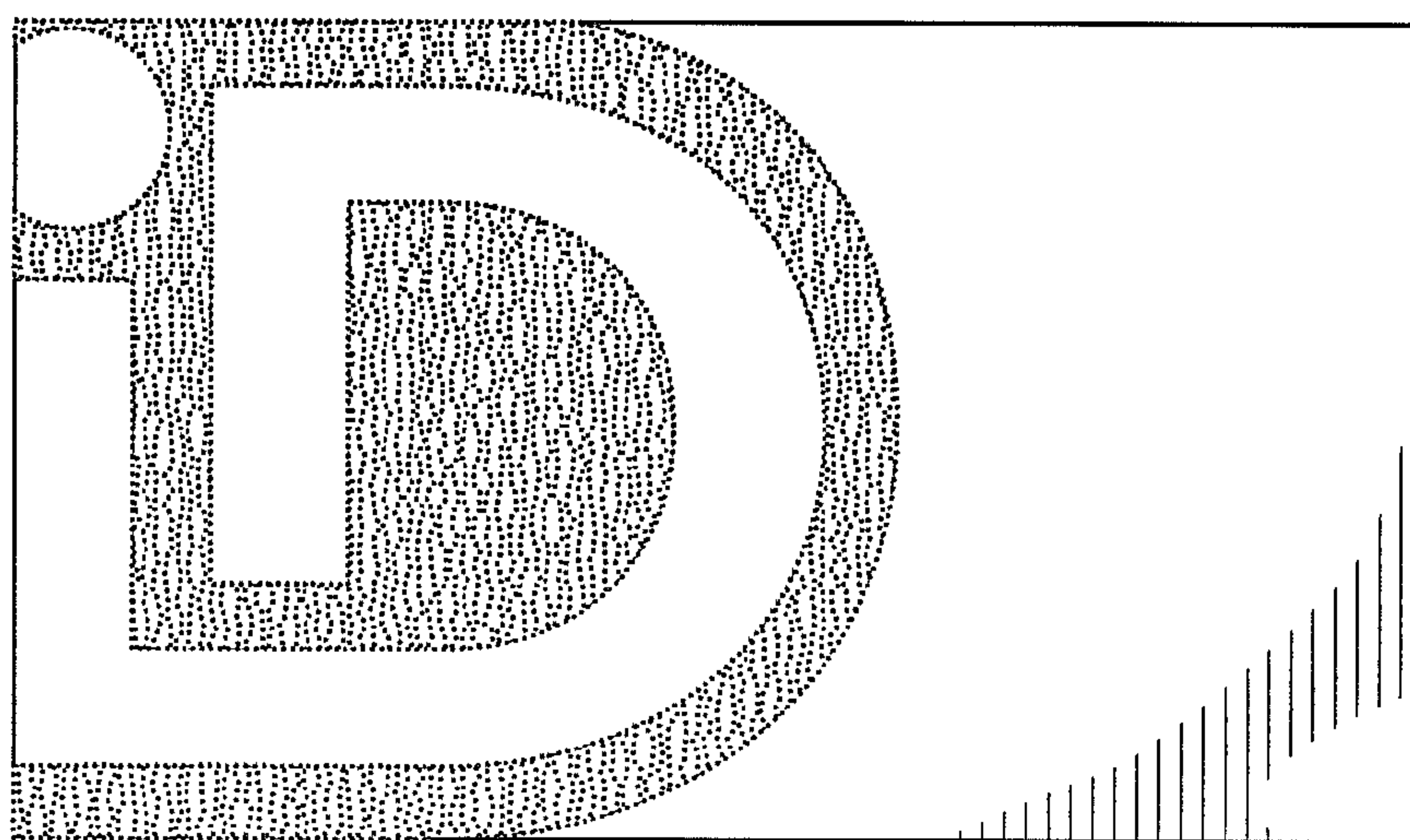

FIG. 9

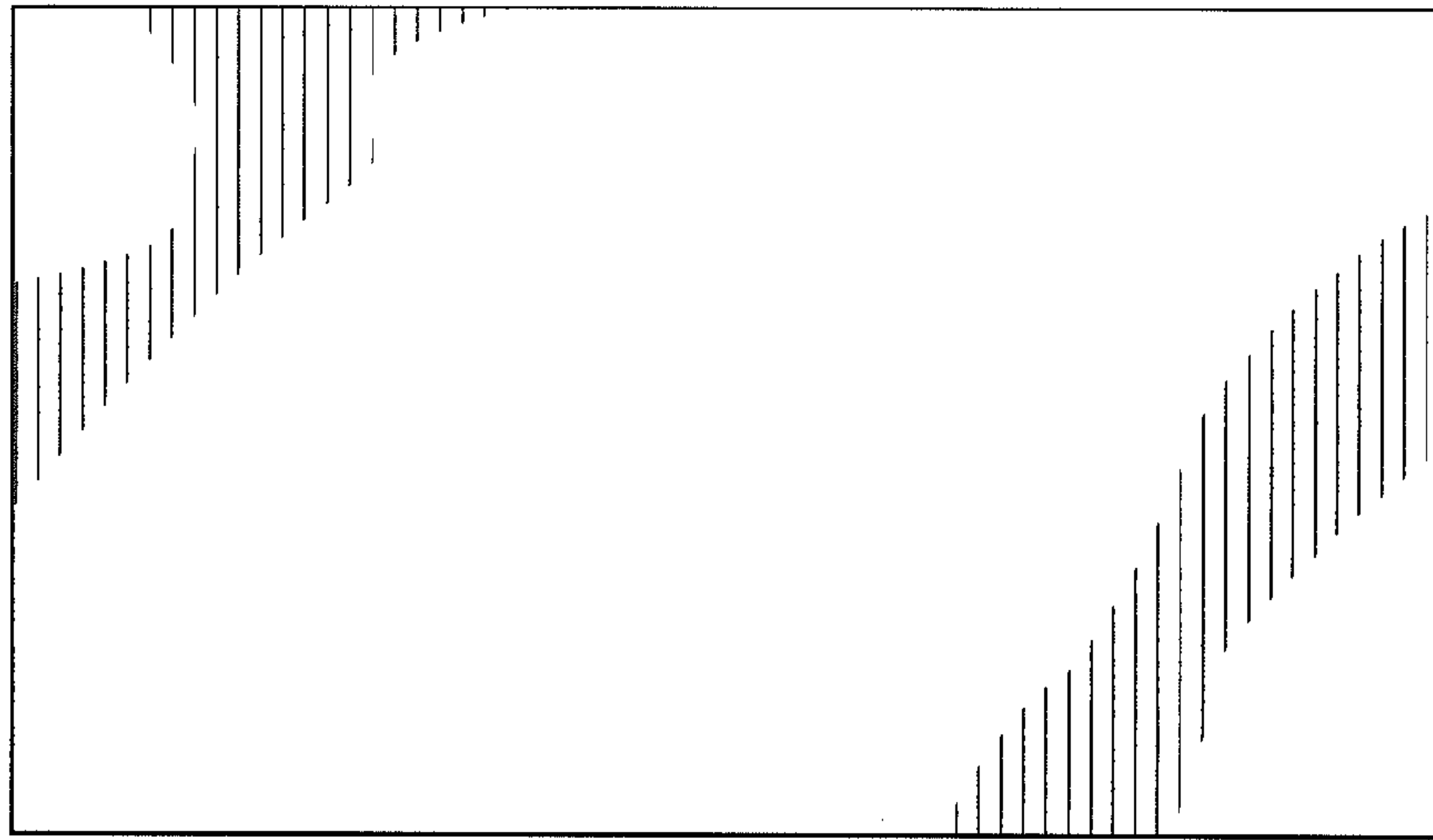

FIG. 10

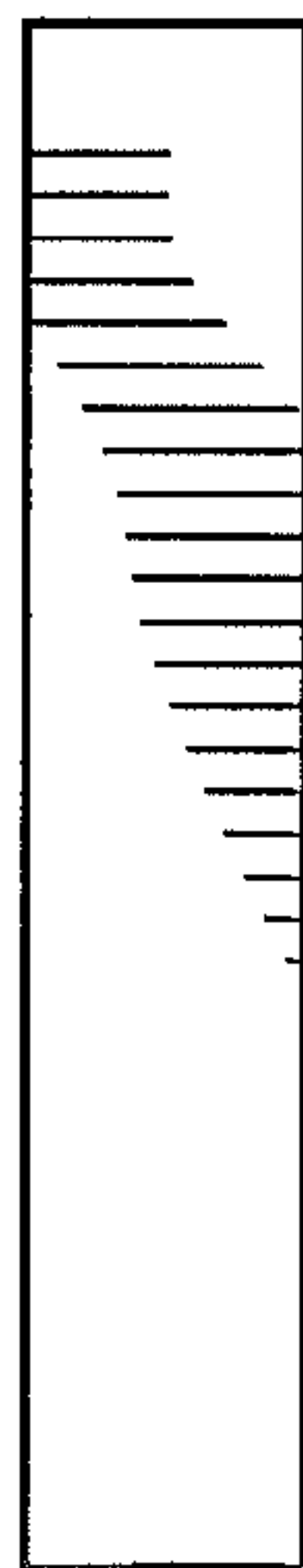

FIG. 11

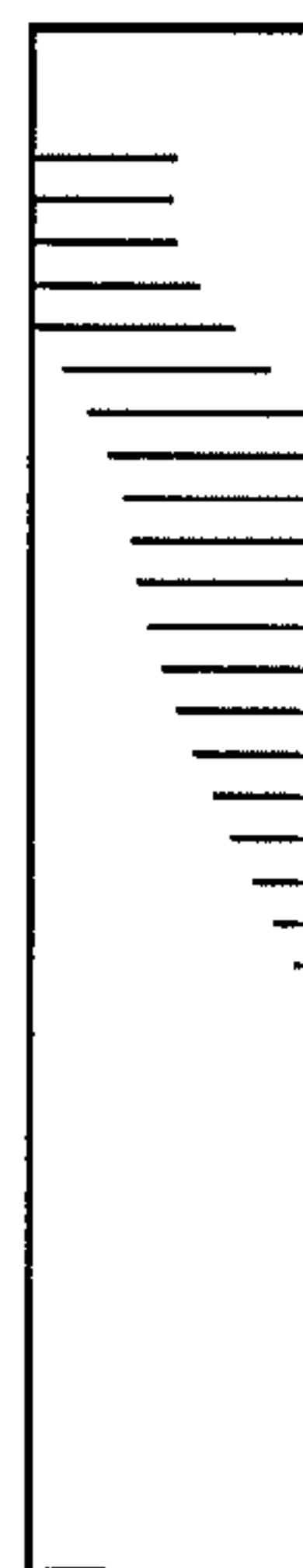

FIG. 12



FIG. 13

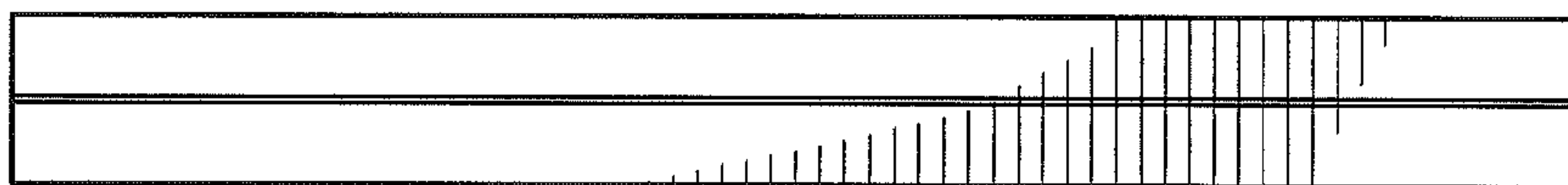

FIG. 14