

US00D699528S

(12) **United States Design Patent**
Randolph et al.

(10) **Patent No.:** **US D699,528 S**

(45) **Date of Patent:** **** Feb. 18, 2014**

(54) **SPADE BLADE**

(56) **References Cited**

(71) Applicant: **Ames True Temper, Inc.**, Camp Hill, PA
(US)

U.S. PATENT DOCUMENTS

(72) Inventors: **David Randolph**, State College, PA
(US); **James M. Wagner**, Lewistown,
PA (US); **Cloyd R. Shawver**,
Lewistown, PA (US); **Jeff Koenig**,
Mechanicsburg, PA (US)

D388,668 S *	1/1998	Rich et al.	D8/10
D527,960 S *	9/2006	Fortier	D8/10
D533,754 S *	12/2006	Fortier	D8/10
D570,654 S *	6/2008	Baker	D8/10
D579,288 S *	10/2008	Baker	D8/10
D601,866 S *	10/2009	Carroll	D8/10
D617,616 S *	6/2010	Randolph et al.	D8/10
D626,390 S *	11/2010	Randolph et al.	D8/10
D628,452 S *	12/2010	Randolph et al.	D8/10
D650,250 S *	12/2011	Frenkel	D8/10
D665,637 S *	8/2012	Baker	D8/10

(73) Assignee: **Ames True Temper, Inc.**, Camp Hill, PA
(US)

* cited by examiner

(**) Term: **14 Years**

Primary Examiner — Sheryl Lane

(74) *Attorney, Agent, or Firm* — Eckert Seamans Cherin &
Mellott, LLC; David C. Jenkins

(21) Appl. No.: **29/455,135**

(57) **CLAIM**

The ornamental design for a spade blade, as shown and
described.

(22) Filed: **May 17, 2013**

DESCRIPTION

(51) **LOC (10) Cl.** **08-01**

(52) **U.S. Cl.**
USPC **D8/10**

(58) **Field of Classification Search**

USPC D8/7, 10; 294/49, 53.5, 54.5, 57, 55.5,
294/51, 56, 58; 56/400.01, 400.14;
172/371-372

FIG. 1 is an isometric view of the spade blade;
FIG. 2 is a top view of the spade blade;
FIG. 3 is a bottom view of the spade blade;
FIG. 4 is a right view of the spade blade;
FIG. 5 is a left view of the spade blade;
FIG. 6 is a front view of the spade blade; and,
FIG. 7 is a back view of the spade blade.
The broken lines in the drawings depict environmental sub-
ject matter only and form no part of the claimed design.

See application file for complete search history.

1 Claim, 6 Drawing Sheets

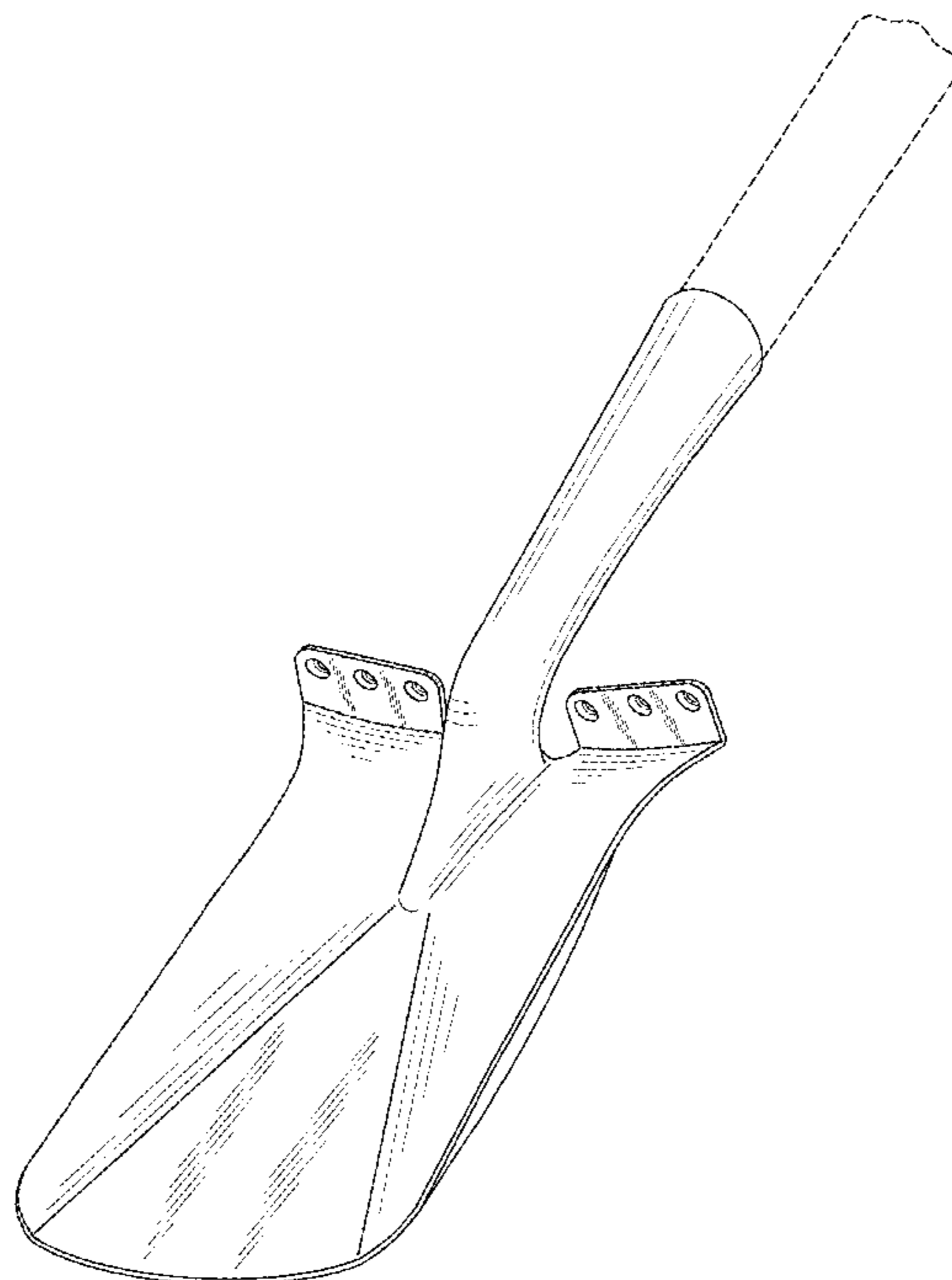

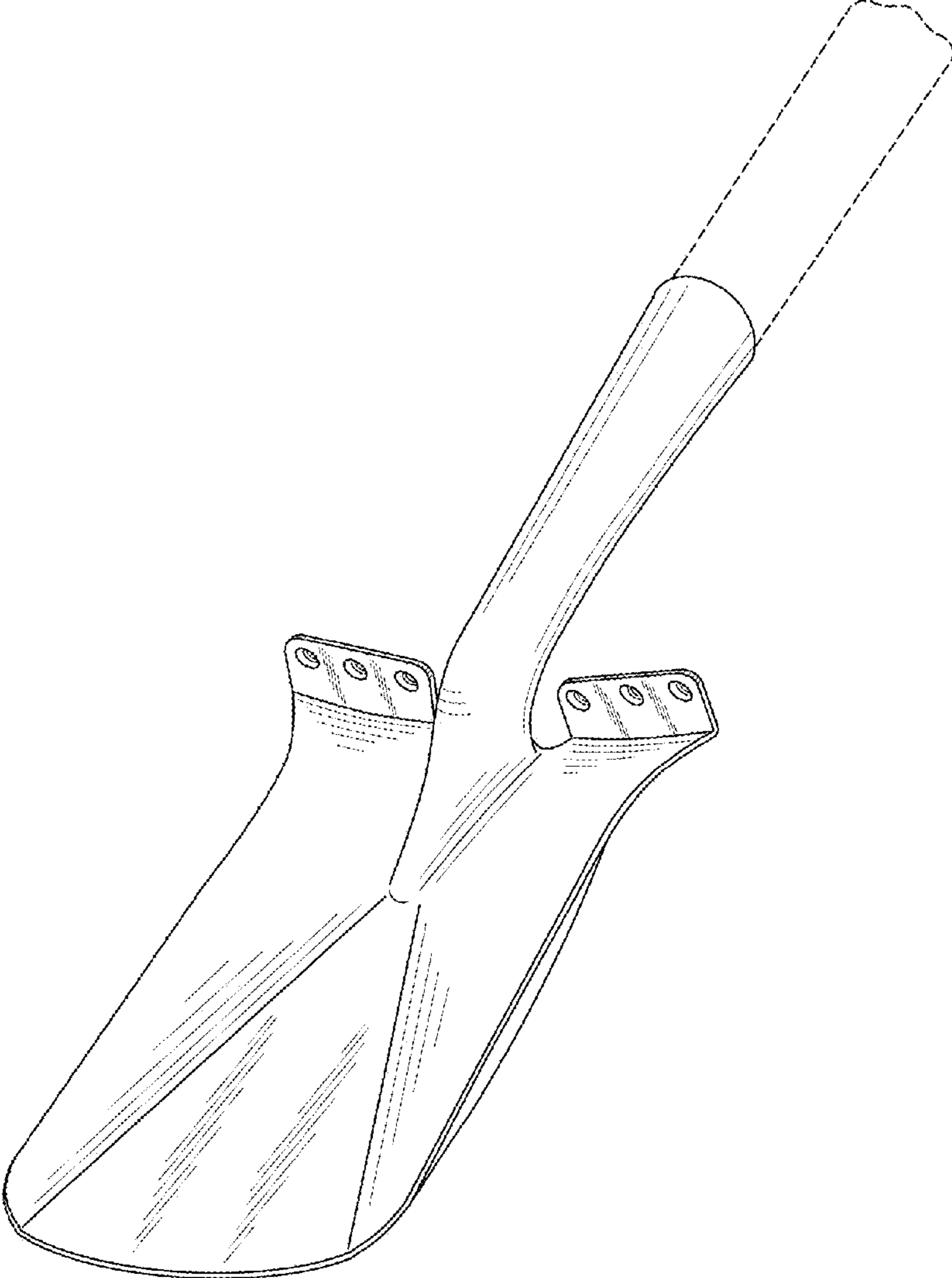

FIG. 1

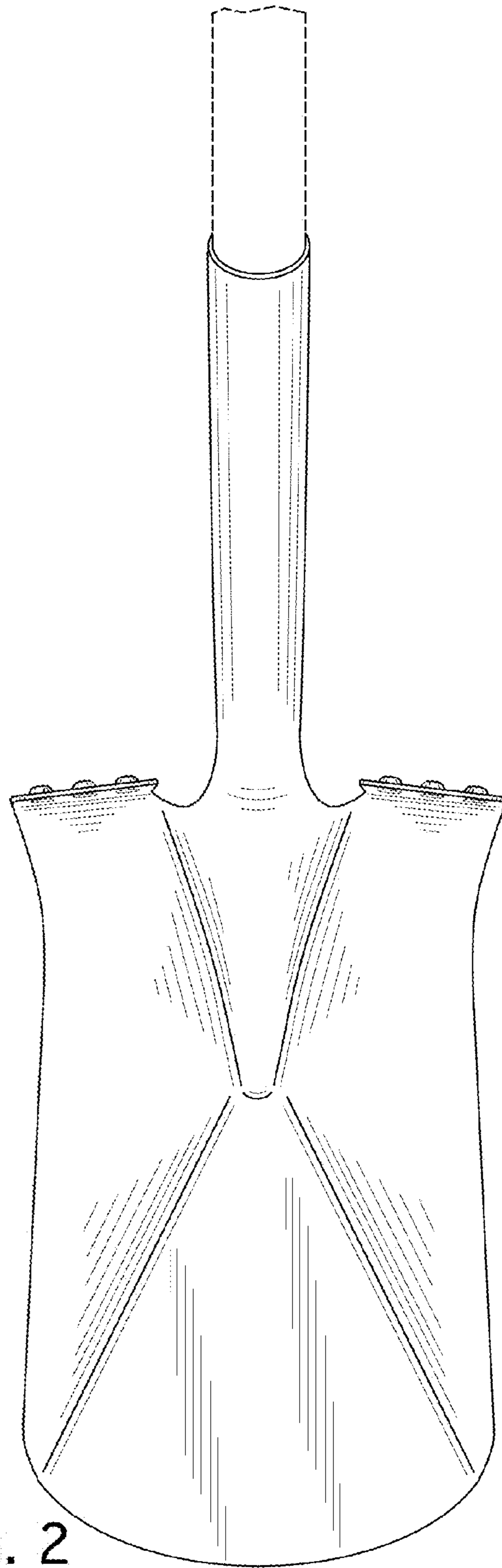

FIG. 2

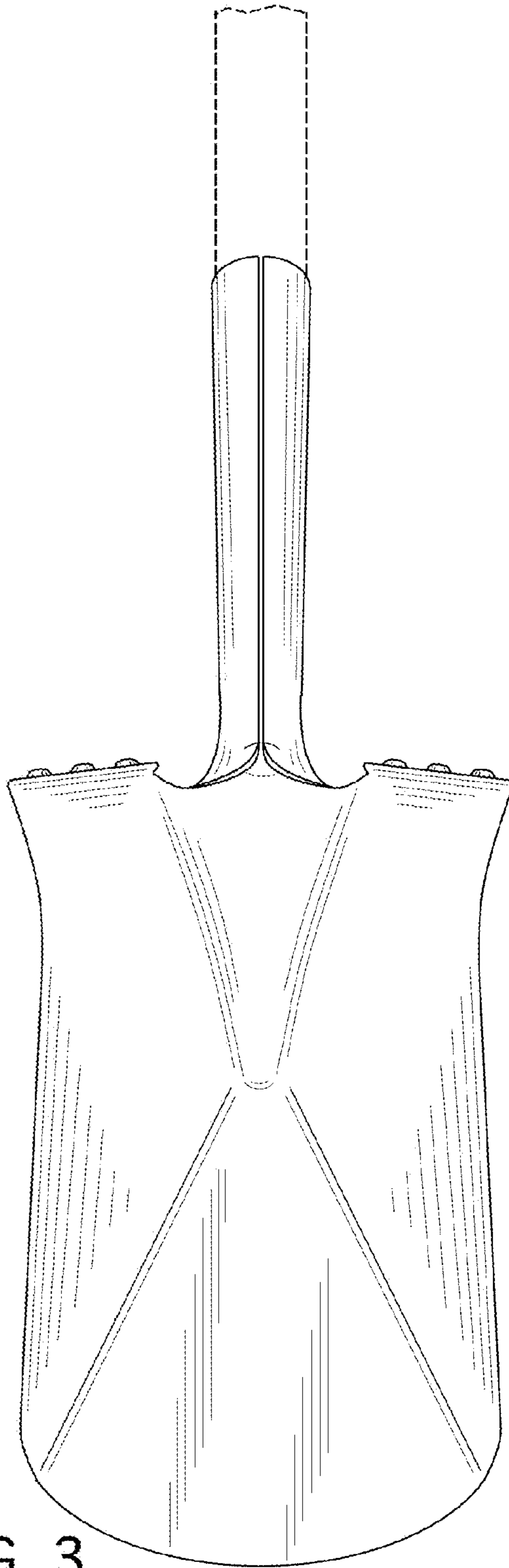

FIG. 3

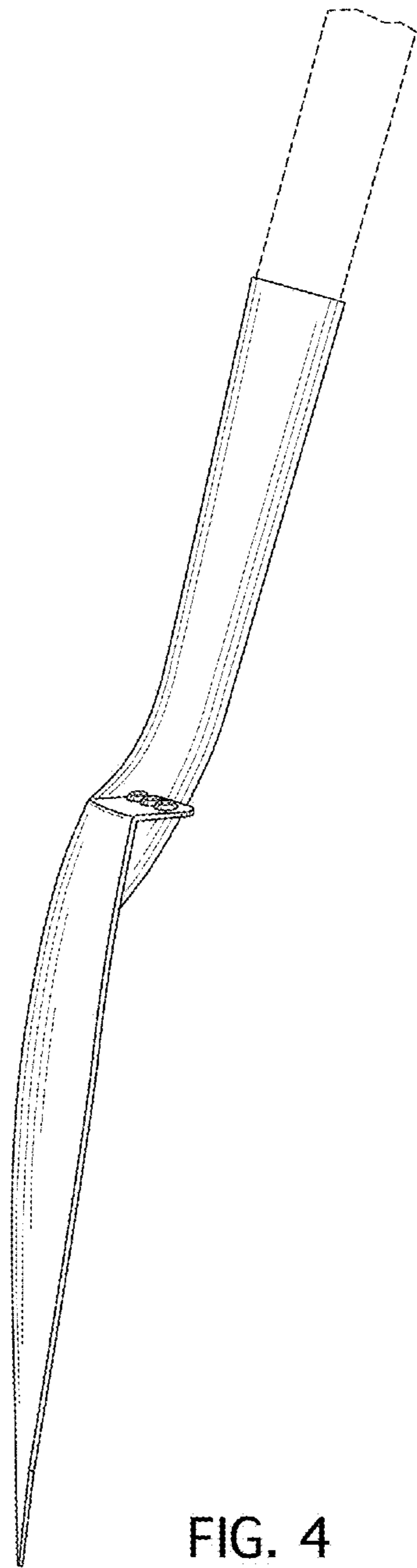

FIG. 4

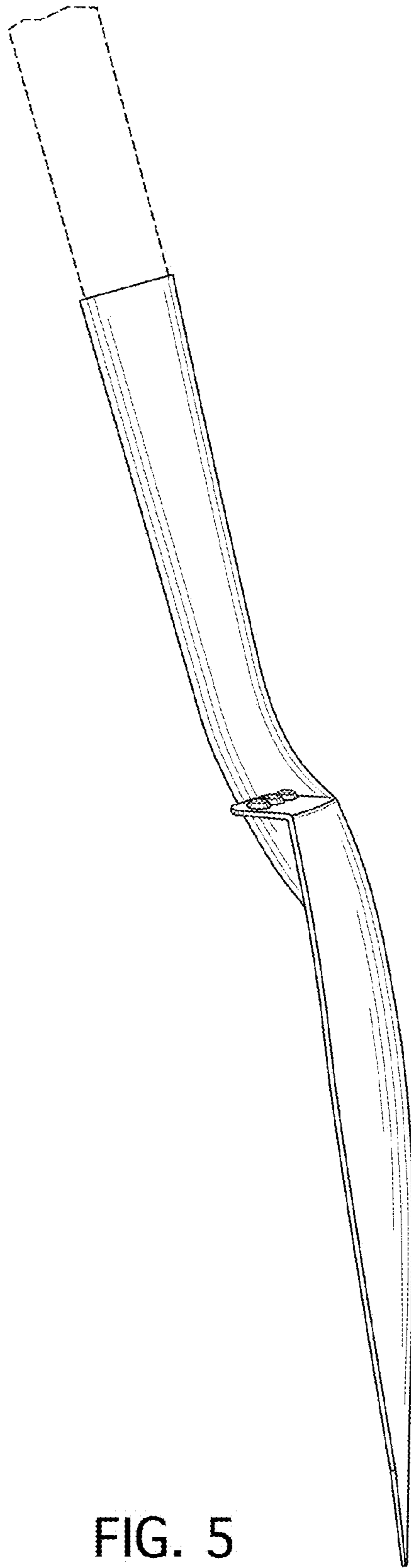

FIG. 5

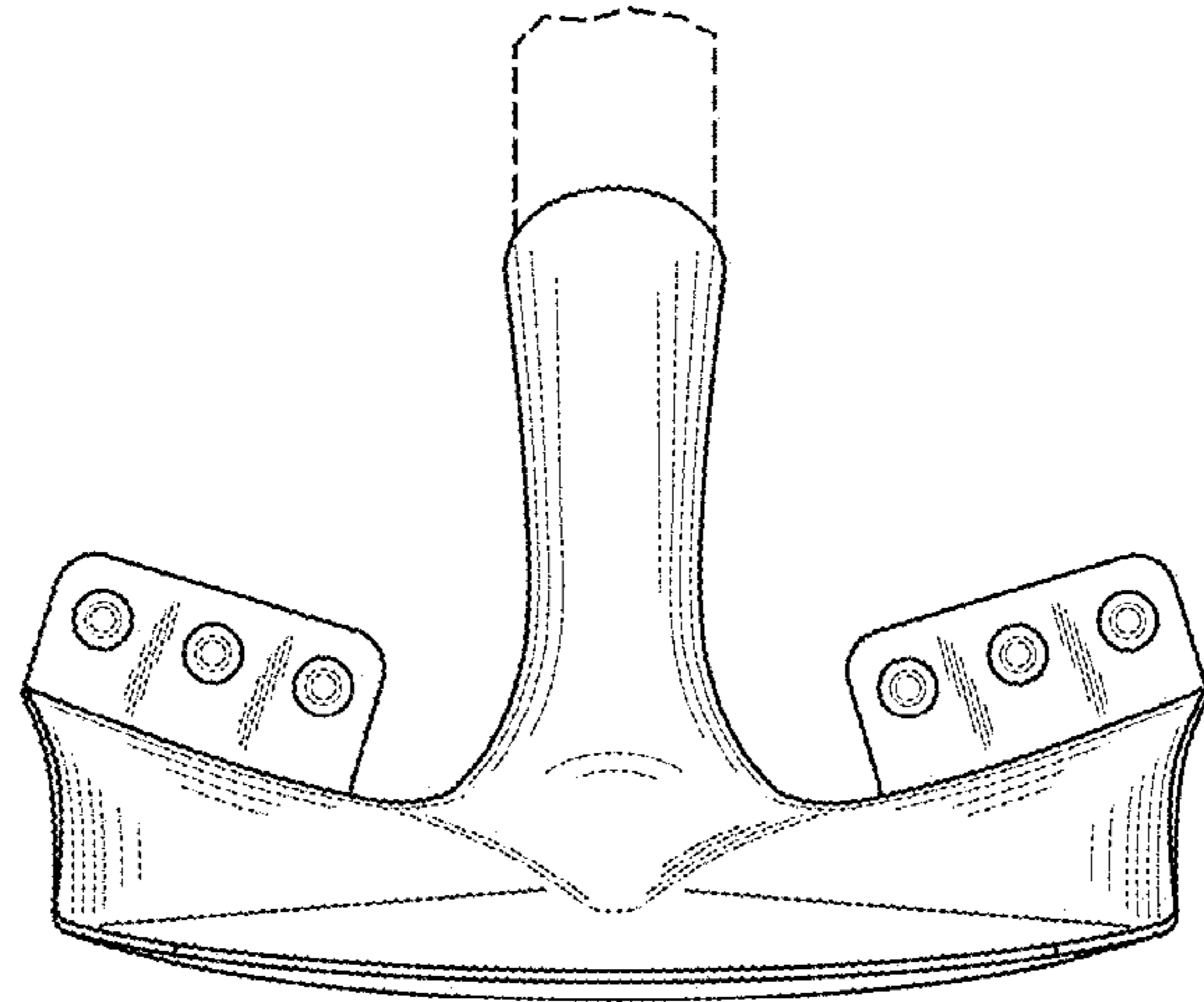

FIG. 6

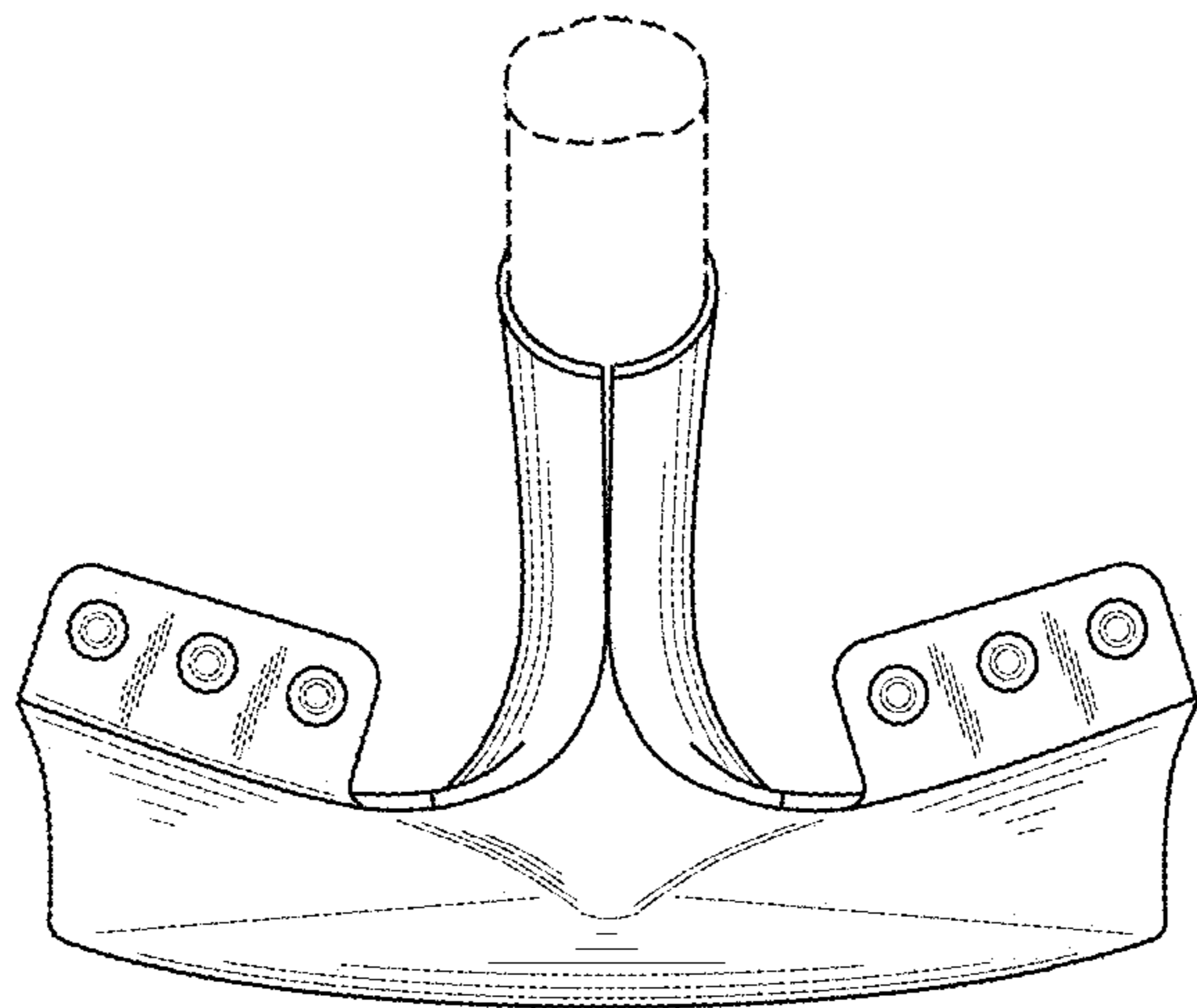

FIG. 7

UNITED STATES PATENT AND TRADEMARK OFFICE
CERTIFICATE OF CORRECTION

PATENT NO. : D699,528 S
APPLICATION NO. : 29/455135
DATED : February 18, 2014
INVENTOR(S) : David Randolph et al.

Page 1 of 7

It is certified that error appears in the above-identified patent and that said Letters Patent is hereby corrected as shown below:

Drawings

The original figures as submitted showed contour lines, not broken lines.

A clear set of the original six drawing sheets (Figures 1-7) is attached.

Signed and Sealed this
Twenty-ninth Day of March, 2016



Michelle K. Lee
Director of the United States Patent and Trademark Office

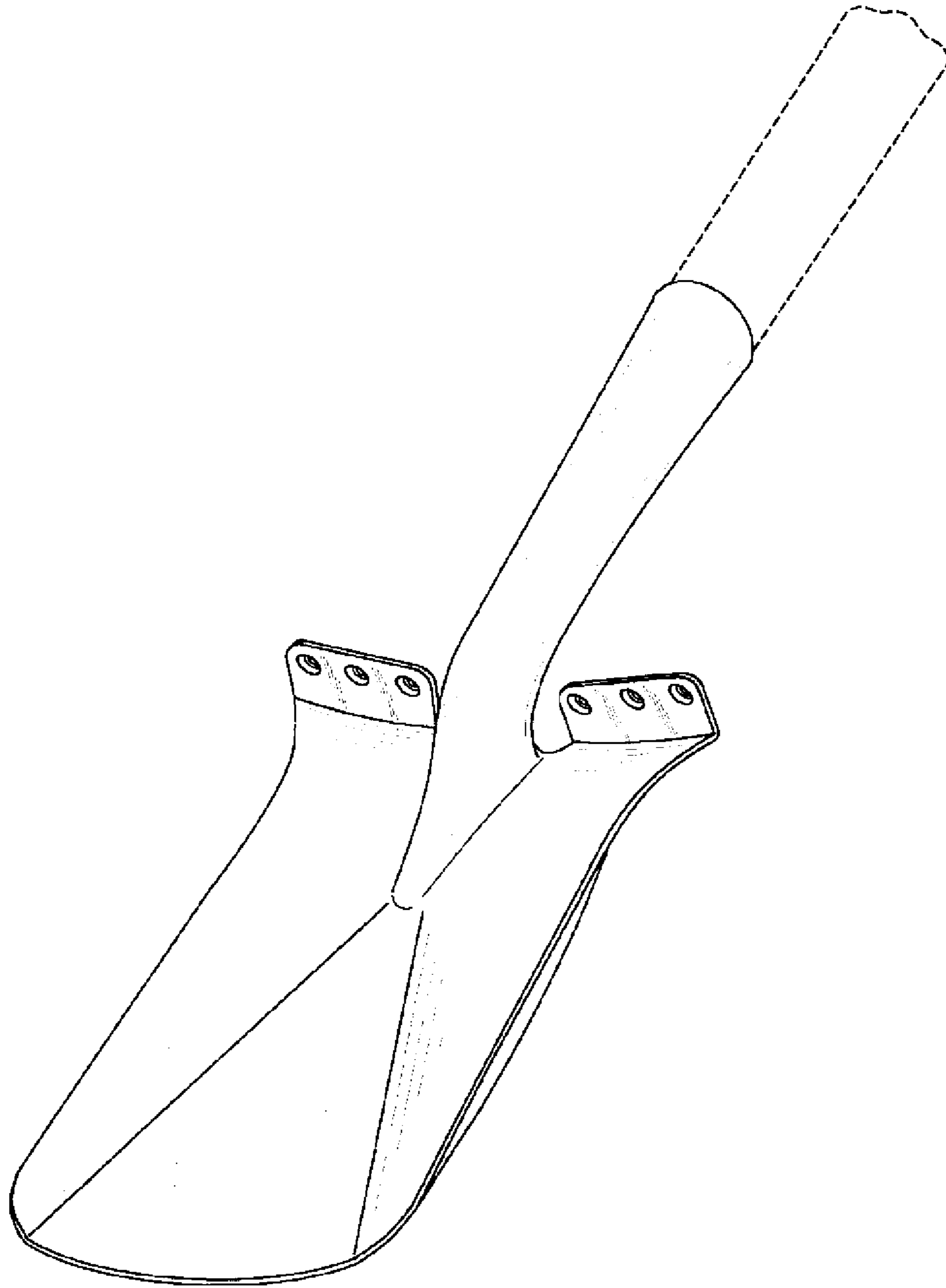

FIG. 1

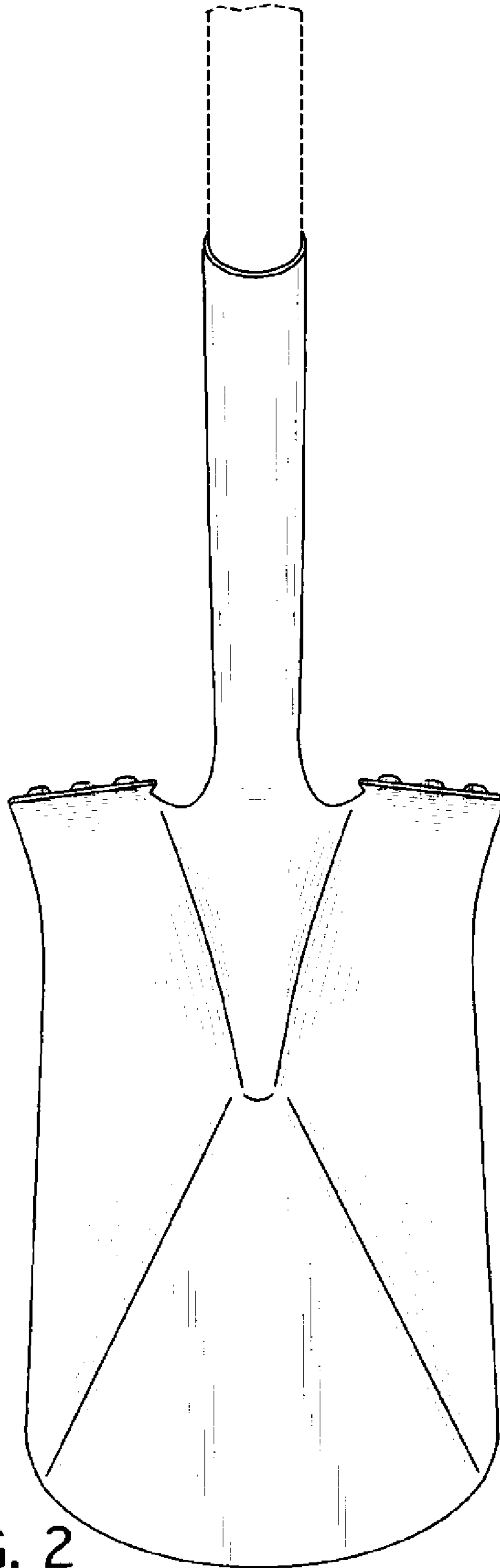

FIG. 2

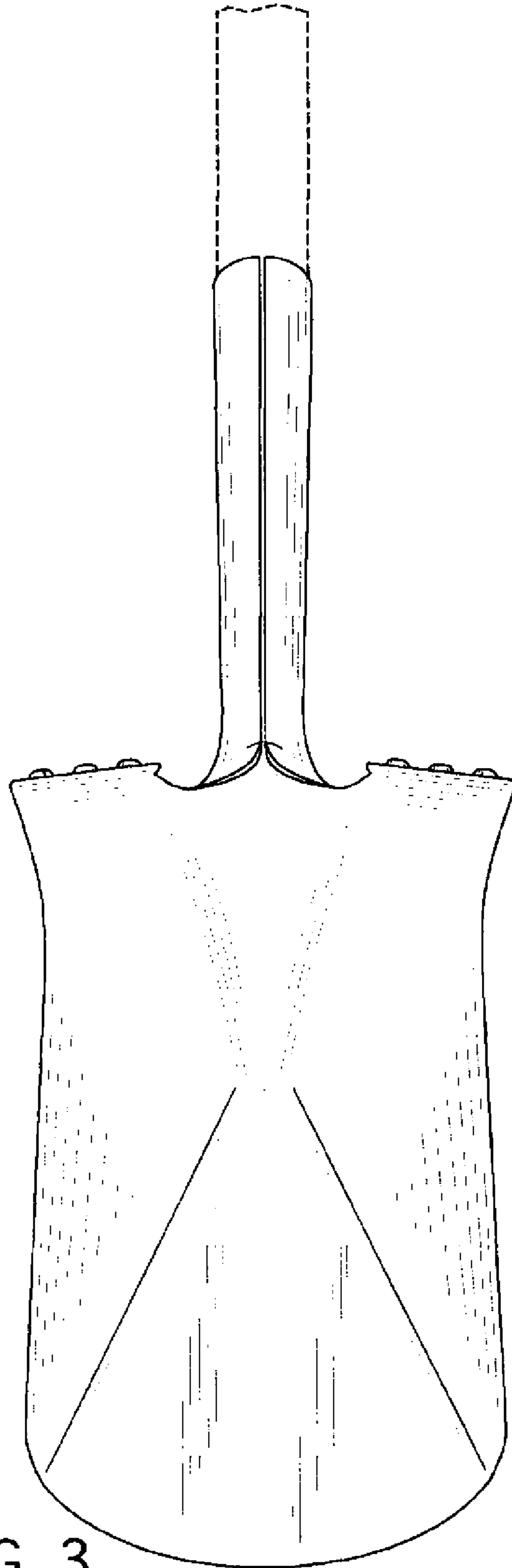

FIG. 3

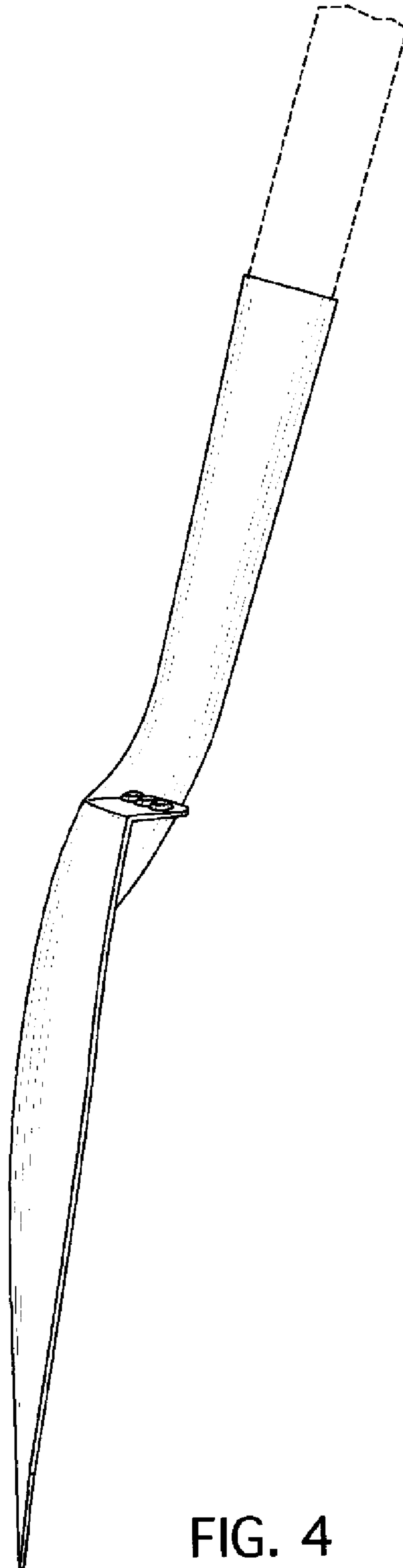

FIG. 4

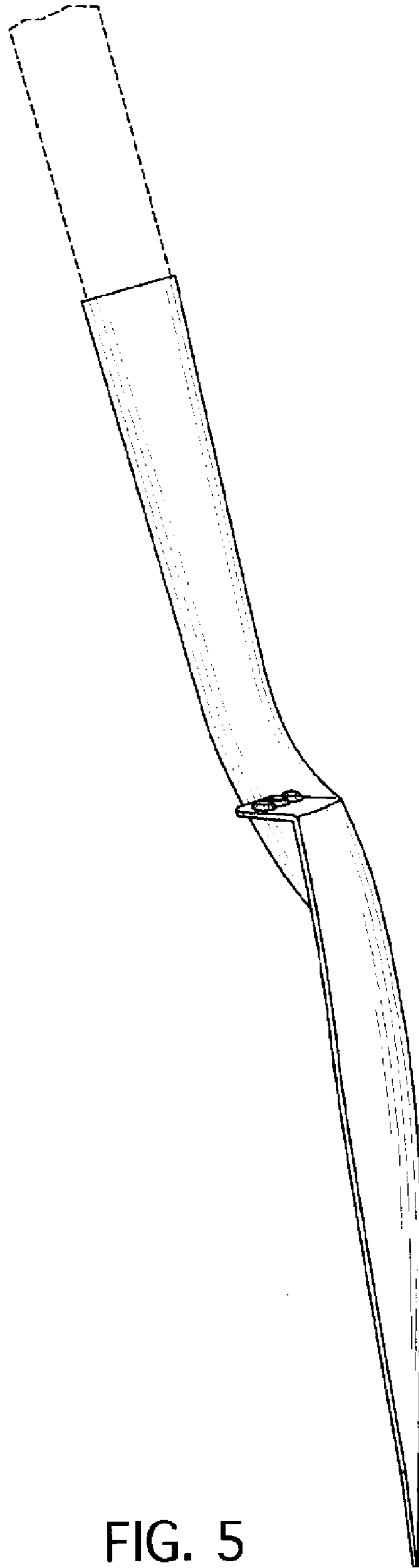

FIG. 5

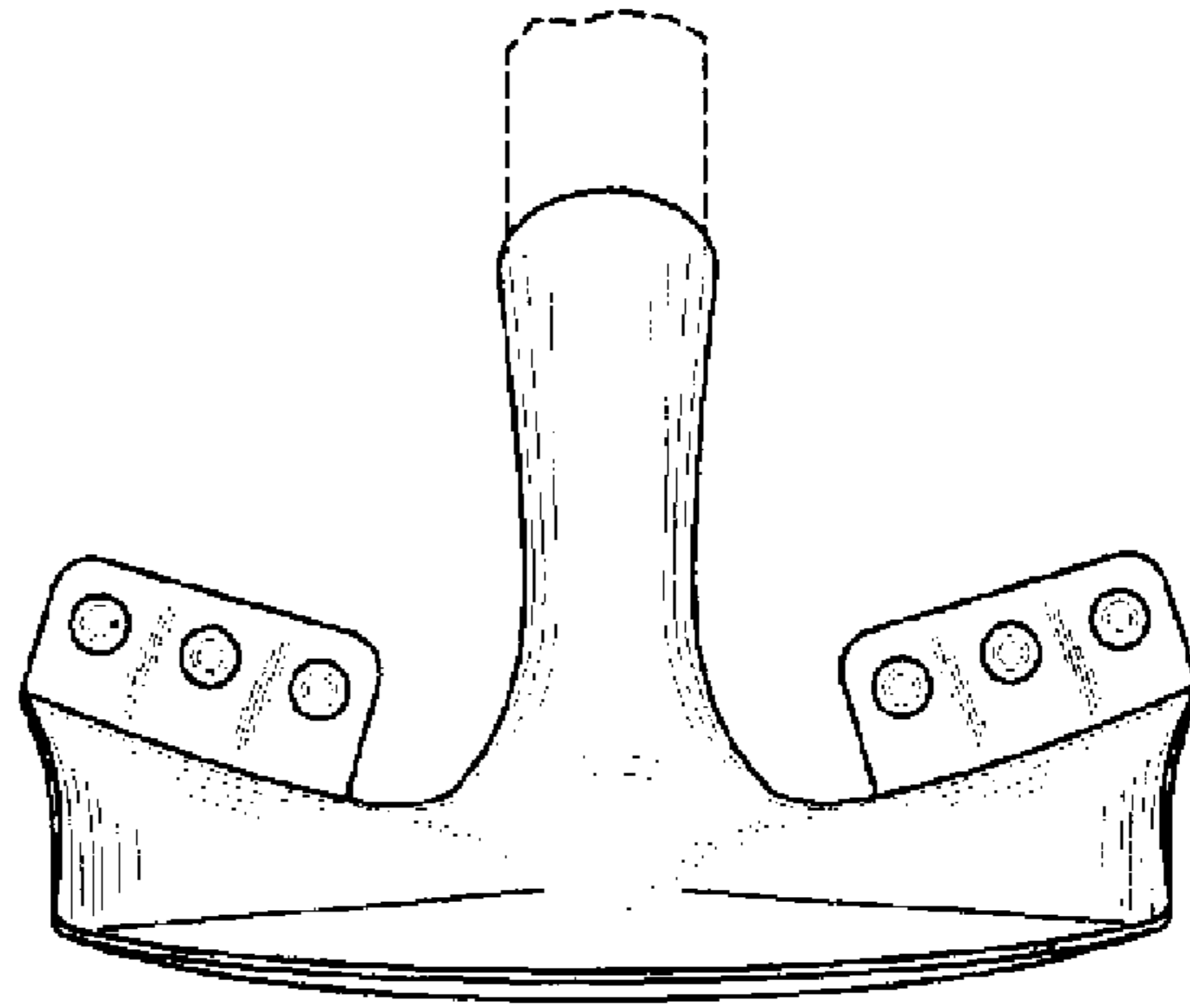

FIG. 6

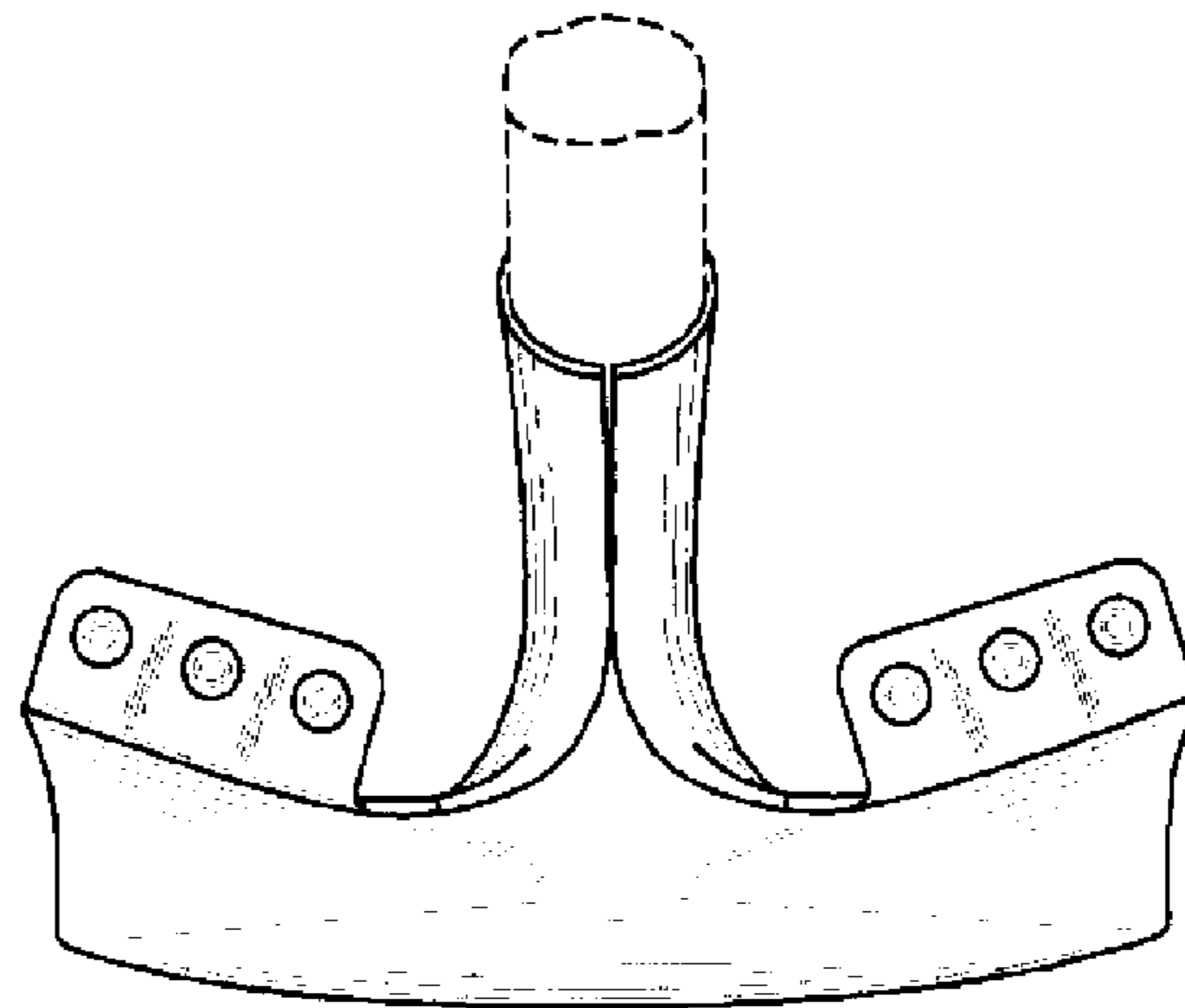

FIG. 7

UNITED STATES PATENT AND TRADEMARK OFFICE
CERTIFICATE OF CORRECTION

PATENT NO. : D699,528 S
APPLICATION NO. : 29/455135
DATED : February 18, 2014
INVENTOR(S) : David Randolph et al.

Page 1 of 8

It is certified that error appears in the above-identified patent and that said Letters Patent is hereby corrected as shown below:

Substitute the Title Page with the attached Title Page.

Drawings

The original figures as submitted showed contour lines, not broken lines.

A clear set of the original six drawing sheets (Figures 1-7) is attached.

This certificate supersedes the Certificate of Correction issued March 29, 2016.

Signed and Sealed this
Twelfth Day of July, 2016



Michelle K. Lee
Director of the United States Patent and Trademark Office

(12) **United States Design Patent** (10) **Patent No.:** **US D699,528 S**
Randolph et al. (45) **Date of Patent:** **** Feb. 18, 2014**

(54) **SPADE BLADE**

(71) Applicant: **Ames True Temper, Inc.**, Camp Hill, PA (US)

(72) Inventors: **David Randolph**, State College, PA (US); **James M. Wagner**, Lewistown, PA (US); **Cloyd R. Shawver**, Lewistown, PA (US); **Jeff Koenig**, Mechanicsburg, PA (US)

(73) Assignee: **Ames True Temper, Inc.**, Camp Hill, PA (US)

(**) Term: **14 Years**

(21) Appl. No.: **29/455,135**

(22) Filed: **May 17, 2013**

(51) **LOC (10) Cl.** **08-01**

(52) **U.S. Cl.**
 USPC **D8/10**

(58) **Field of Classification Search**
 USPC D8/7, 10; 294/49, 53.5, 54.5, 57, 55.5, 294/51, 56, 58; 56/400.01, 400.14; 172/371, 372

See application file for complete search history.

(56) **References Cited**

U.S. PATENT DOCUMENTS

D388,668 S *	1/1998	Rich et al.	D8/10
D527,960 S *	9/2006	Fortier	D8/10
D533,754 S *	12/2006	Fortier	D8/10
D570,654 S *	6/2008	Baker	D8/10
D579,288 S *	10/2008	Baker	D8/10
D601,866 S *	10/2009	Carroll	D8/10
D617,616 S *	6/2010	Randolph et al.	D8/10
D626,390 S *	11/2010	Randolph et al.	D8/10
D628,452 S *	12/2010	Randolph et al.	D8/10
D650,250 S *	12/2011	Frenkel	D8/10
D665,637 S *	8/2012	Baker	D8/10

* cited by examiner

Primary Examiner Sheryl Lane

(74) *Attorney, Agent, or Firm* Eckert Seamans Cherin & Mellott, LLC; David C. Jenkins

(57) **CLAIM**

The ornamental design for a spade blade, as shown and described.

DESCRIPTION

FIG. 1 is an isometric view of the spade blade; FIG. 2 is a top view of the spade blade; FIG. 3 is a bottom view of the spade blade; FIG. 4 is a right view of the spade blade; FIG. 5 is a left view of the spade blade; FIG. 6 is a front view of the spade blade; and, FIG. 7 is a back view of the spade blade. The broken lines in the drawings depict environmental subject matter only and form no part of the claimed design.

1 Claim, 6 Drawing Sheets

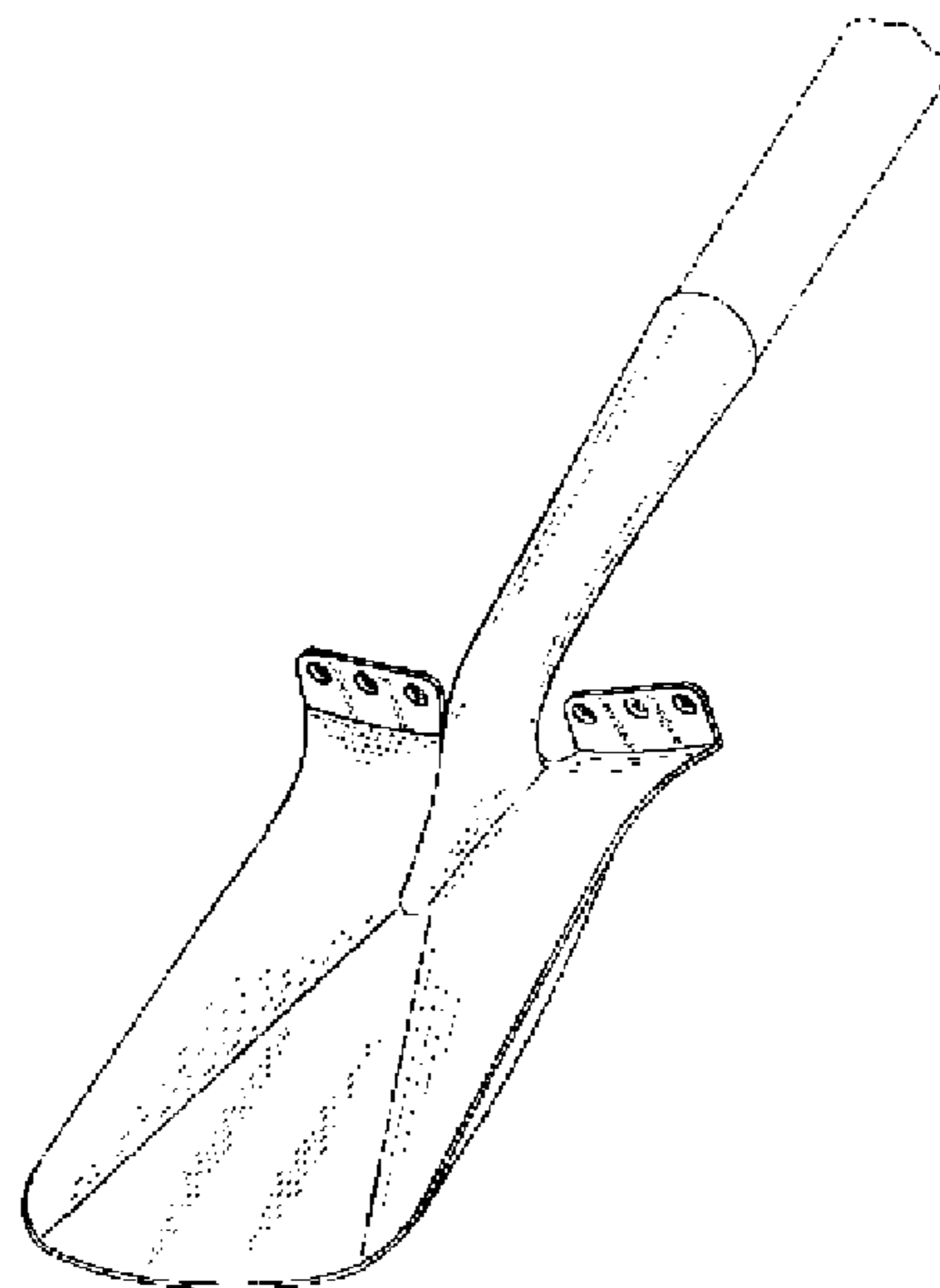

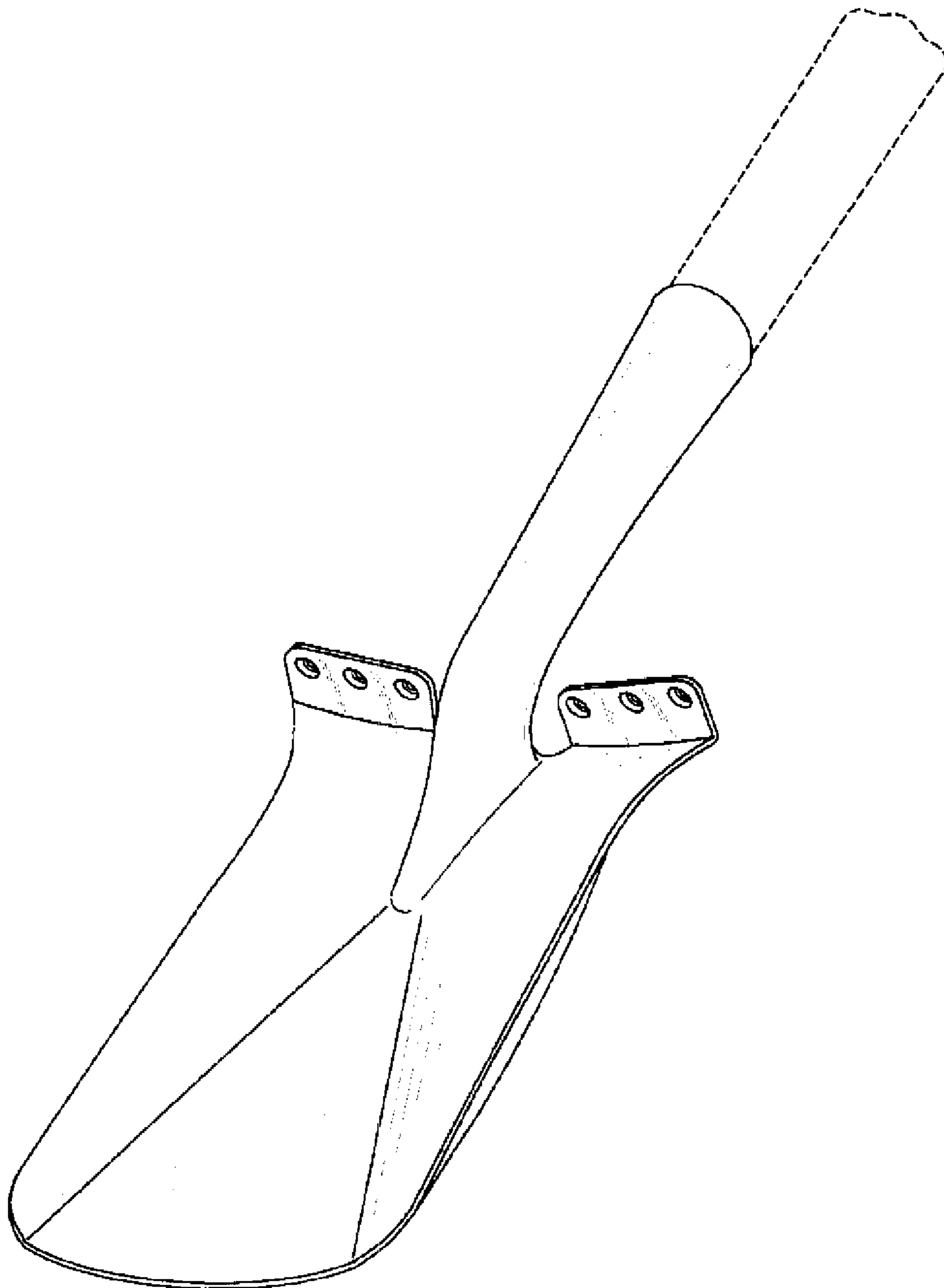

FIG. 1

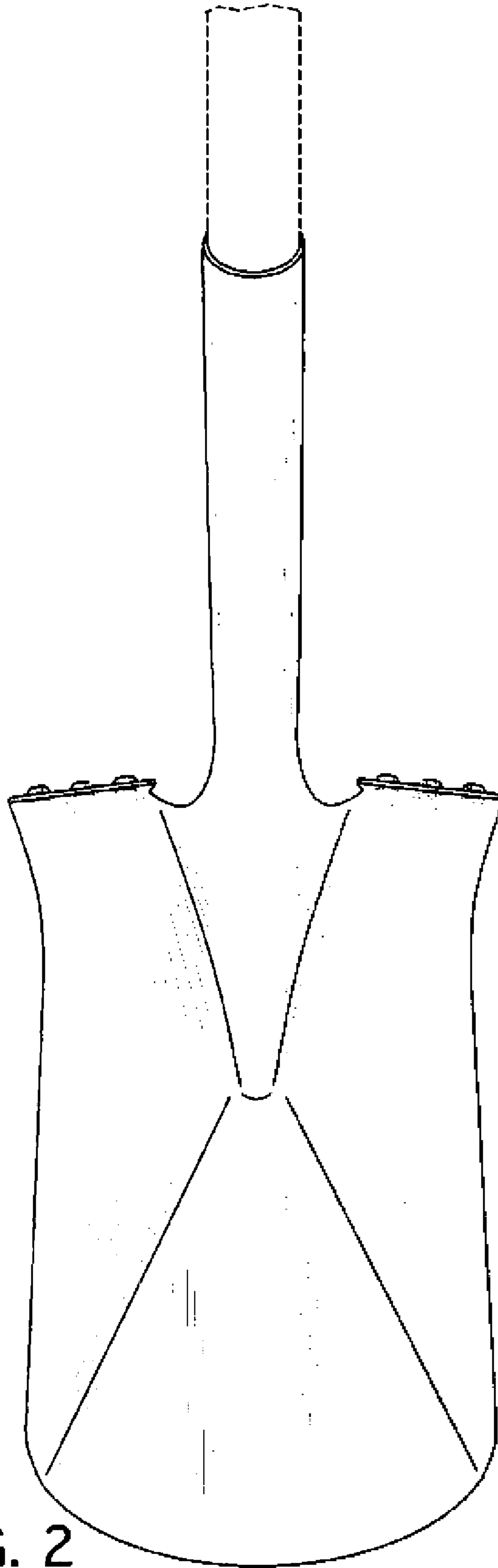

FIG. 2

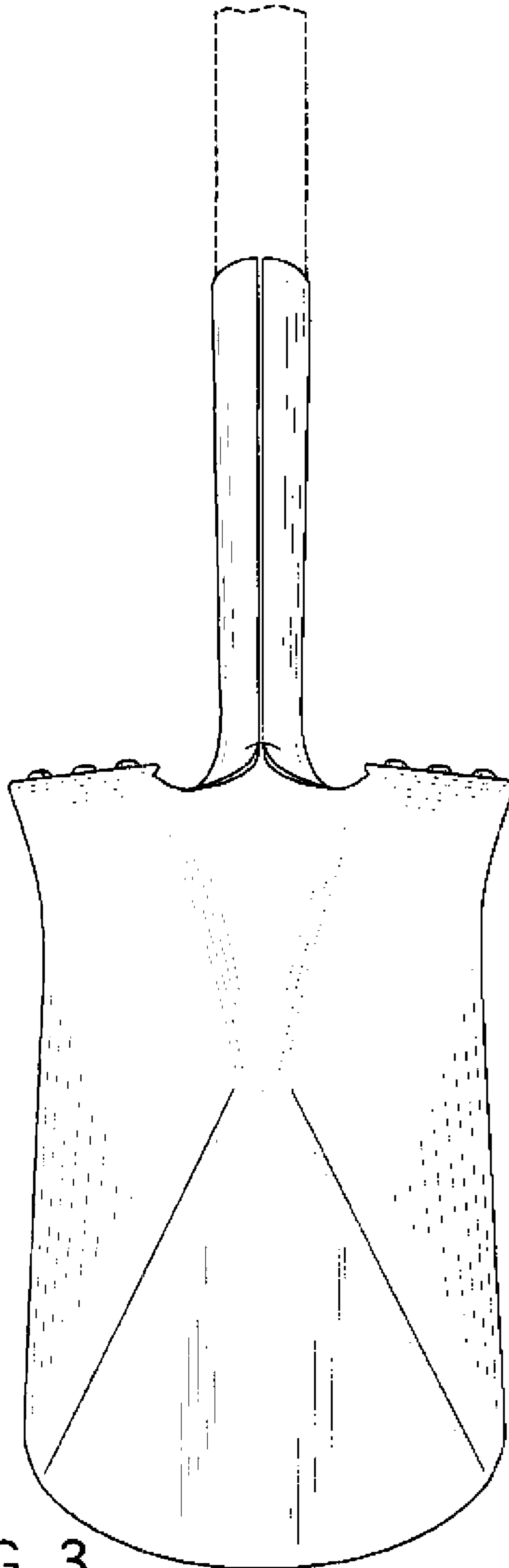

FIG. 3

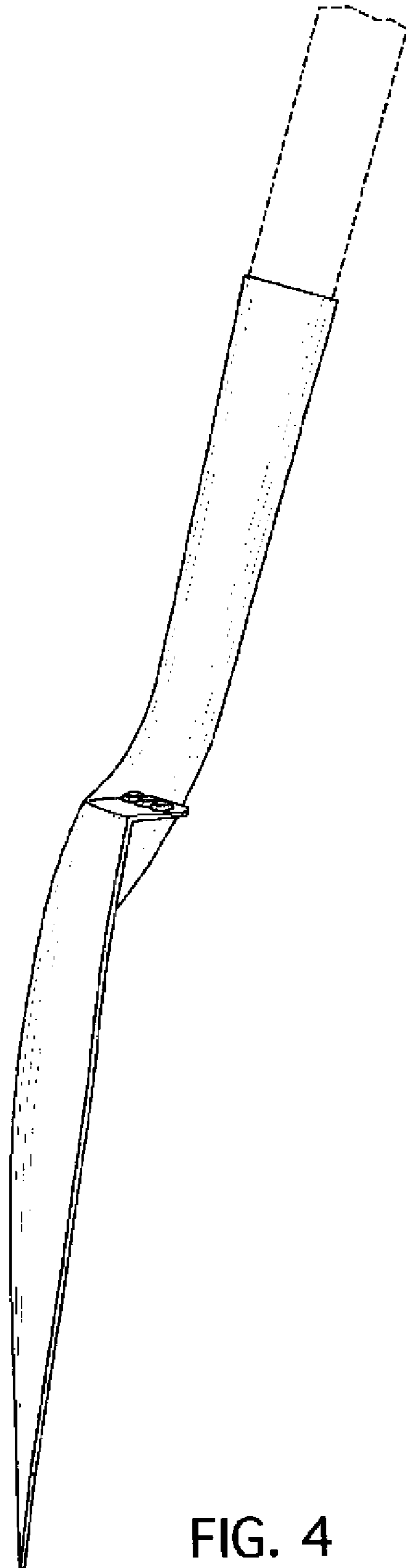

FIG. 4

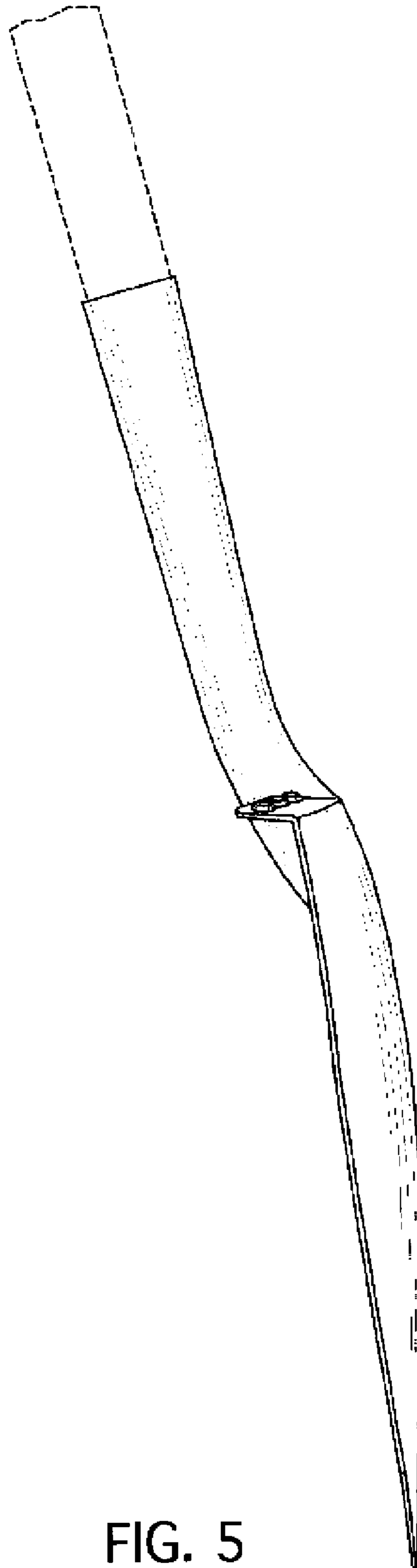

FIG. 5

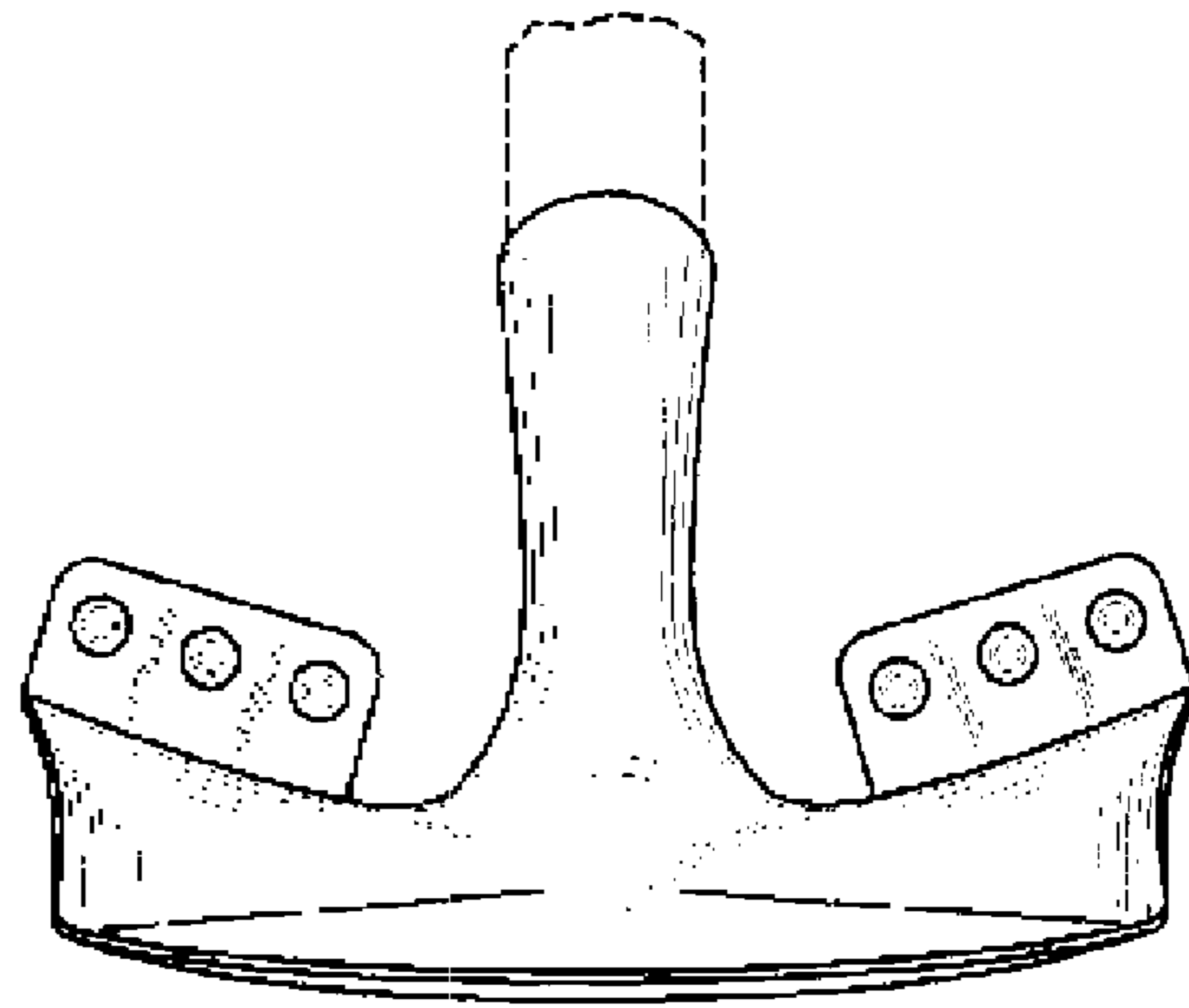

FIG. 6

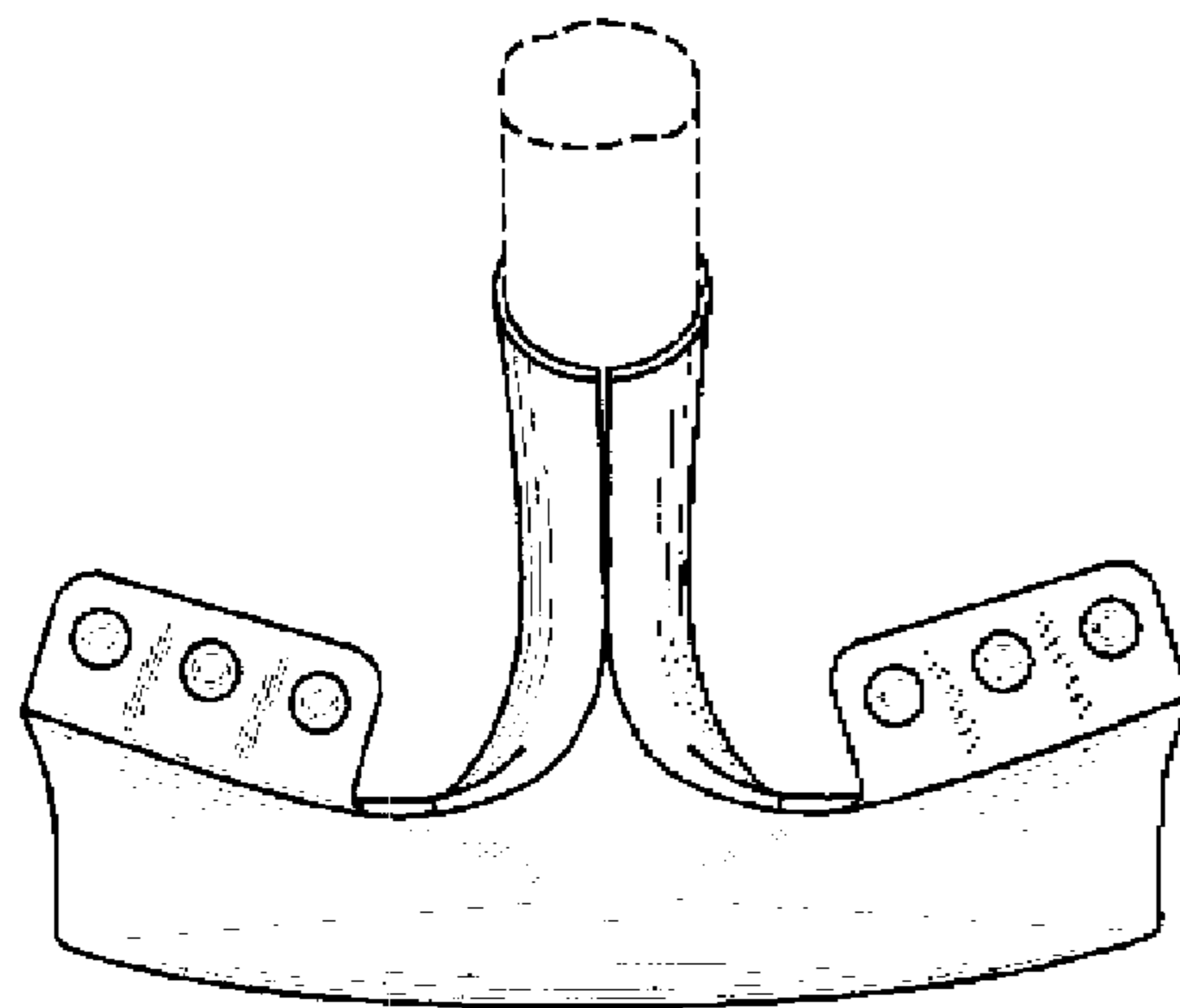

FIG. 7