



US00D699516S

(12) **United States Design Patent**
Kim et al.

(10) **Patent No.:** **US D699,516 S**
(45) **Date of Patent:** **** Feb. 18, 2014**

(54) **WATER BOTTLE**

(71) Applicants: **Sunny Kim**, Astoria, NY (US); **Conor McNamara**, Montclair, NJ (US)

(72) Inventors: **Sunny Kim**, Astoria, NY (US); **Conor McNamara**, Montclair, NJ (US)

(73) Assignee: **Helen of Troy Limited**, St. Michael (BB)

(**) Term: **14 Years**

(21) Appl. No.: **29/451,259**

(22) Filed: **Mar. 29, 2013**

(51) **LOC (10) Cl.** **07-01**

(52) **U.S. Cl.**
USPC **D7/510**; D7/511; D9/502

(58) **Field of Classification Search**
USPC D7/396.2, 300.1, 510, 511, 532, 523,
D7/531, 513, 608; D9/743, 502, 504;
215/209; 220/720, 715, 281, 739, 23.4,
220/23.8; 206/503, 501
See application file for complete search history.

(56) **References Cited**

U.S. PATENT DOCUMENTS

D31,681 S * 10/1899 Millon D9/558
1,884,665 A * 10/1932 Greiner 228/124.1

D354,915 S * 1/1995 Schneider et al. D9/504
D553,914 S * 10/2007 Wahl D7/608
D601,311 S * 9/2009 DeSeguirant, Jr. D30/160
D608,202 S * 1/2010 Caroen et al. D9/500
D621,220 S * 8/2010 Lown et al. D7/510
D627,601 S * 11/2010 Eyal D7/510
D658,450 S * 5/2012 Ying D7/608
D672,609 S * 12/2012 Aziz et al. D7/510
D684,805 S * 6/2013 Bjerre-Poulsen et al. D7/316
D689,332 S * 9/2013 Krasner D7/510

* cited by examiner

Primary Examiner — Marianne Pandozzi

(57) **CLAIM**

The ornamental design for a water bottle, as shown, and described.

DESCRIPTION

FIG. 1 is a left side view of the water bottle;
FIG. 2 is a right side view of the water bottle;
FIG. 3 is a back side view of the water bottle;
FIG. 4 is a front side view of the water bottle;
FIG. 5 is a top view of the water bottle;
FIG. 6 is a bottom view of the water bottle; and,
FIG. 7 is a perspective view of the water bottle.
The broken lines are for illustrative purposes only and form no part of the claimed design.

1 Claim, 7 Drawing Sheets

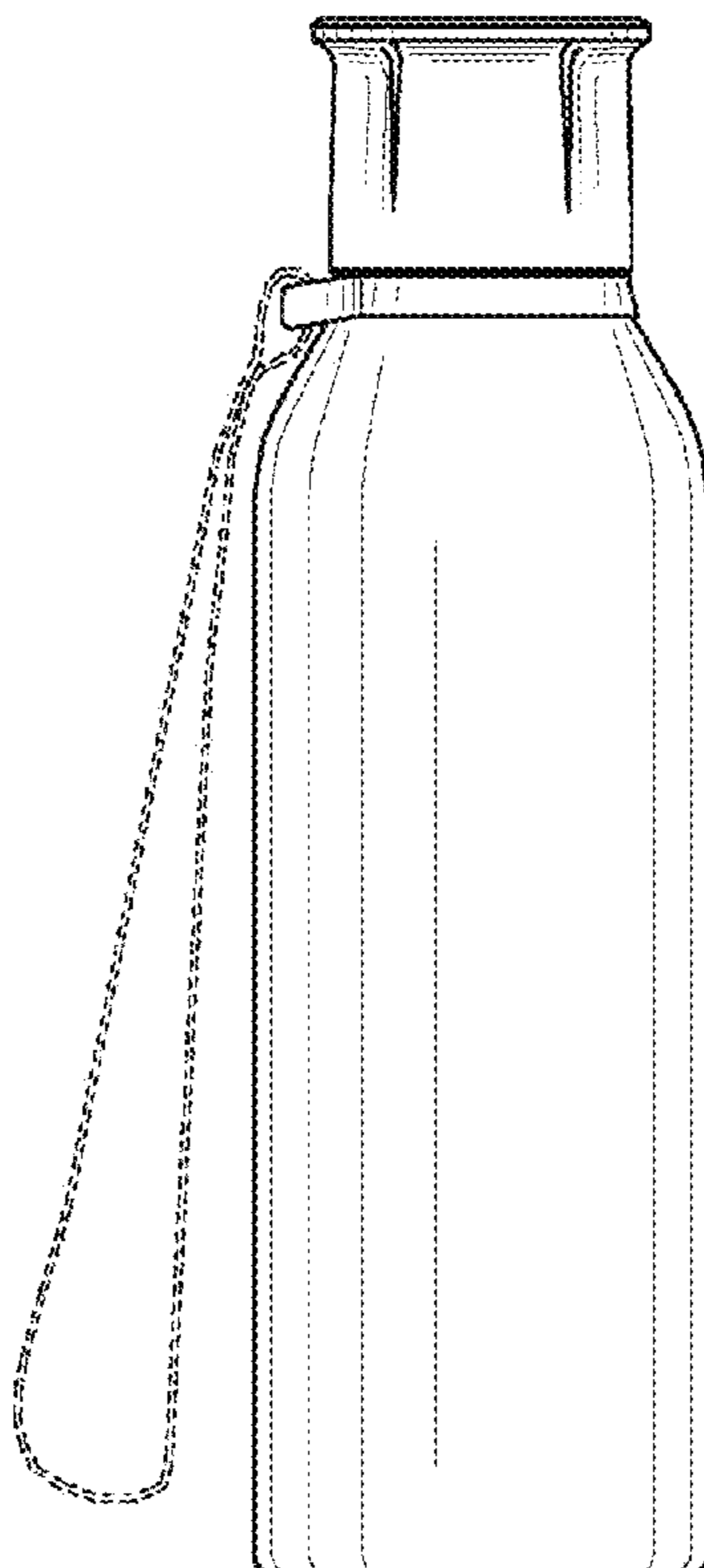

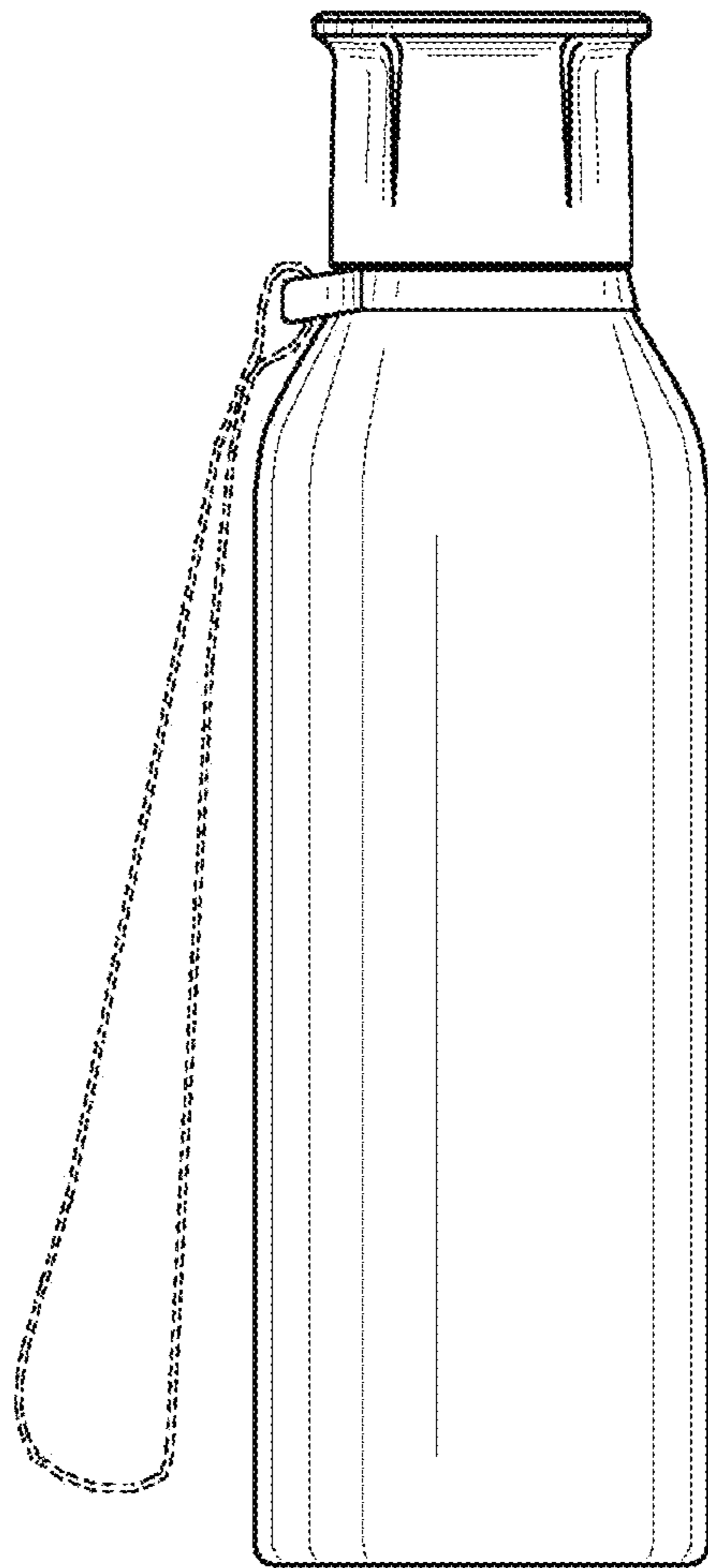

Figure 1

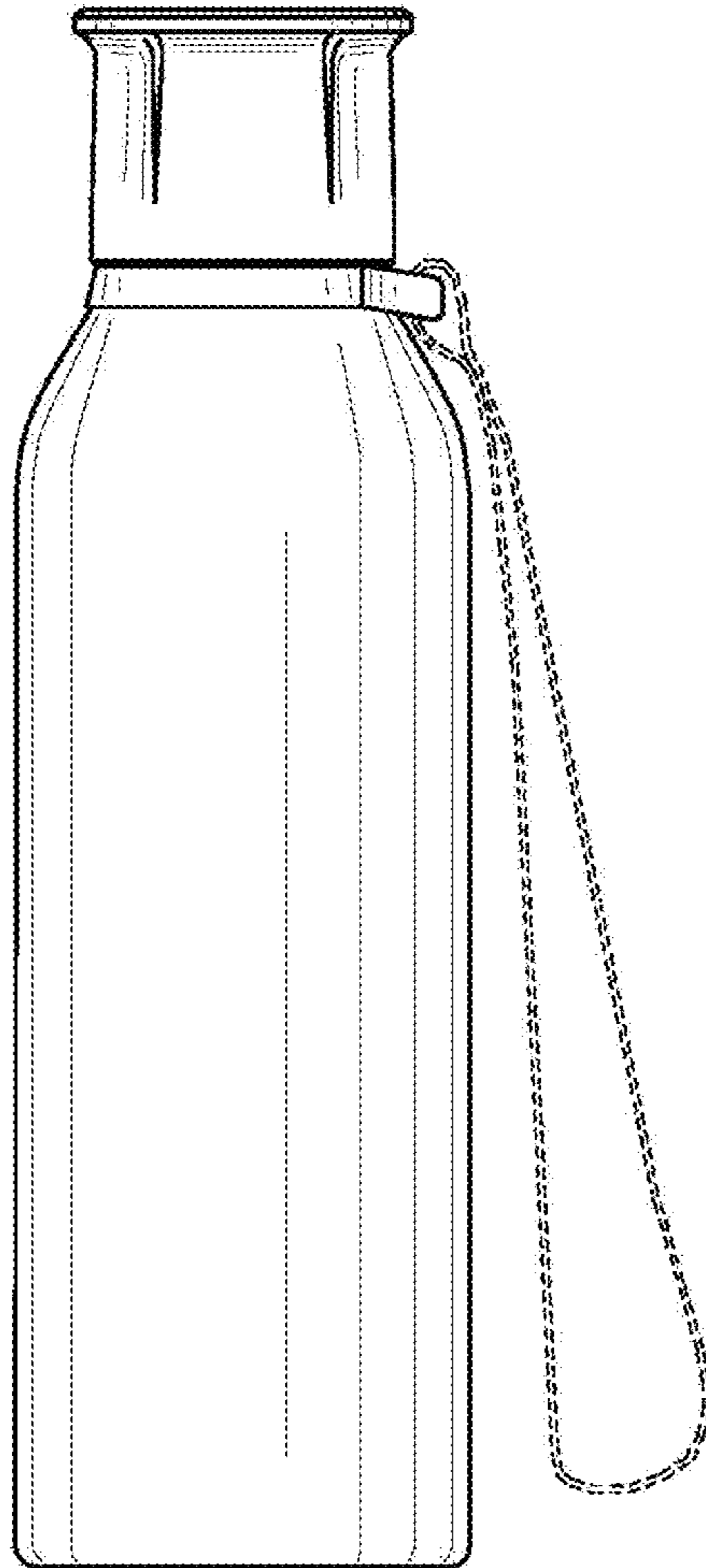

Figure 2

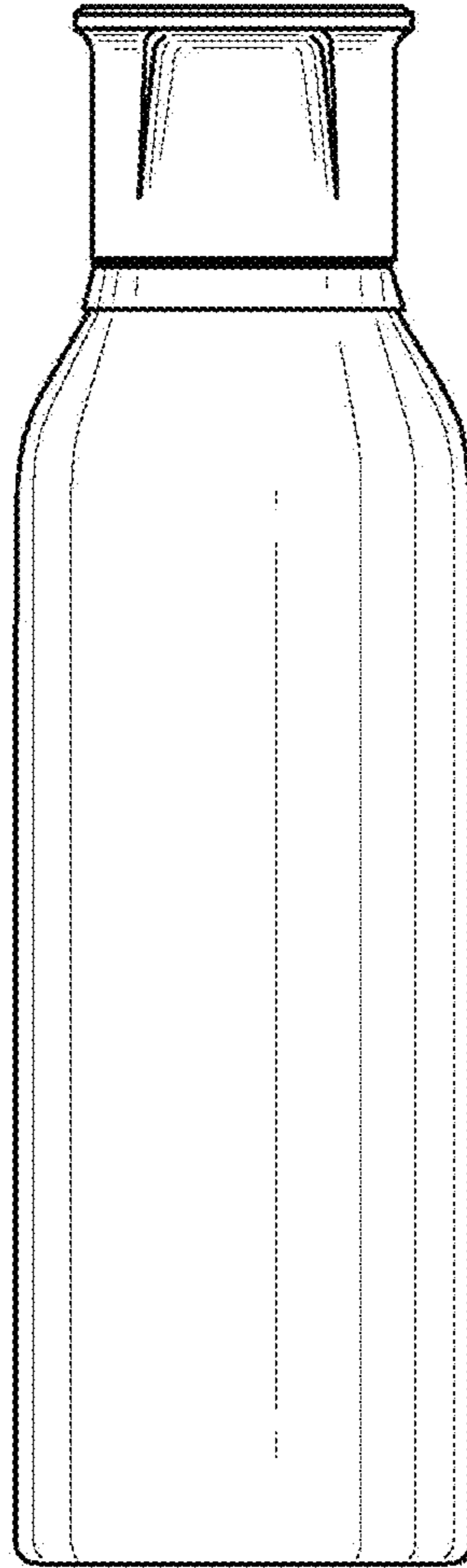

Figure 3

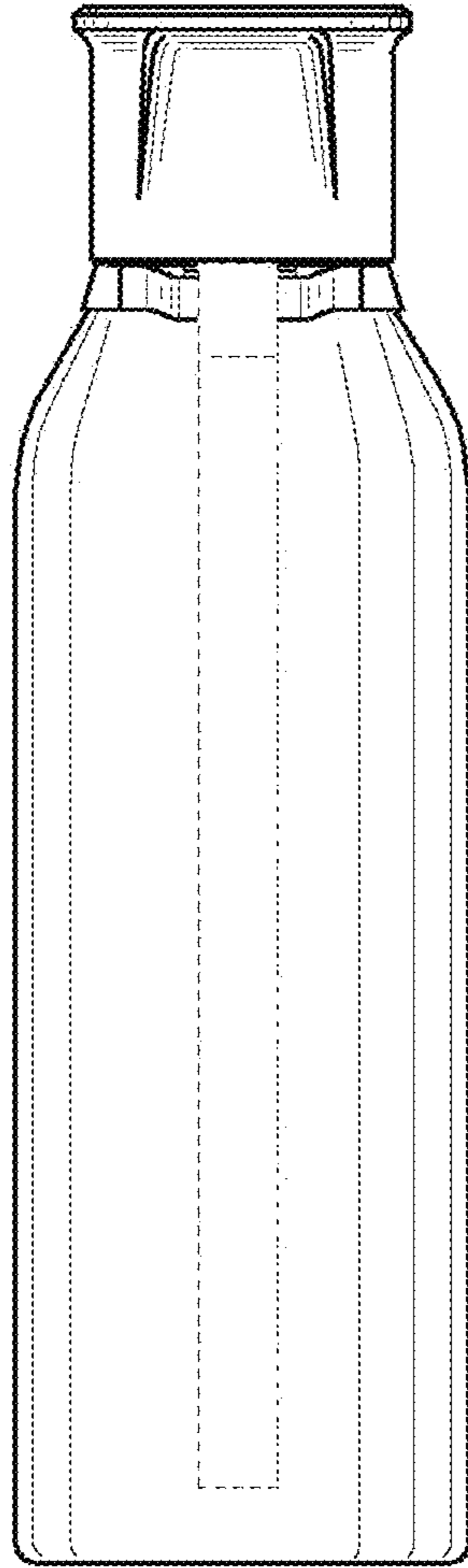

Figure 4

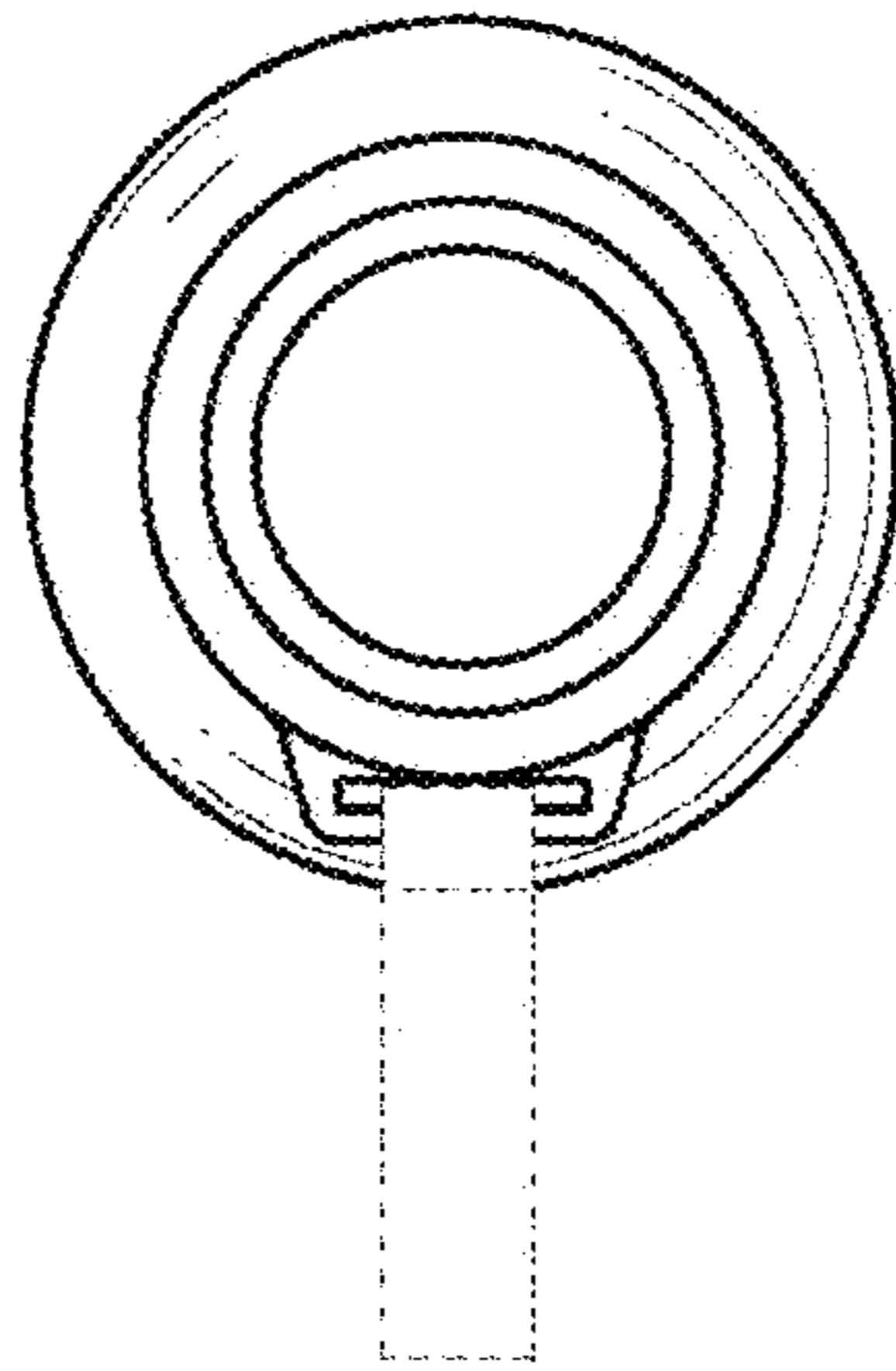

Figure 5

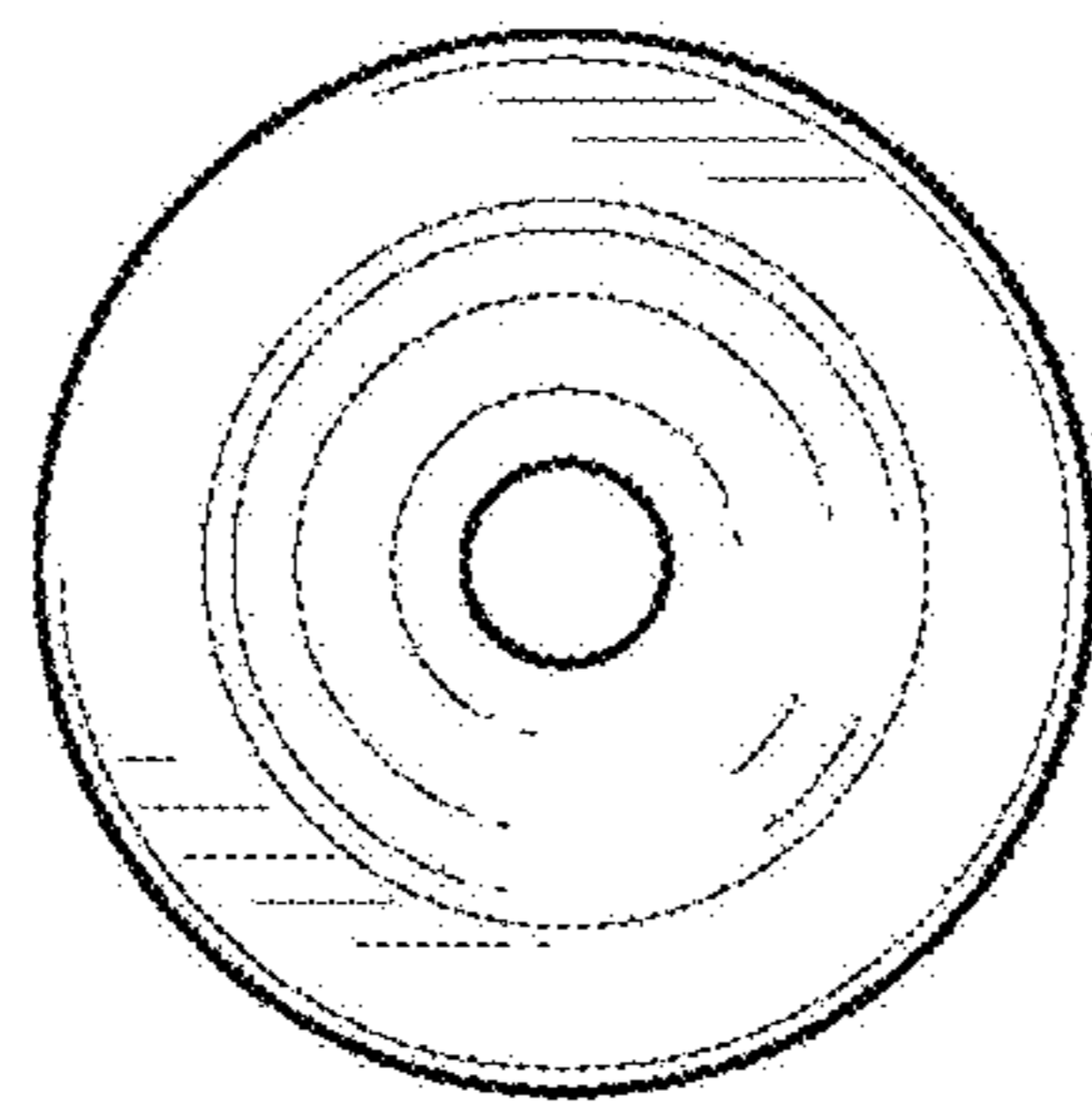

Figure 6

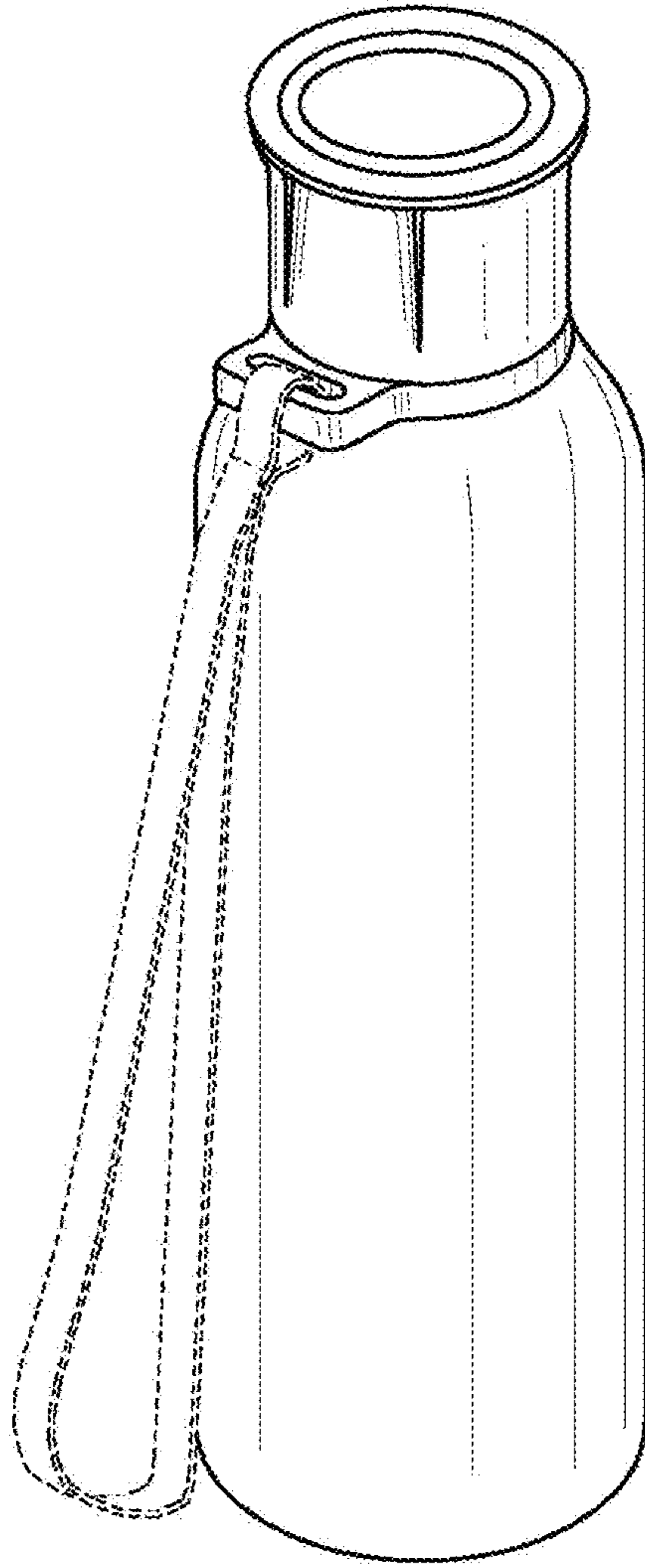

Figure 7