



US00D699473S

(12) **United States Design Patent**  
**Szczepanowski et al.**

(10) **Patent No.:** **US D699,473 S**  
(45) **Date of Patent:** **\*\* Feb. 18, 2014**

(54) **STAND FOR A RAZOR**

(71) Applicant: **The Gillette Company**, Boston, MA (US)

(72) Inventors: **Andrew Anthony Szczepanowski**, North Attleboro, MA (US); **Michael Frederick Palmer**, Cincinnati, OH (US); **Brandon Albert Lynne**, Daly City, CA (US); **David Scott Whetstone**, San Francisco, CA (US); **Karson Isaiah Shadley**, Oakland, CA (US)

(73) Assignee: **The Gillette Company**, Boston, MA (US)

(\*\*) Term: **14 Years**

(21) Appl. No.: **29/468,662**

(22) Filed: **Oct. 2, 2013**

(51) **LOC (10) Cl.** ..... **28-03**

(52) **U.S. Cl.**

USPC ..... **D6/526**

(58) **Field of Classification Search**

USPC ..... D6/526, 524, 540, 534, 528; 211/13.1, 211/70.6, 87.01, 89.01, 66, 86.01; 248/200, 248/205.5, 309.1, 314, 127, 176.1; D9/749; 206/208, 209, 228, 361, 362, 362.1, 206/362.2, 362.3

See application file for complete search history.

(56) **References Cited**

**U.S. PATENT DOCUMENTS**

D425,255 S \* 5/2000 Chen ..... D6/526  
D544,264 S \* 6/2007 Gallagher ..... D6/526

D576,436 S \* 9/2008 Provost et al. .... D6/526  
D634,955 S \* 3/2011 Cavazos Jimenez et al. .. D6/526  
D635,384 S \* 4/2011 Yoon ..... D6/526  
D677,090 S 3/2013 Floyd et al.  
D677,503 S 3/2013 Floyd et al.  
D683,561 S \* 6/2013 Floyd et al. .... D6/526

\* cited by examiner

*Primary Examiner* — Brian N Vinson

(74) *Attorney, Agent, or Firm* — Kevin C. Johnson; Steven W. Miller

(57) **CLAIM**

The ornamental design for a stand for a razor, as shown and described.

**DESCRIPTION**

FIG. 1 is a perspective view of a stand for a razor showing our new design;  
FIG. 2 is a front view thereof;  
FIG. 3 is a rear view thereof;  
FIG. 4 is a right side view thereof;  
FIG. 5 is a left side view thereof;  
FIG. 6 is a top view thereof; and  
FIG. 7 is a bottom view thereof;  
FIG. 8 is another perspective view thereof;  
FIG. 9 is a perspective view of a second embodiment of a stand for a razor showing our new design;  
FIG. 10 is a front view thereof;  
FIG. 11 is a rear view thereof;  
FIG. 12 is a right side view thereof;  
FIG. 13 is a left side view thereof;  
FIG. 14 is a top view thereof;  
FIG. 15 is a bottom view thereof; and  
FIG. 16 is another perspective view thereof.

**1 Claim, 16 Drawing Sheets**

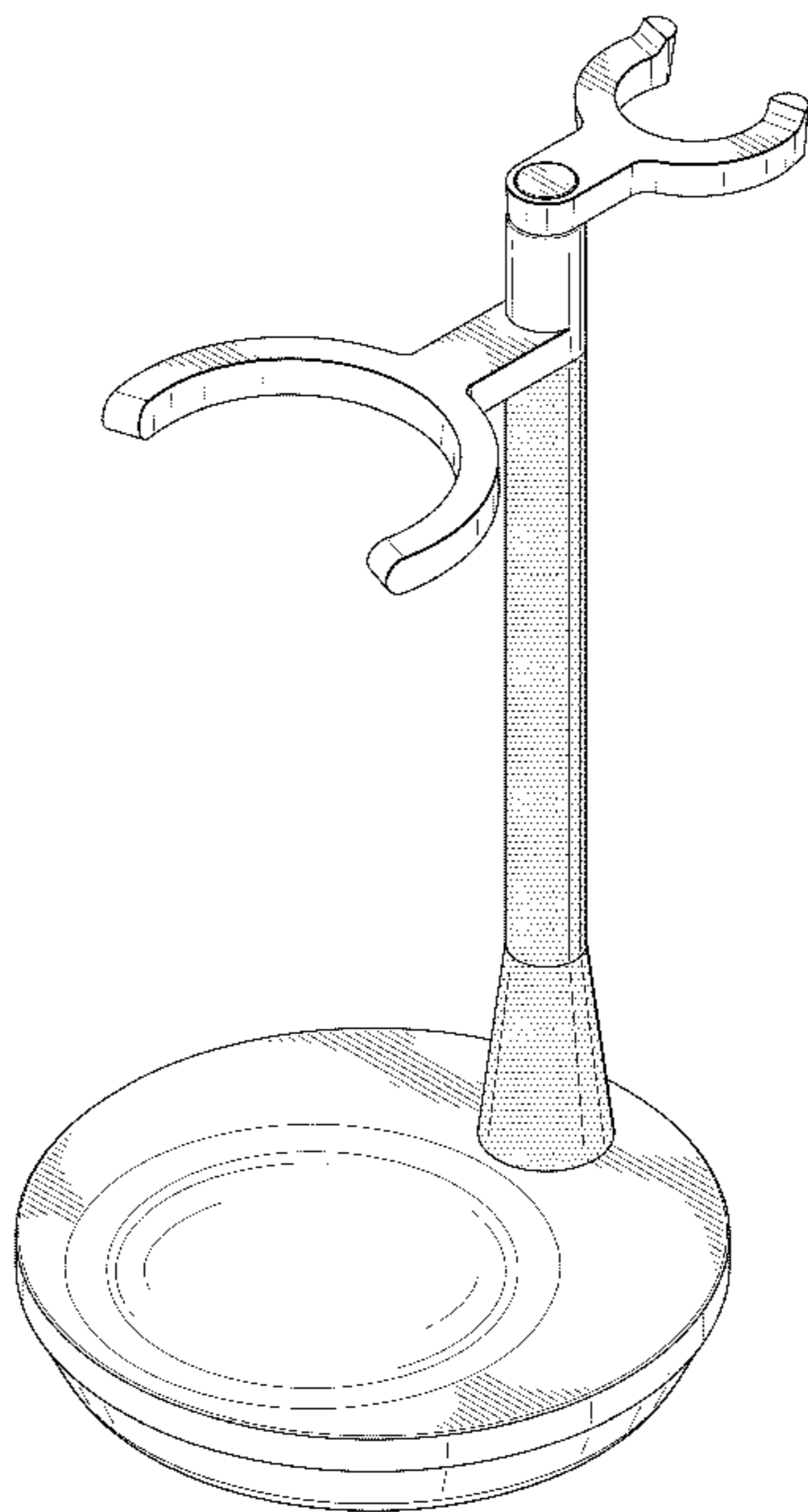
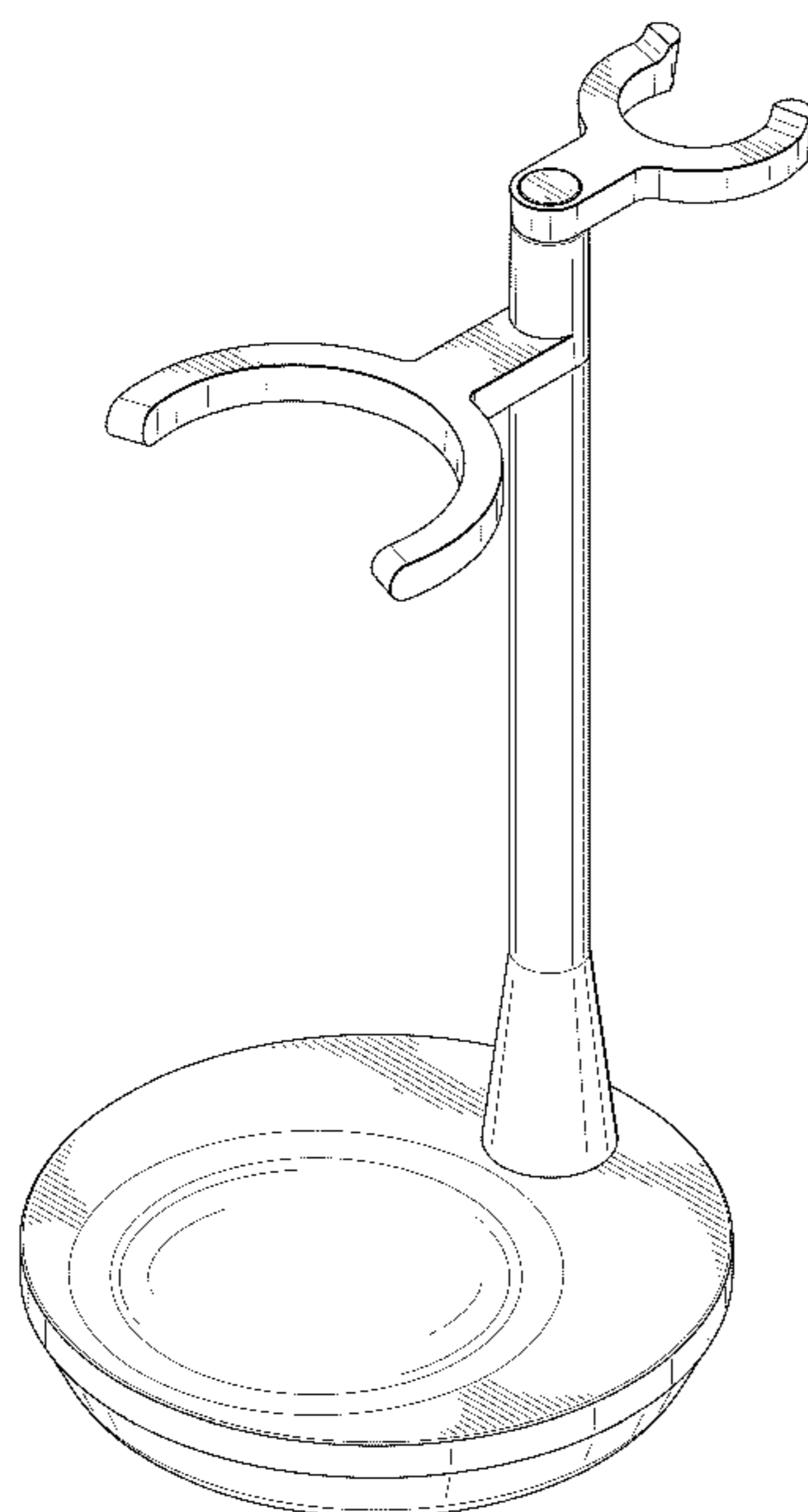

FIG. 1

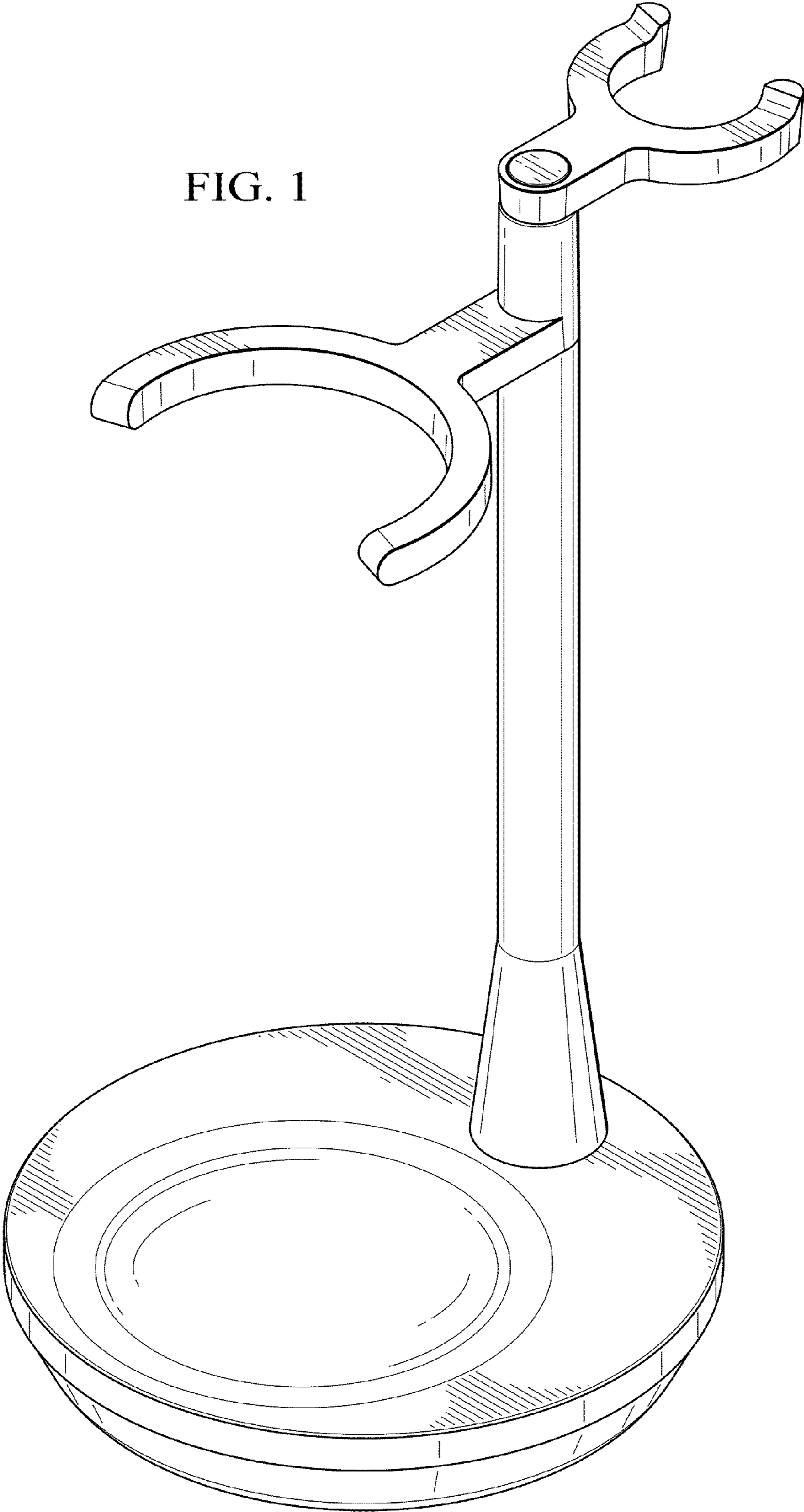

FIG. 2

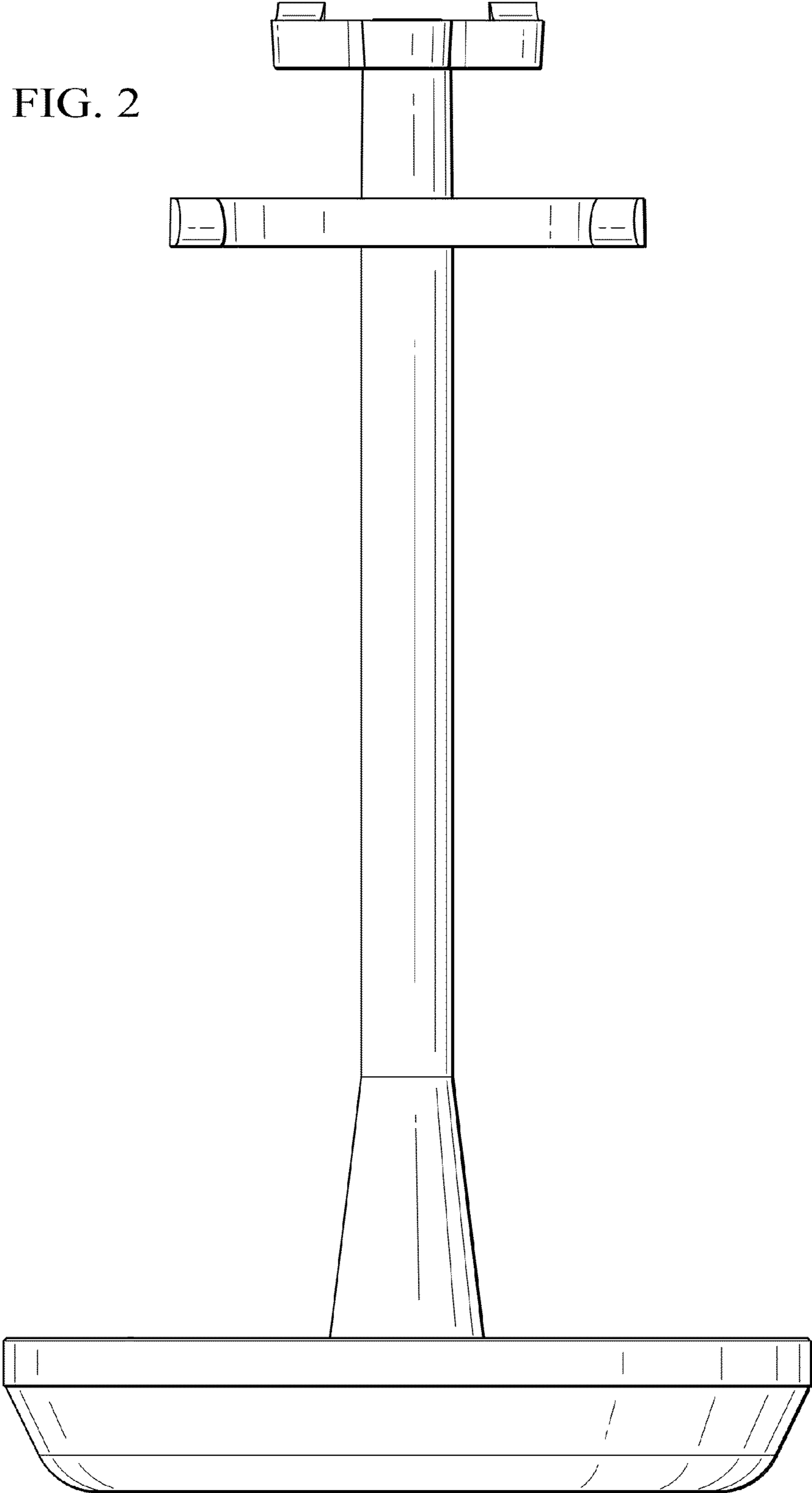

FIG. 3

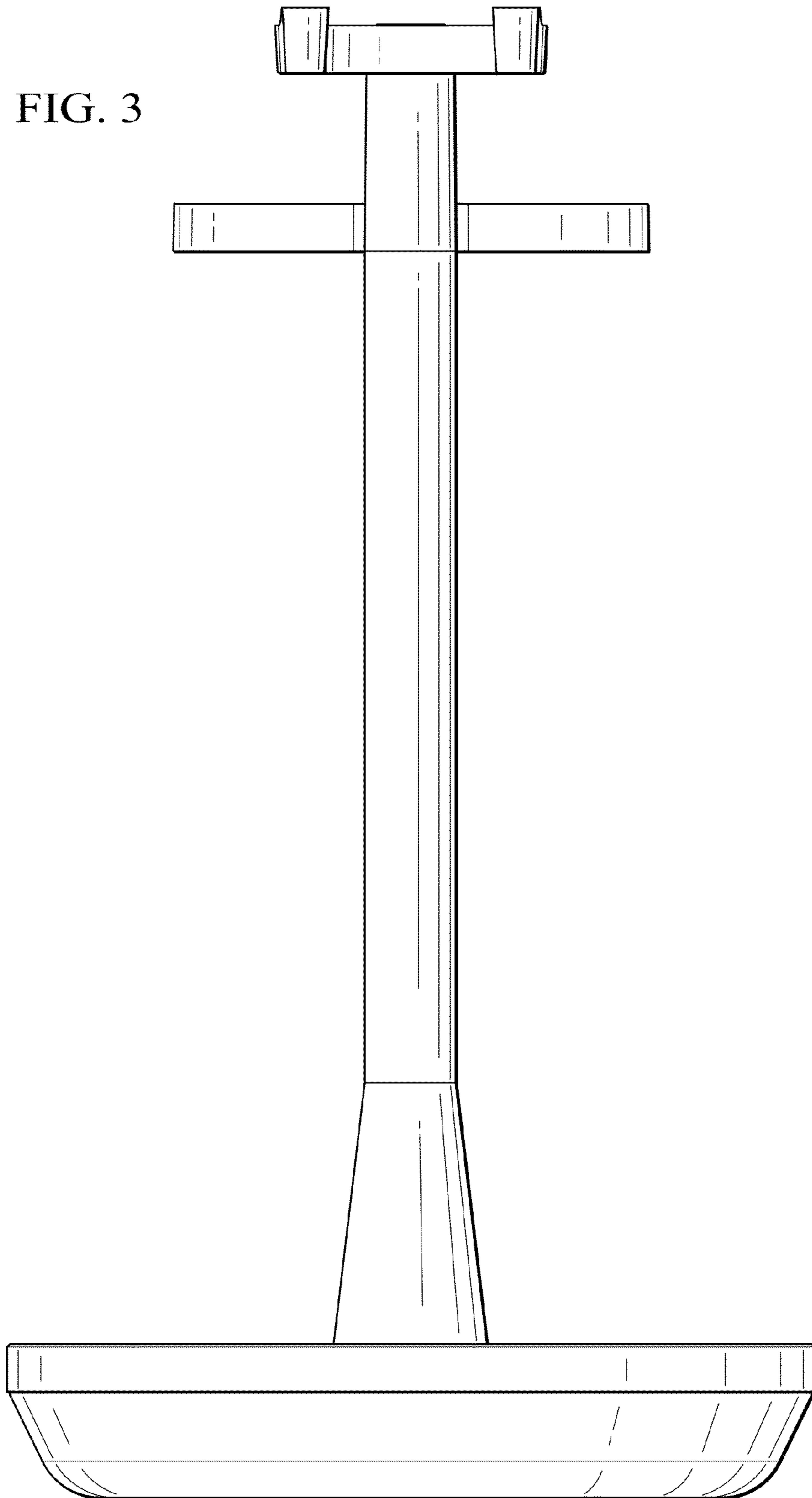
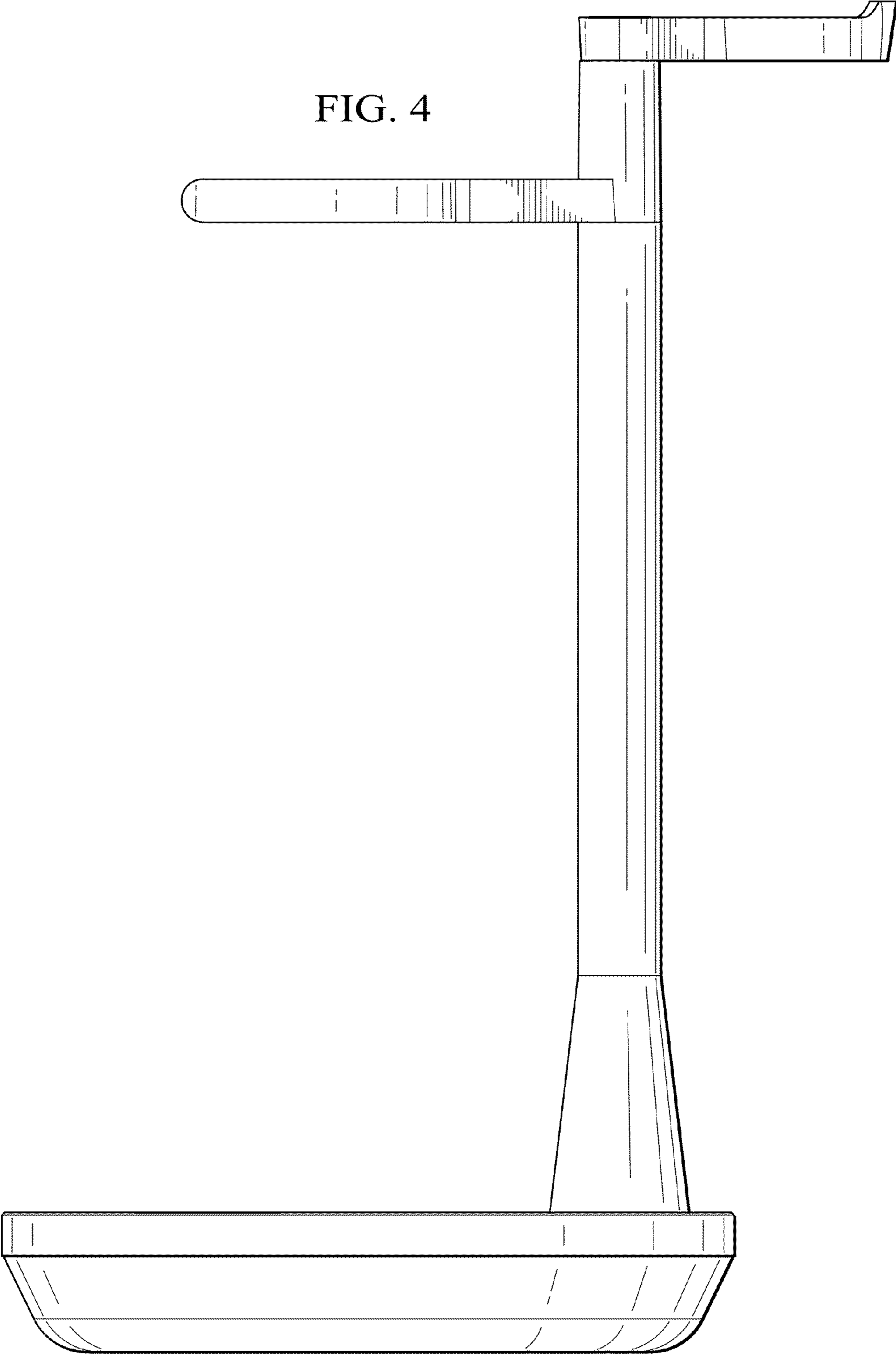
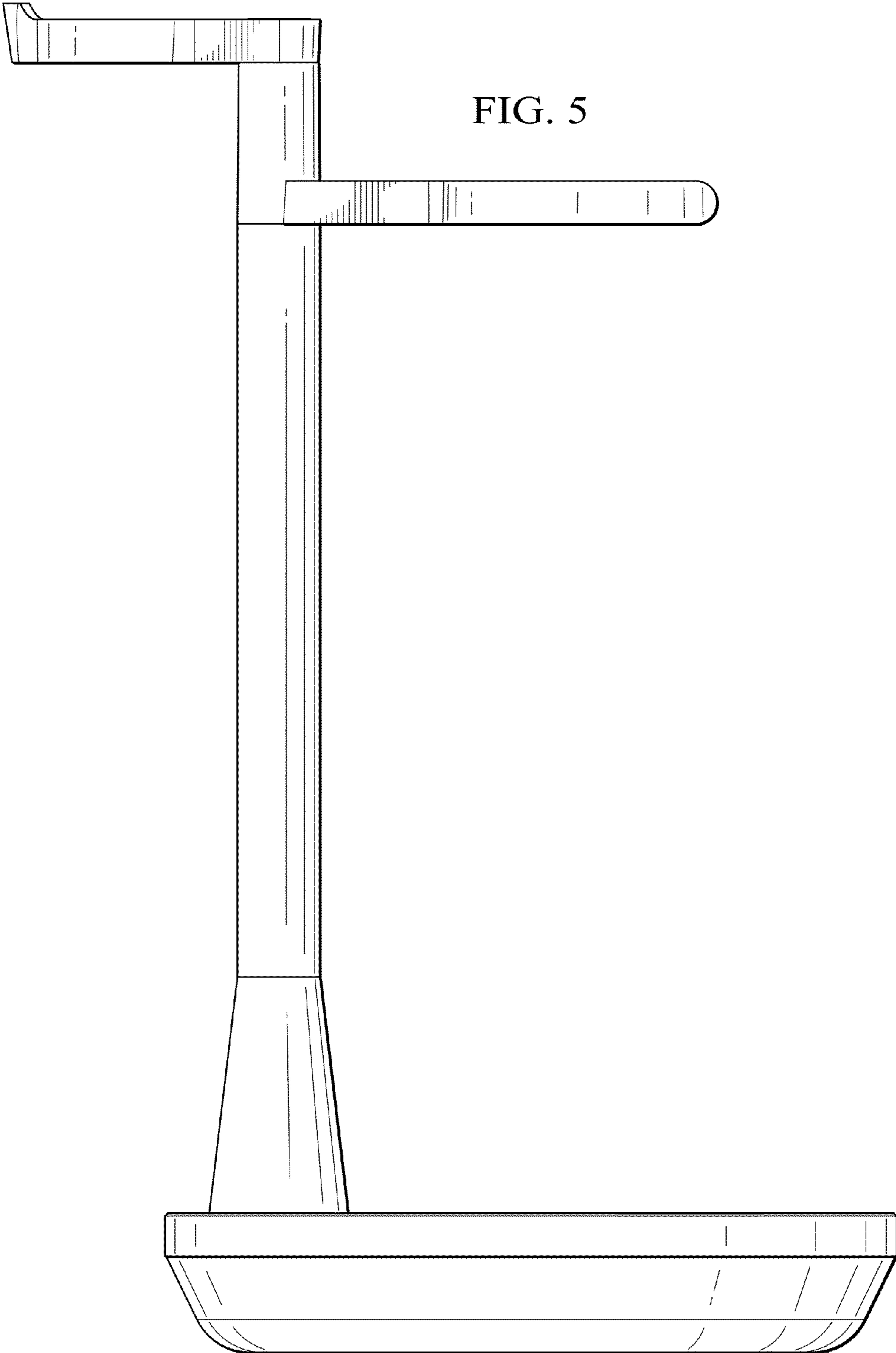

FIG. 4







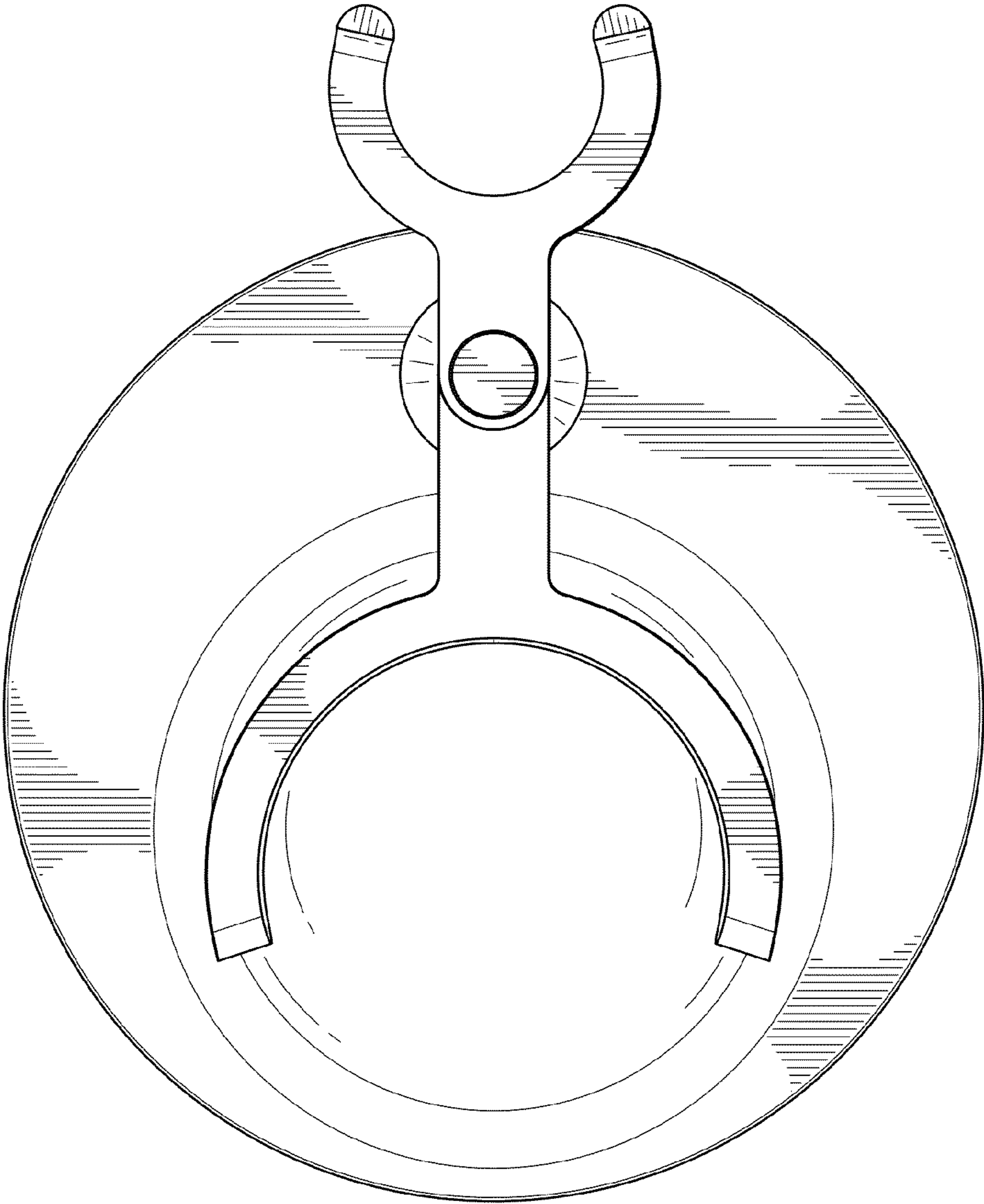
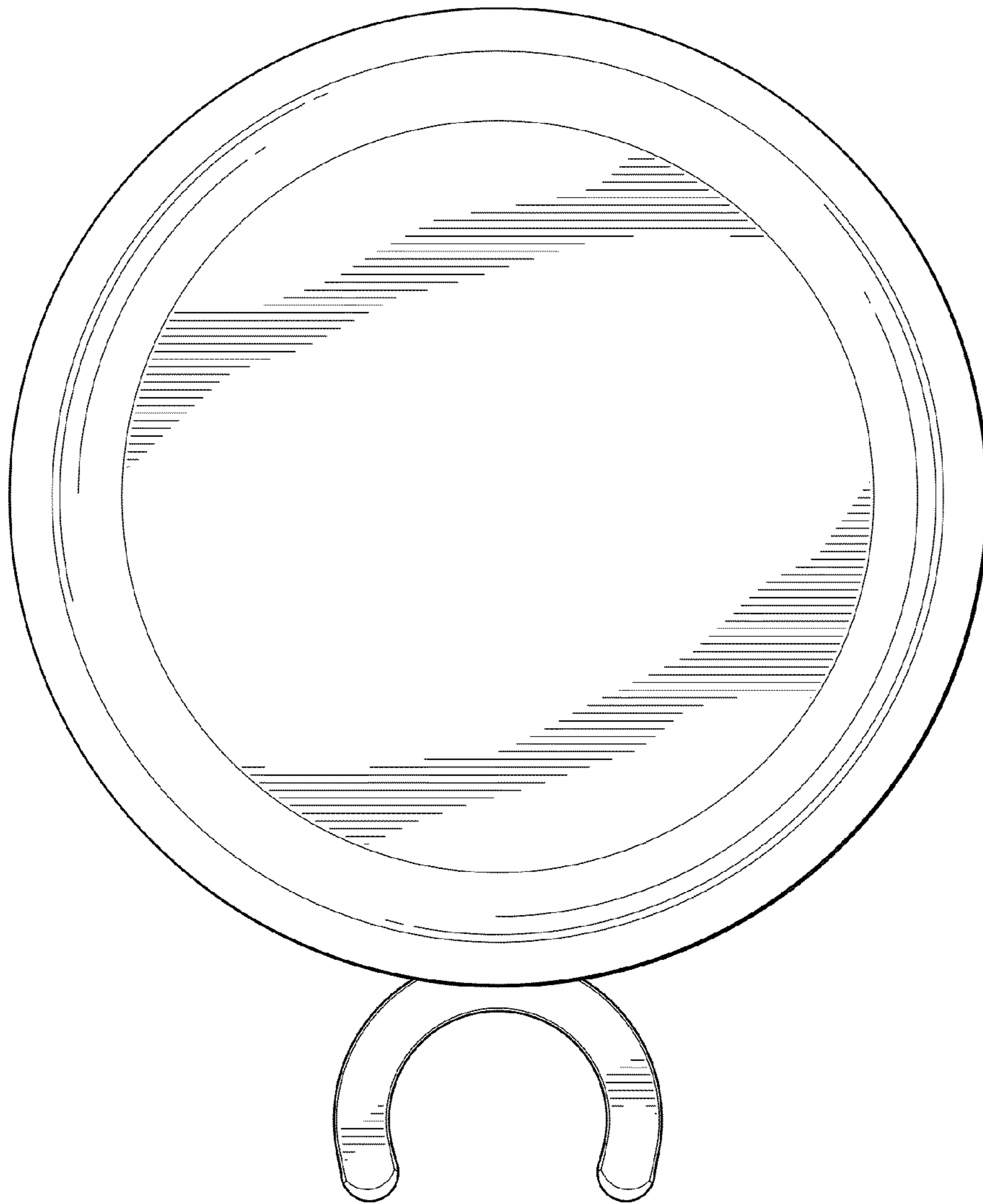

FIG. 6

FIG. 7





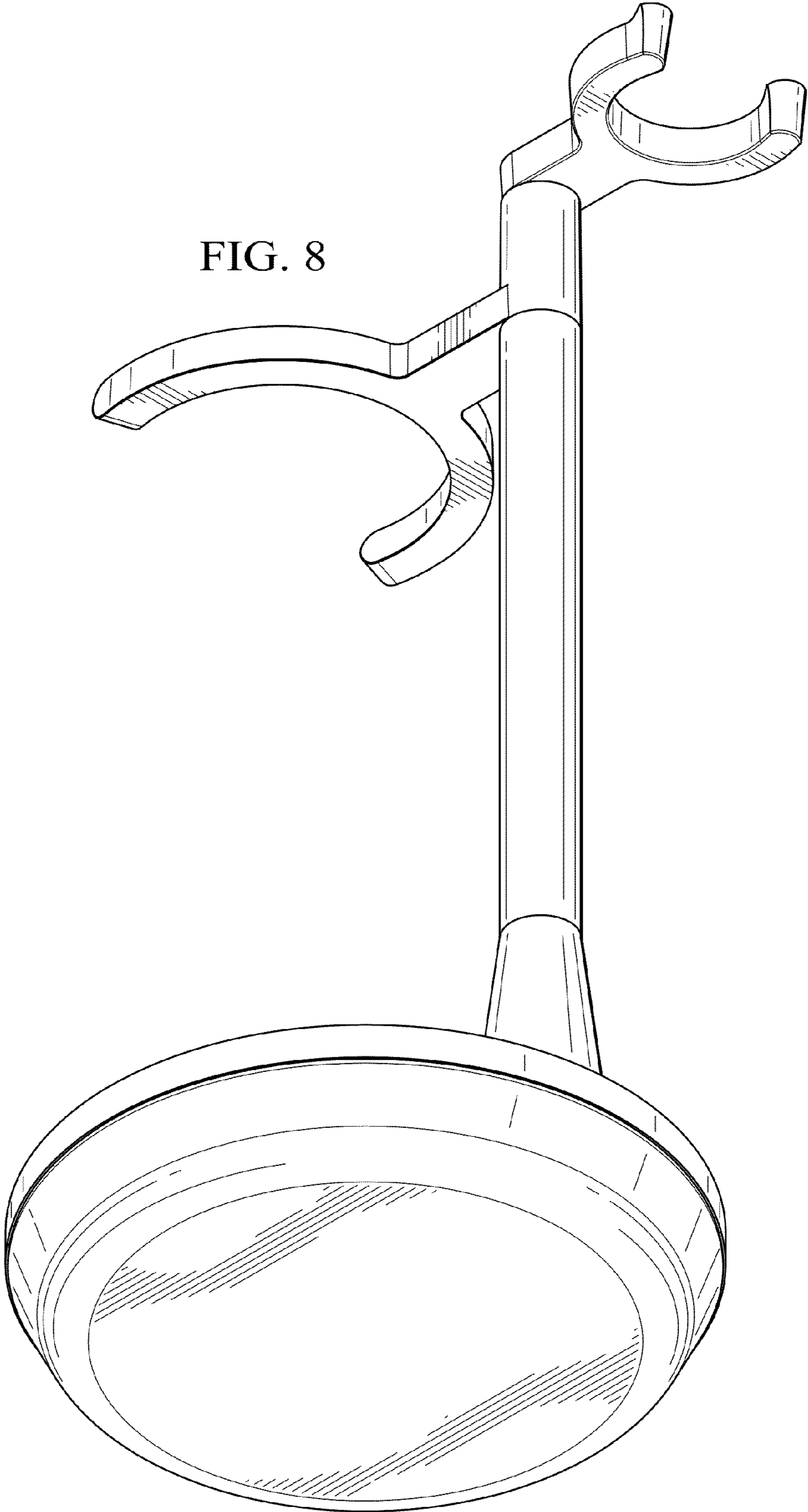

FIG. 8

FIG. 9

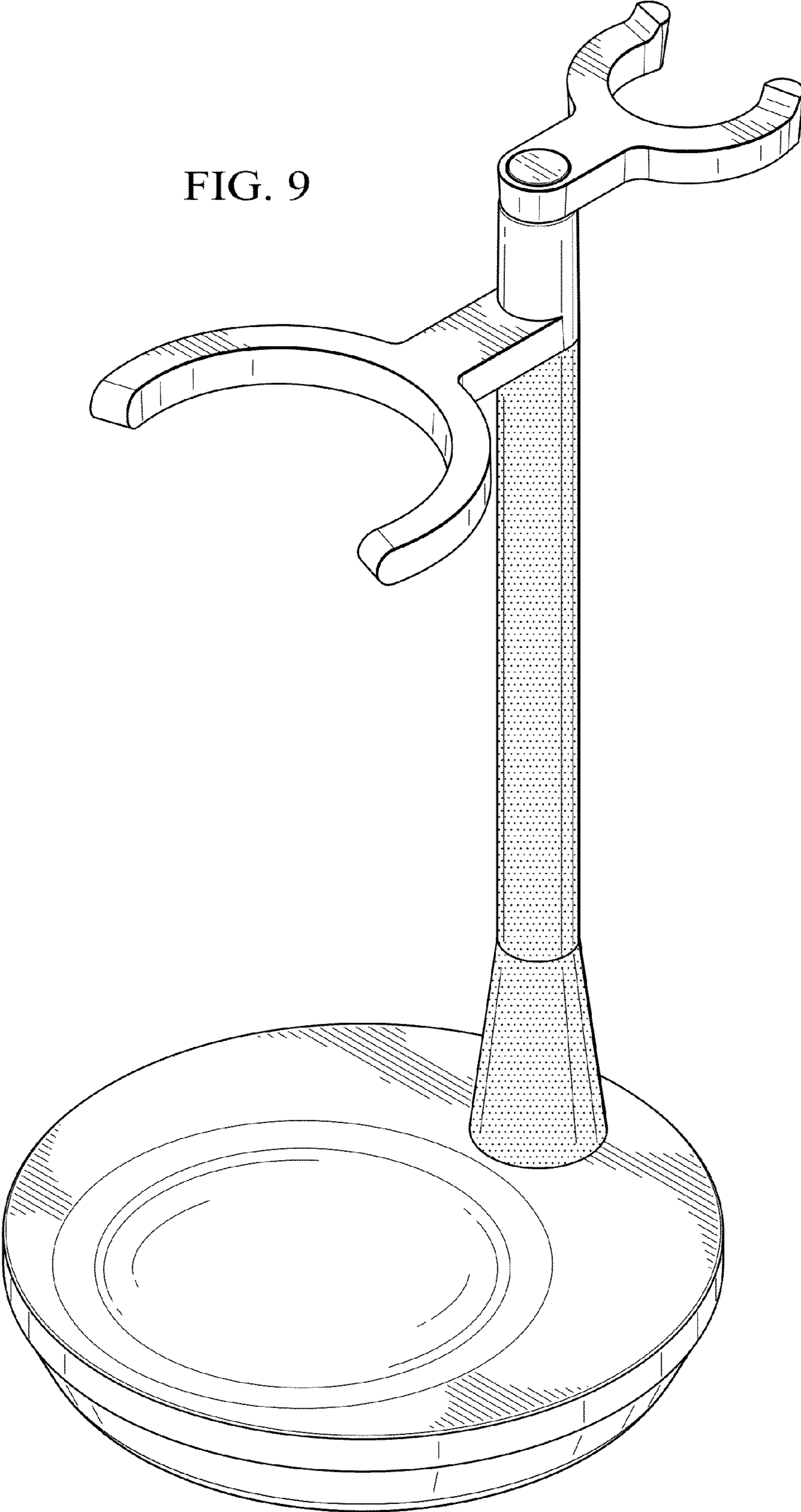

FIG. 10

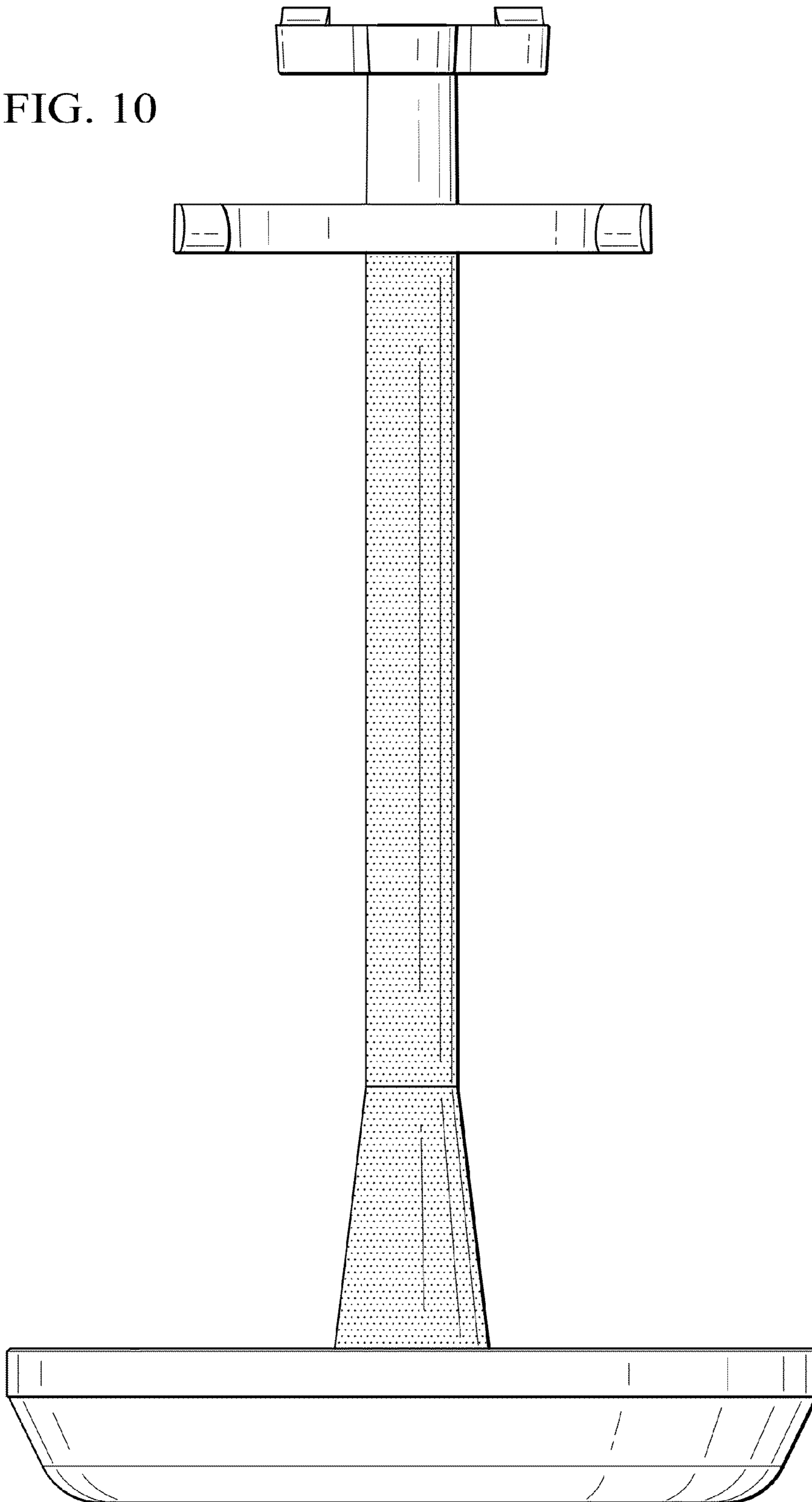

FIG. 11

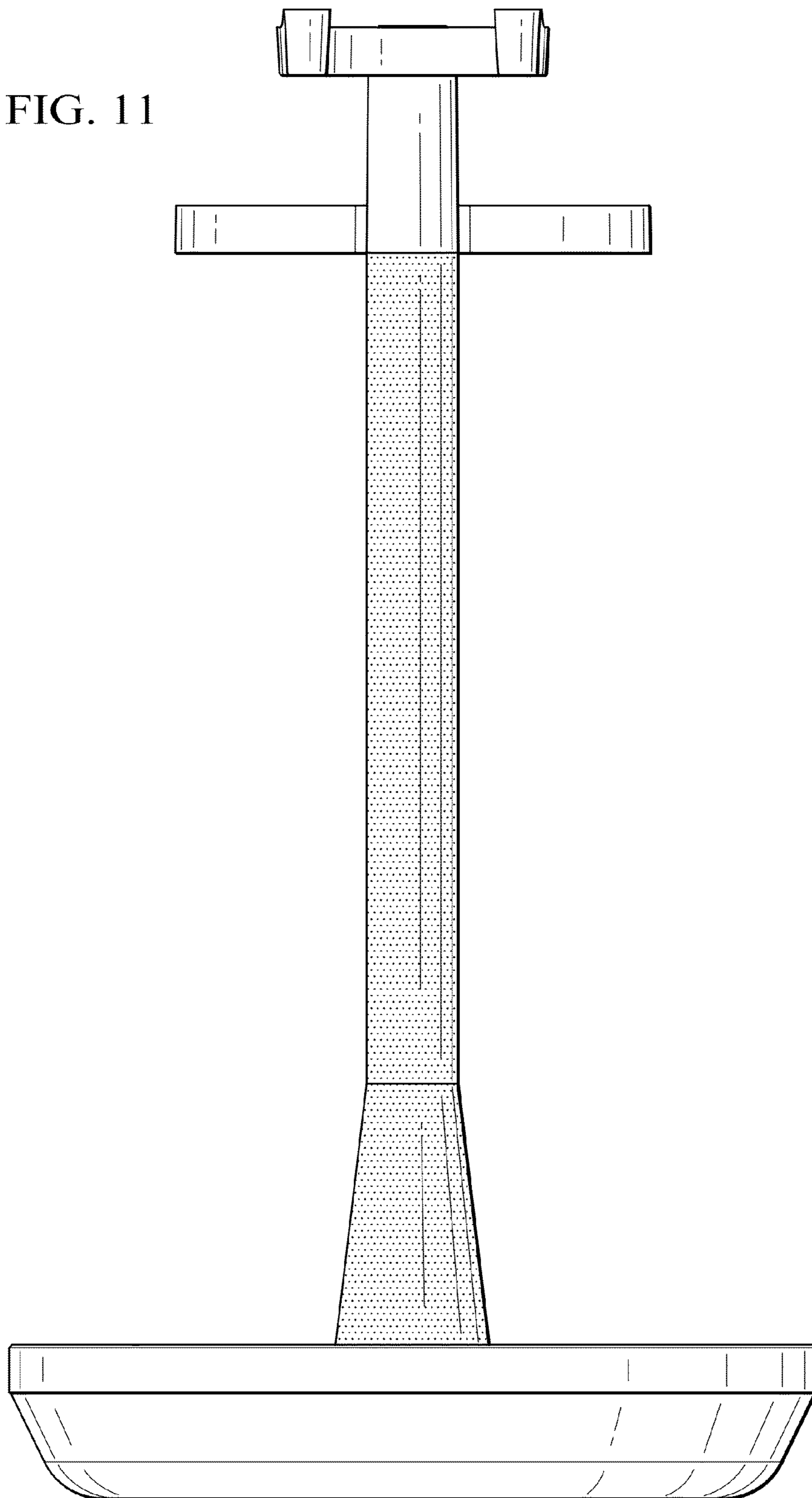
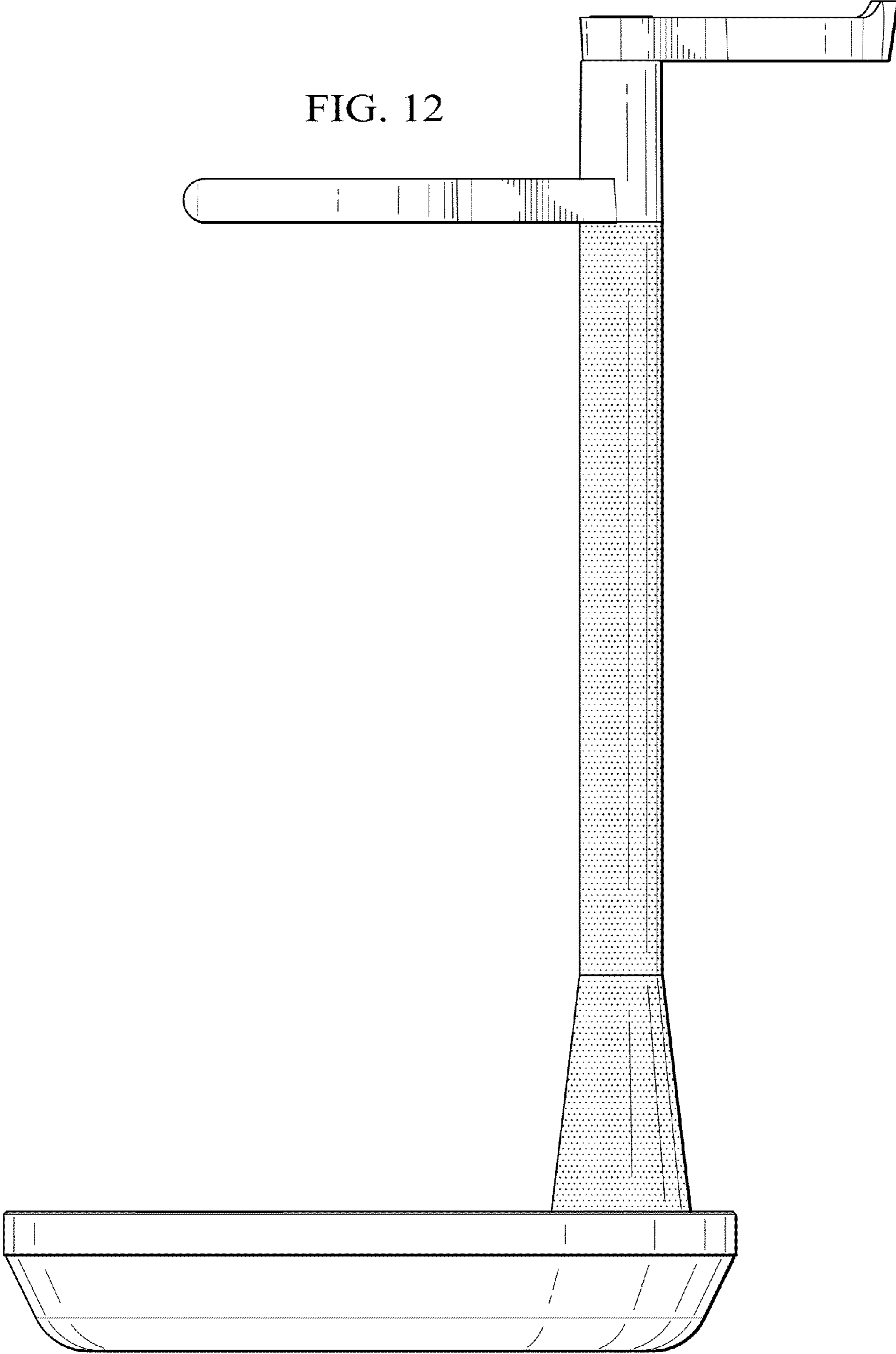
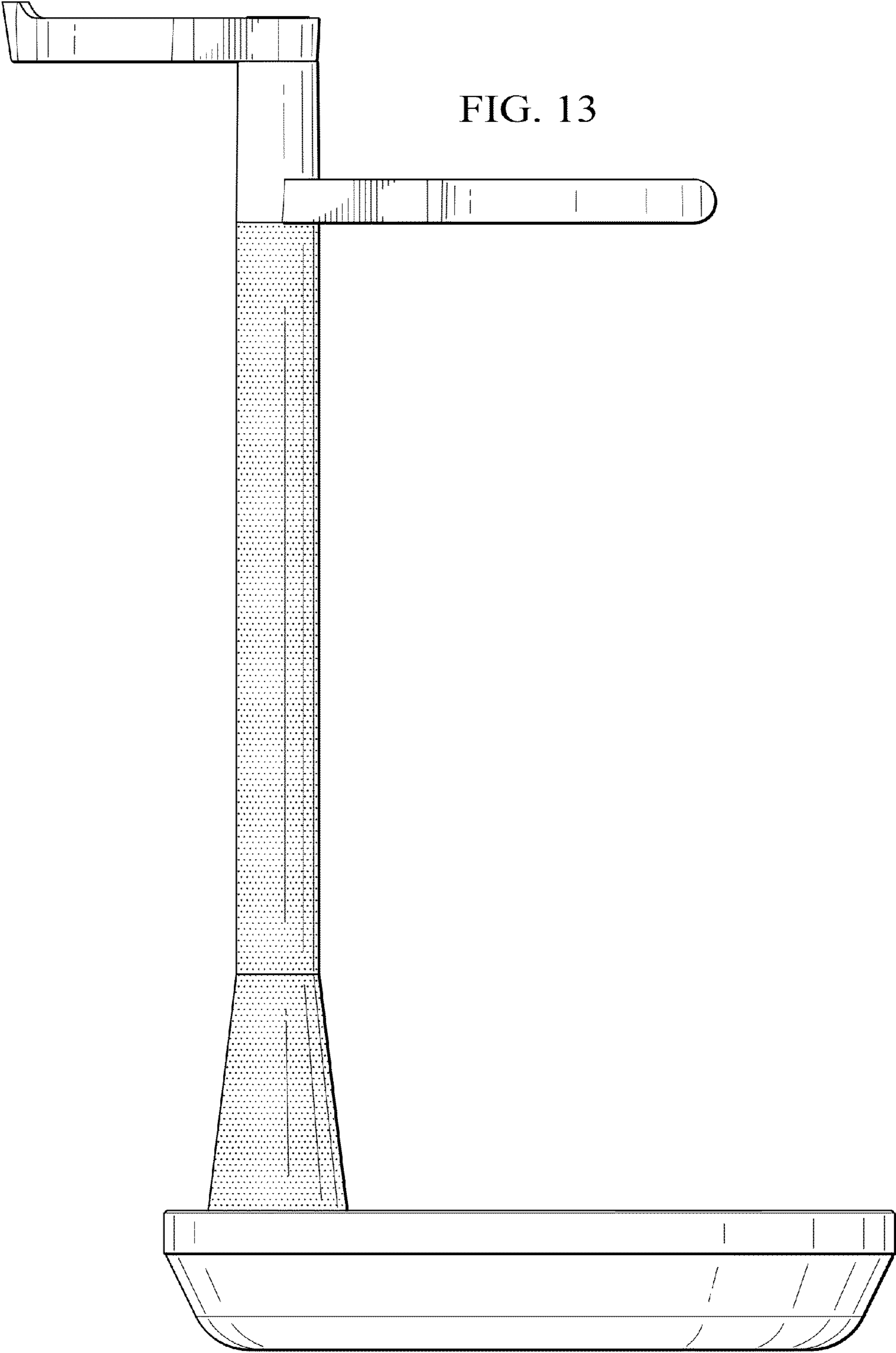

FIG. 12







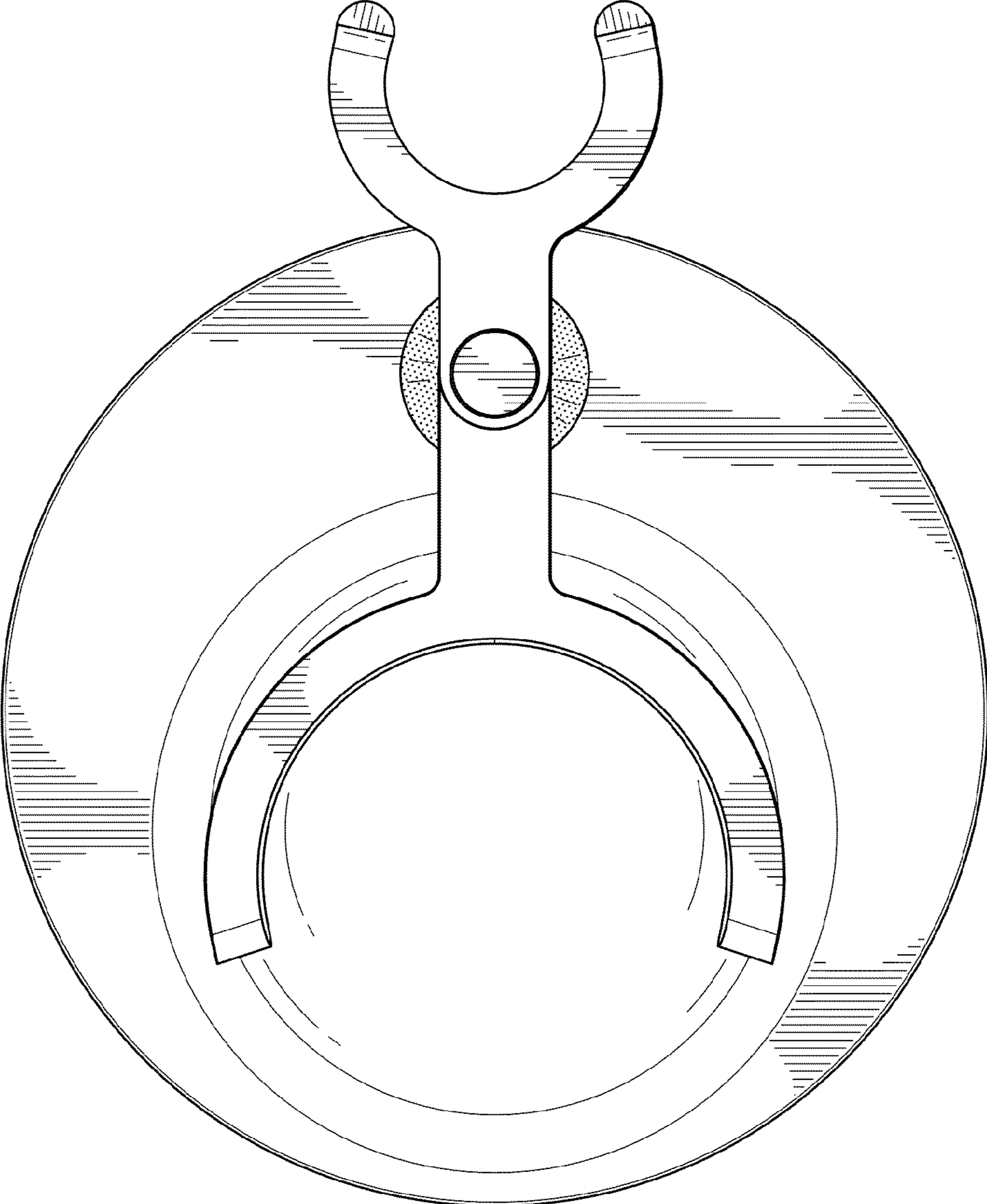
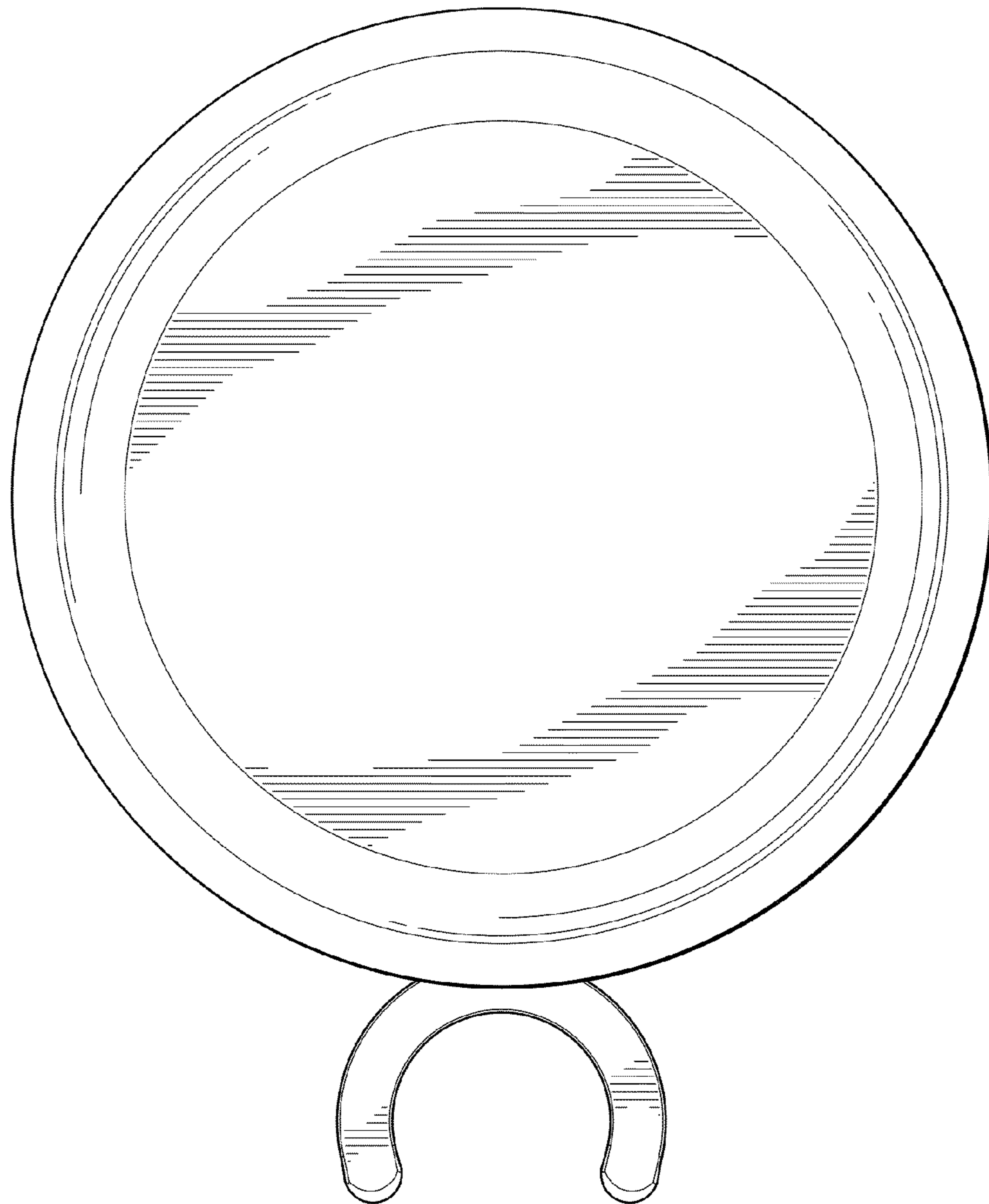

FIG. 14

FIG. 15



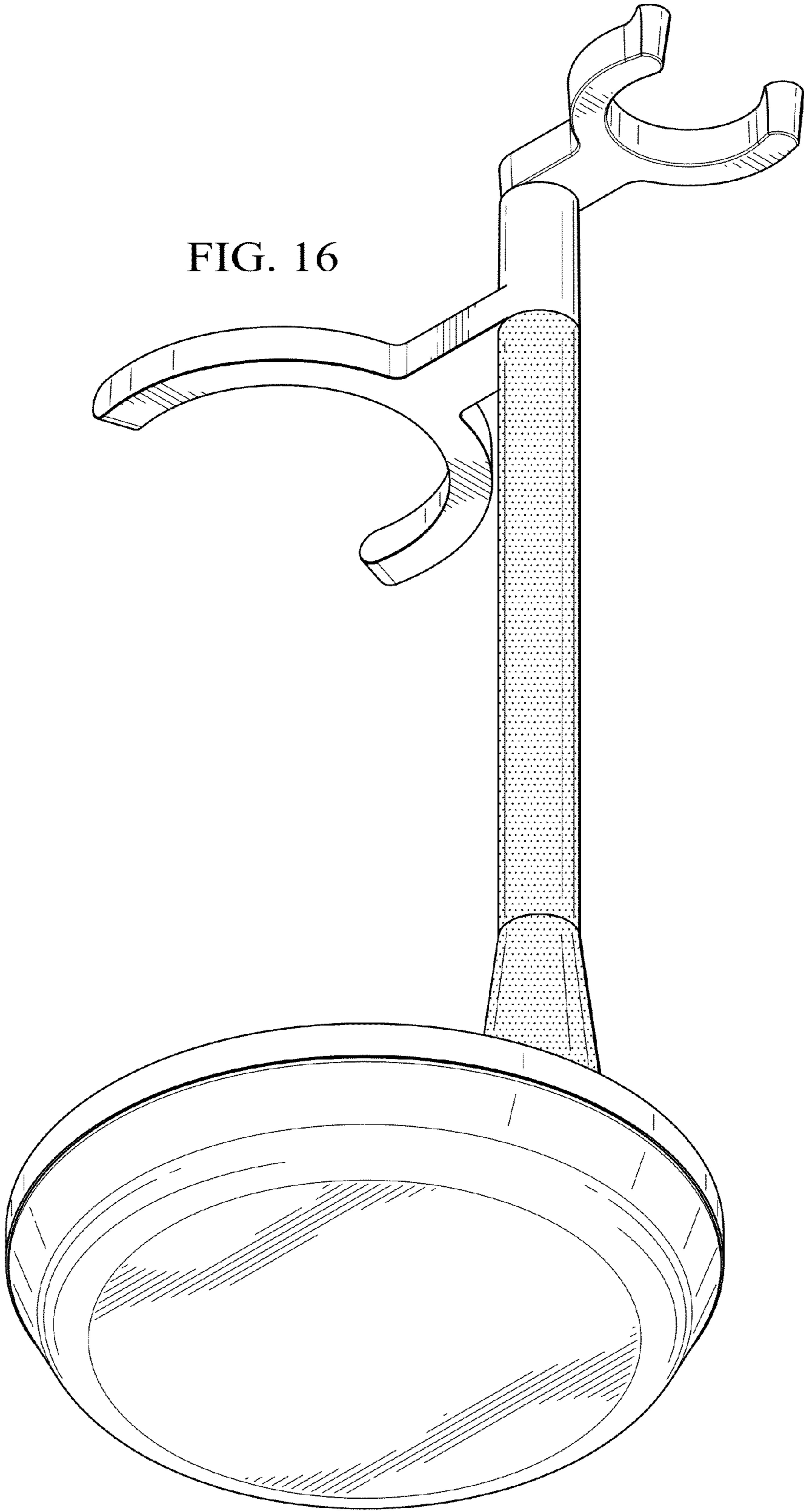

FIG. 16