

US00D699300S

(12) **United States Design Patent**
Lyons

(10) **Patent No.:** **US D699,300 S**

(45) **Date of Patent:** **** Feb. 11, 2014**

(54) **WALL ORGANIZER**

(75) Inventor: **Kurt William Lyons**, Rochester, NY
(US)

(73) Assignee: **Quorum Group, LLC**, Medina, NY
(US)

(**) Term: **14 Years**

(21) Appl. No.: **29/423,299**

(22) Filed: **May 30, 2012**

(51) **LOC (10) Cl.** **19-02**

(52) **U.S. Cl.**

USPC **D19/90**

(58) **Field of Classification Search**

USPC D3/273, 294, 304, 314; D6/310, 676.3,
D6/678.3, 683.1, 700; D9/432;
D19/26-31, 75, 77, 78, 81-86, 90, 91;
206/215, 425, 449, 555; 211/10, 11,
211/46, 48, 87.01; 248/447, 454, 460, 461,
248/462, 463

See application file for complete search history.

(56) **References Cited**

U.S. PATENT DOCUMENTS

2,784,847 A * 3/1957 Holroyd 211/55
2,834,149 A * 5/1958 Hunter et al. 248/445
D215,054 S * 8/1969 Swertz D14/254
4,518,140 A * 5/1985 Ferranto 248/456
D306,661 S * 3/1990 Sanford D6/301

5,058,848 A * 10/1991 Ferraro 248/444.1
5,971,343 A * 10/1999 Marlak 248/441.1
D487,289 S * 3/2004 Richter D19/90
7,438,194 B2 * 10/2008 Wang 211/113
8,141,280 B2 * 3/2012 Doss 40/122
2012/0193247 A1 * 8/2012 Fleet 206/215

* cited by examiner

Primary Examiner — Elizabeth Albert

(74) *Attorney, Agent, or Firm* — Workman Nydegger

(57) **CLAIM**

The ornamental design for a wall organizer, as shown and described.

DESCRIPTION

FIG. 1 is a perspective view of a wall organizer showing my new design;
FIG. 2 is a front elevational view thereof;
FIG. 3 is a left elevational view thereof;
FIG. 4 is a right elevational view thereof;
FIG. 5 is a top plan view thereof;
FIG. 6 is a bottom plan view thereof;
FIG. 7 is a perspective view of another embodiment of a wall organizer showing my new design;
FIG. 8 is a front elevational view thereof;
FIG. 9 is a left elevational view thereof;
FIG. 10 is a right elevational view thereof;
FIG. 11 is a top plan view thereof; and,
FIG. 12 is a bottom plan view thereof.
The broken lines are included in the drawings for the purpose of showing features that form no part of the claimed design.

1 Claim, 8 Drawing Sheets

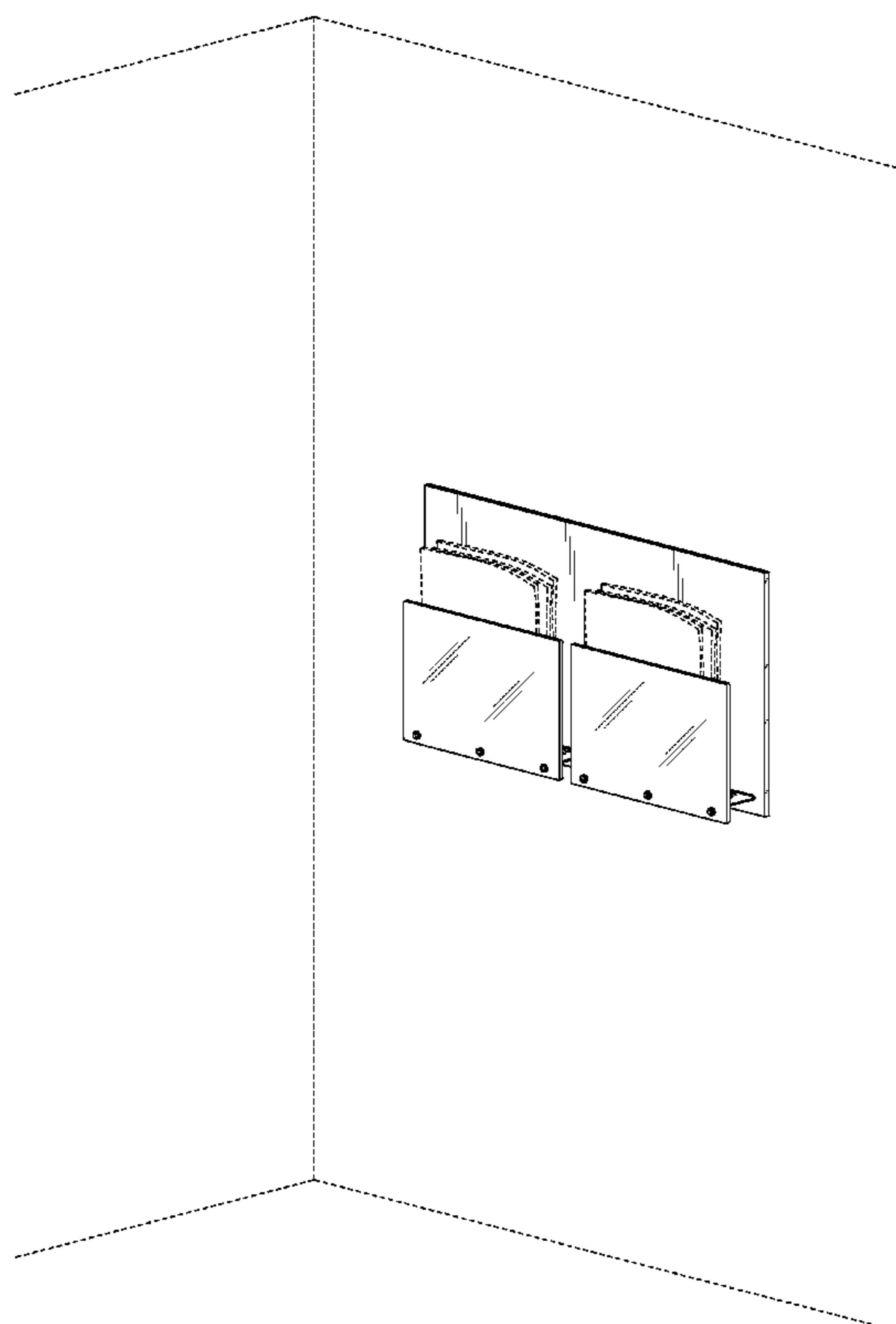

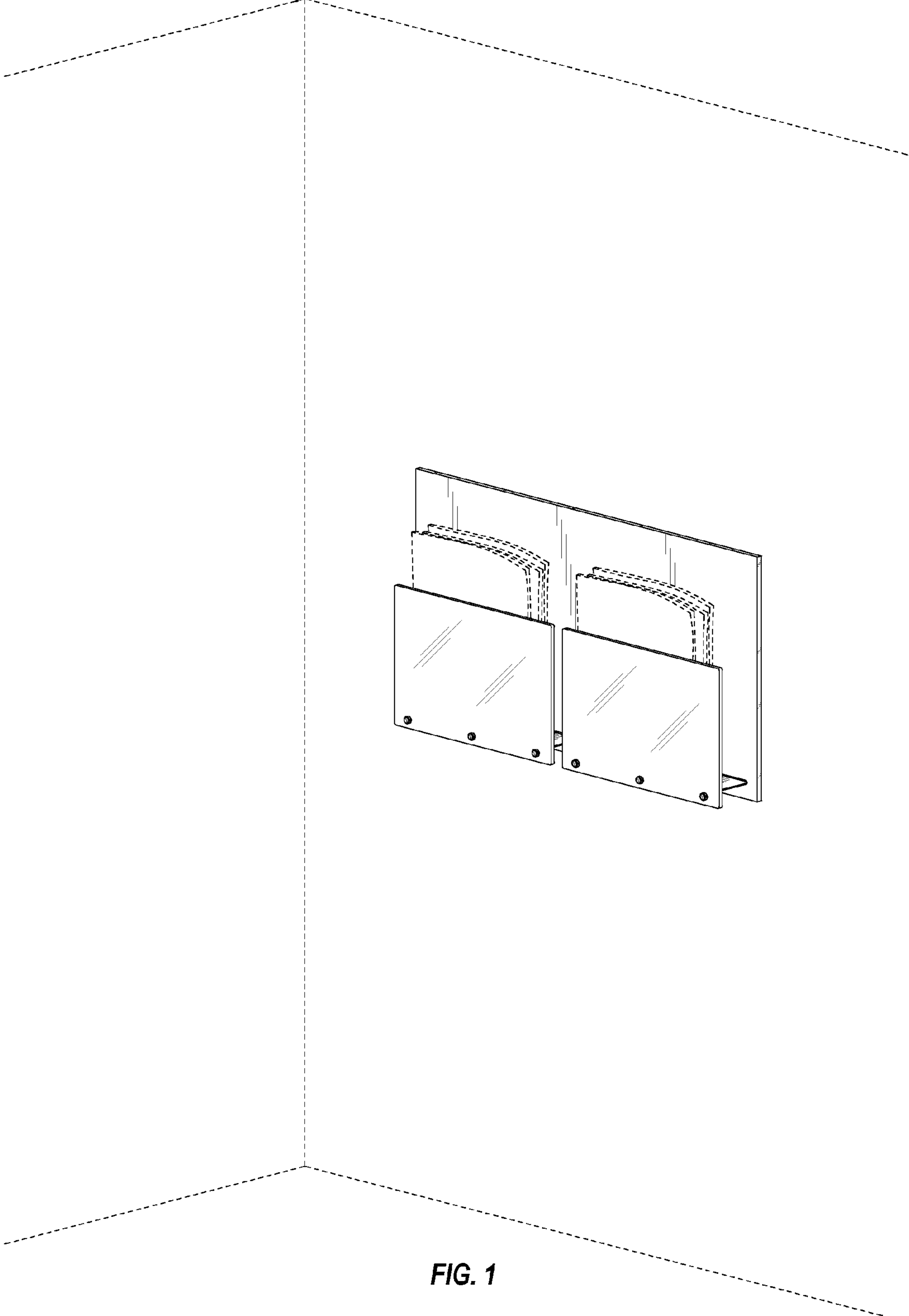

FIG. 1

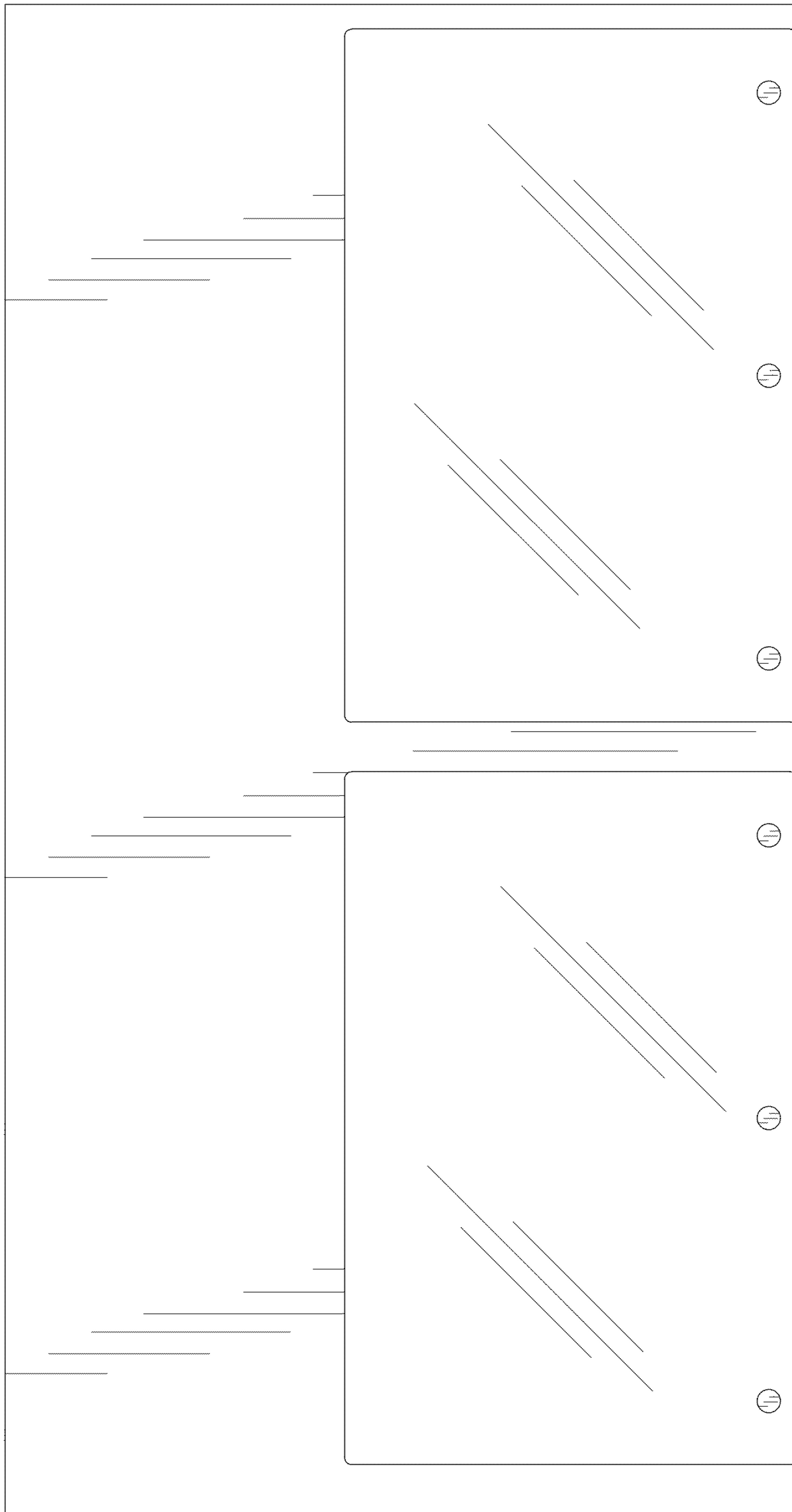

FIG. 2

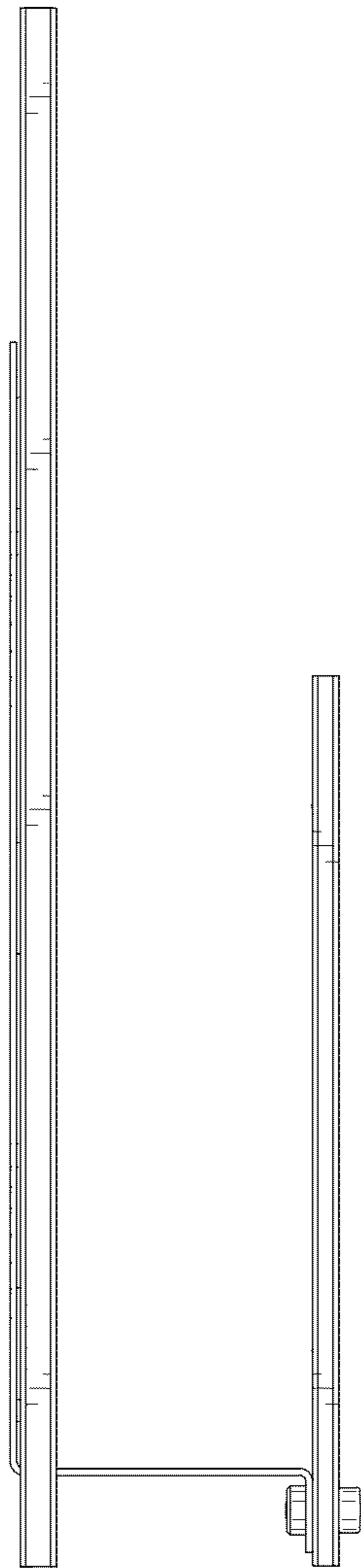

FIG. 3

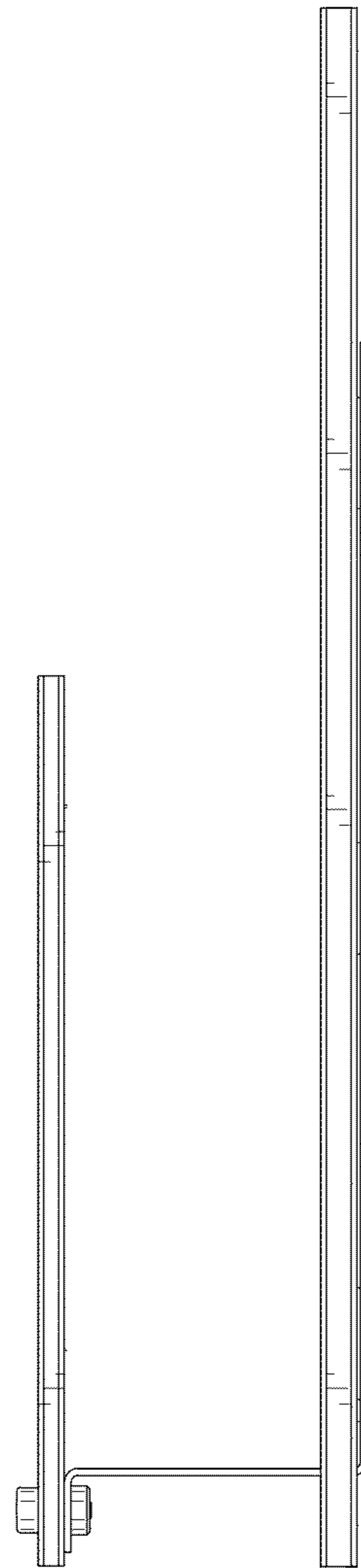

FIG. 4

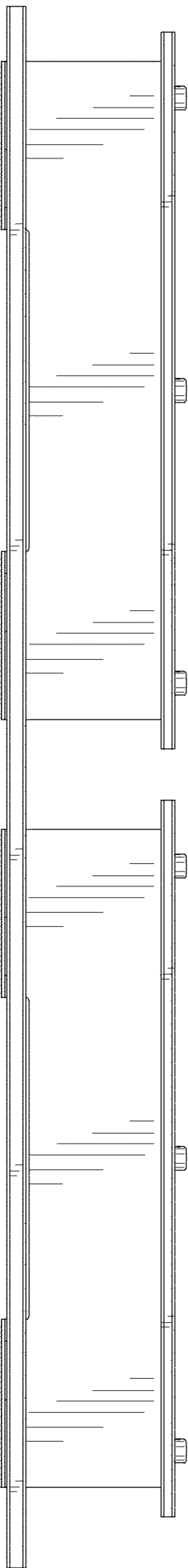

FIG. 5

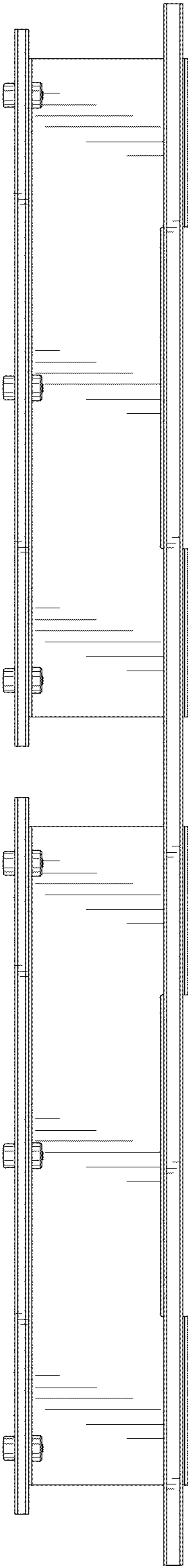

FIG. 6

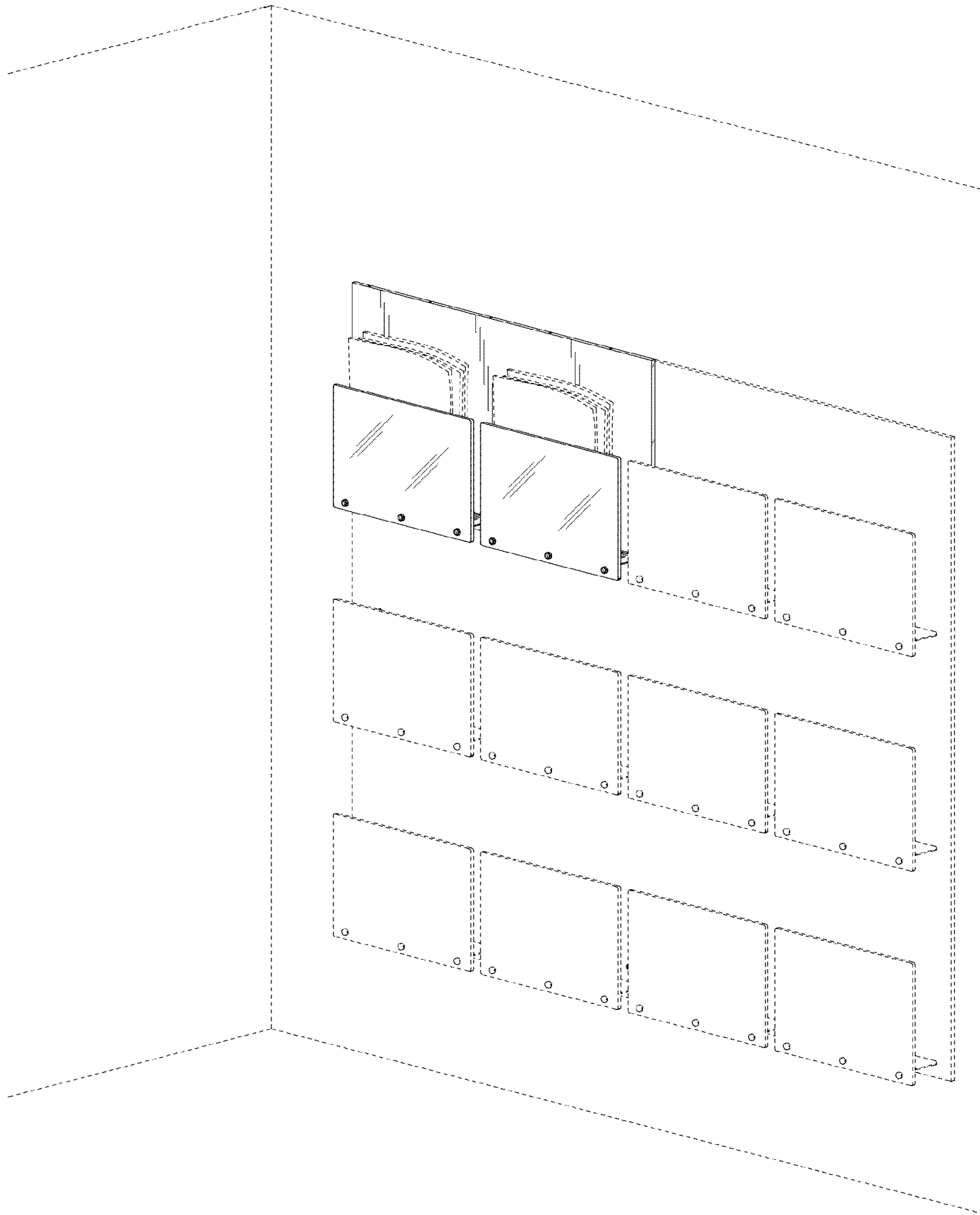

FIG. 7

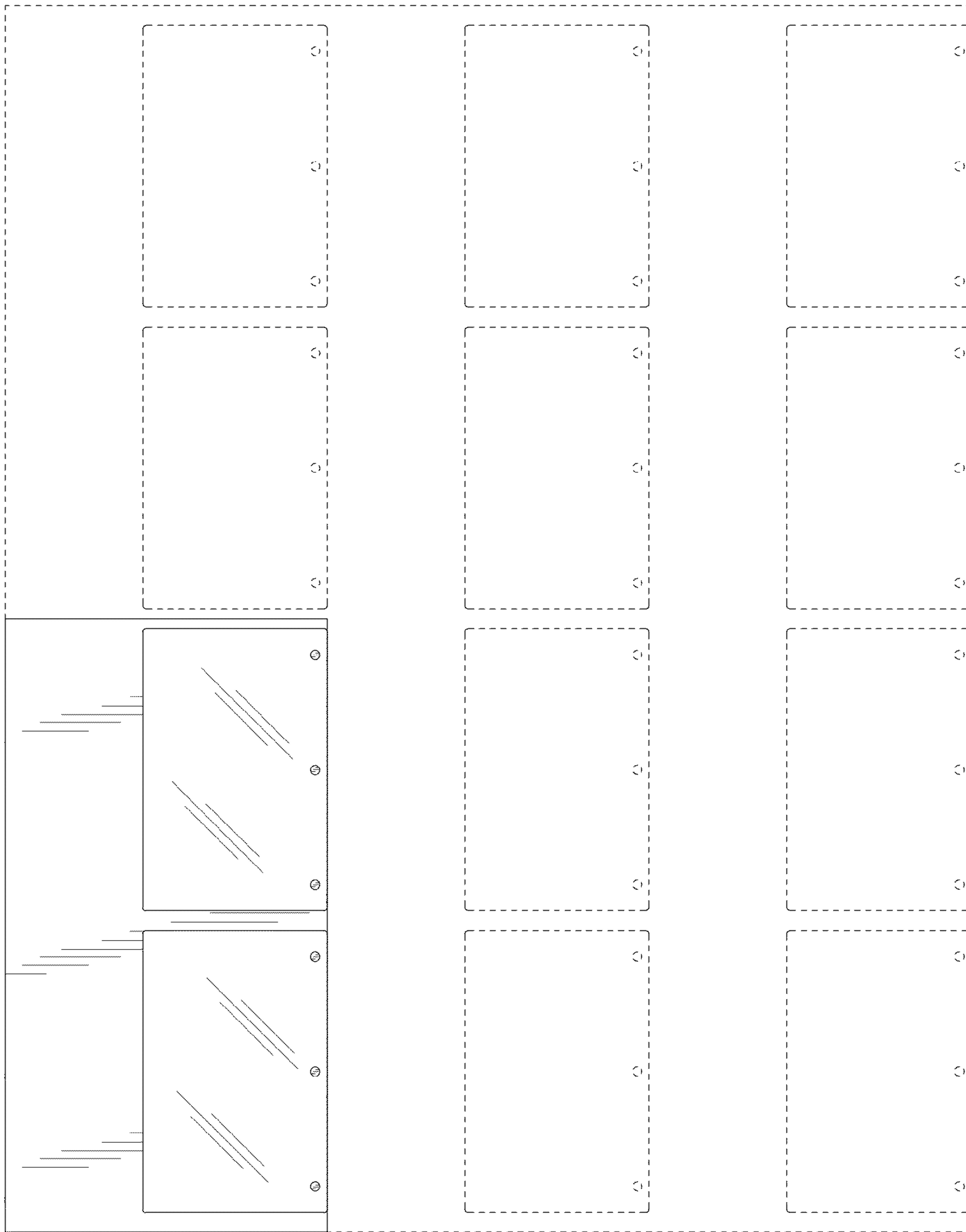

FIG. 8

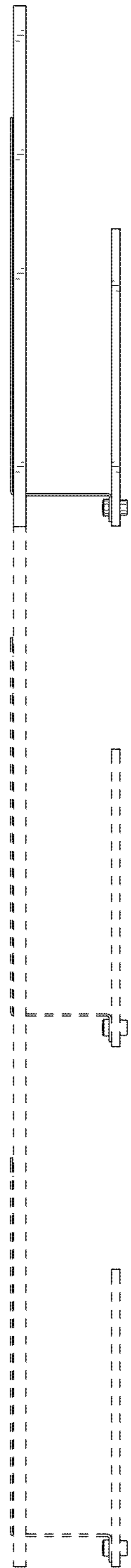

FIG. 9

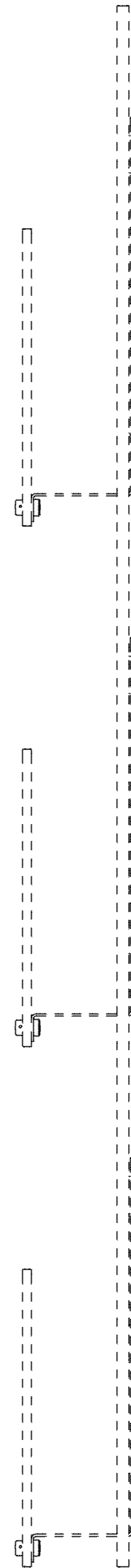

FIG. 10

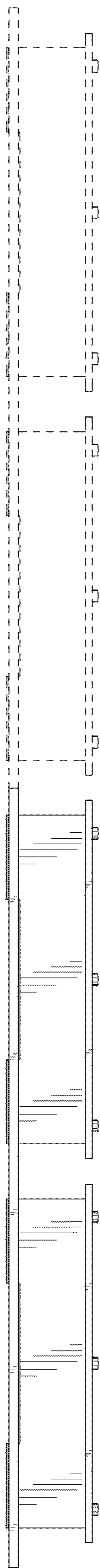

FIG. 11

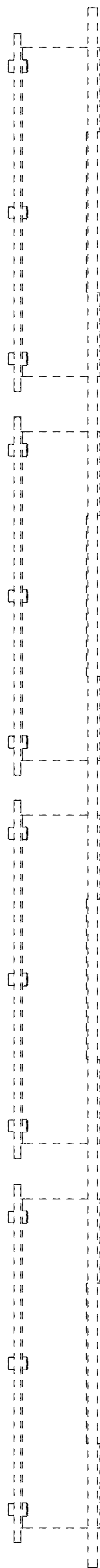

FIG. 12

UNITED STATES PATENT AND TRADEMARK OFFICE
CERTIFICATE OF CORRECTION

PATENT NO. : D699,300 S
APPLICATION NO. : 29/423299
DATED : February 11, 2014
INVENTOR(S) : Lyons

Page 1 of 1

It is certified that error appears in the above-identified patent and that said Letters Patent is hereby corrected as shown below:

Drawings

Delete Figs. 9 and 11 and substitute therefor Figs. 9 and 11 as shown below.

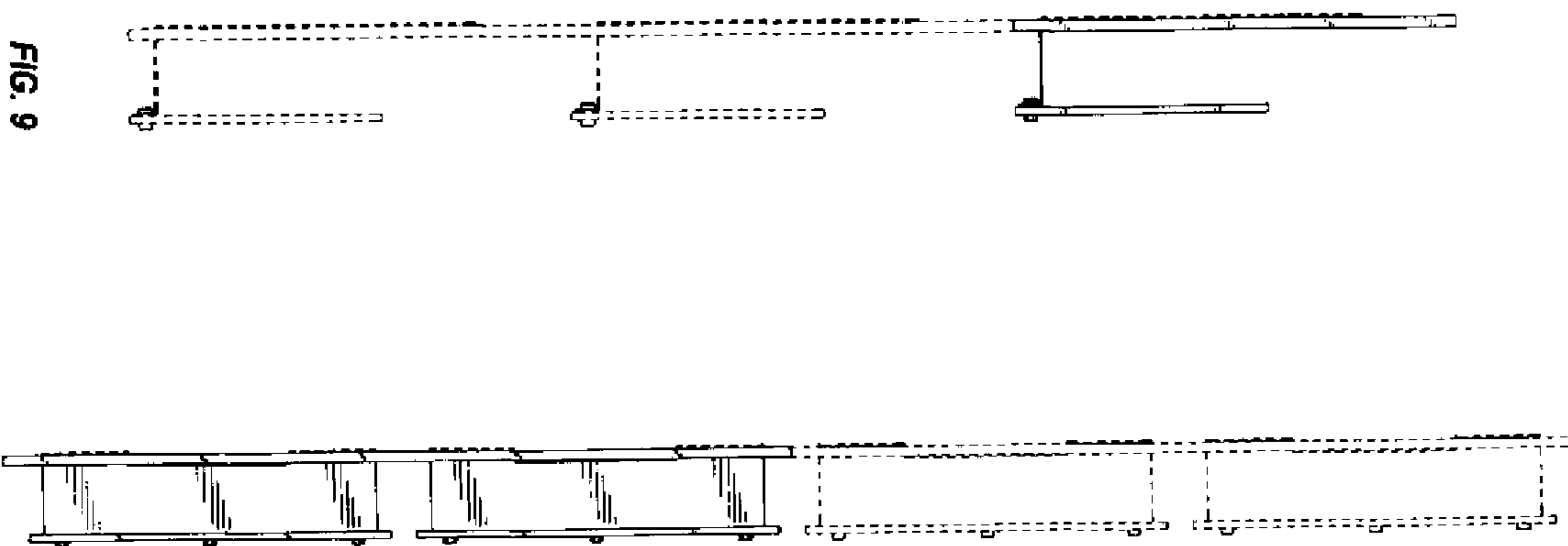

Signed and Sealed this
Twenty-seventh Day of May, 2014

Michelle K. Lee

Michelle K. Lee
Deputy Director of the United States Patent and Trademark Office