



US00D699240S

(12) **United States Design Patent**
Kim et al.

(10) **Patent No.:** **US D699,240 S**

(45) **Date of Patent:** **** Feb. 11, 2014**

(54) **TABLET PC**

(75) Inventors: **Dong-Kyun Kim**, Seoul (KR);
Hyoung-Shin Park, Seoul (KR)

(73) Assignee: **Samsung Electronics Co., Ltd.**,
Suwon-si (KR)

(**) Term: **14 Years**

(21) Appl. No.: **29/426,449**

(22) Filed: **Jul. 5, 2012**

(30) **Foreign Application Priority Data**

Jan. 25, 2012 (KR) 30-2012-0003407

(51) **LOC (10) Cl.** **14-02**

(52) **U.S. Cl.**
USPC **D14/341; D14/345**

(58) **Field of Classification Search**
USPC D14/341-347, 137, 138 AA, 138 R,
D14/138 C, 138 G, 496, 203.1, 203.3, 203.7,
D14/426, 129, 130, 420, 147, 218, 247-248,
D14/389, 388, 315-318; D10/65, 104.1;
D18/6-7; D21/324, 329, 330;
455/556.1, 556.2, 566, 575.1, 90.3;
379/433.04, 433.01, 433.06, 916;
345/173, 901, 905; 361/679.26,
361/679.27, 679.3, 679.55, 679.56,
361/680-686; 248/917-924; 348/373, 376;
D19/60

See application file for complete search history.

(56) **References Cited**

U.S. PATENT DOCUMENTS

D553,750 S * 10/2007 Yamaoka D24/172
D584,304 S * 1/2009 Lin D14/346
D628,575 S * 12/2010 Ko et al. D14/374
D640,691 S * 6/2011 Nieves D14/346
D655,307 S * 3/2012 Maier et al. D14/496

(Continued)

Primary Examiner — Barbara Fox

(74) *Attorney, Agent, or Firm* — NSIP Law

(57) **CLAIM**

The ornamental design for a tablet PC, as shown and described.

DESCRIPTION

FIG. 1 is a front perspective view of a tablet PC showing our new design;

FIG. 2 is a front view of the tablet PC of FIG. 1;

FIG. 3 is a rear view of the tablet PC of FIG. 1;

FIG. 4 is a left-side view of the tablet PC of FIG. 1;

FIG. 5 is a right-side view of the tablet PC of FIG. 1;

FIG. 6 is a top plan view of the tablet PC of FIG. 1;

FIG. 7 is a bottom plan view of the tablet PC of FIG. 1;

FIG. 8 is a rear perspective view of the tablet PC of FIG. 1;

FIG. 9 is a front perspective view of the tablet PC of FIGS. 1-8, shown in an open position;

FIG. 10 is a front view of the tablet PC of FIG. 9;

FIG. 11 is a rear view of the tablet PC of FIG. 9;

FIG. 12 is a left-side view of the tablet PC of FIG. 9;

FIG. 13 is a right-side view of the tablet PC of FIG. 9;

FIG. 14 is a top plan view of the tablet PC of FIG. 9;

FIG. 15 is a bottom plan view of the tablet PC of FIG. 9; and,

FIG. 16 is a rear perspective view of the tablet PC of FIG. 9. The oblique lines shading in the Figures indicate reflective surfaces.

1 Claim, 16 Drawing Sheets

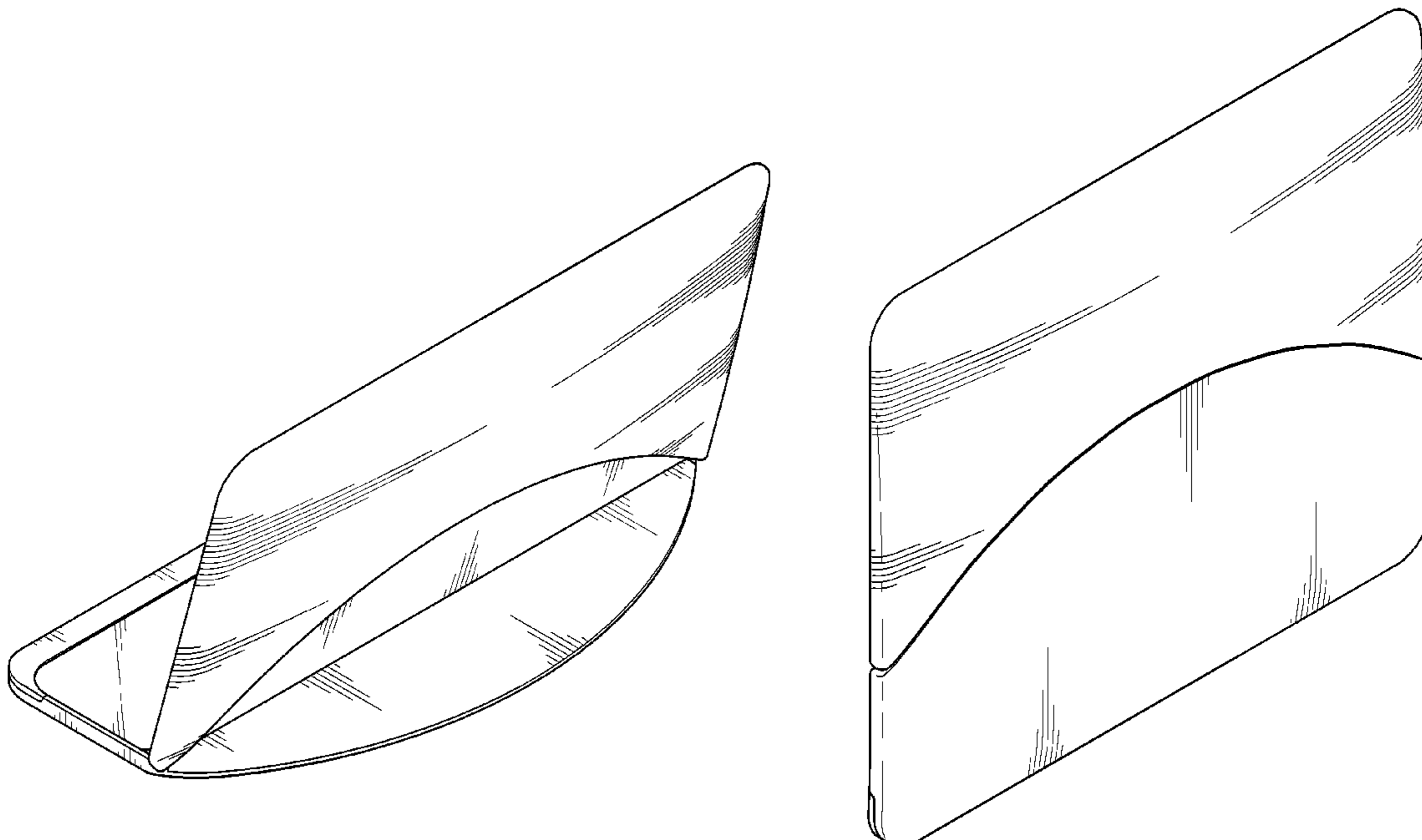

US D699,240 S

Page 2

(56)

References Cited

U.S. PATENT DOCUMENTS

D659,692 S *	5/2012	Jung et al.	D14/341	
D669,467 S *	10/2012	Ballout	D14/336	* cited by examiner
D680,110 S *	4/2013	Rossiter et al.	D14/341	
D681,054 S *	4/2013	Koh et al.	D14/496	
D682,263 S *	5/2013	Kim et al.	D14/341	

FIG.1

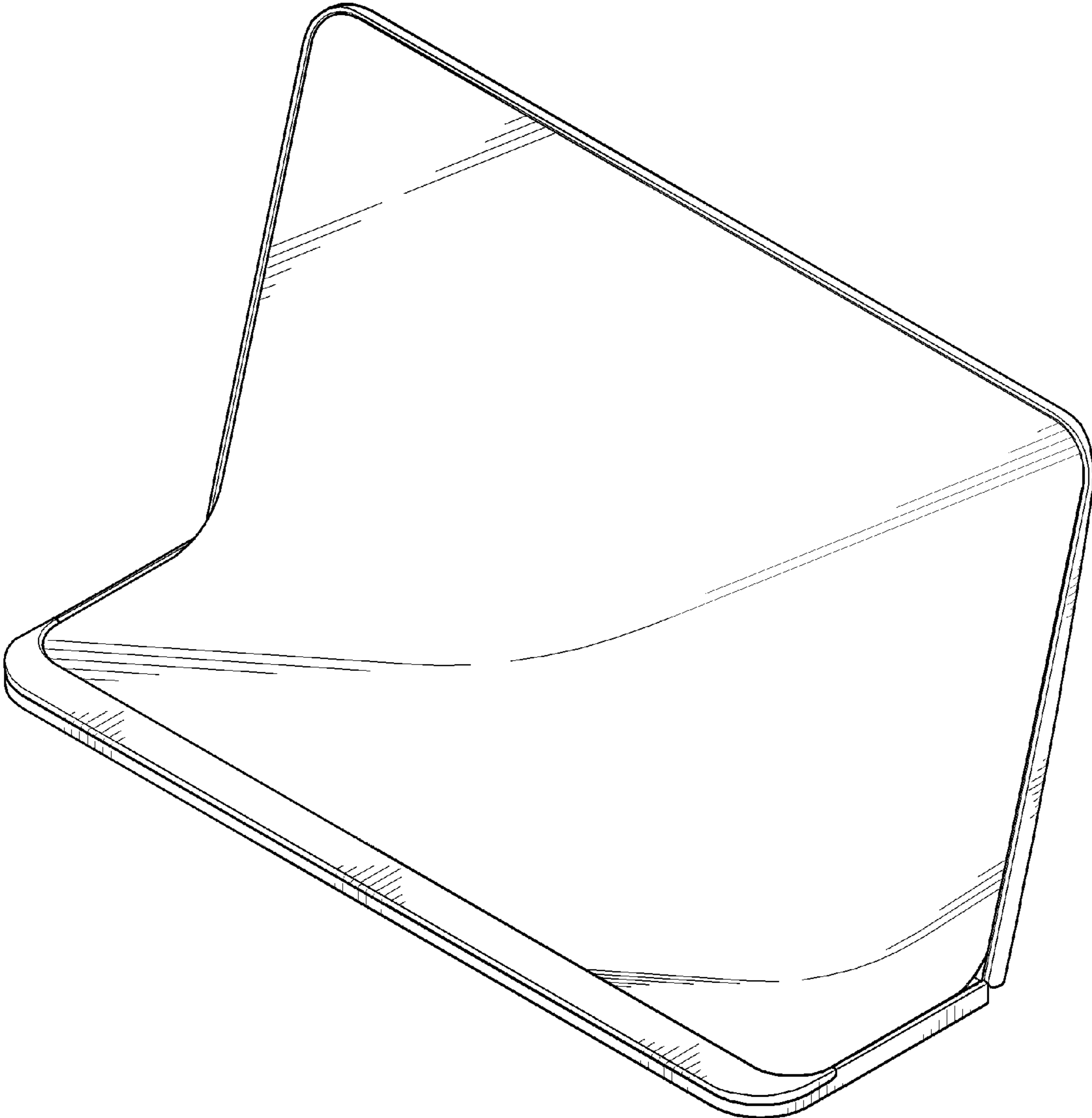

FIG.2

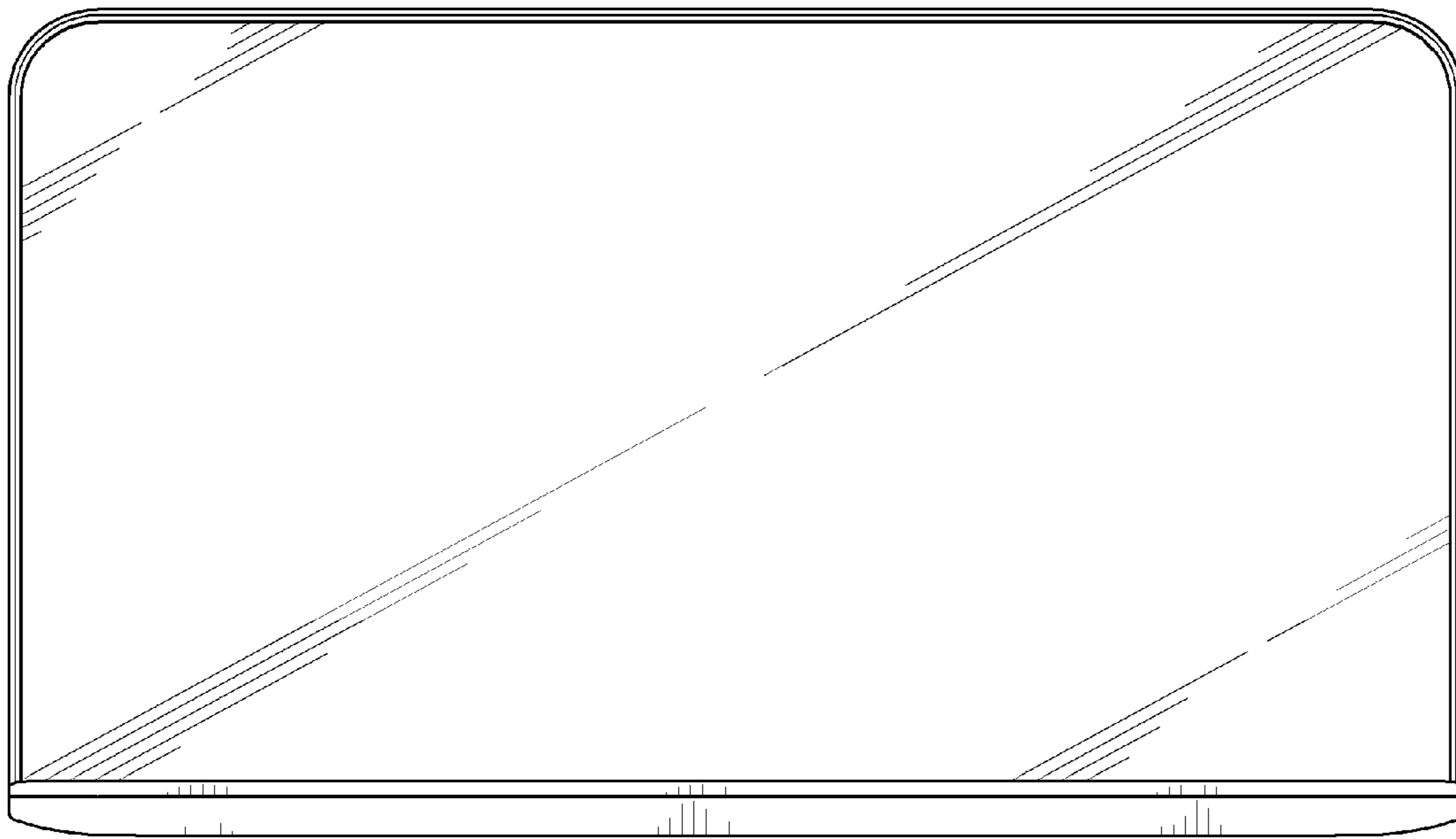

FIG.3

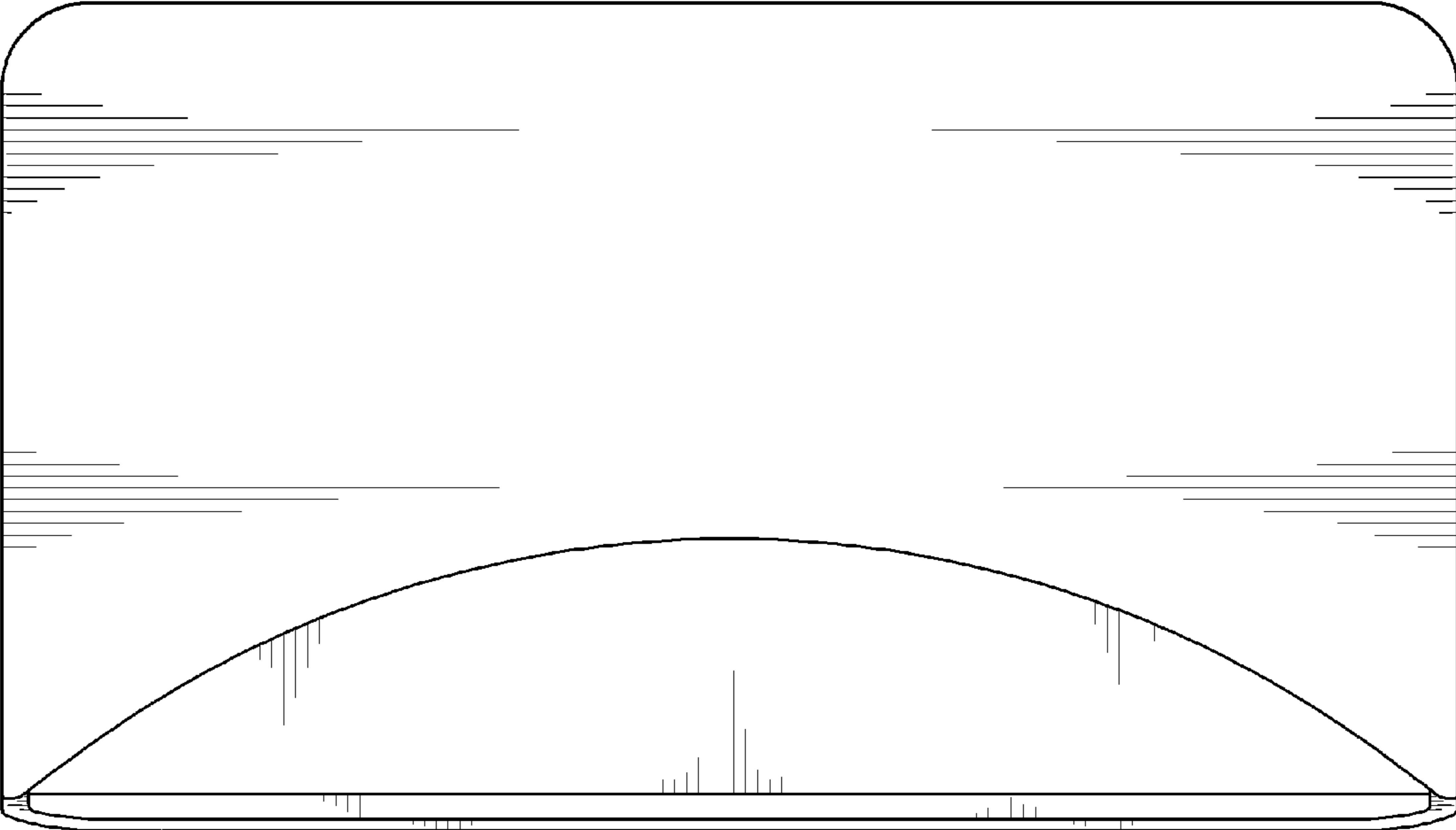

FIG.4

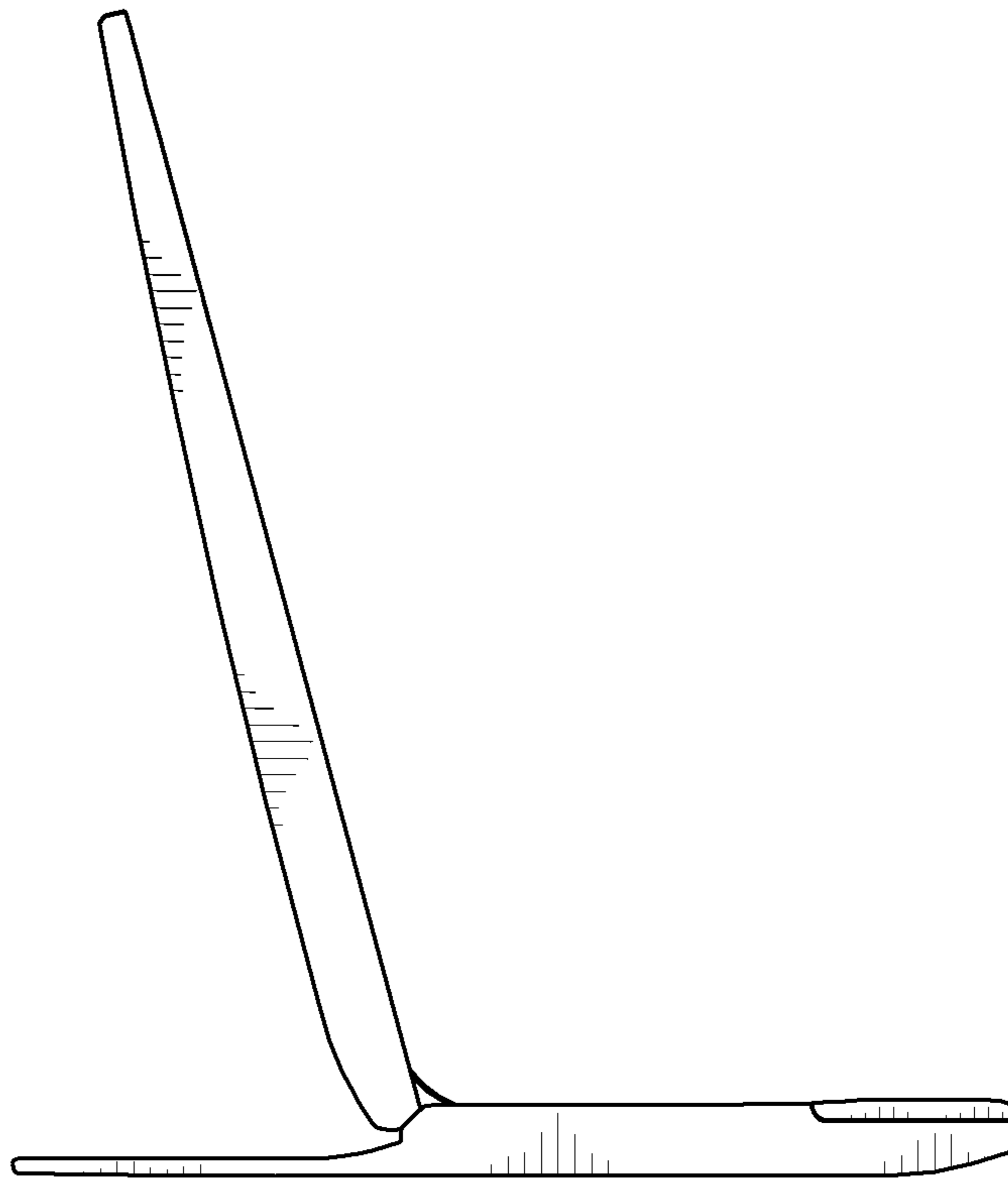

FIG.5

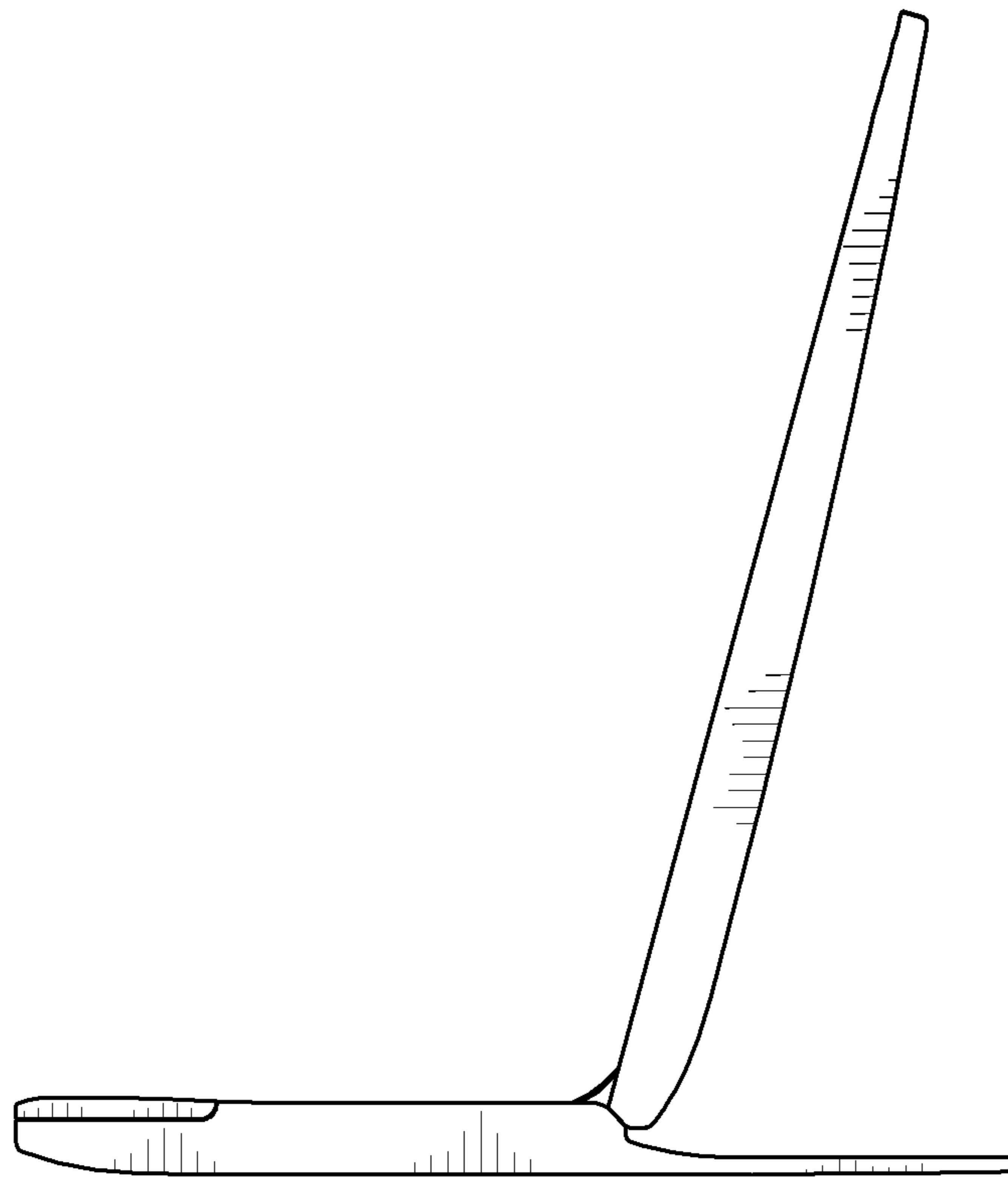

FIG.6

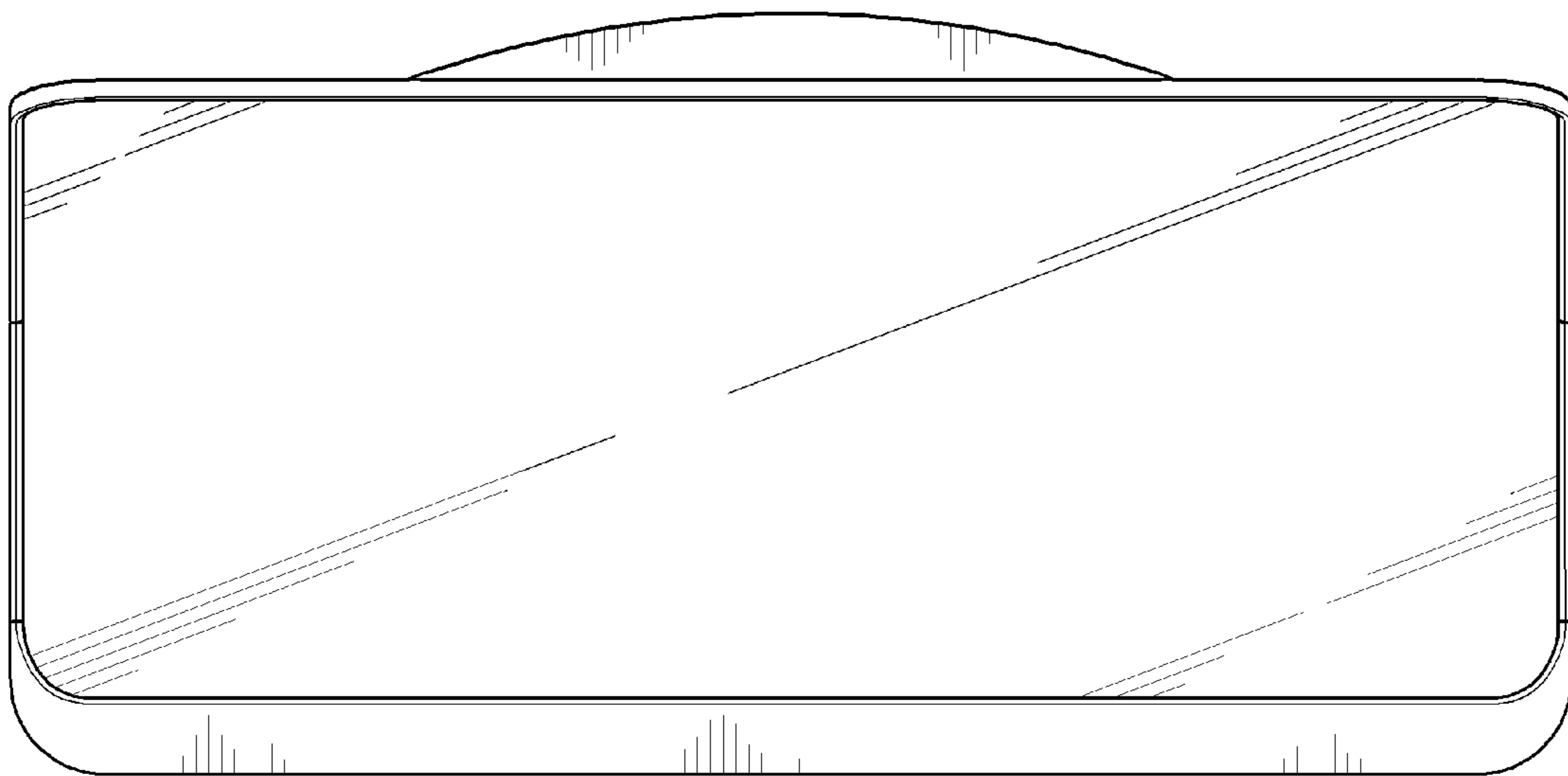

FIG.7

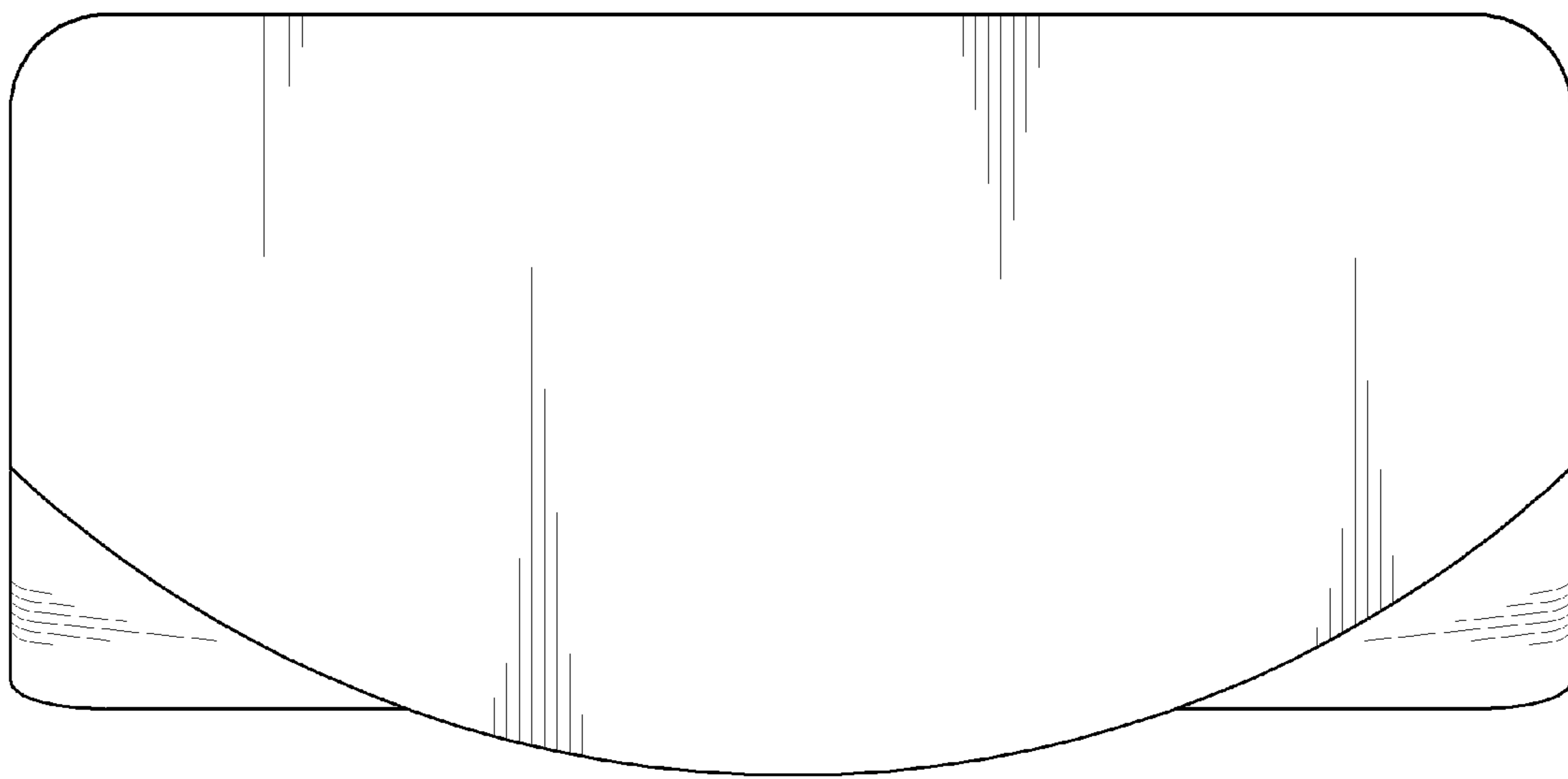

FIG.8

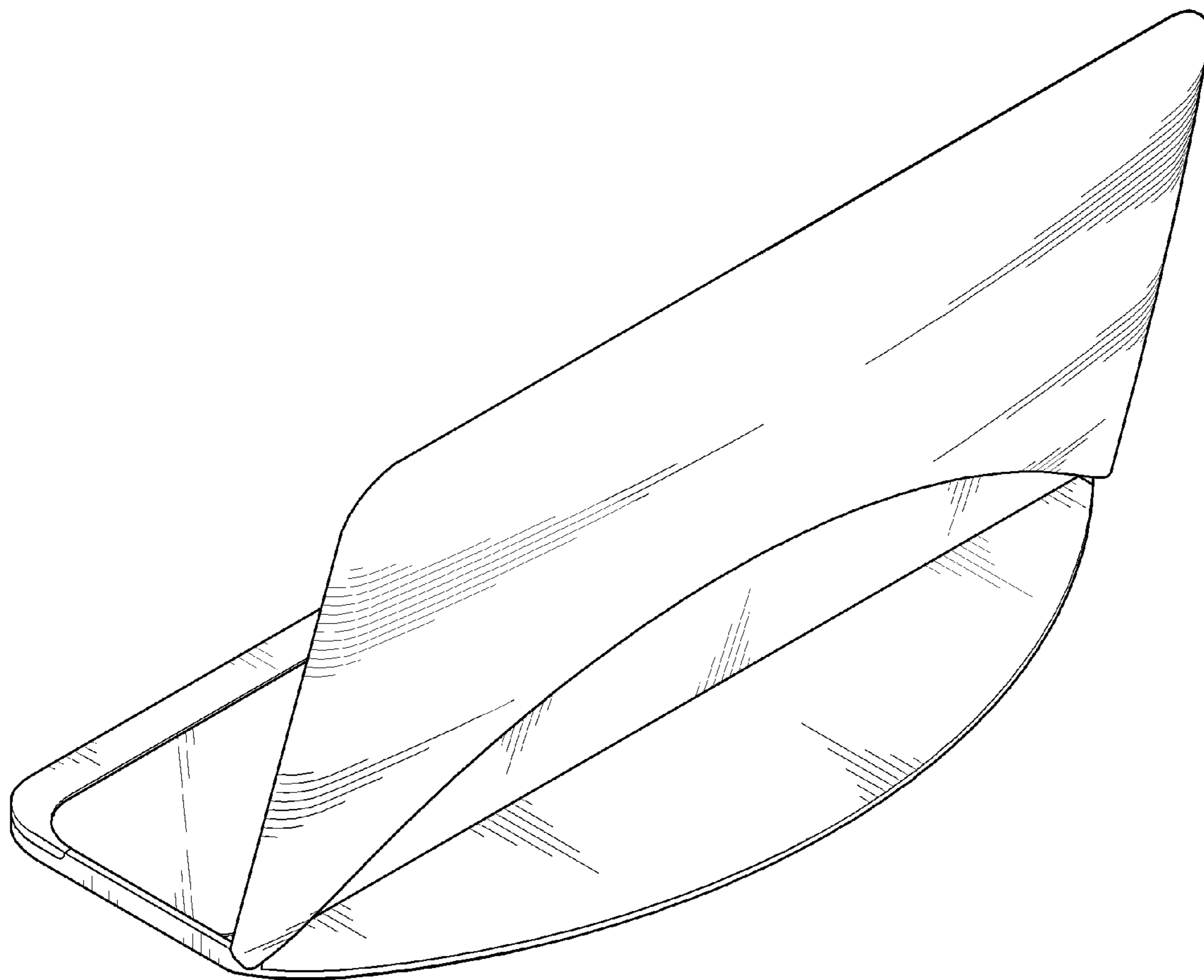

FIG.9

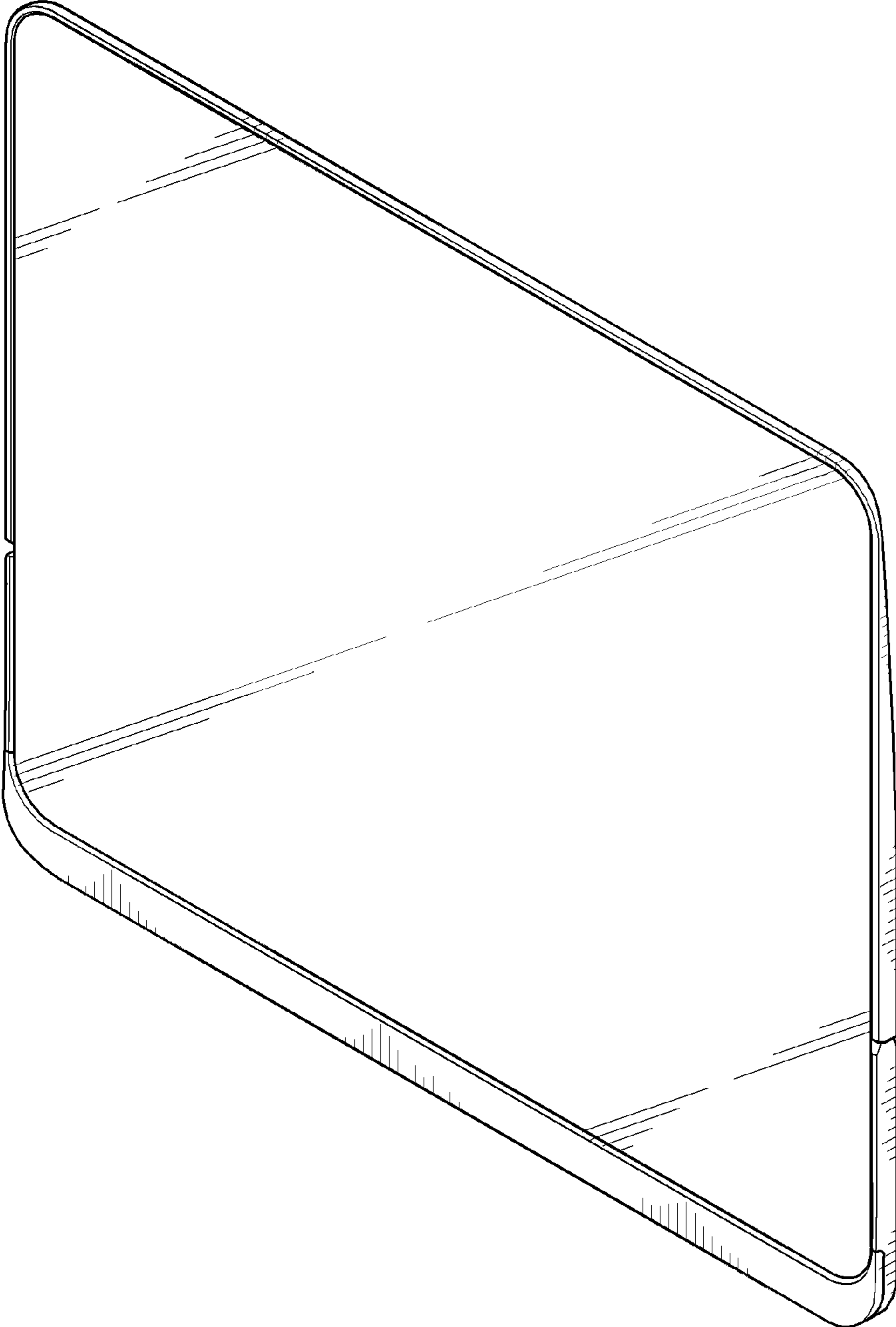

FIG.10

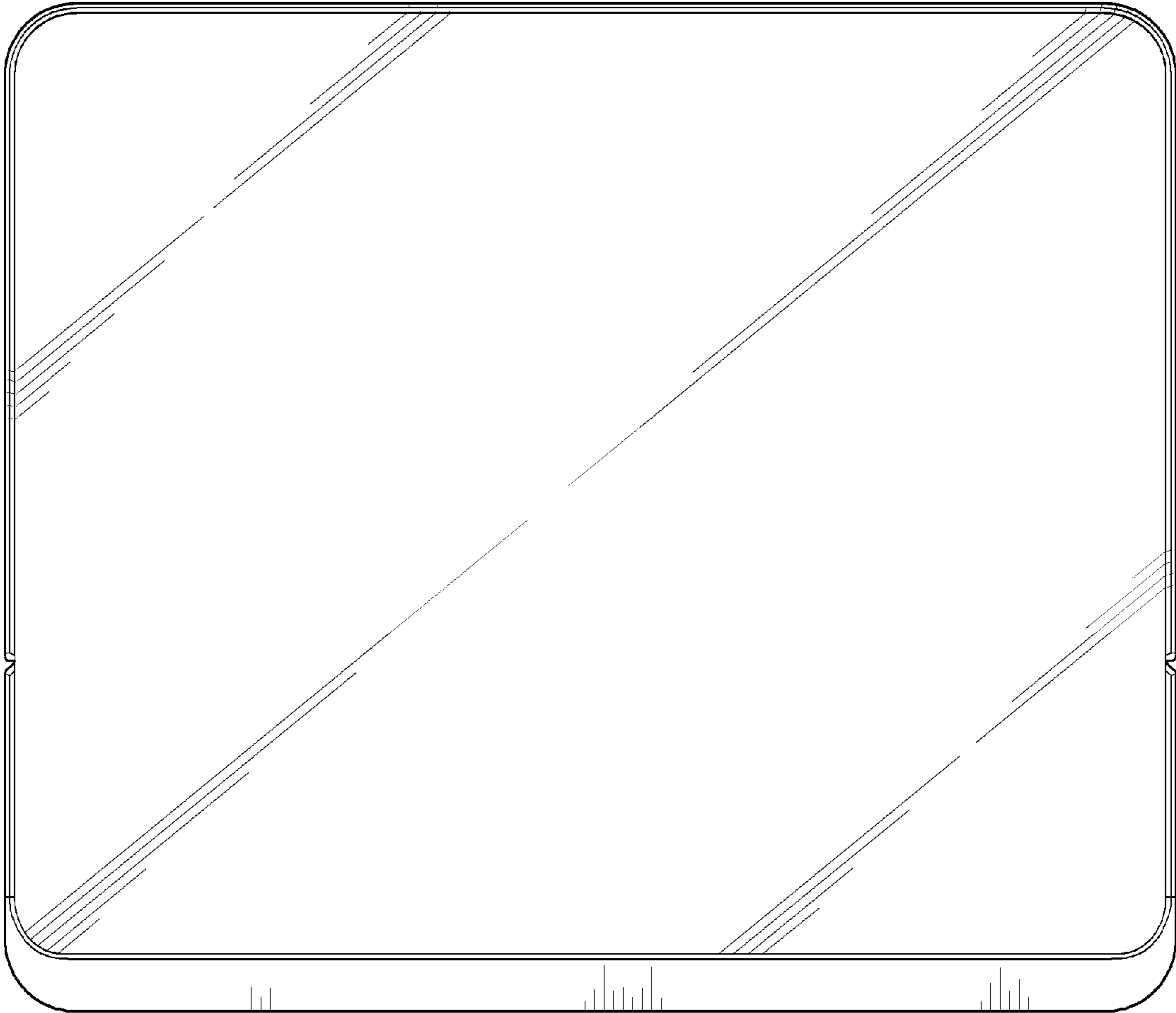

FIG.11

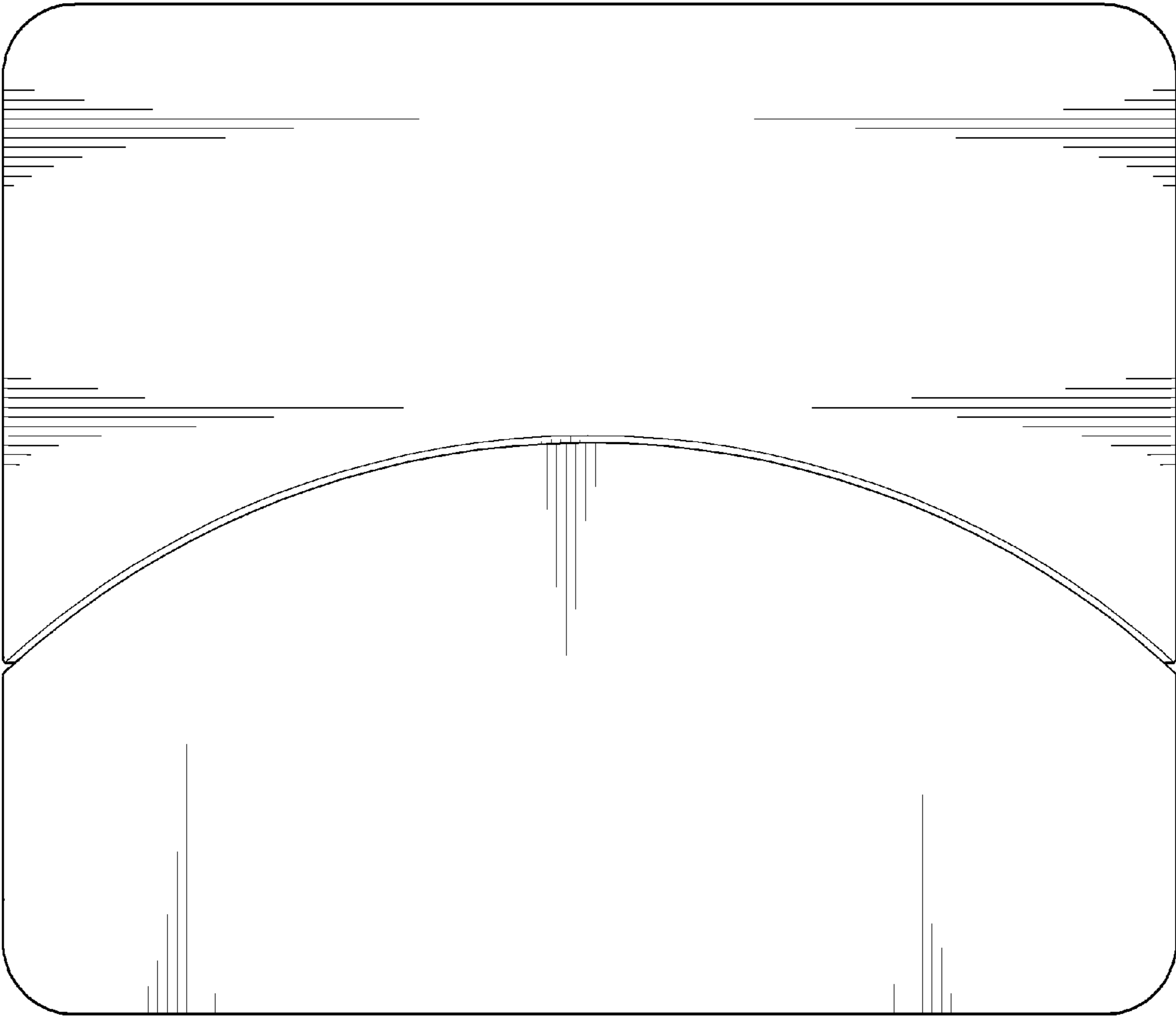

FIG.12



FIG.13

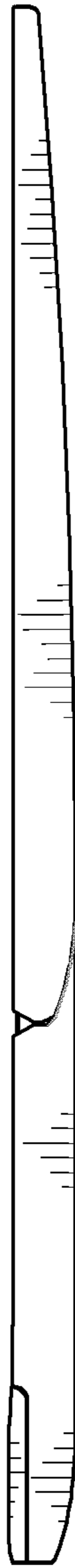

FIG.14



FIG.15

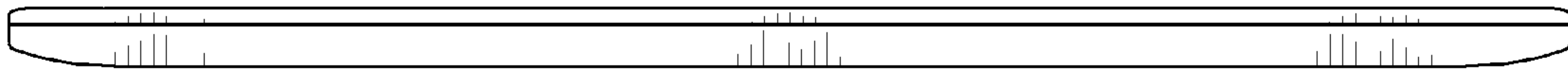

FIG.16

