



US00D699211S

(12) **United States Design Patent**
Koiwa

(10) **Patent No.:** **US D699,211 S**

(45) **Date of Patent:** **** Feb. 11, 2014**

(54) **AUDIO AMPLIFIER FOR AUTOMOBILE**

(56) **References Cited**

(71) Applicant: **JVC Kenwood Corporation**, Kanagawa (JP)

U.S. PATENT DOCUMENTS

(72) Inventor: **Tomotaro Koiwa**, Kanagawa (JP)

D248,951 S *	8/1978	Imazeki	D14/197
D416,558 S *	11/1999	Harrington	D14/188
D508,478 S *	8/2005	Nakajima	D14/188
D549,687 S *	8/2007	Ichikawa	D14/188
D571,352 S *	6/2008	Yamamoto et al.	D14/188
D574,809 S *	8/2008	Yagihashi	D14/188
D580,407 S *	11/2008	Tanaka	D14/188
D655,687 S *	3/2012	Miyawaki	D14/188
D666,166 S *	8/2012	Harada	D14/188

(73) Assignee: **JVC Kenwood Corporation**,
Yokohama-shi, Kanagawa (JP)

(**) Term: **14 Years**

* cited by examiner

(21) Appl. No.: **29/438,920**

Primary Examiner — Keli L Hill

(22) Filed: **Dec. 5, 2012**

(74) *Attorney, Agent, or Firm* — Osha Liang LLP

(30) **Foreign Application Priority Data**

Jun. 5, 2012 (JP) 2012-013278

(51) **LOC (10) CL.** **14-03**

(52) **U.S. Cl.**
USPC **D14/188**

(58) **Field of Classification Search**
USPC D14/162, 167–169, 175, 179, 188,
D14/194–198, 217, 257, 265, 299, 496;
330/1 R, 3, 4, 250; 381/86, 120;
455/344–351

See application file for complete search history.

(57) **CLAIM**

The ornamental design for audio amplifier for automobile, as shown and described.

DESCRIPTION

FIG. 1 is a perspective view of front, right and top of audio amplifier for automobile showing my new design;

FIG. 2 is a front view thereof;

FIG. 3 is a rear view thereof;

FIG. 4 is a left side view thereof;

FIG. 5 is a right side view thereof;

FIG. 6 is a top view thereof; and,

FIG. 7 is a bottom view thereof.

The broken lines showing of audio amplifier for automobile is included for the purpose of illustrating portions of audio amplifier for automobile and forms no part of the claimed design.

1 Claim, 5 Drawing Sheets

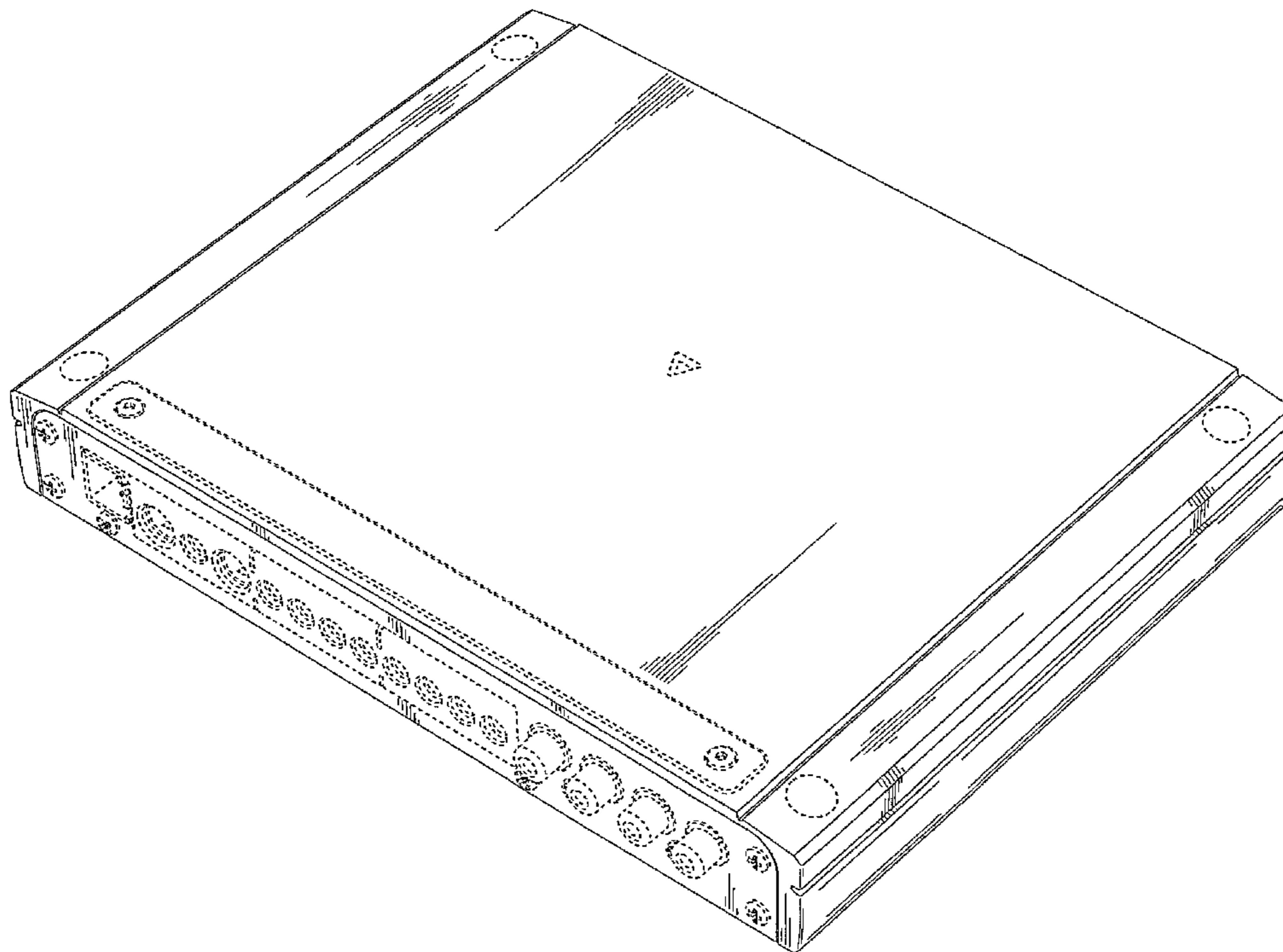

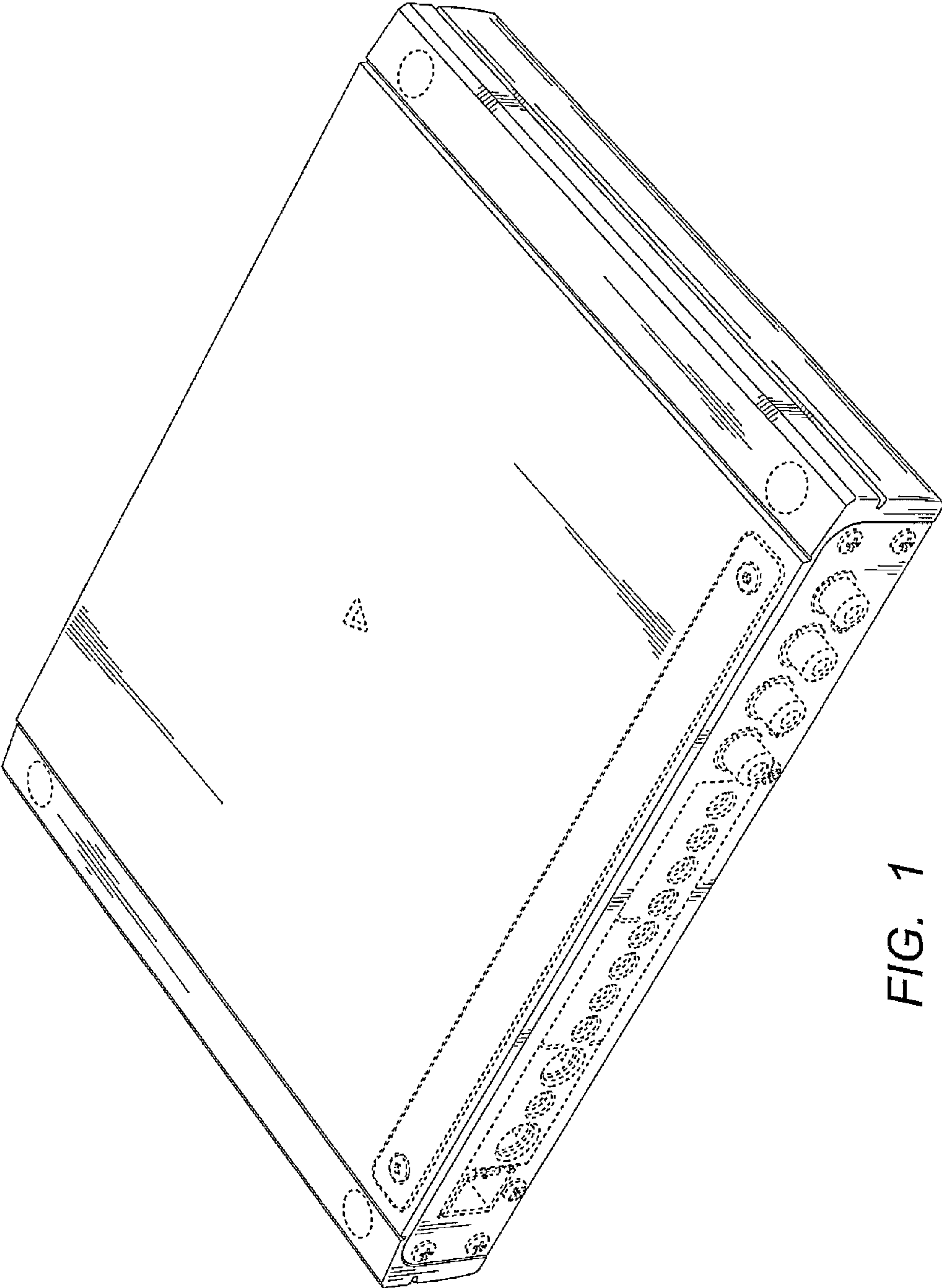

FIG. 1

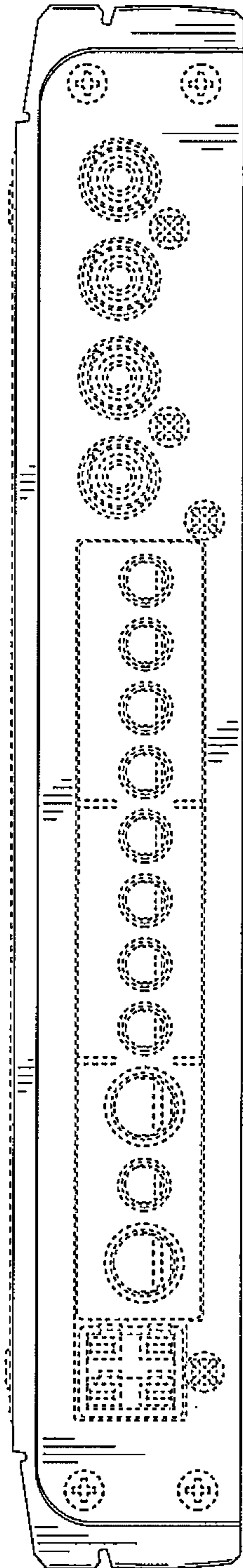

FIG. 2

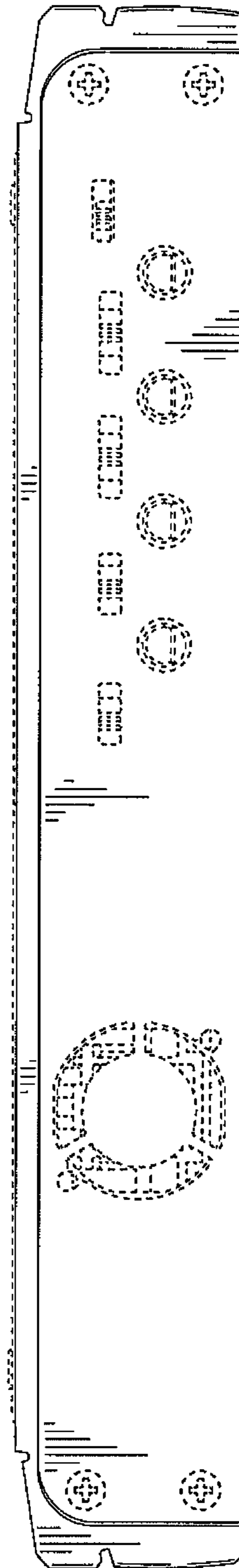

FIG. 3

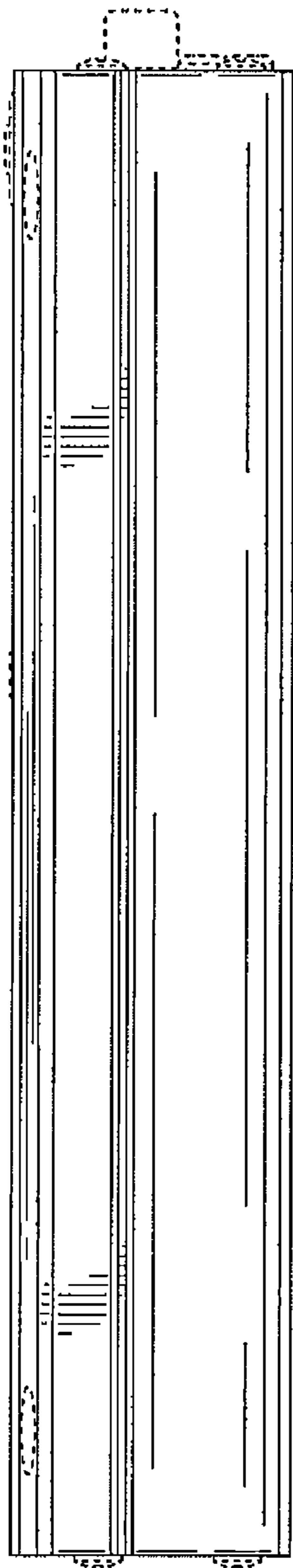

FIG. 4

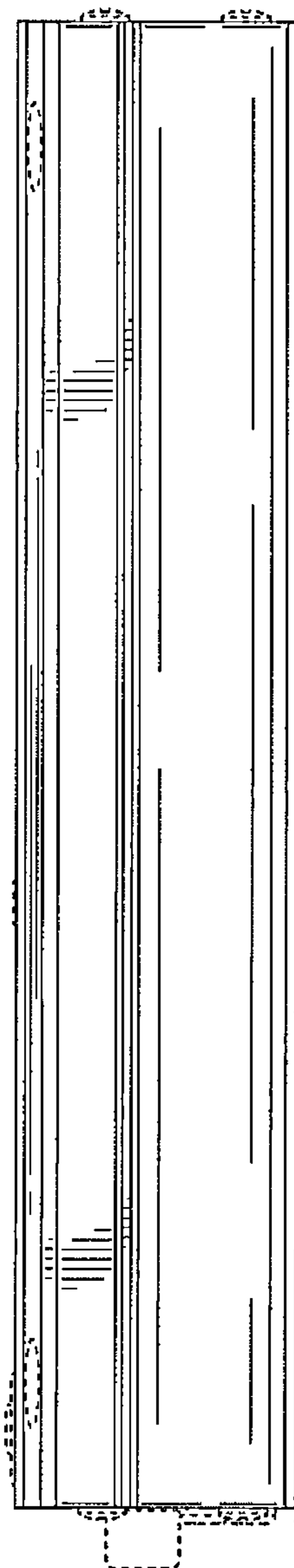

FIG. 5

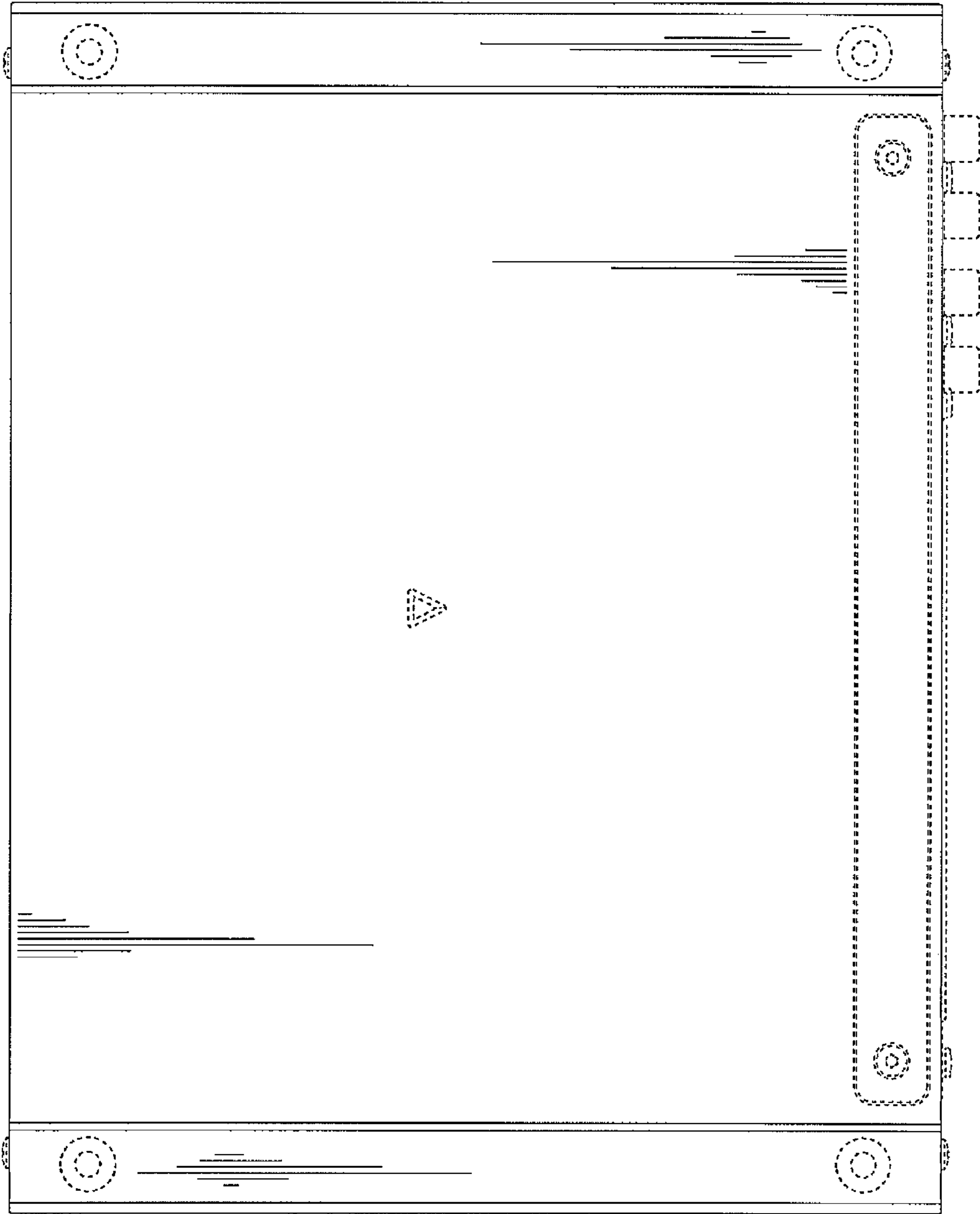

FIG. 6

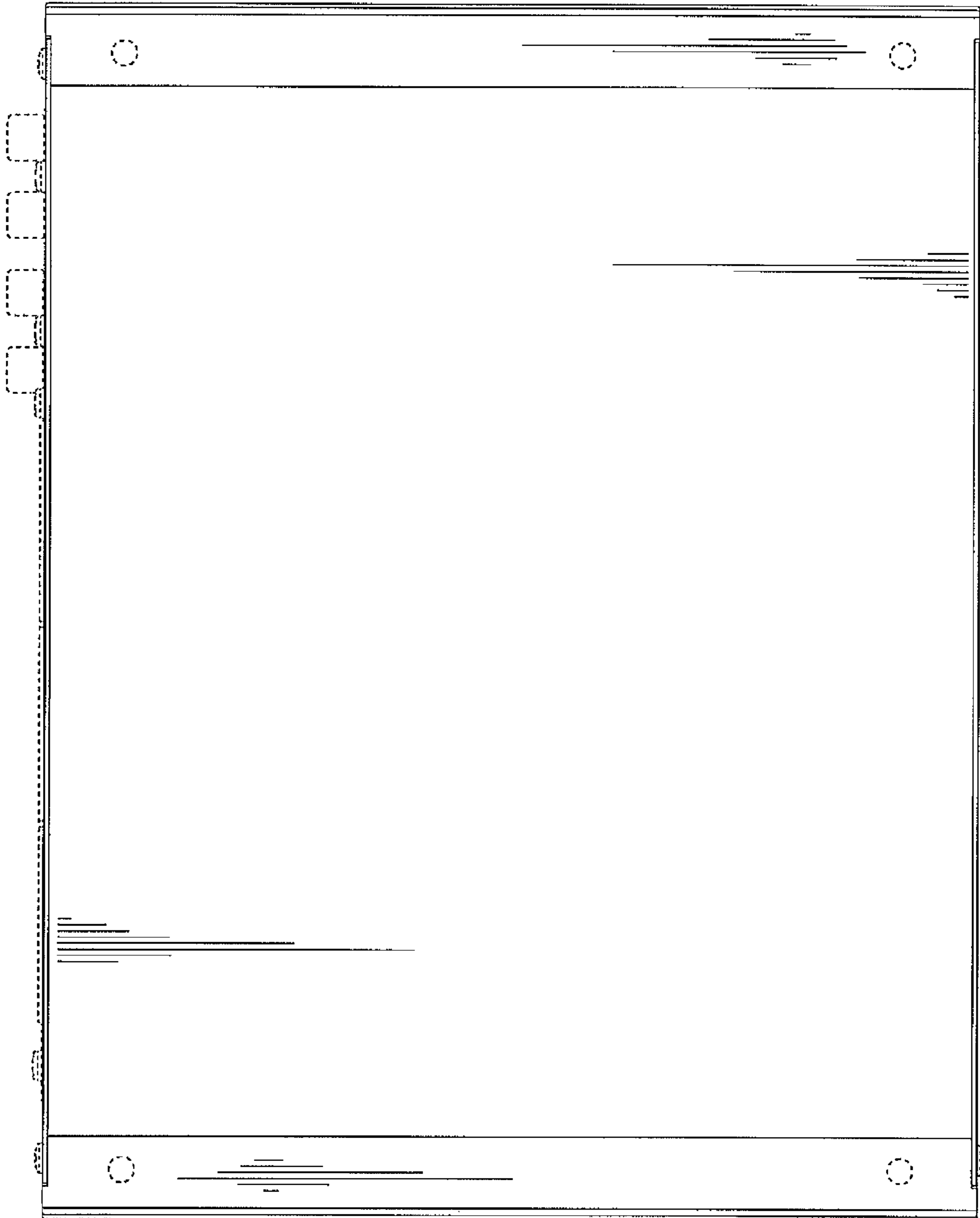

FIG. 7