



US00D699164S

(12) **United States Design Patent**
Watabe

(10) **Patent No.:** **US D699,164 S**
(45) **Date of Patent:** **** Feb. 11, 2014**

- (54) **BUMPER FOR AN AUTOMOBILE**
- (75) Inventor: **Takuya Watabe**, Toyota (JP)
- (73) Assignee: **Toyota Jidosha Kabushiki Kaisha** (JP)
- (**) Term: **14 Years**
- (21) Appl. No.: **29/429,223**
- (22) Filed: **Aug. 8, 2012**
- (51) **LOC (10) Cl.** **12-16**
- (52) **U.S. Cl.**
USPC **D12/169**
- (58) **Field of Classification Search**
USPC D12/169, 196, 171, 216, 163, 86,
D12/90-92; 293/102, 113, 115, 117, 120;
296/180.1, 180.2

See application file for complete search history.

- D683,283 S * 5/2013 Choi D12/169
- D684,905 S * 6/2013 Tase et al. D12/169
- D688,990 S * 9/2013 Song et al. D12/169

OTHER PUBLICATIONS

Toyota, Toyota Highlander 2011, Netcarshow.com, http://www.netcarshow.com/toyota/2011-highlander/800x600/wallpaper_11.htm, available at least as early as Mar. 21, 2011.
Hyundai, Hyundai ix35 2011, Netcarshow.com, http://www.netcarshow.com/hyundai/2011-ix35/1600x1200/wallpaper_3b.htm, available at least as early as Mar. 21, 2011.

* cited by examiner

Primary Examiner — Melody Brown
(74) *Attorney, Agent, or Firm* — SAIDMAN DesignLaw Group

(57) **CLAIM**
The ornamental design for a bumper for an automobile, as shown and described.

DESCRIPTION

FIG. 1 is a perspective view of a bumper for an automobile showing our new design;
FIG. 2 is a front view thereof;
FIG. 3 is a rear view thereof;
FIG. 4 is a top view thereof;
FIG. 5 is a bottom view thereof;
FIG. 6 is a right side view thereof; and,
FIG. 7 is a left side view thereof.

1 Claim, 4 Drawing Sheets

- (56) **References Cited**
U.S. PATENT DOCUMENTS

D631,407 S * 1/2011 Kuze D12/169
D671,054 S * 11/2012 Yamada et al. D12/169
D671,055 S * 11/2012 Nakamura et al. D12/169
D682,167 S * 5/2013 Minami D12/169
D683,282 S * 5/2013 Fuchigami D12/169

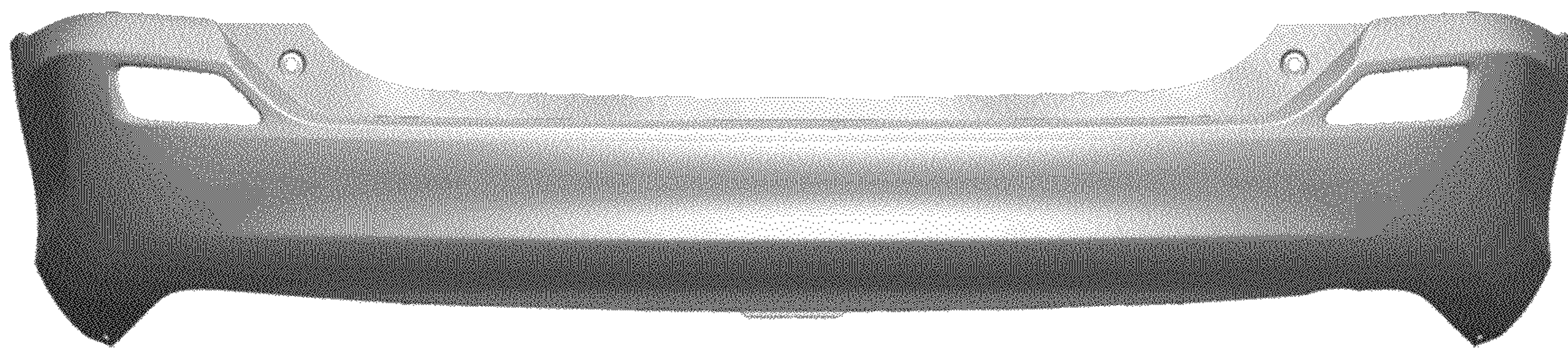



FIG. 1

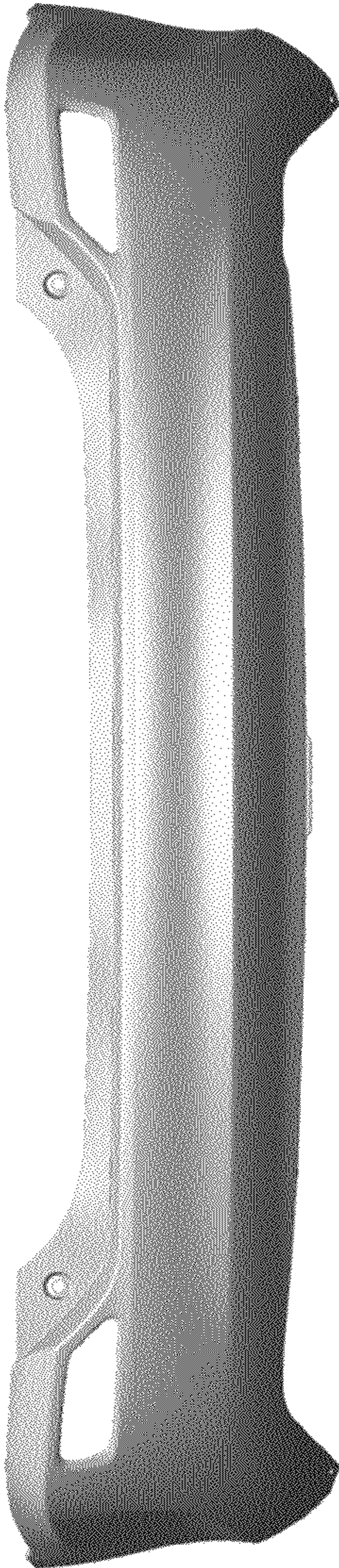

FIG. 2

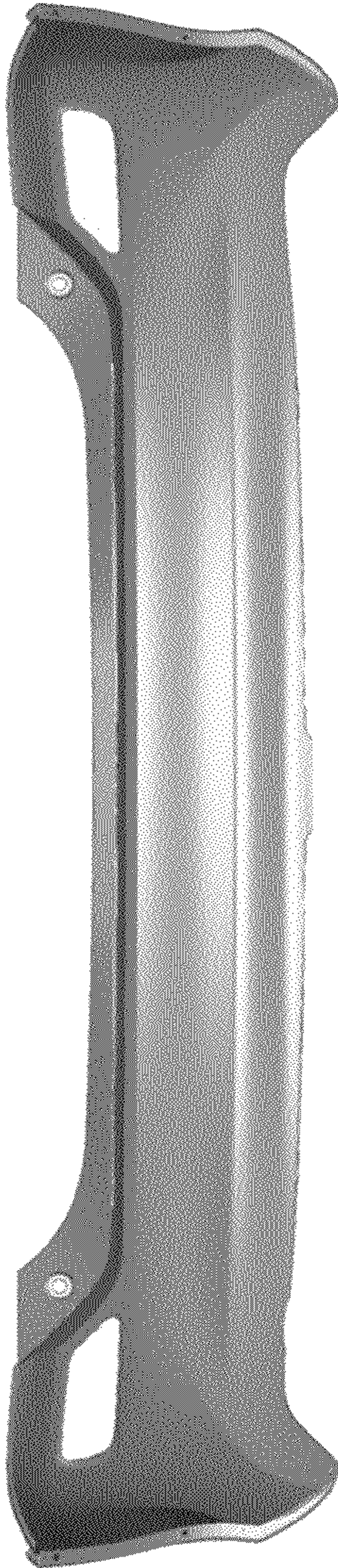

FIG. 3

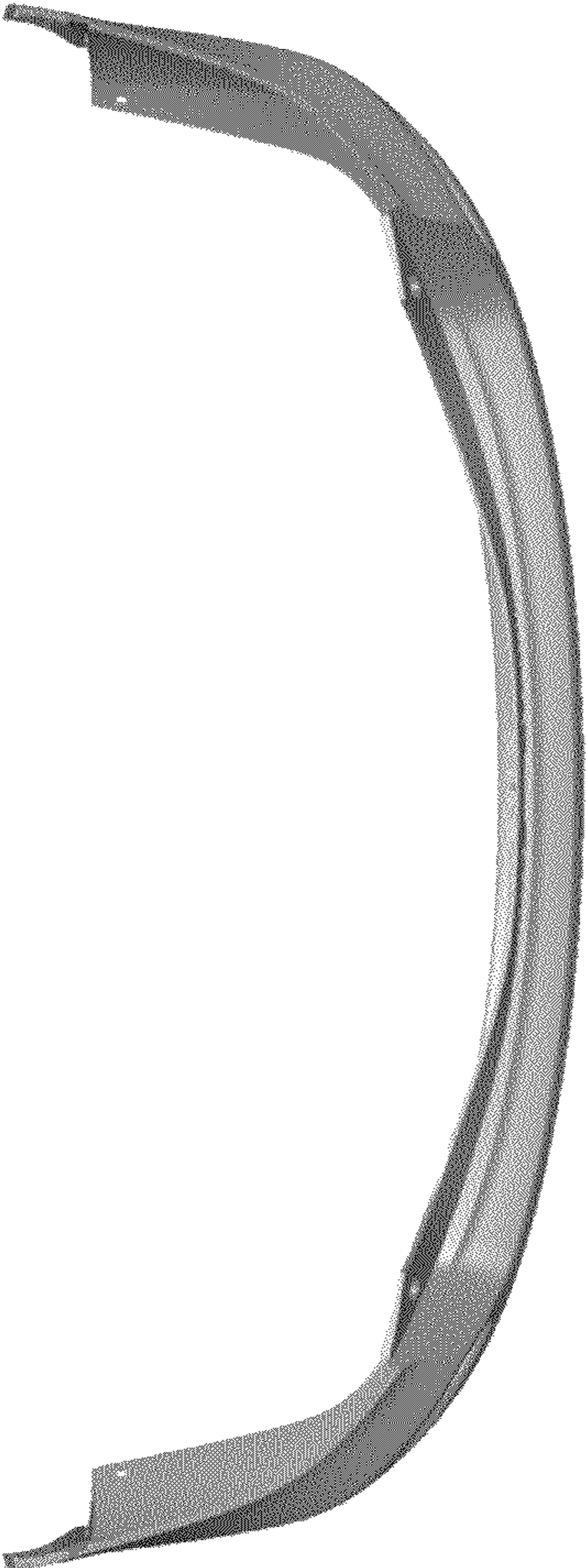

FIG. 4

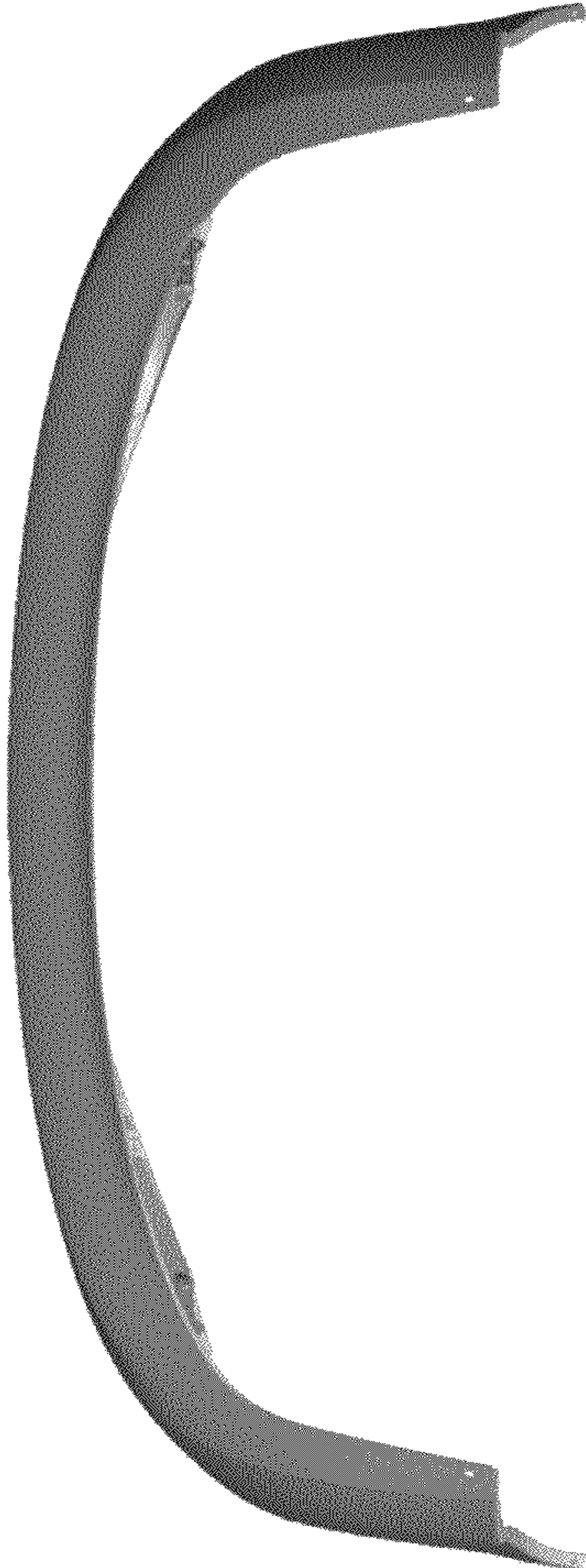

FIG. 5

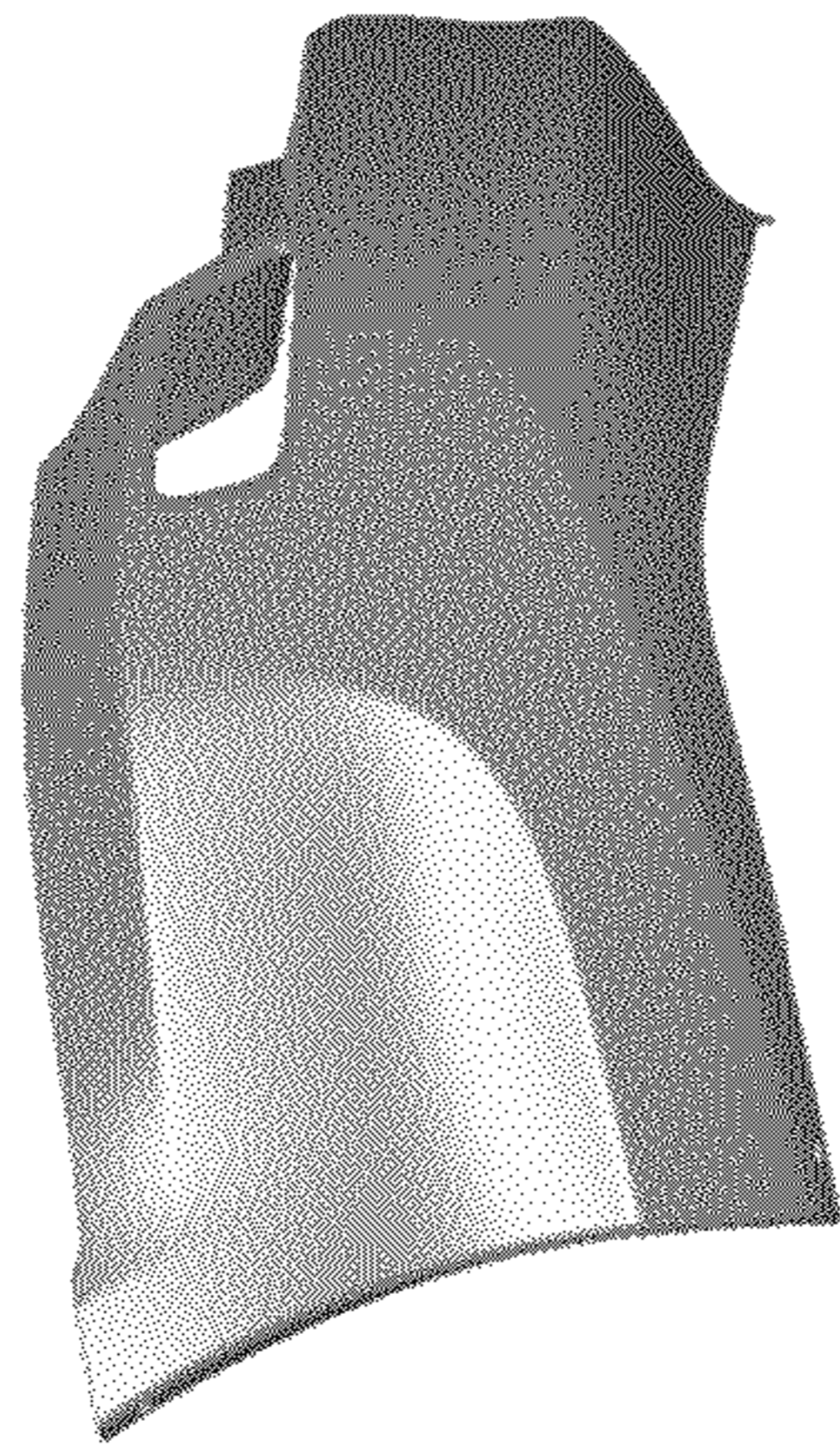

FIG. 7

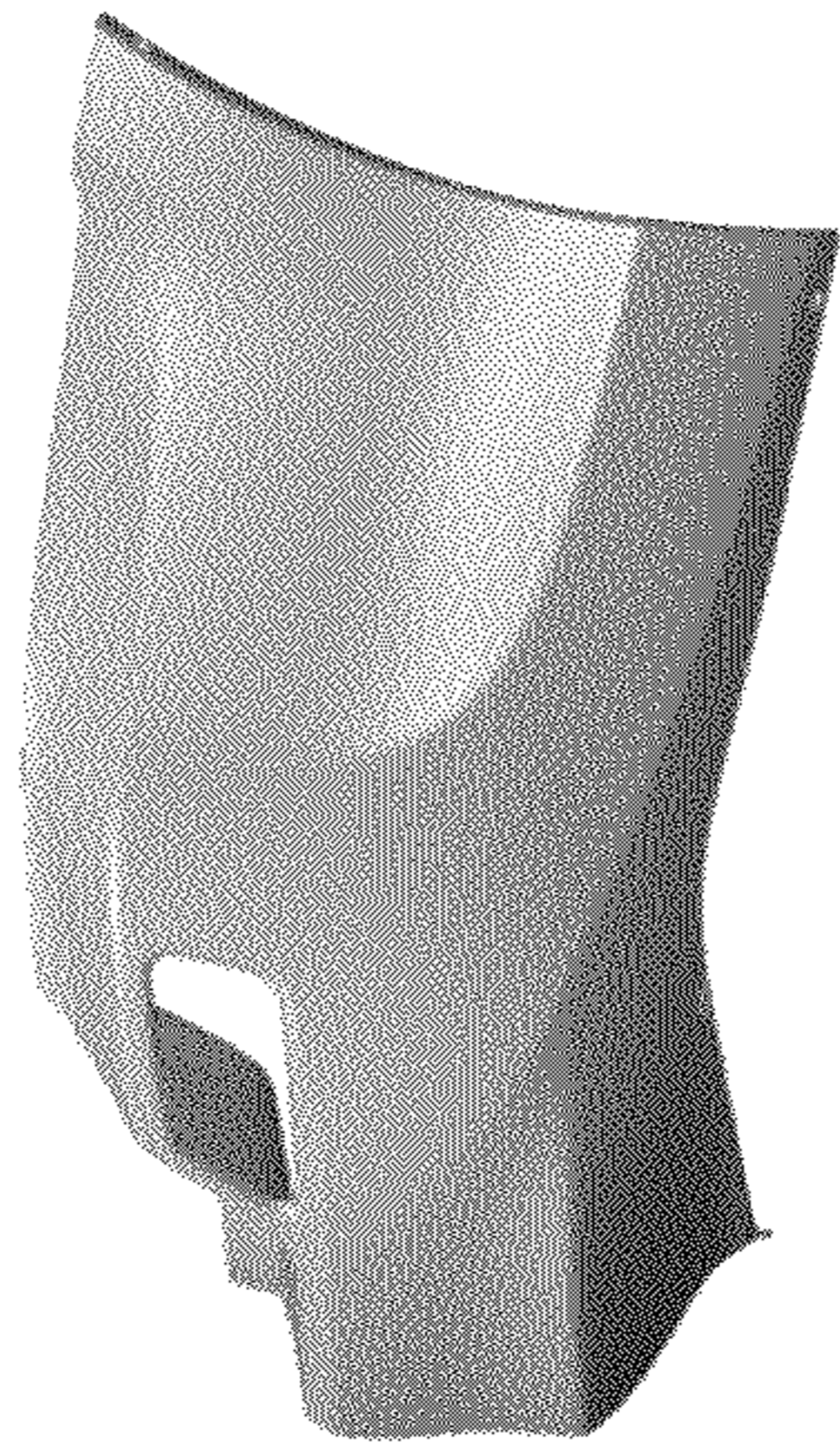

FIG. 6