



US00D699000S

(12) **United States Design Patent**
Bae

(10) **Patent No.:** **US D699,000 S**

(45) **Date of Patent:** **** Feb. 4, 2014**

(54) **RAZOR HANDLE**

(71) Applicant: **Dorco Co., Ltd.**, Seoul (KR)

(72) Inventor: **Seok Min Bae**, Seoul (KR)

(73) Assignee: **Dorco Co., Ltd.**, Seoul (KR)

(**) Term: **14 Years**

(21) Appl. No.: **29/445,532**

(22) Filed: **Feb. 13, 2013**

(30) **Foreign Application Priority Data**

Aug. 17, 2012 (KR) 30-2012-0039446

(51) **LOC (10) Cl.** **28-03**

(52) **U.S. Cl.**
USPC **D28/48**

(58) **Field of Classification Search**
USPC 30/32, 34.05, 34.1-34.2, 41.9, 40-40.2,
30/41, 42-46, 47-52, 57-84, 526-541,
30/346.5-346.61; D28/44-48
See application file for complete search history.

(56) **References Cited**

U.S. PATENT DOCUMENTS

D603,556 S * 11/2009 Rhoad D28/47
D604,906 S * 11/2009 Stowers et al. D28/48

D614,809 S * 4/2010 Bae D28/46
D624,701 S * 9/2010 Jung D28/48
D633,252 S * 2/2011 Wonderley D28/46
D635,718 S * 4/2011 White et al. D28/48
D636,533 S * 4/2011 Andersen et al. D28/48
D659,285 S * 5/2012 Lukan et al. D28/46
D659,286 S * 5/2012 Lukan et al. D28/46
D659,287 S * 5/2012 Psimadas et al. D28/48
D664,714 S * 7/2012 Christie et al. D28/48
D674,552 S * 1/2013 Barrow et al. D28/48
D674,553 S * 1/2013 Barrow et al. D28/48

* cited by examiner

Primary Examiner — Jennifer Rivard

(74) *Attorney, Agent, or Firm* — Morgan, Lewis & Bockius LLP

(57) **CLAIM**

The ornamental design for a razor handle, as shown and described.

DESCRIPTION

FIG. 1 is perspective view of a razor handle showing my new design;
FIG. 2 is front view thereof;
FIG. 3 is rear view thereof;
FIG. 4 is left side view thereof;
FIG. 5 is right side view thereof;
FIG. 6 is top plan view thereof; and,
FIG. 7 is bottom view thereof.

1 Claim, 2 Drawing Sheets

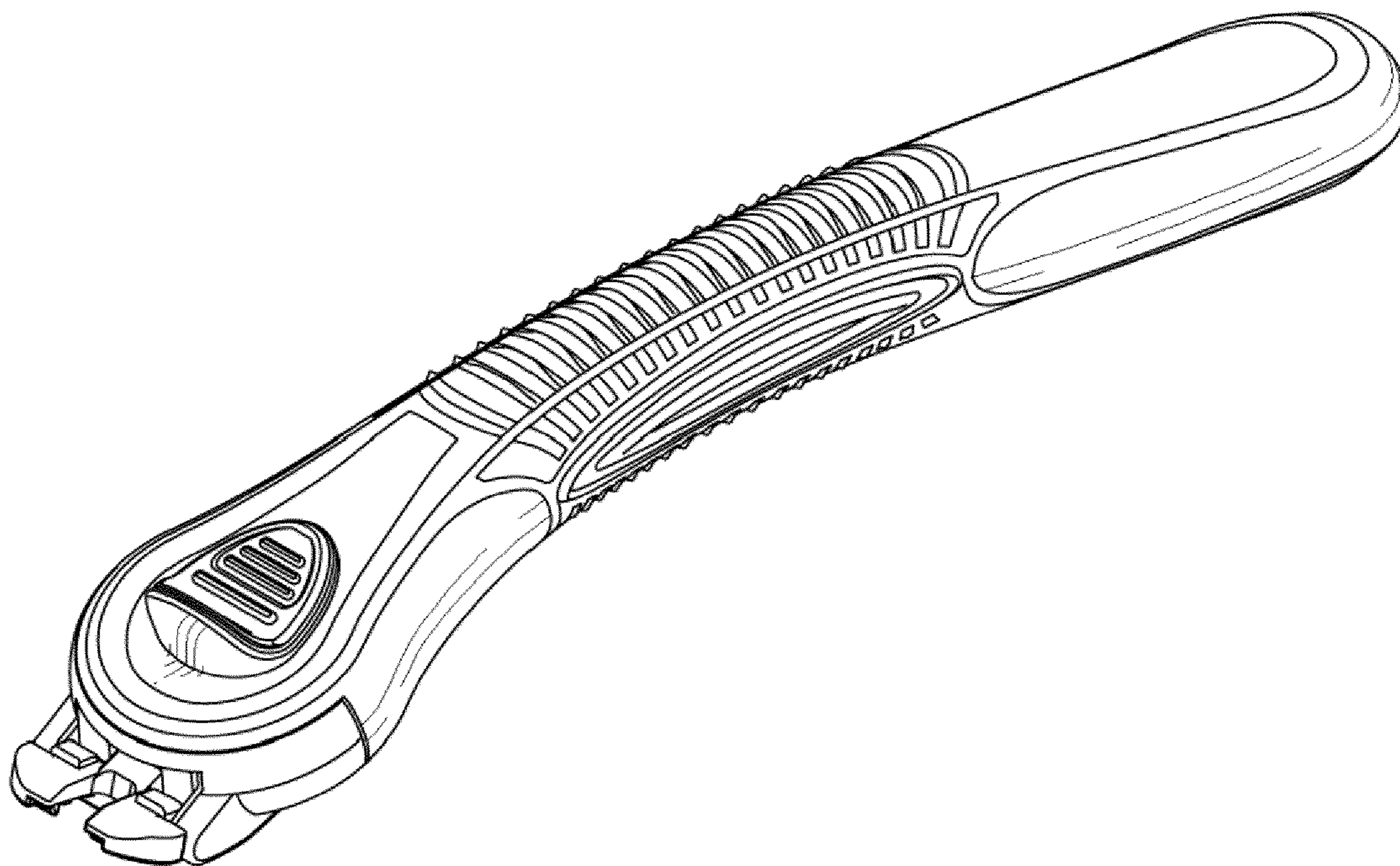

Fig. 1

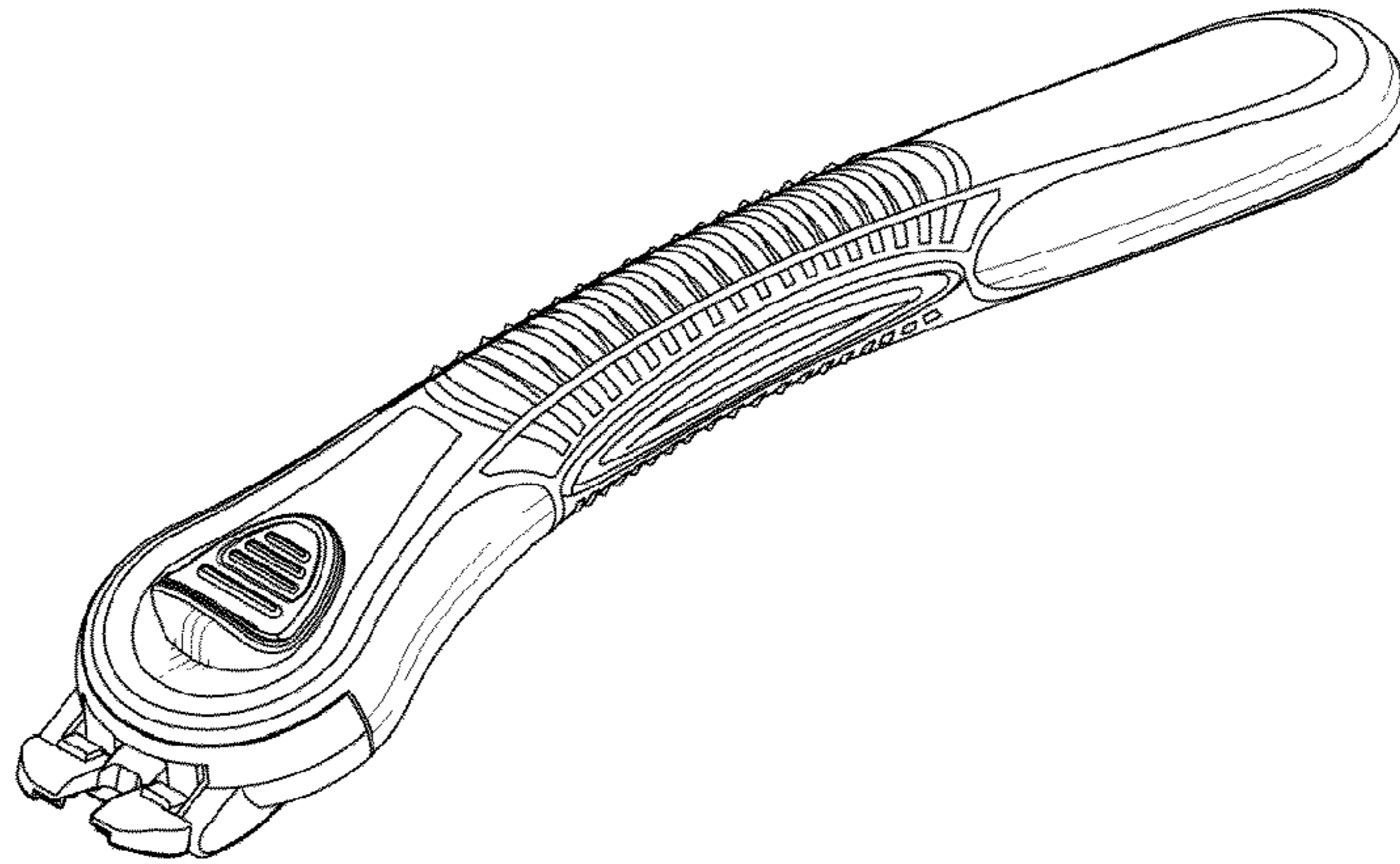

Fig. 2

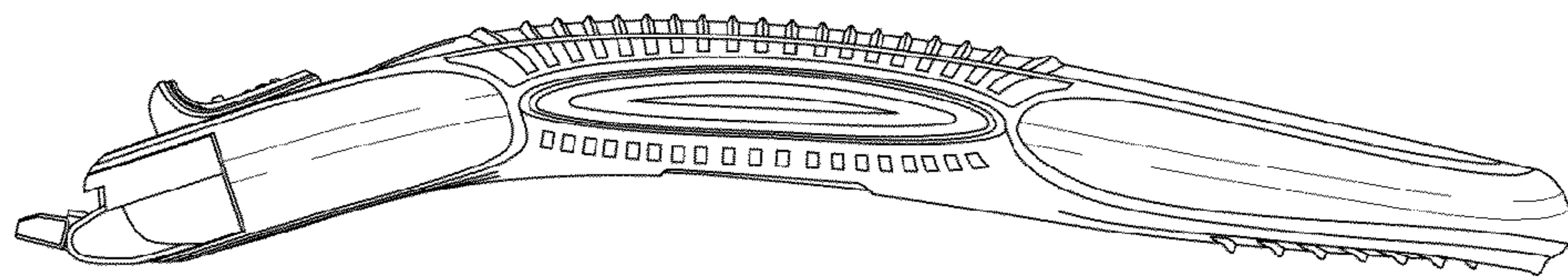

Fig. 3

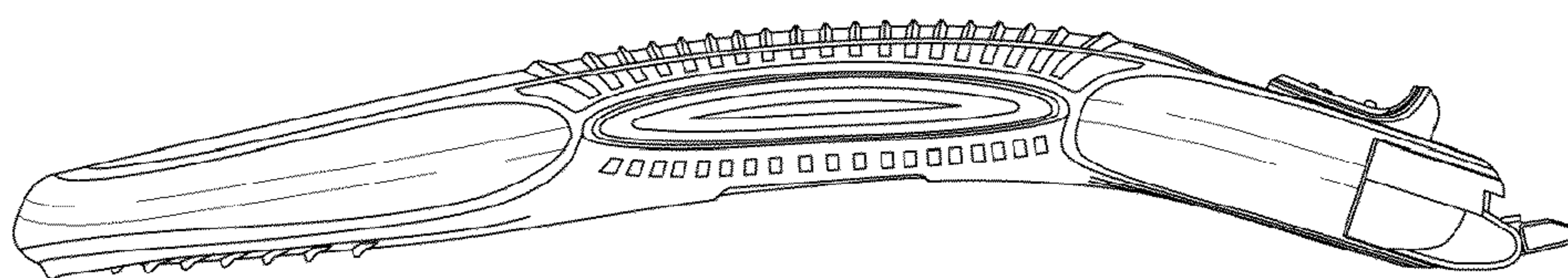

Fig.4

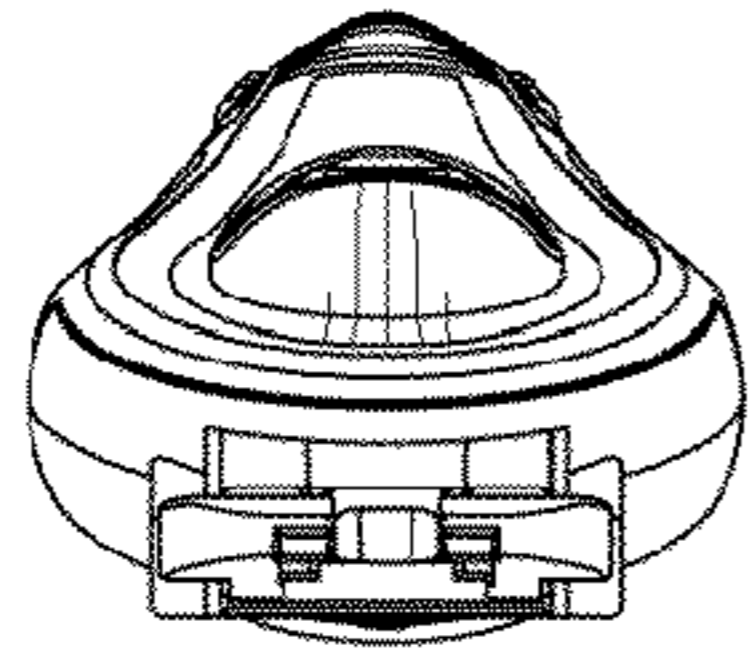

Fig.5

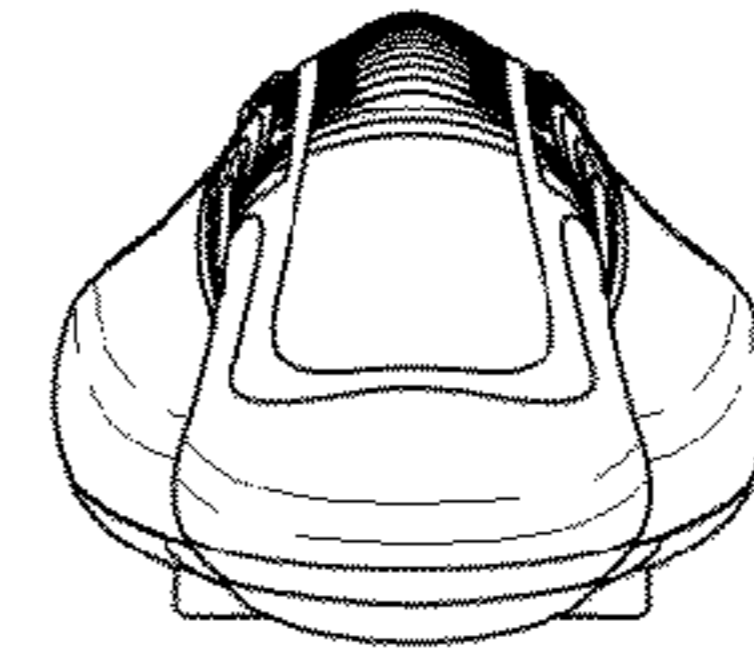

Fig.6

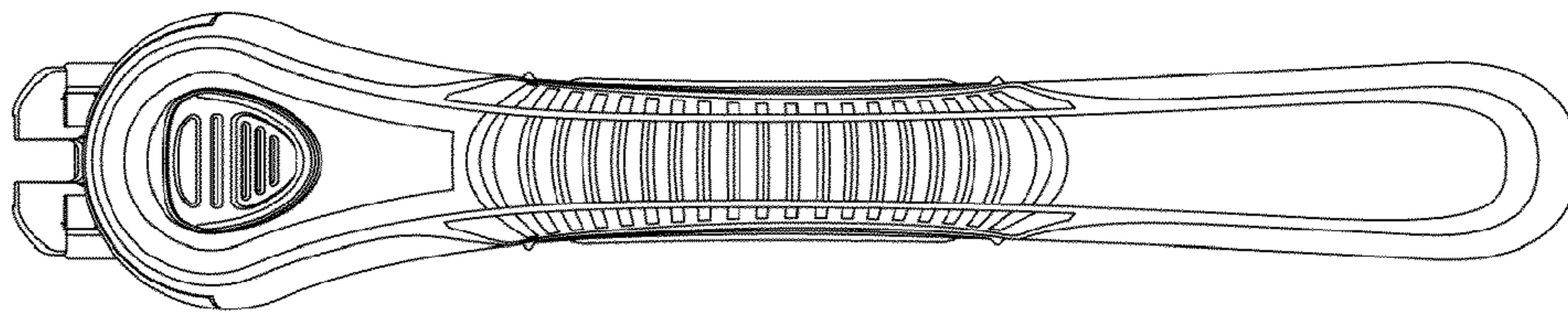

Fig.7

