

US00D698965S

(12) **United States Design Patent**
Helms et al.

(10) **Patent No.:** **US D698,965 S**
(45) **Date of Patent:** **** Feb. 4, 2014**

(54) **LIGHT COVER**

(71) Applicant: **ClaroLux, L.L.C.**, Greensboro, NC
(US)

(72) Inventors: **Brandon Lowry Helms**, Cornelius, NC
(US); **Robert Brian Groat**, Greensboro,
NC (US)

(73) Assignee: **ClaroLux, L.L.C.**, Greensboro, NC
(US)

(**) Term: **14 Years**

(21) Appl. No.: **29/441,314**

(22) Filed: **Jan. 3, 2013**

(51) **LOC (10) Cl.** **26-05**

(52) **U.S. Cl.**
USPC **D26/67**

(58) **Field of Classification Search**
USPC D26/67-72, 118, 134, 135, 136;
362/145, 153, 153.1, 183, 359, 431
See application file for complete search history.

(56) **References Cited**

U.S. PATENT DOCUMENTS

D37,835 S *	2/1906	Mygatt	D26/135
1,755,737 A *	4/1930	Kesselring	362/255
D191,128 S *	8/1961	Curtin et al.	D26/67
D191,534 S *	10/1961	Curtin et al.	D26/67
D426,011 S *	5/2000	Giese et al.	D26/68
D452,028 S *	12/2001	Lee	D26/67
6,422,717 B1 *	7/2002	Beadle	362/285
D488,577 S *	4/2004	Hsu	D26/67
6,874,905 B1 *	4/2005	Beadle	362/153.1
D508,583 S *	8/2005	Carbone	D26/118
D557,848 S *	12/2007	Chen	D26/67

D557,849 S *	12/2007	Chen	D26/67
7,387,409 B1 *	6/2008	Beadle	362/308
D653,785 S *	2/2012	Chen	D26/68
D663,457 S *	7/2012	Ho et al.	D26/67
D676,995 S *	2/2013	Ho et al.	D26/67

* cited by examiner

Primary Examiner — Clare E Heflin

(74) *Attorney, Agent, or Firm* — Michael G. Johnston;
Moore & Van Allen PLLC

(57) **CLAIM**

The ornamental design for a light cover, as shown and described.

DESCRIPTION

FIG. 1 is a top perspective view of a light cover showing our new design.

FIG. 2 is a bottom perspective view of the light cover as shown in FIG. 1 showing our new design.

FIG. 3 is a side elevation view of the light cover as shown in FIG. 1 showing our new design.

FIG. 4 is a center cross-section view of the light cover as shown in FIG. 1 showing our new design.

FIG. 5 is a top plan view of the light cover as shown in FIG. 1 showing our new design.

FIG. 6 is a bottom plan view of the light cover as shown in FIG. 1 showing our new design; and,

FIG. 7 is a side elevation view of the light cover as shown in FIG. 1 and showing the other light components showing our new design.

The portions shown in broken lines are not part of the claimed design but show the environment in which the design is associated.

1 Claim, 5 Drawing Sheets

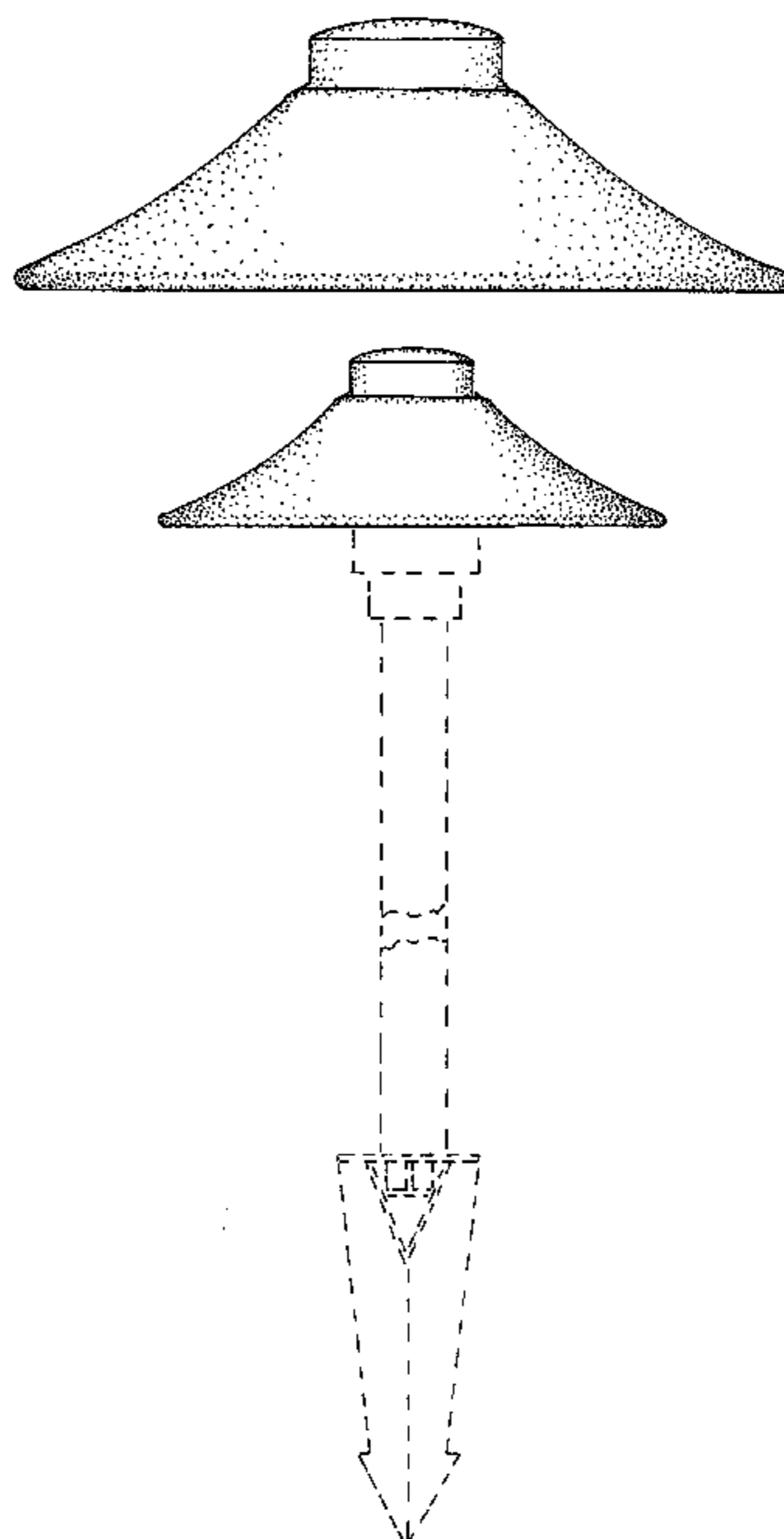

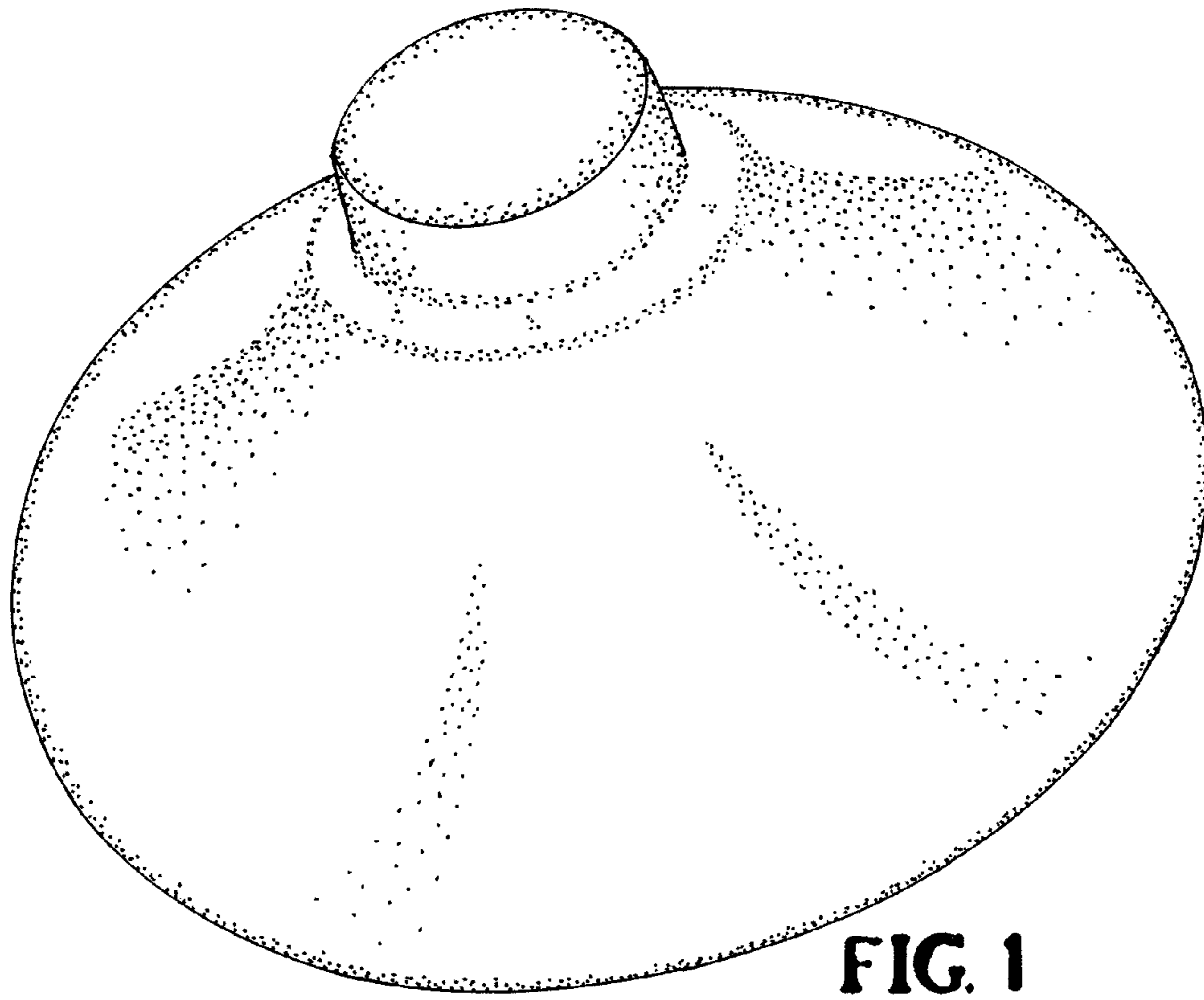

FIG. 1

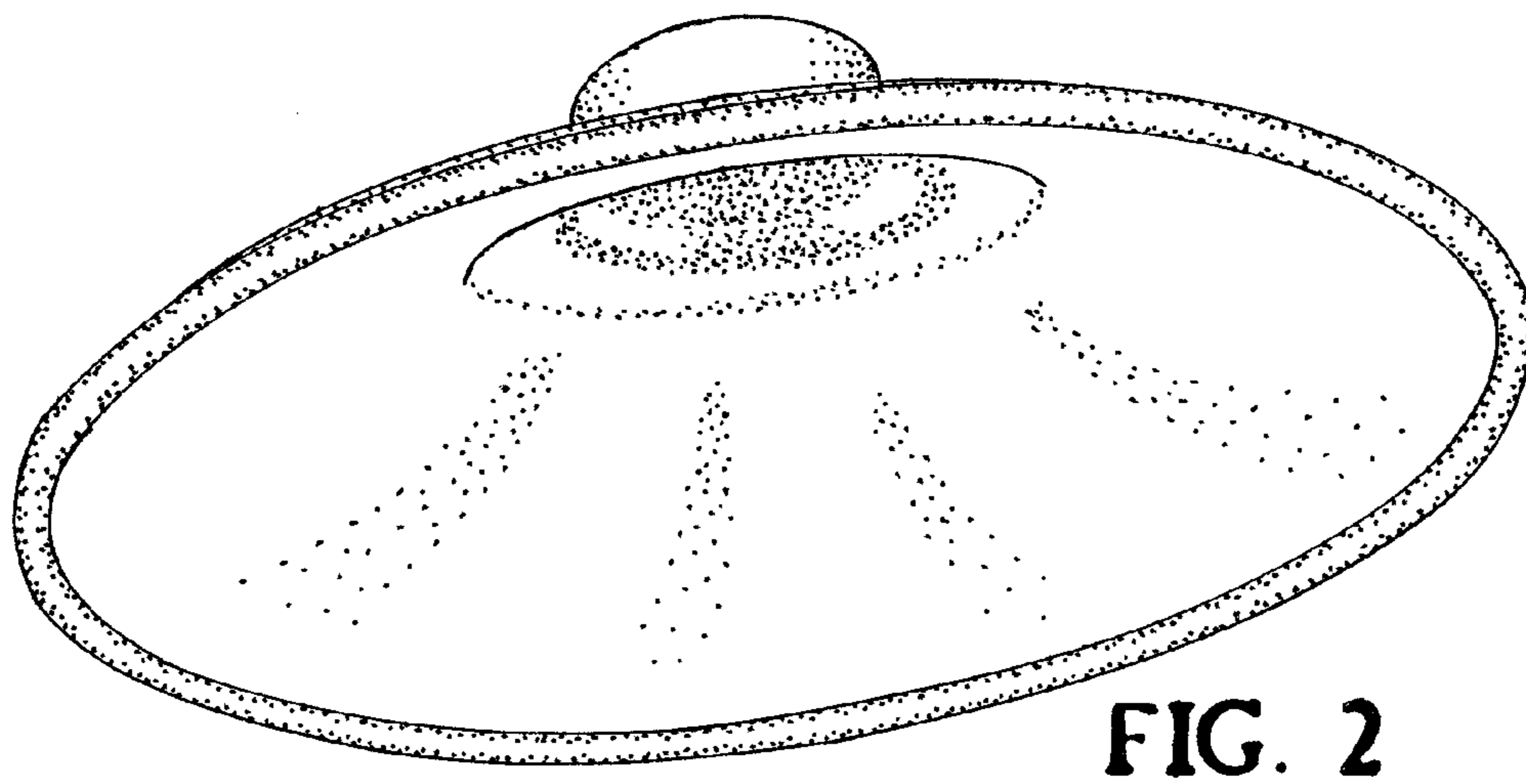

FIG. 2

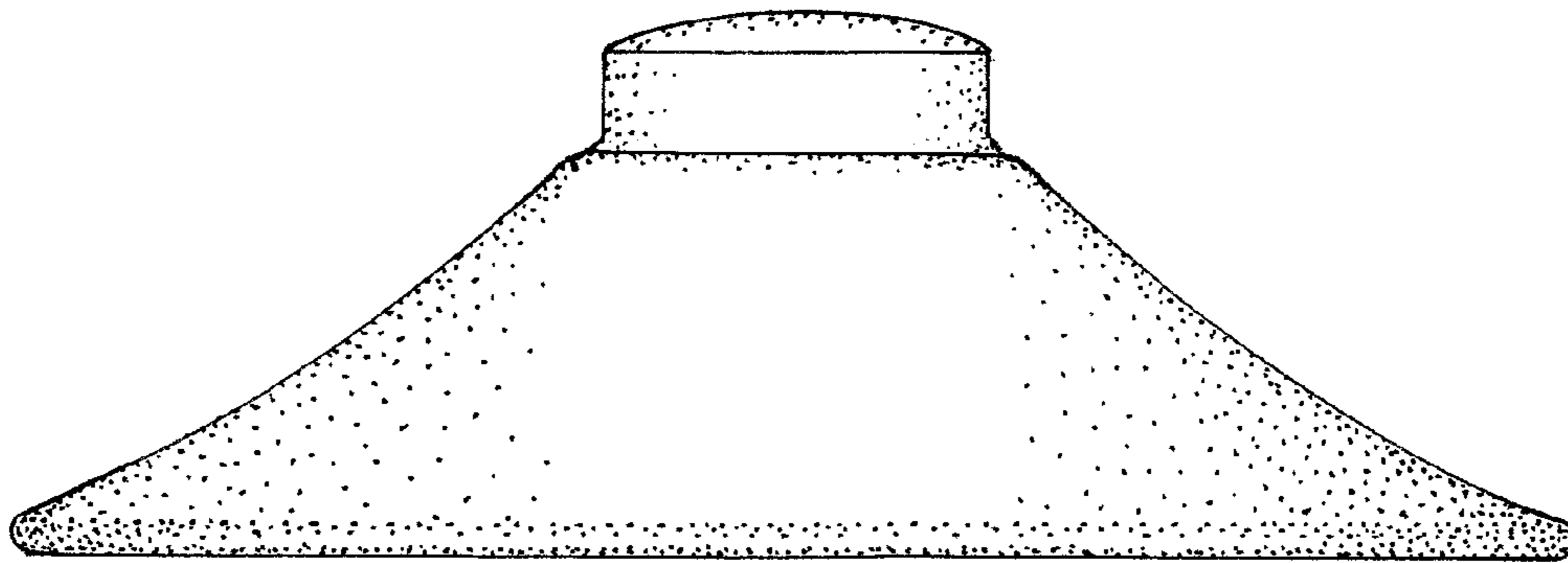

FIG. 3

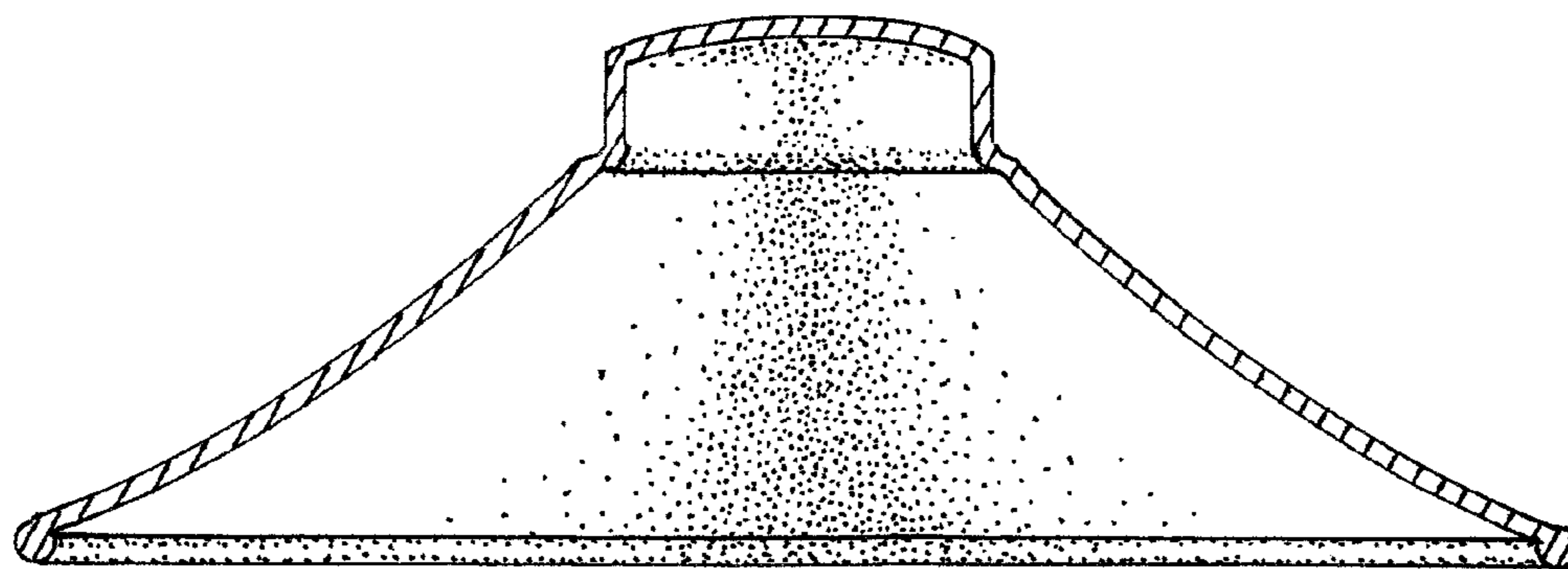

FIG. 4

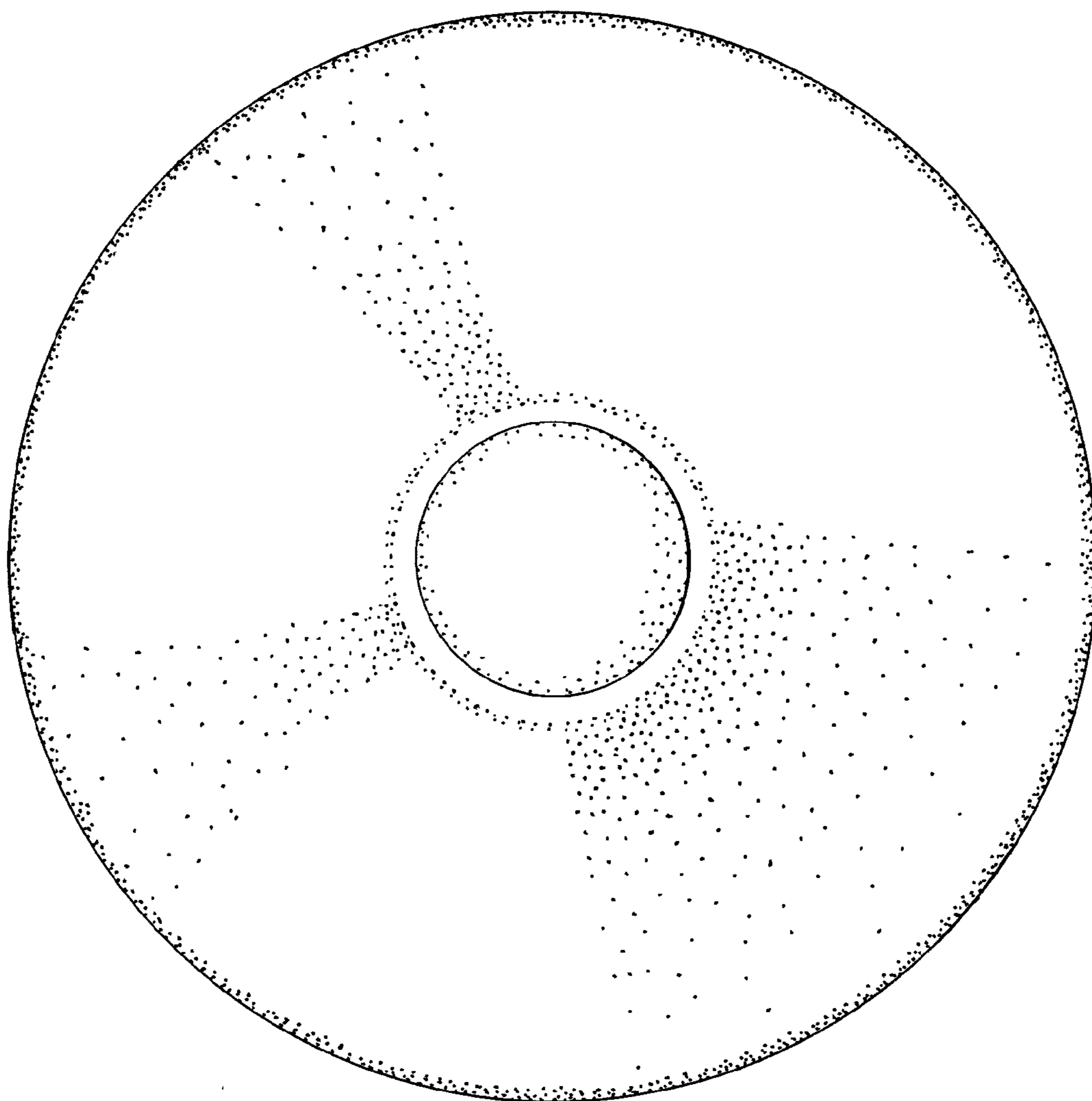

FIG. 5

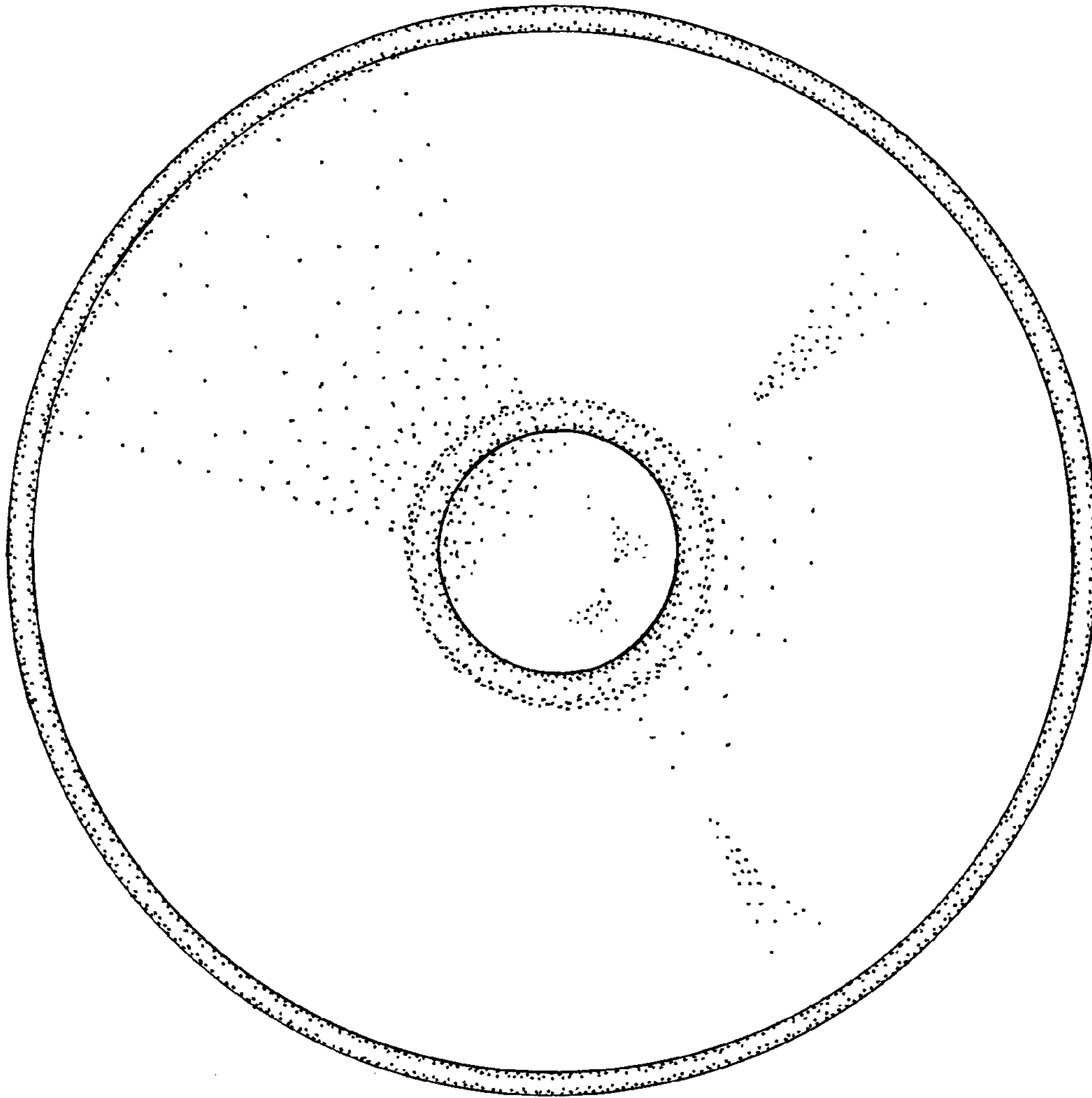

FIG. 6

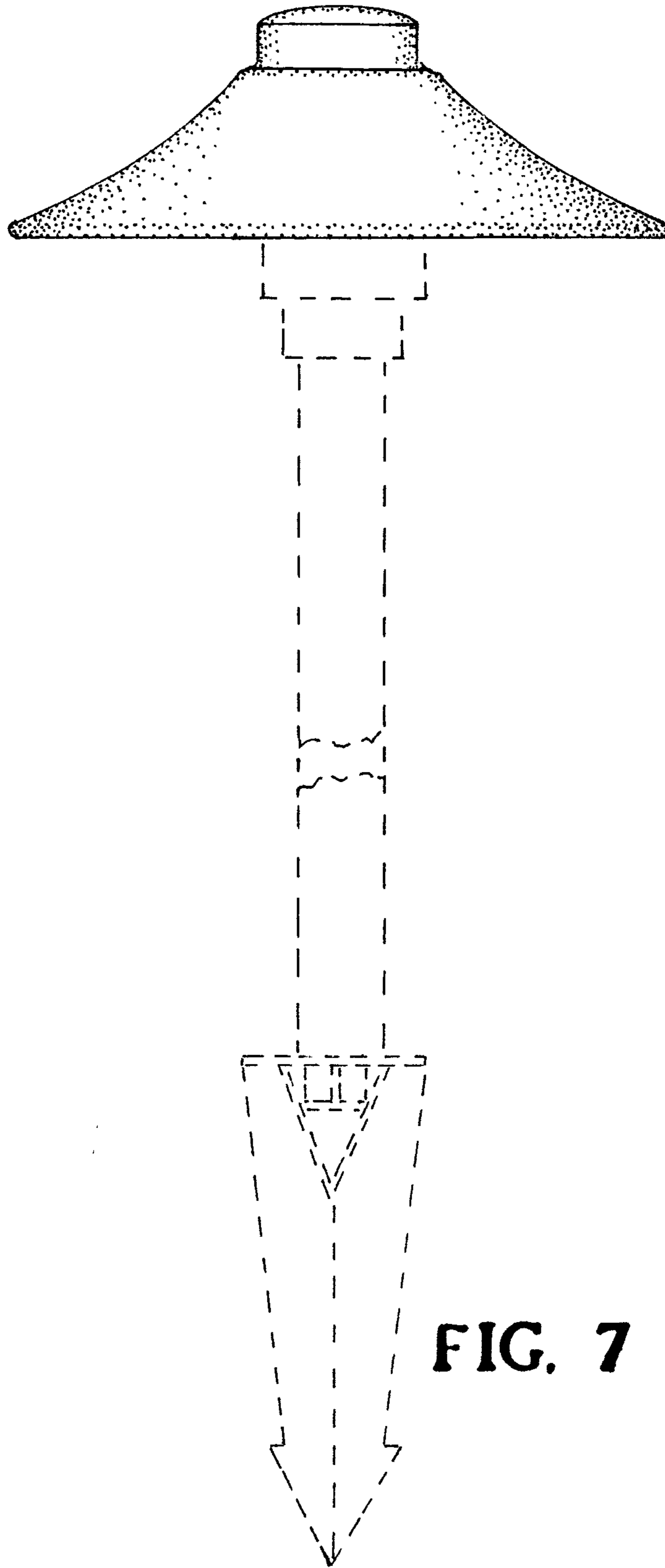

FIG. 7