



US00D698745S

(12) **United States Design Patent**
Jung et al.

(10) **Patent No.:** **US D698,745 S**
(45) **Date of Patent:** **** Feb. 4, 2014**

(54) **TELEVISION RECEIVER**

(71) Applicant: **Samsung Electronics Co., Ltd.**,
Suwon-si (KR)
(72) Inventors: **Dae-Hun Jung**, Seoul (KR); **Yong-Joo Lee**, Seoul (KR)
(73) Assignee: **Samsung Electronics Co., Ltd.**,
Suwon-si (KR)

(**) Term: **14 Years**

(21) Appl. No.: **29/459,920**

(22) Filed: **Jul. 4, 2013**

(30) **Foreign Application Priority Data**

Jan. 5, 2013 (KR) 30-2013-0000765

(51) **LOC (10) Cl.** **14-03**

(52) **U.S. Cl.**
USPC **D14/126**

(58) **Field of Classification Search**
USPC D14/125-134, 239, 371, 136, 374-377,
D14/432, 450, 448, 336; 312/7.2; 348/836,
348/838, 180, 184, 325, 739; 341/12;
248/917-924; 345/104, 133, 156, 168,
345/87, 173; 720/600, 605; 369/197;
455/344, 347; D21/329, 515, 333;
D6/300, 512; 273/148 B; D10/15, 26

See application file for complete search history.

(56) **References Cited**

U.S. PATENT DOCUMENTS

D556,756 S *	12/2007	Kataoka et al.	D14/375
D580,384 S *	11/2008	Katayama et al.	D14/126
D649,950 S *	12/2011	Chiu	D14/126
D655,266 S *	3/2012	Kim	D14/126
D671,513 S *	11/2012	Jang et al.	D14/126
D678,853 S *	3/2013	Kim et al.	D14/126
D680,982 S *	4/2013	Lee et al.	D14/126
D682,233 S *	5/2013	Yoo et al.	D14/126
D683,710 S *	6/2013	Jeon et al.	D14/126

* cited by examiner

Primary Examiner — Randall Gholson
(74) *Attorney, Agent, or Firm* — NSIP Law

(57) **CLAIM**

The ornamental design for a television receiver, as shown and described.

DESCRIPTION

FIG. 1 is a perspective view of a television receiver, showing our new design;
FIG. 2 is a front view thereof;
FIG. 3 is a rear view thereof;
FIG. 4 is a left-side view thereof;
FIG. 5 is a right-side view thereof;
FIG. 6 is a top plan view thereof;
FIG. 7 is a bottom plan view thereof;
FIG. 8 is a rear perspective view thereof; and,
FIG. 9 is another left-side view thereof, in which a display part of the television receiver rotates to a first position to illustrate an alternate position.
The broken lines show unclaimed subject matter and form no part of the claimed design.

1 Claim, 7 Drawing Sheets

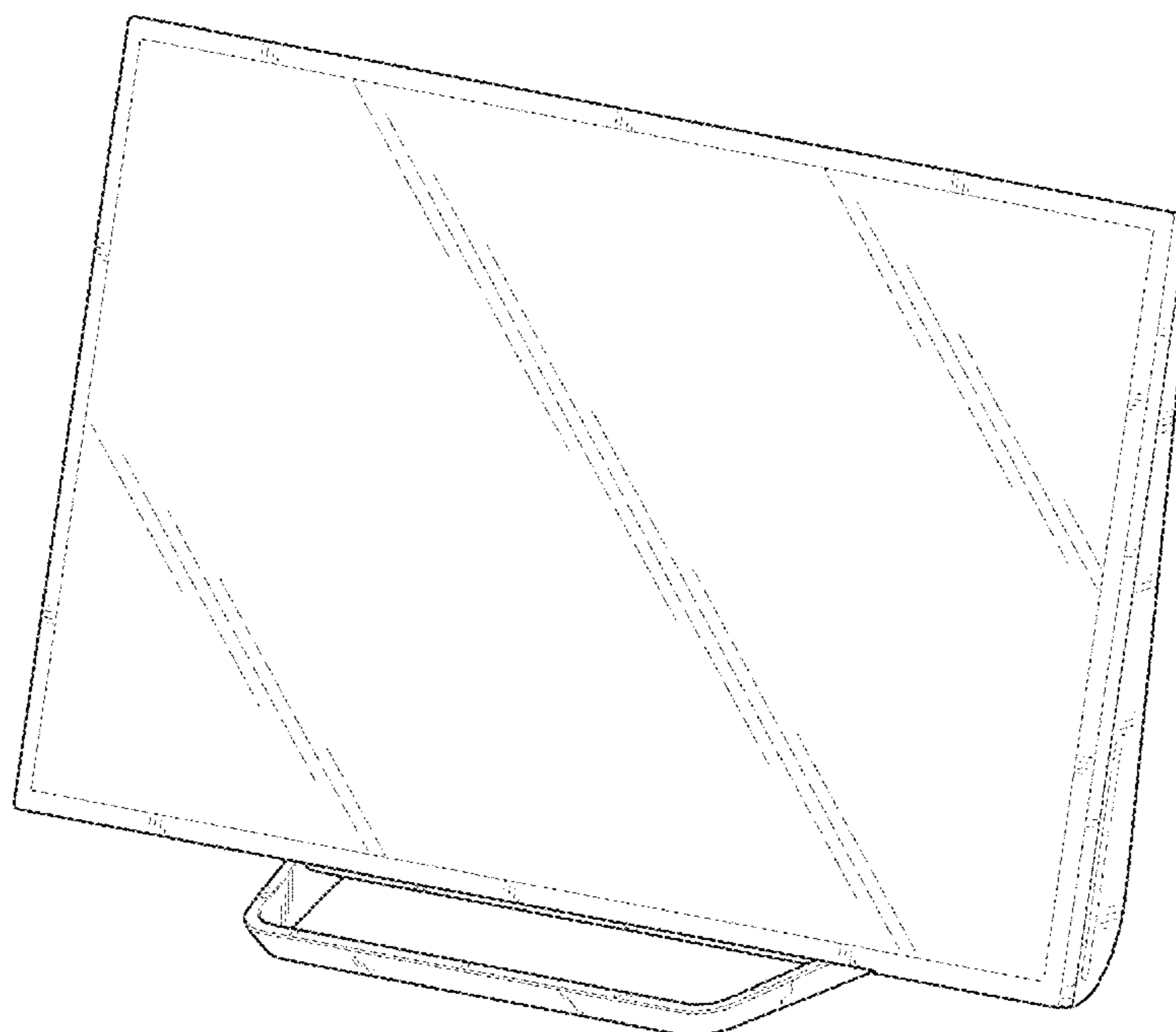

FIG. 1

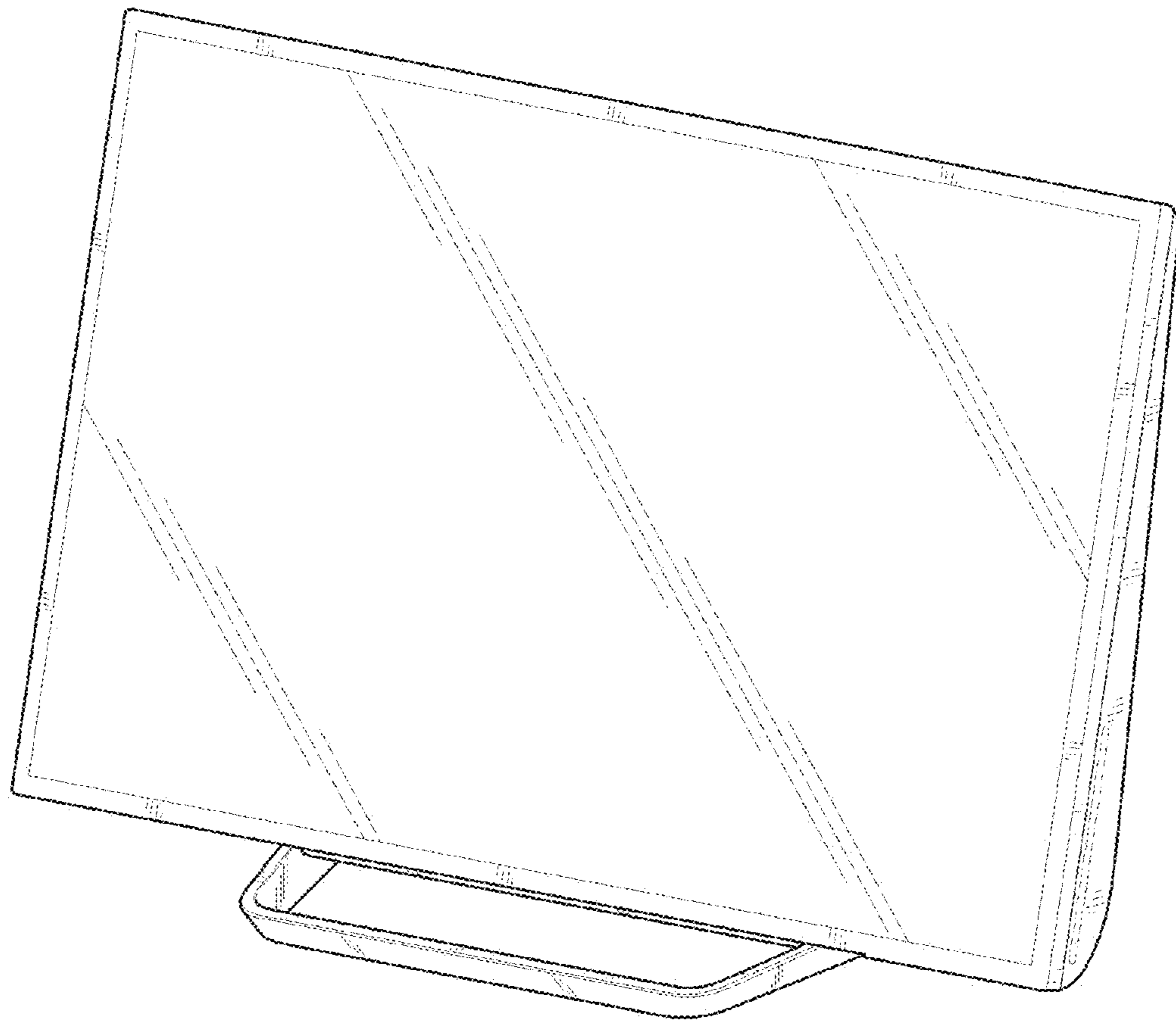

FIG. 2

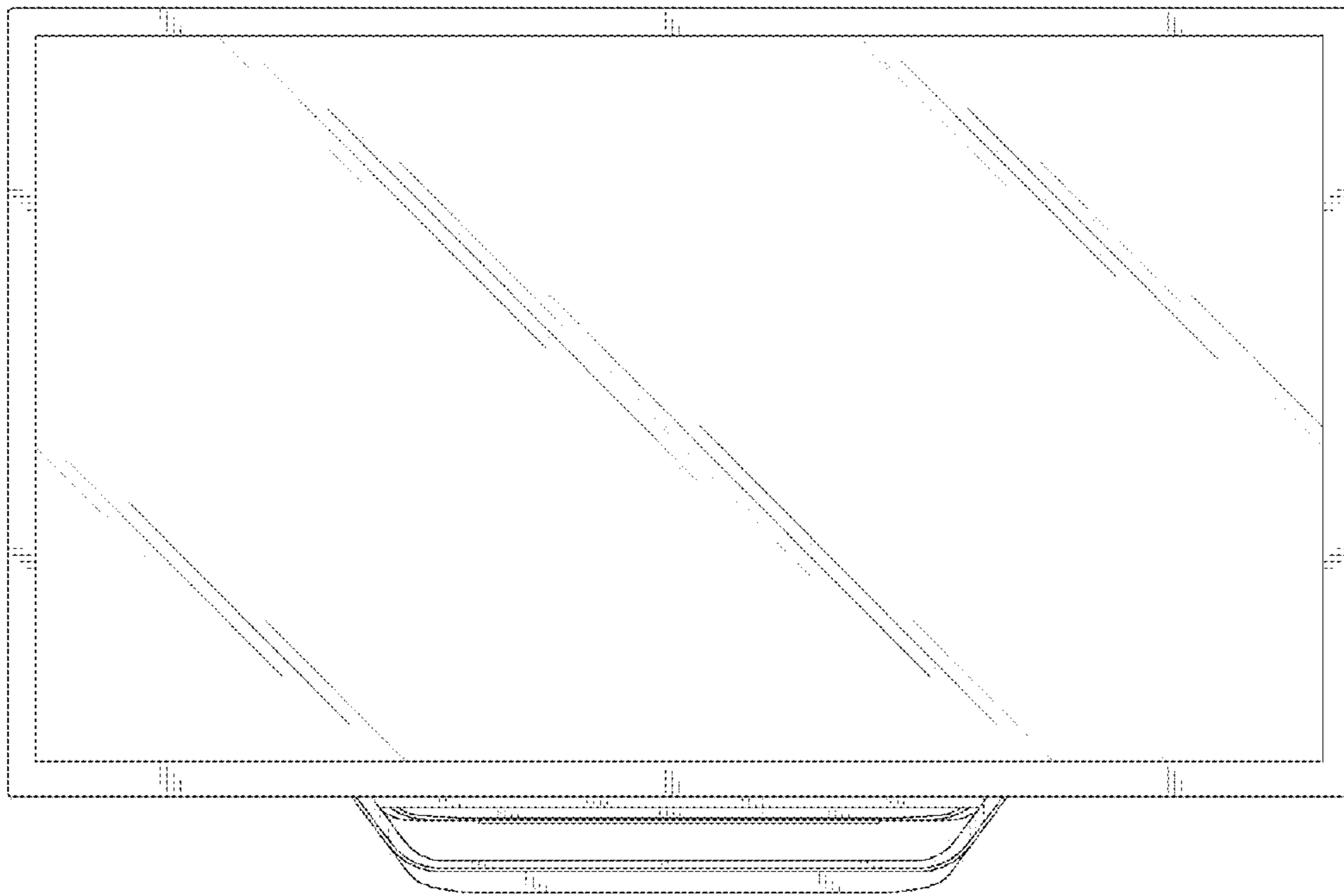

FIG. 3

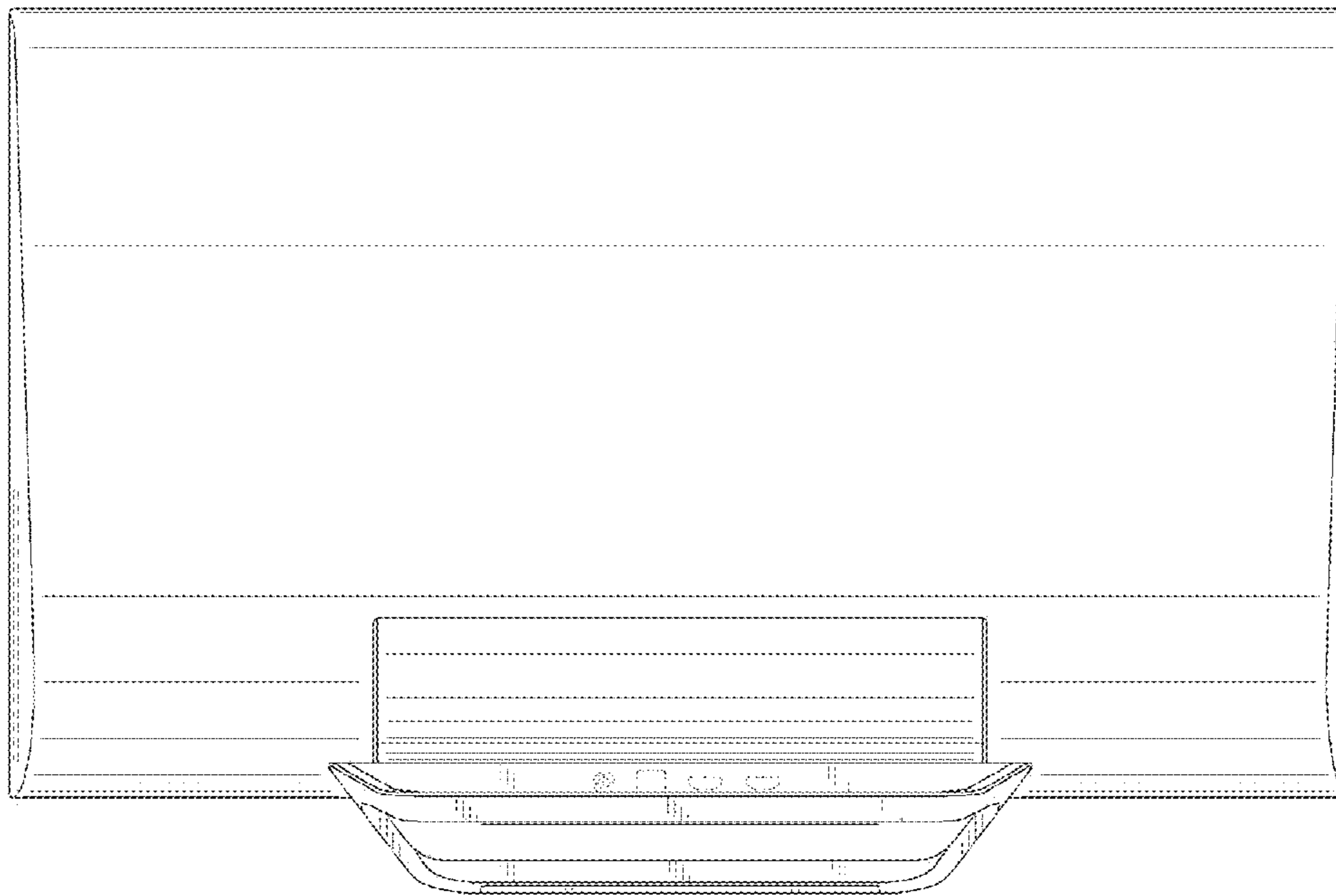

FIG. 4

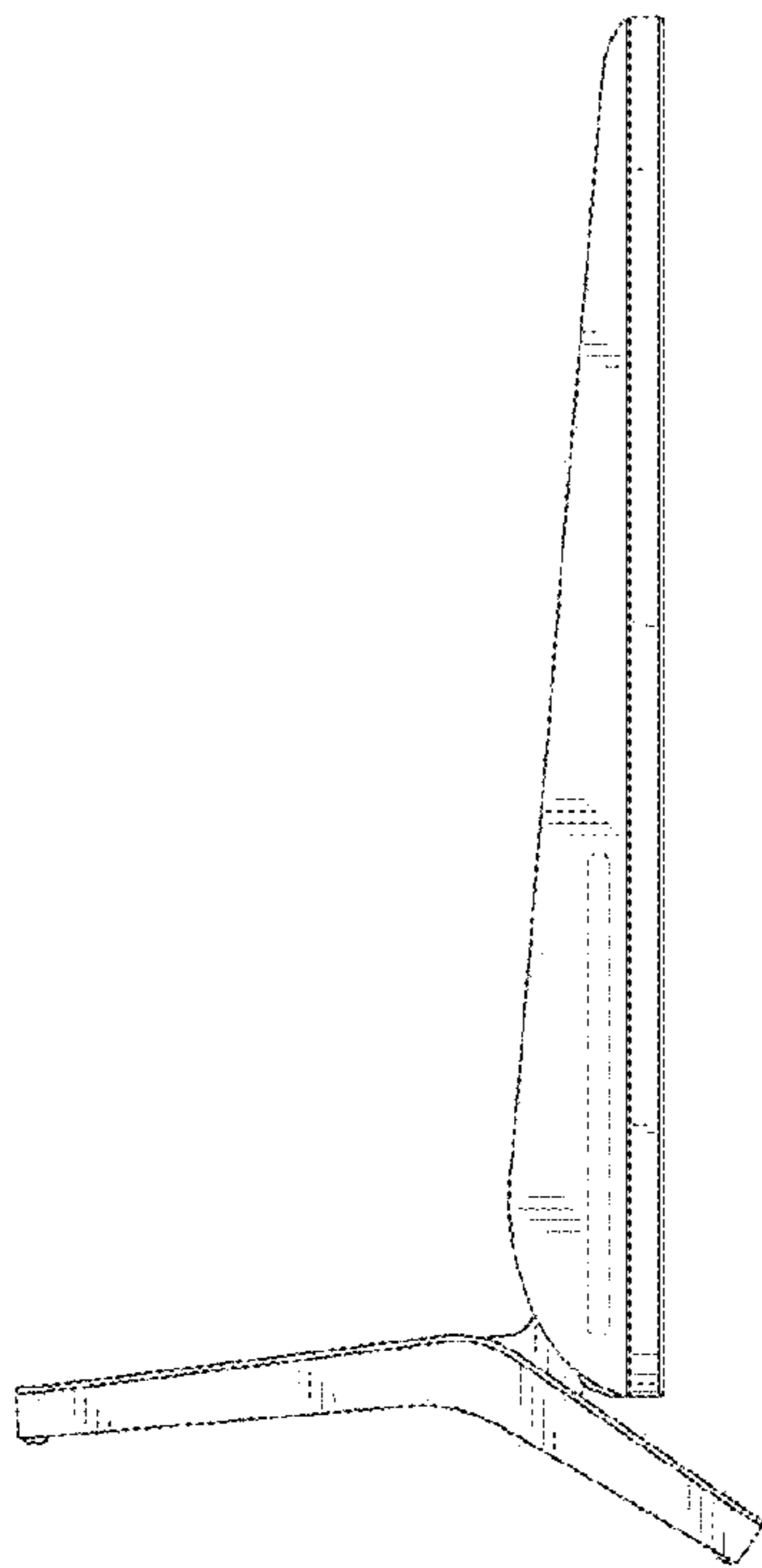

FIG. 5

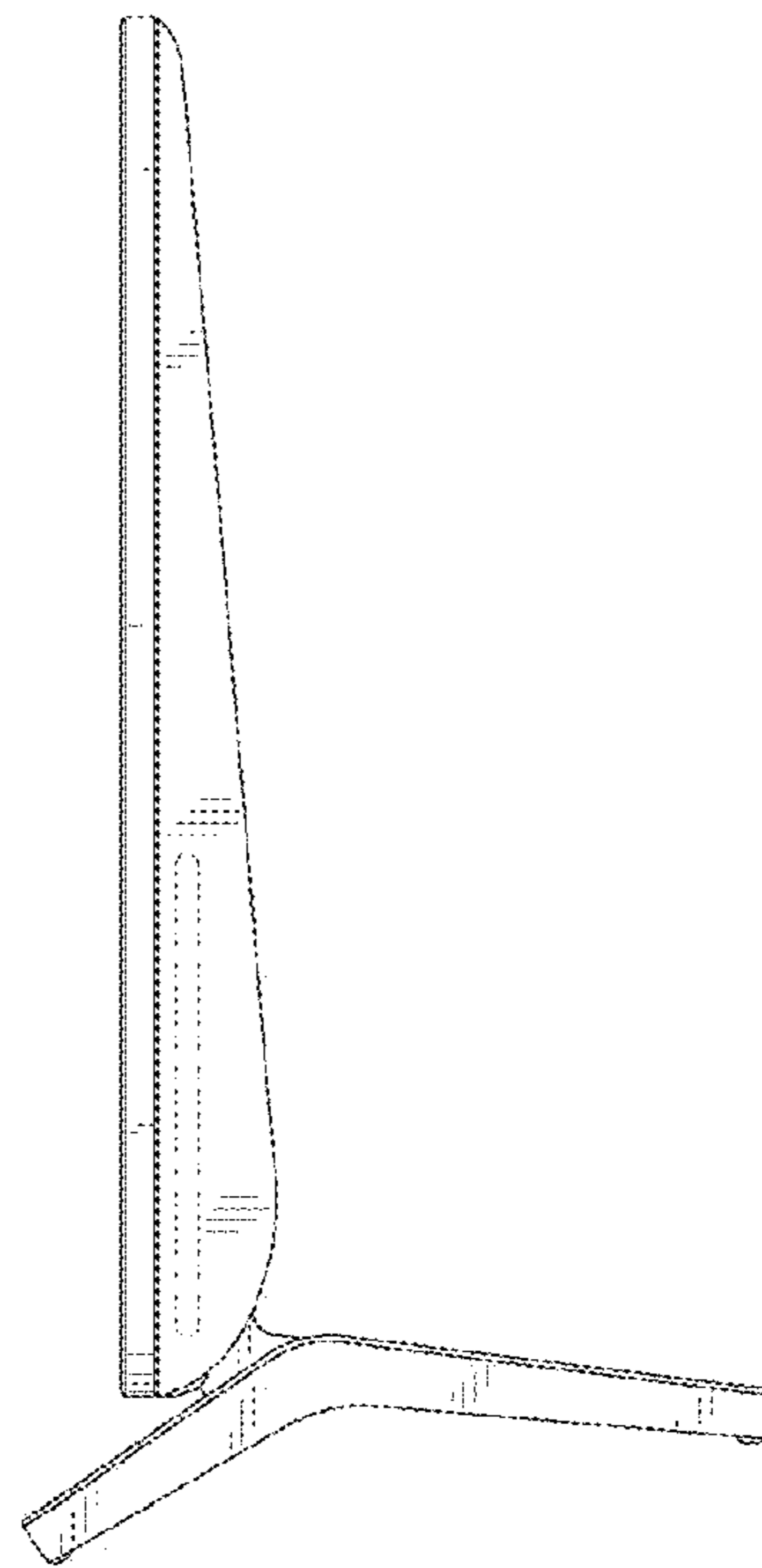

FIG. 6

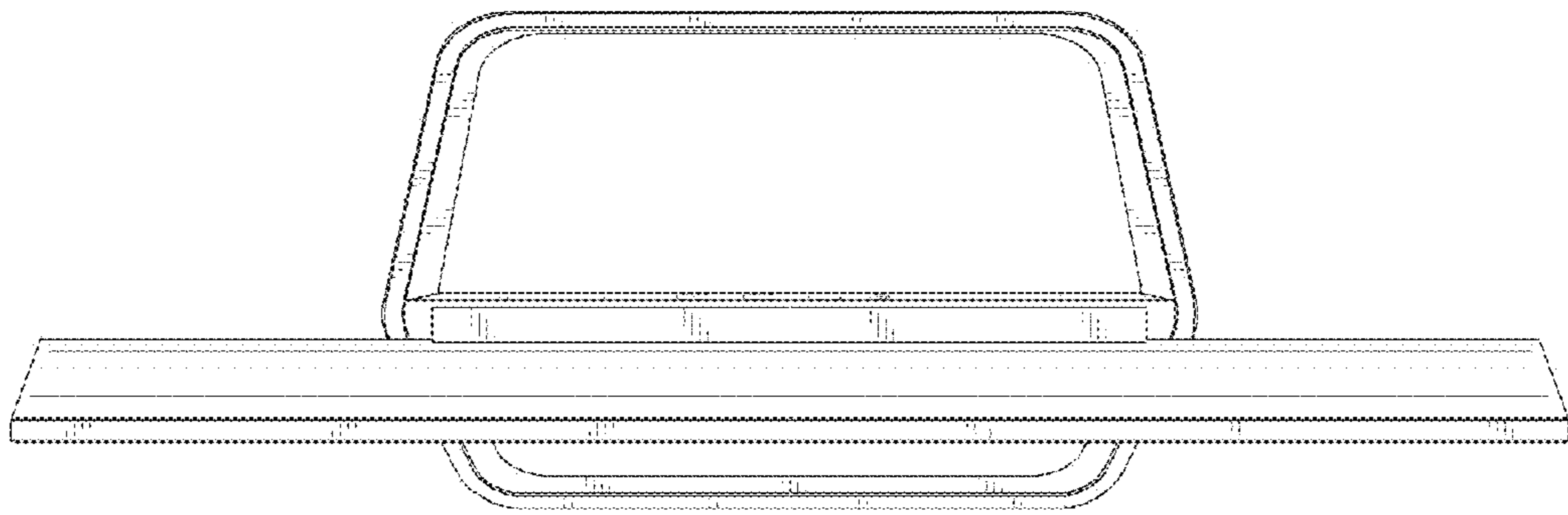

FIG. 7

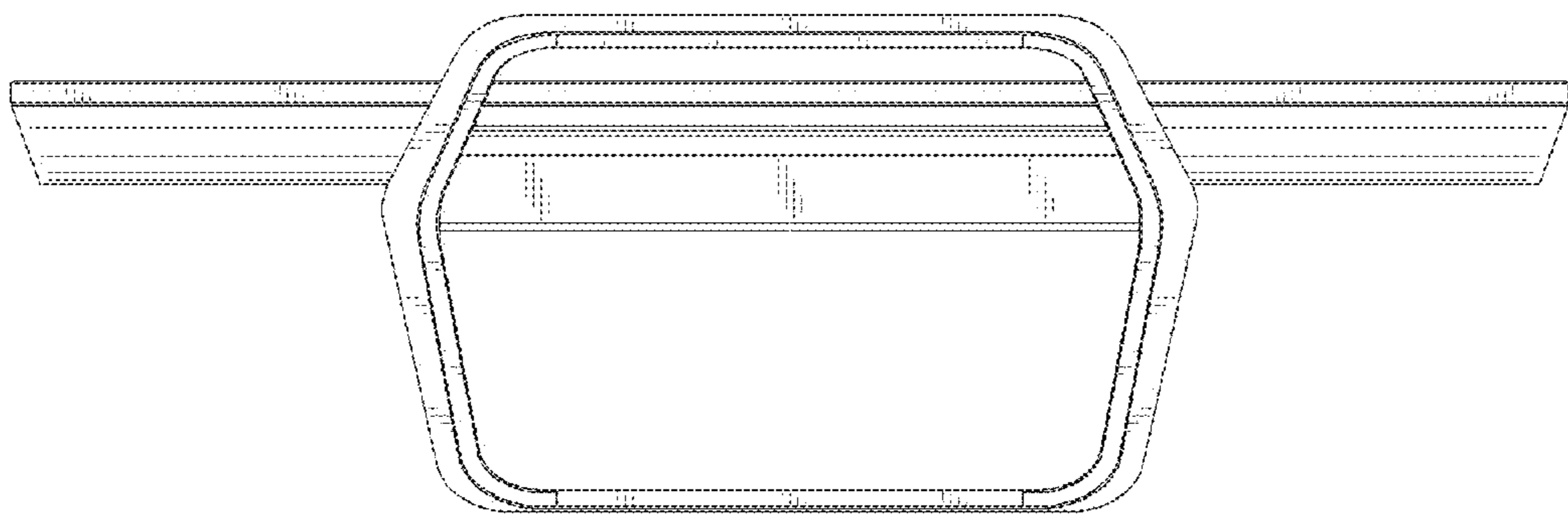

FIG. 8

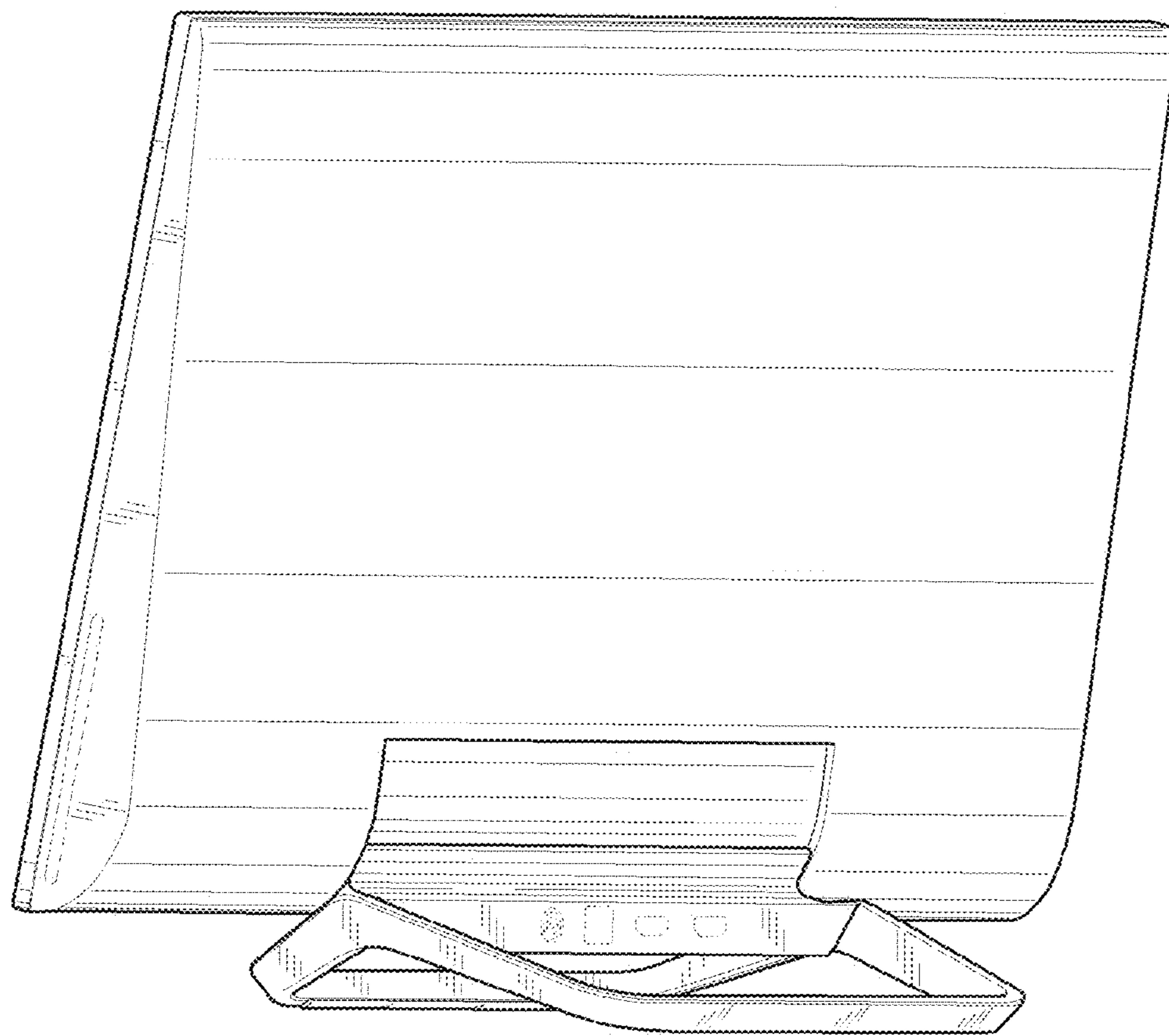

FIG. 9

