



US00D698722S

(12) **United States Design Patent**
Baru

(10) **Patent No.:** **US D698,722 S**
(45) **Date of Patent:** **** Feb. 4, 2014**

(54) **WATERCRAFT**

(71) Applicant: **Eran Baru**, Tel Aviv (IL)

(72) Inventor: **Eran Baru**, Tel Aviv (IL)

(**) Term: **14 Years**

(21) Appl. No.: **29/446,878**

(22) Filed: **Feb. 28, 2013**

(51) **LOC (10) Cl.** **12-06**

(52) **U.S. Cl.**
USPC **D12/307; D12/300**

(58) **Field of Classification Search**
USPC D12/300, 302-304, 314, 316; 114/61.1,
114/61.12, 61.2, 61.32, 271, 272, 288-291,
114/344, 345, 355-357; D21/769, 770;
441/65

See application file for complete search history.

(56) **References Cited**

U.S. PATENT DOCUMENTS

D330,928 S *	11/1992	Sameshima	D21/770
D355,400 S *	2/1995	Montgomery	D12/307
D358,121 S *	5/1995	Price	D12/300
D367,638 S *	3/1996	Duncan	D12/300
D396,684 S *	8/1998	Frigard	D12/304
D407,366 S *	3/1999	Badsey	D12/300
D427,136 S *	6/2000	Roy et al.	D12/300

D476,941 S *	7/2003	Prevost	D12/307
D577,325 S *	9/2008	Harman	D12/300
D630,148 S *	1/2011	Christen	D12/300
D689,813 S *	9/2013	Christen	D12/307

* cited by examiner

Primary Examiner — Cynthia M Chin

(74) *Attorney, Agent, or Firm* — Mark M. Friedman

(57) **CLAIM**

The ornamental design for a watercraft, as shown and described.

DESCRIPTION

FIG. 1 is a side view of a watercraft showing my design; FIG. 2 is a top view (open) thereof; FIG. 3 is a bottom view (open) thereof; FIG. 4 is a back view (open) thereof; FIG. 5 is a front view (open) thereof; FIG. 6 is an isometric back view (open) thereof; FIG. 7 is an isometric front view (open) thereof; FIG. 8 is a front view (closed) thereof; FIG. 9 is a back view (closed) thereof; FIG. 10 is a side view (closed) thereof; FIG. 11 is a top view (closed) thereof; FIG. 12 is a bottom view (closed) thereof; FIG. 13 is an isometric front view (closed) thereof; and, FIG. 14 is an isometric back view (closed) thereof.

1 Claim, 14 Drawing Sheets

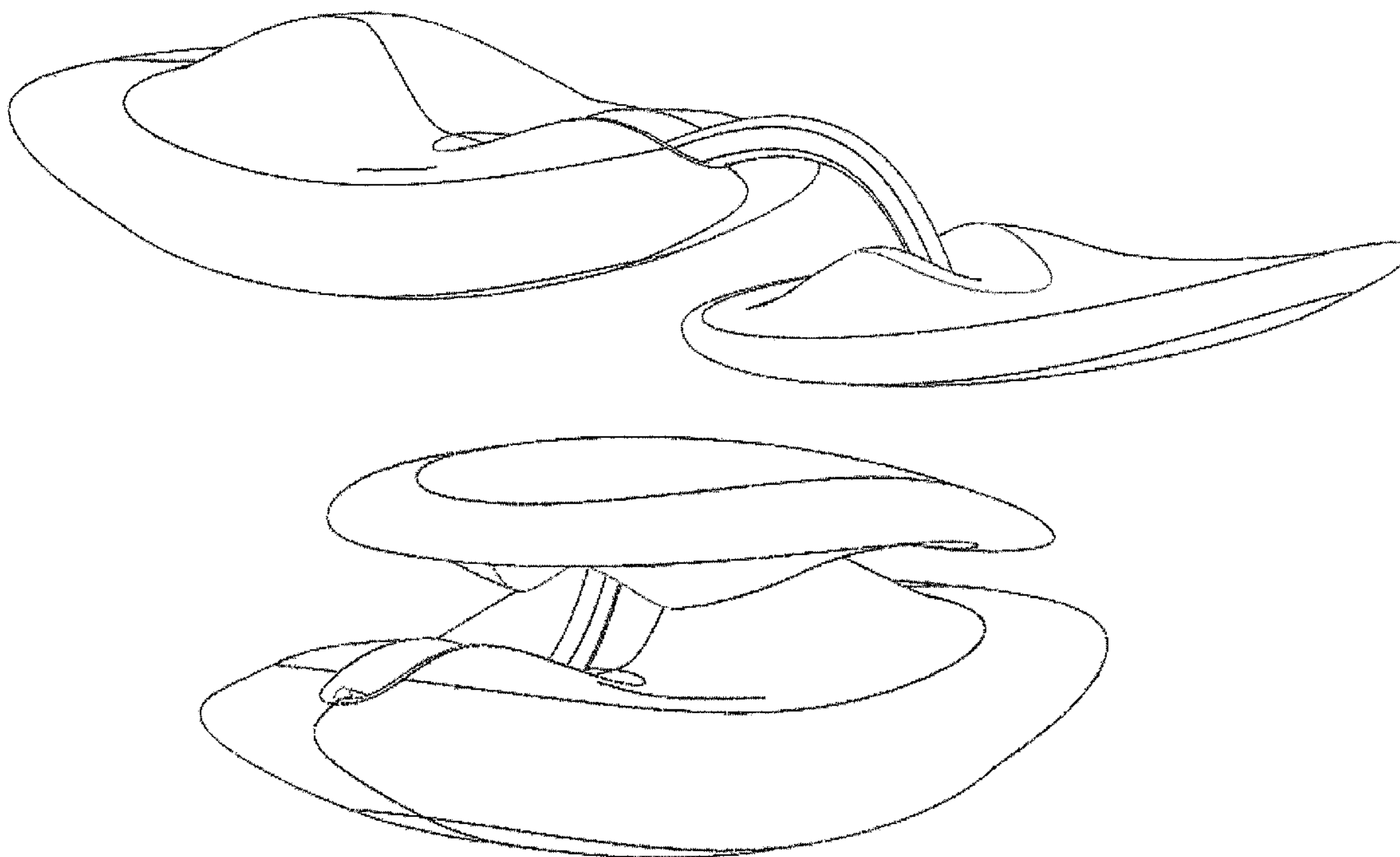



FIG. 1

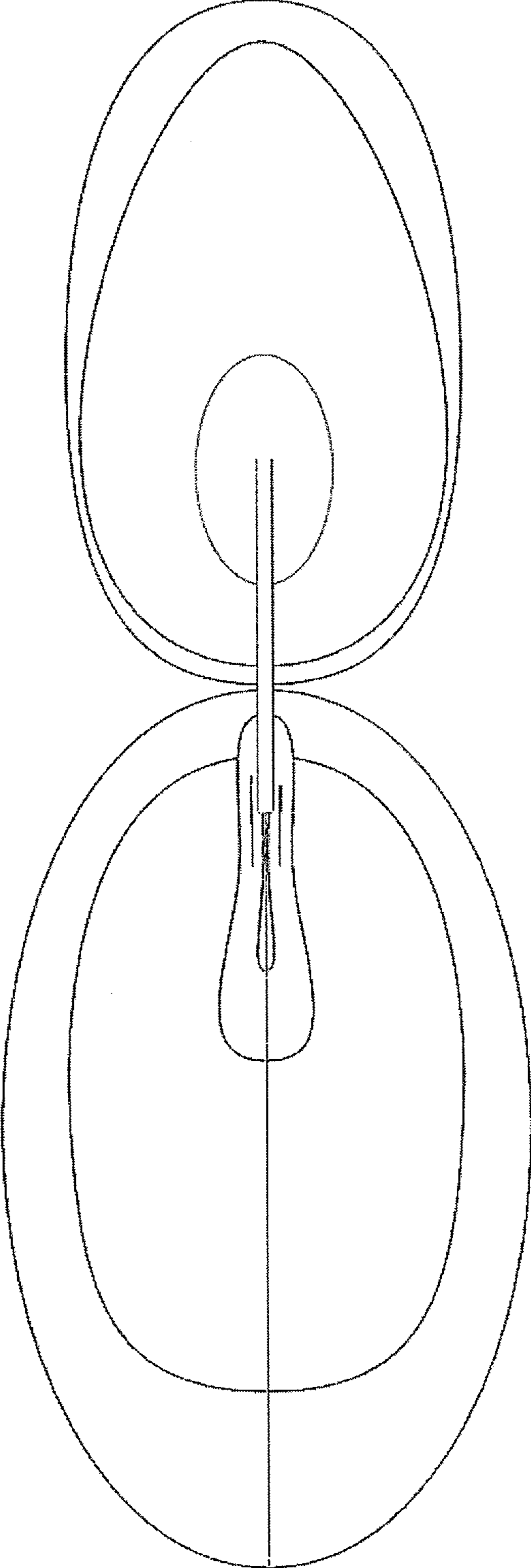

FIG. 2

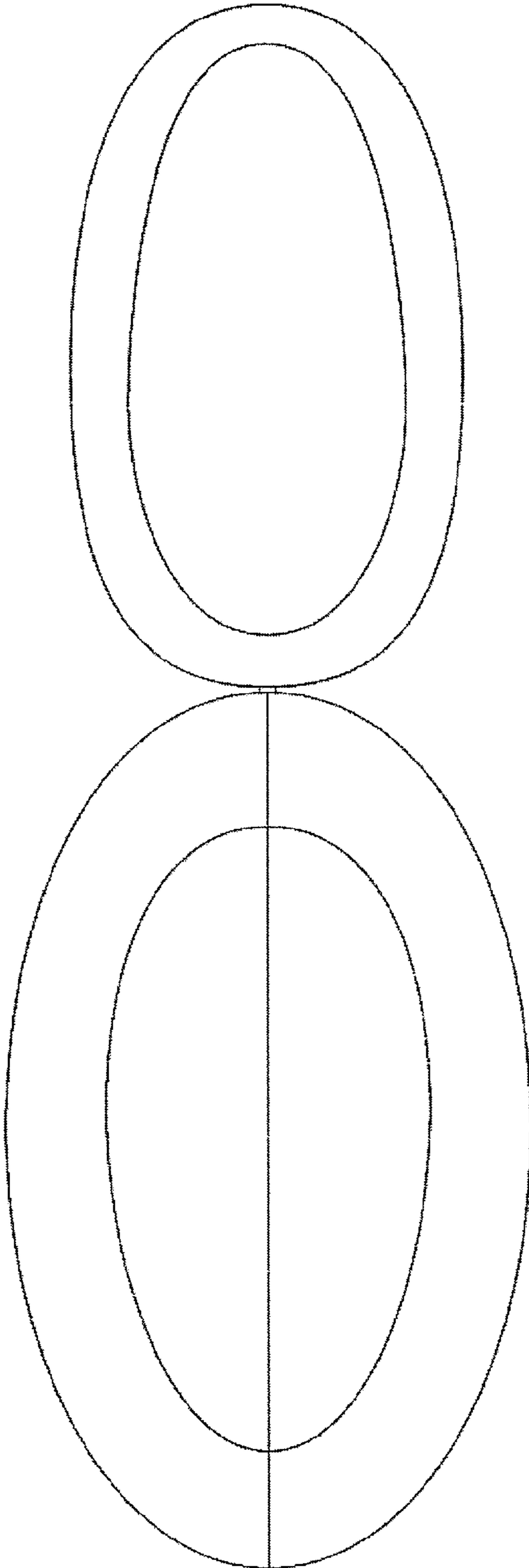

FIG. 3

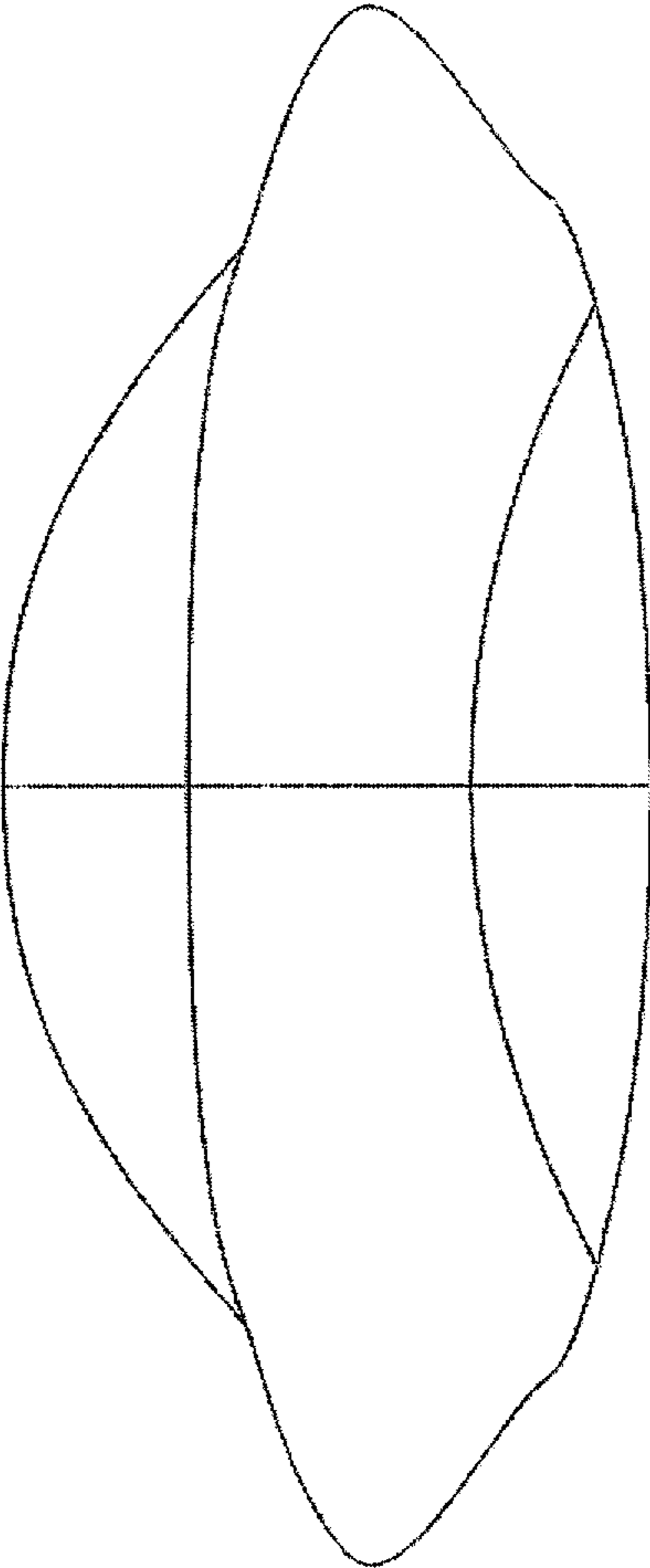

FIG. 4

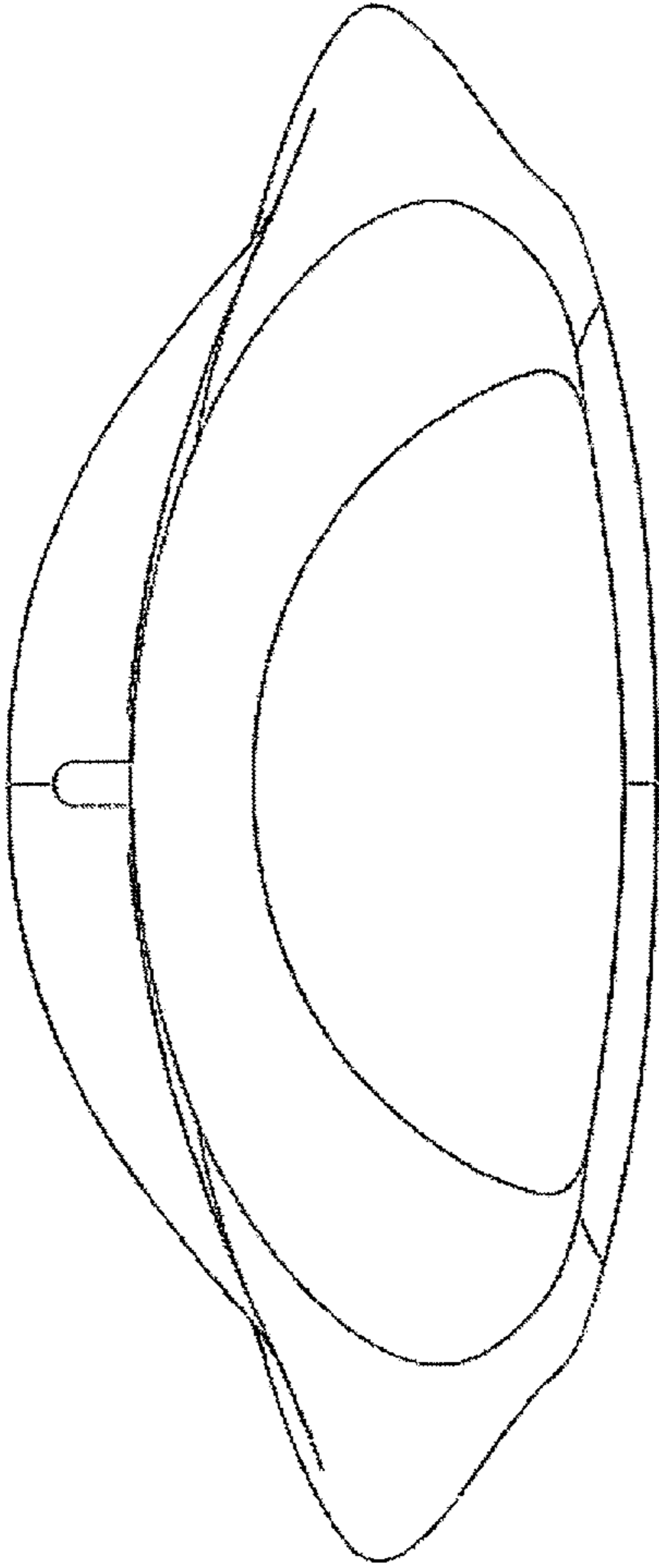

FIG. 5

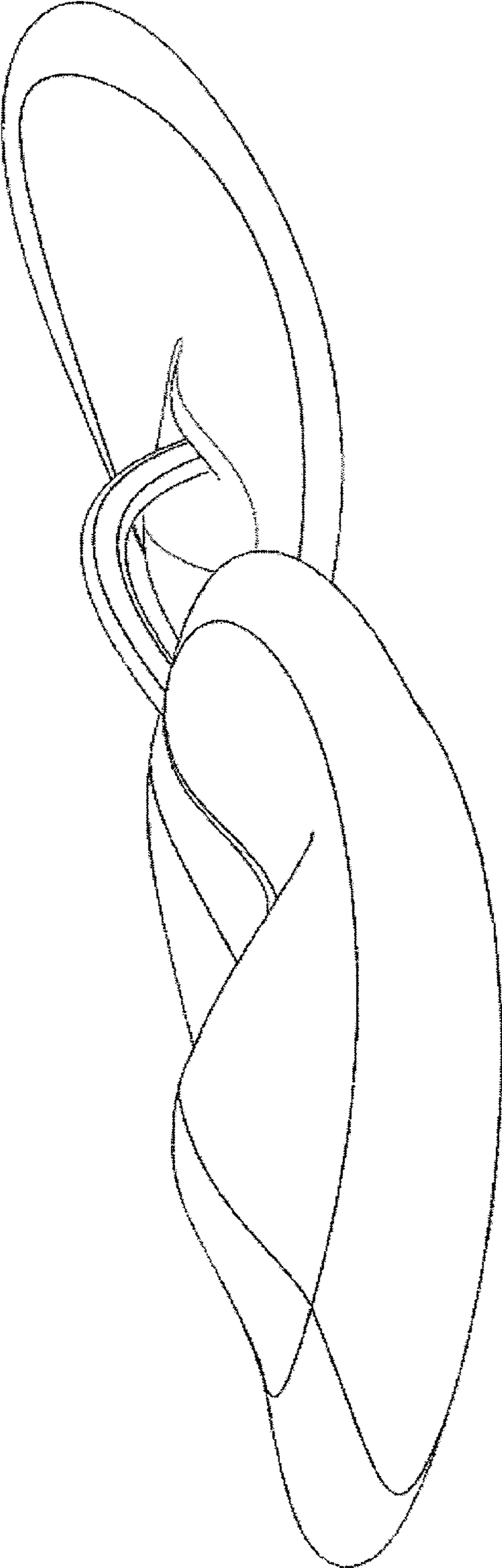

FIG. 6

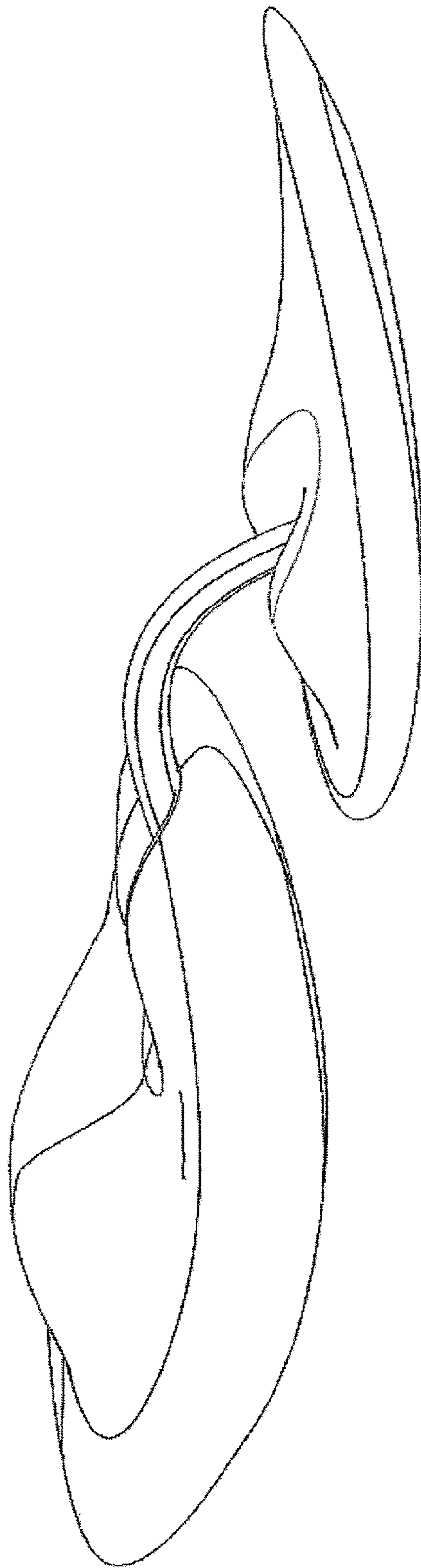

FIG. 7

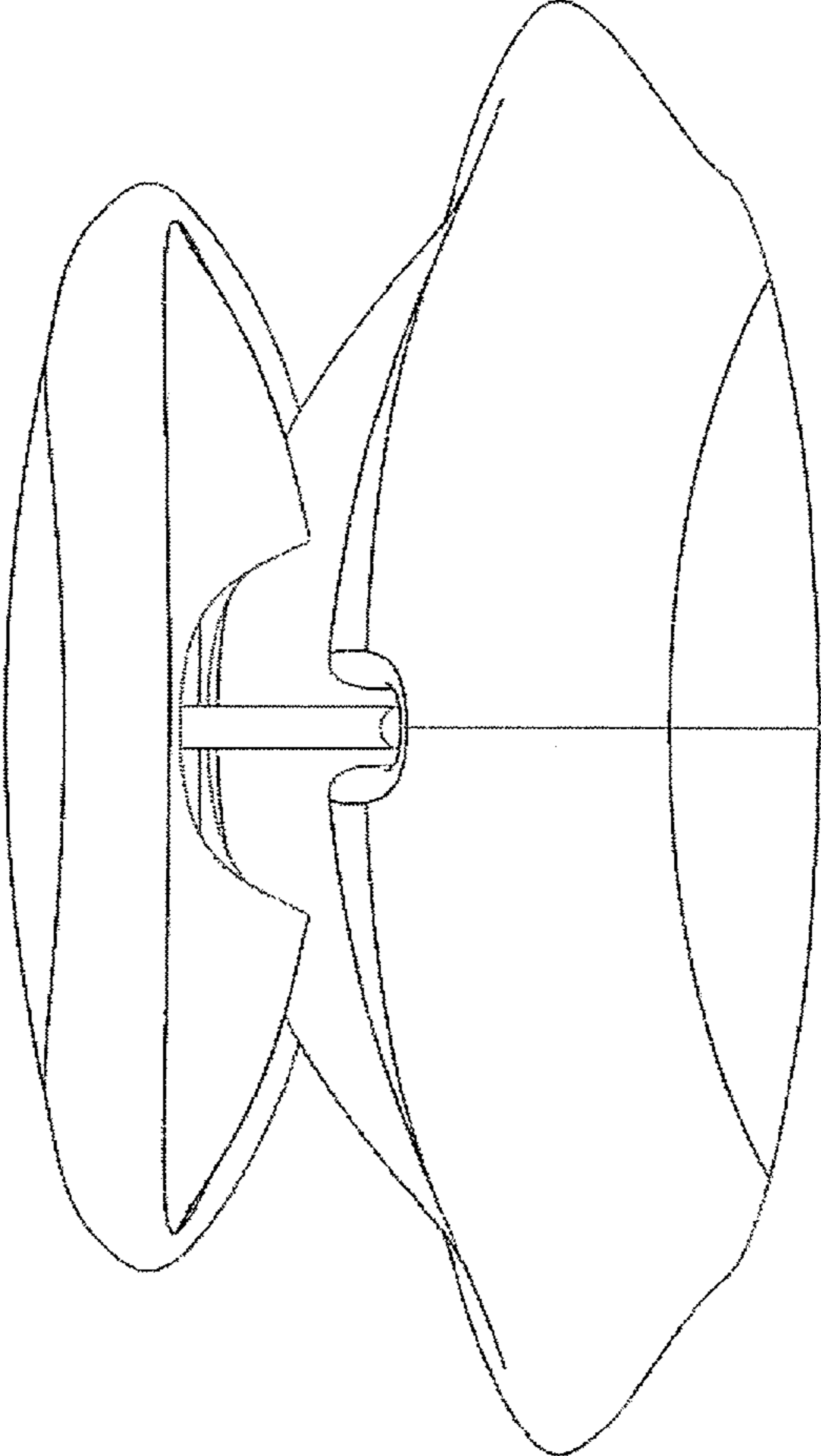

FIG. 8

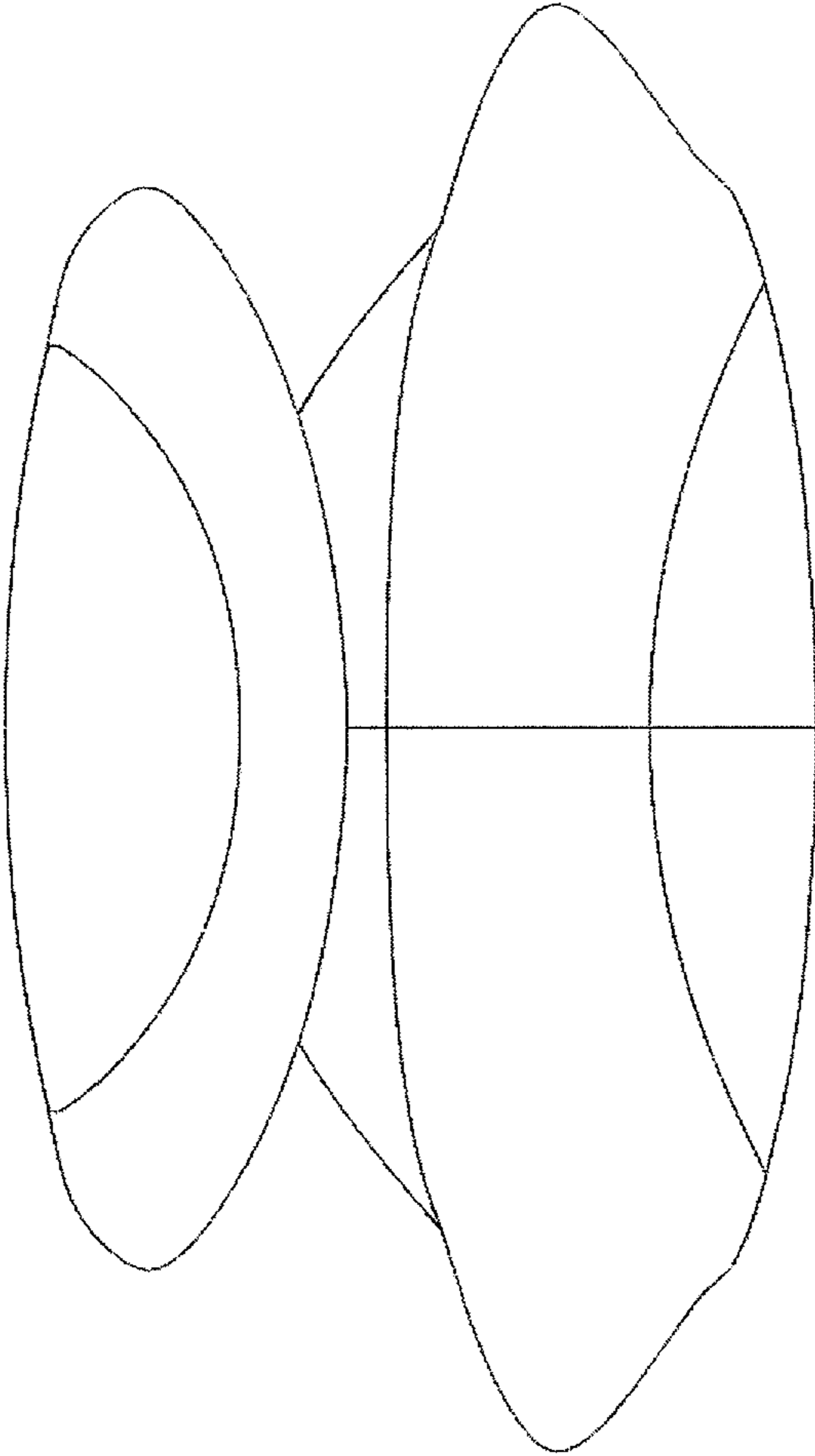

FIG. 9

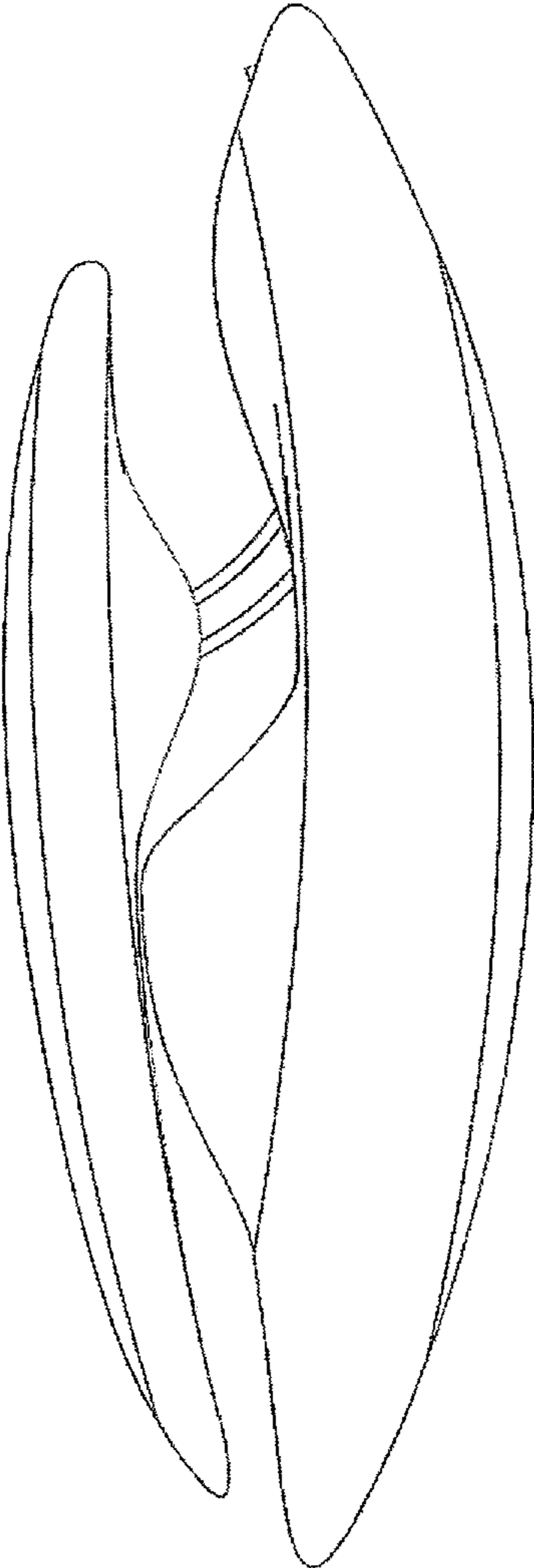

FIG. 10

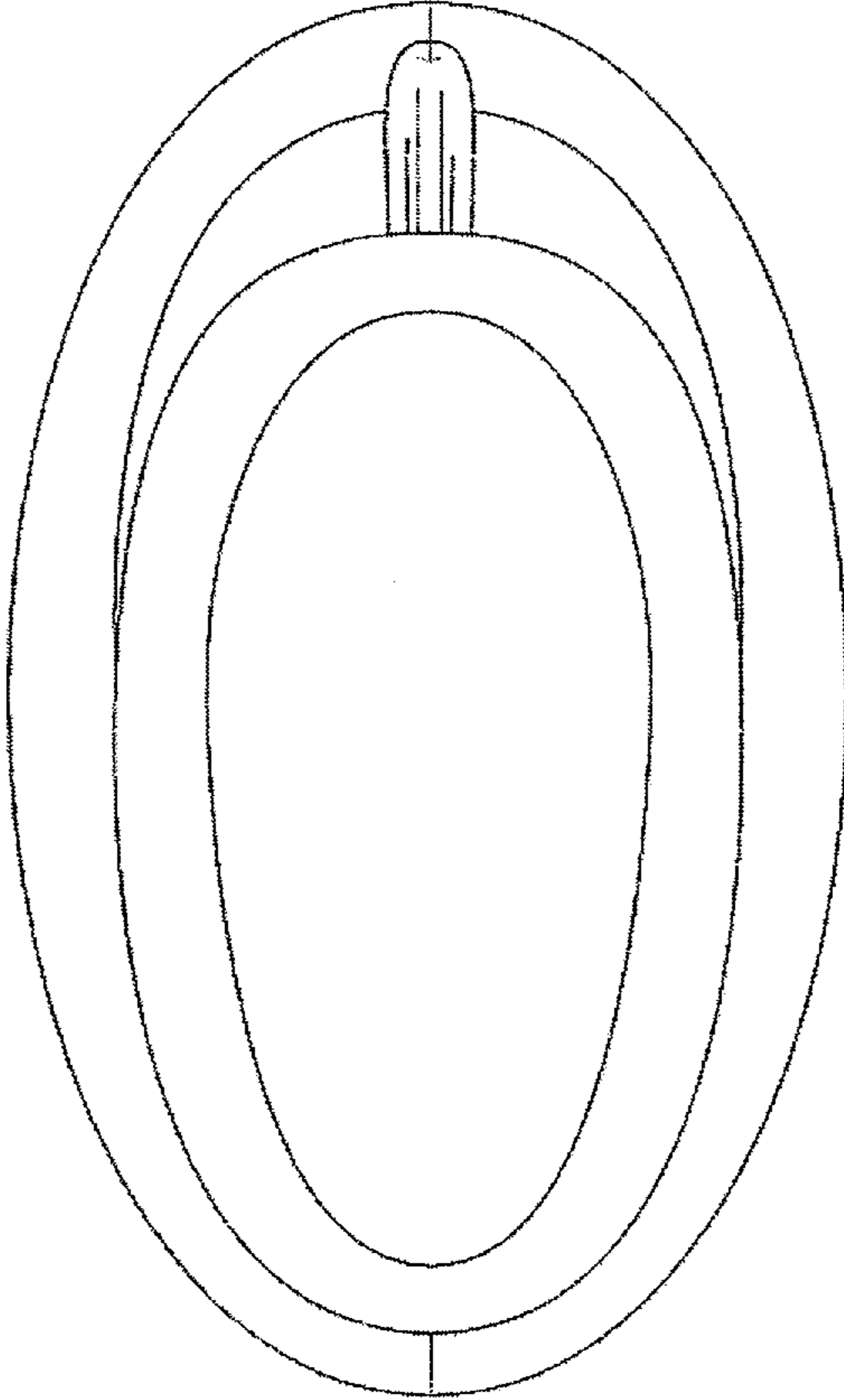

FIG. 11

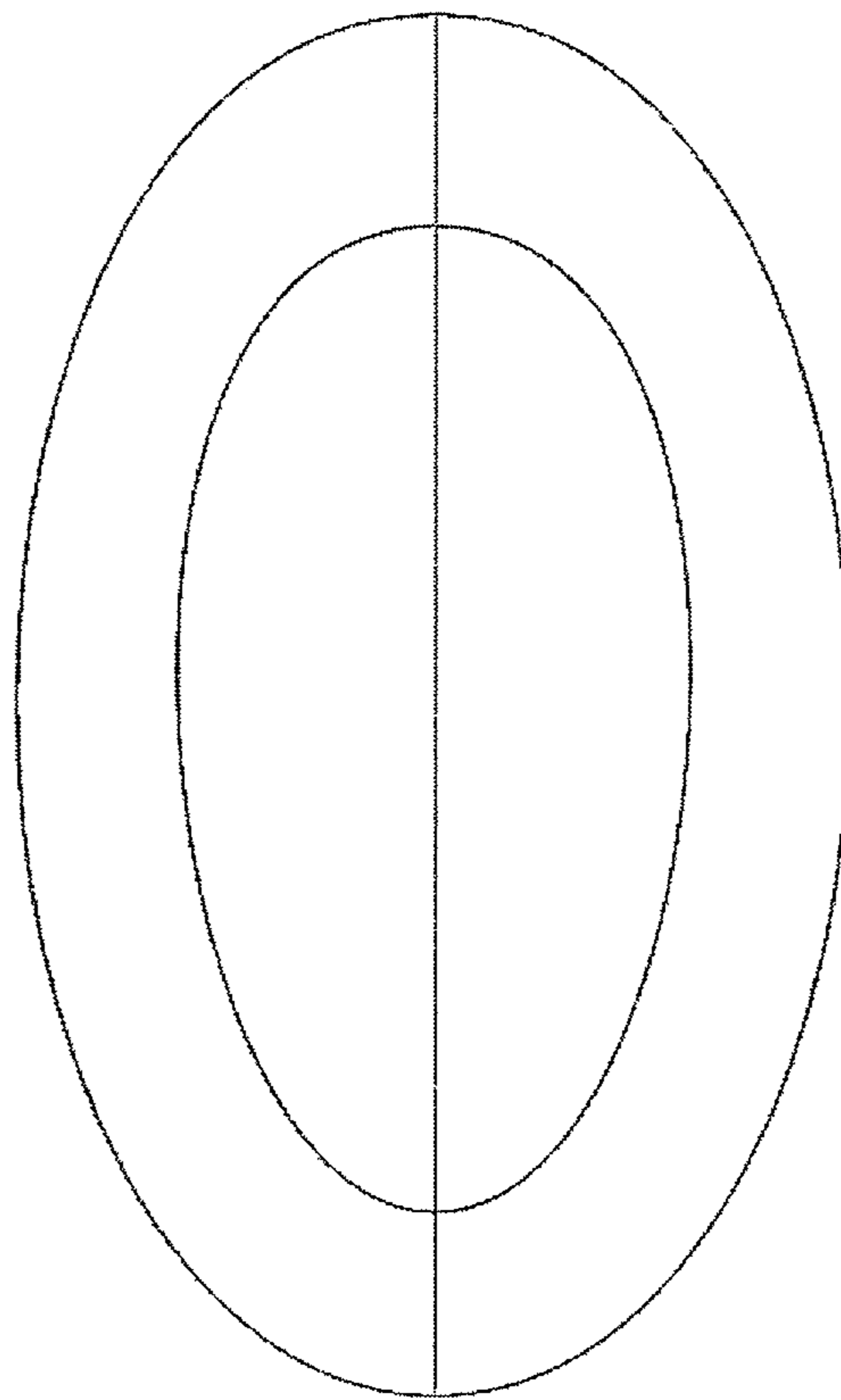

FIG. 12

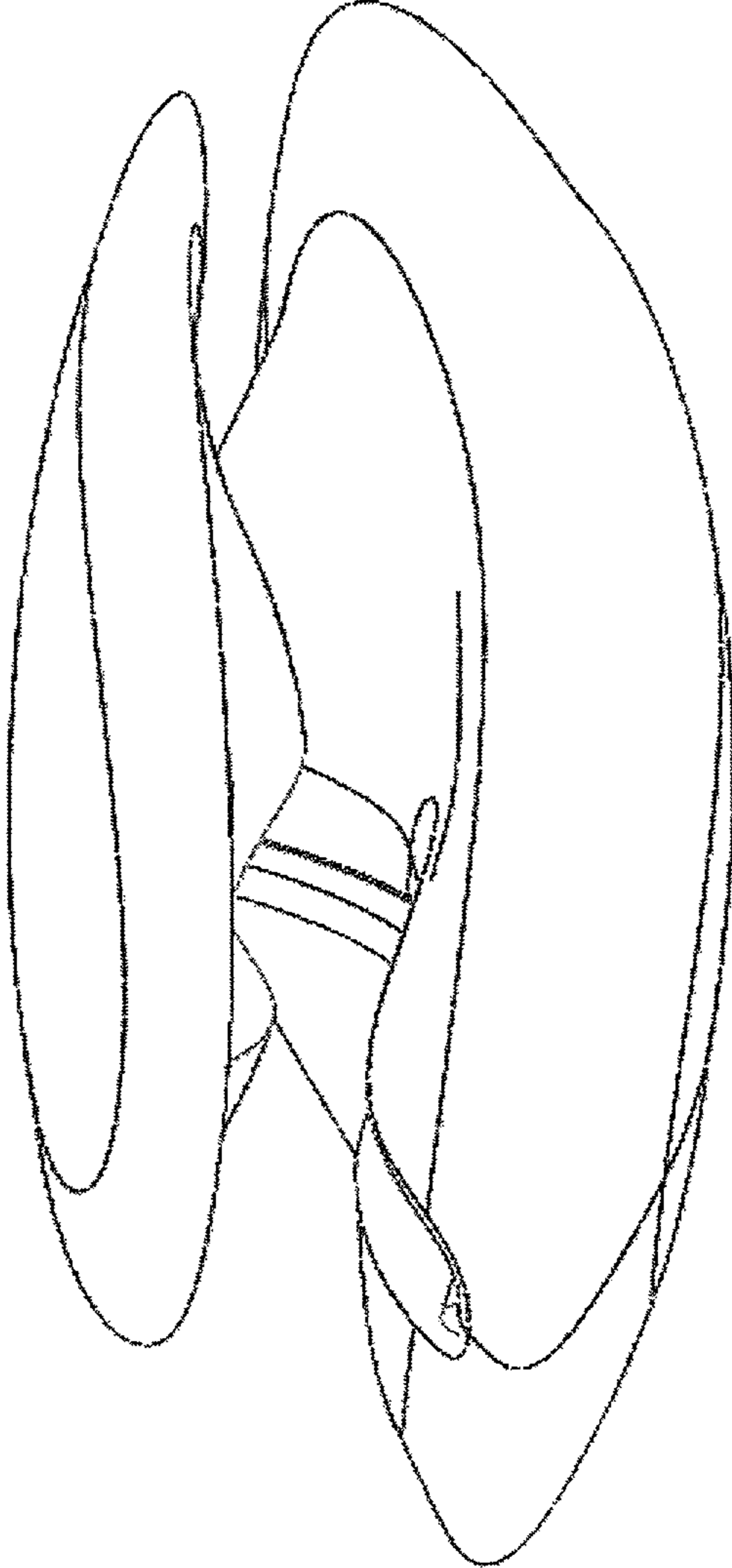

FIG. 13

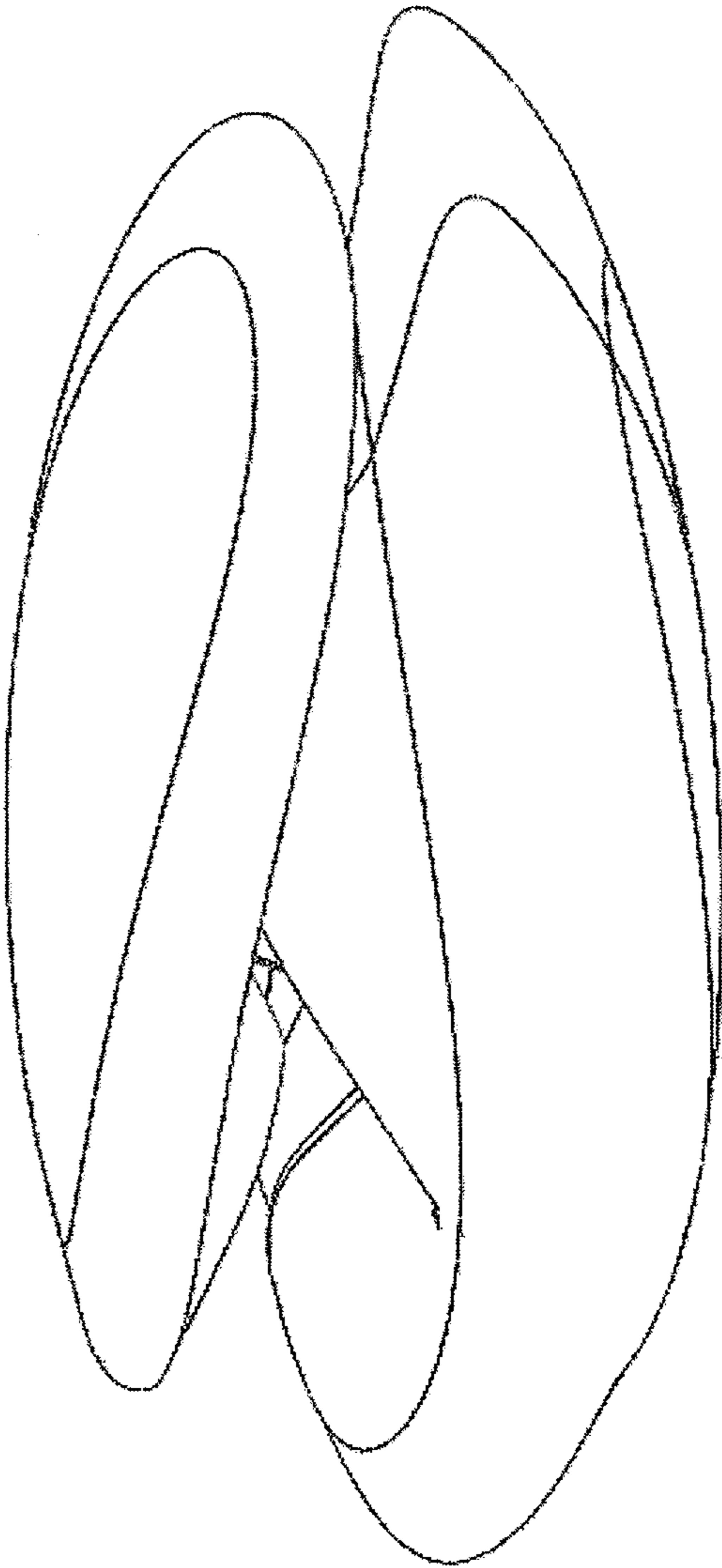

FIG. 14