



US00D698689S

(12) **United States Design Patent**
Boyd

(10) **Patent No.:** **US D698,689 S**

(45) **Date of Patent:** **** Feb. 4, 2014**

(54) **WATCH AND ACCESSORY BAND**

(76) **Inventor:** **Patrick D. Boyd, Aloha, OR (US)**

(**) **Term:** **14 Years**

(21) **Appl. No.:** **29/404,277**

(22) **Filed:** **Oct. 18, 2011**

(51) **LOC (10) Cl.** **11-01**

(52) **U.S. Cl.**
USPC **D11/4**

(58) **Field of Classification Search**
USPC D11/1-25; 63/1.11, 3.1, 3.2, 15,
63/15.1-15.4, 15.45, 15.5, 15.6, 15.65;
D28/41; D10/32, 124; 368/284, 276,
368/281, 282

See application file for complete search history.

(56) **References Cited**

U.S. PATENT DOCUMENTS

D89,450 S *	3/1933	Reiss	D11/4
4,060,185 A *	11/1977	Kuroda	224/176
4,093,973 A *	6/1978	Vaagenes	362/104
D250,634 S *	12/1978	Porsche	D10/32
4,473,304 A *	9/1984	Ketner	368/281
4,664,533 A *	5/1987	Wollman	368/282
4,958,279 A *	9/1990	Proellochs	368/282
D510,037 S *	9/2005	Modolo	D10/32
D511,978 S *	11/2005	Wilson	D10/32
D512,921 S *	12/2005	Wilson	D10/32
D513,997 S *	1/2006	Wilson	D10/32
D525,553 S *	7/2006	Toupet	D11/5
7,070,322 B1 *	7/2006	Field et al.	368/281
D566,580 S *	4/2008	Giorgio	D10/32
D584,169 S *	1/2009	Rabati	D10/32
D593,430 S *	6/2009	Komenaka	D11/26
D612,269 S *	3/2010	Leung	D10/32

D632,604 S *	2/2011	Hanson	D11/3
D640,948 S *	7/2011	Quigley	D11/3
D643,322 S *	8/2011	Tuttle	D11/4
D645,360 S *	9/2011	Kiser et al.	D10/32
D657,705 S *	4/2012	Guerrero, II	D11/4
D687,736 S *	8/2013	Wycoff	D11/3
D688,968 S *	9/2013	Guerrero, II	D11/3
2012/0087216 A1 *	4/2012	Keung et al.	368/282
2012/0234043 A1 *	9/2012	Guerrero, II	63/13

* cited by examiner

Primary Examiner — Cathron Brooks

Assistant Examiner — Melanie Pellegrini

(57) **CLAIM**

The ornamental design for a watch and accessory band, as shown and described.

DESCRIPTION

FIG. 1 is an isometric view of a watch and accessory band, according to the invented design.

FIG. 2 is a front elevation view of the watch and accessory band corresponding to FIG. 1, the back elevation view being a mirror image thereof.

FIG. 3 is a side elevation view of the watch and accessory band corresponding to FIG. 1, the opposing side elevation view being a mirror image thereof.

FIG. 4 is a top view of the watch and accessory band of FIG. 1.

FIG. 5 is a bottom view of the watch and accessory band of FIG. 1; and,

FIG. 6 is an isometric view of the watch and accessory band corresponding to FIG. 1, as during use.

The broken lines shown in FIG. 6 represent unclaimed portions of the watch and accessory band and environmental matter and form no part of the claimed design.

1 Claim, 3 Drawing Sheets

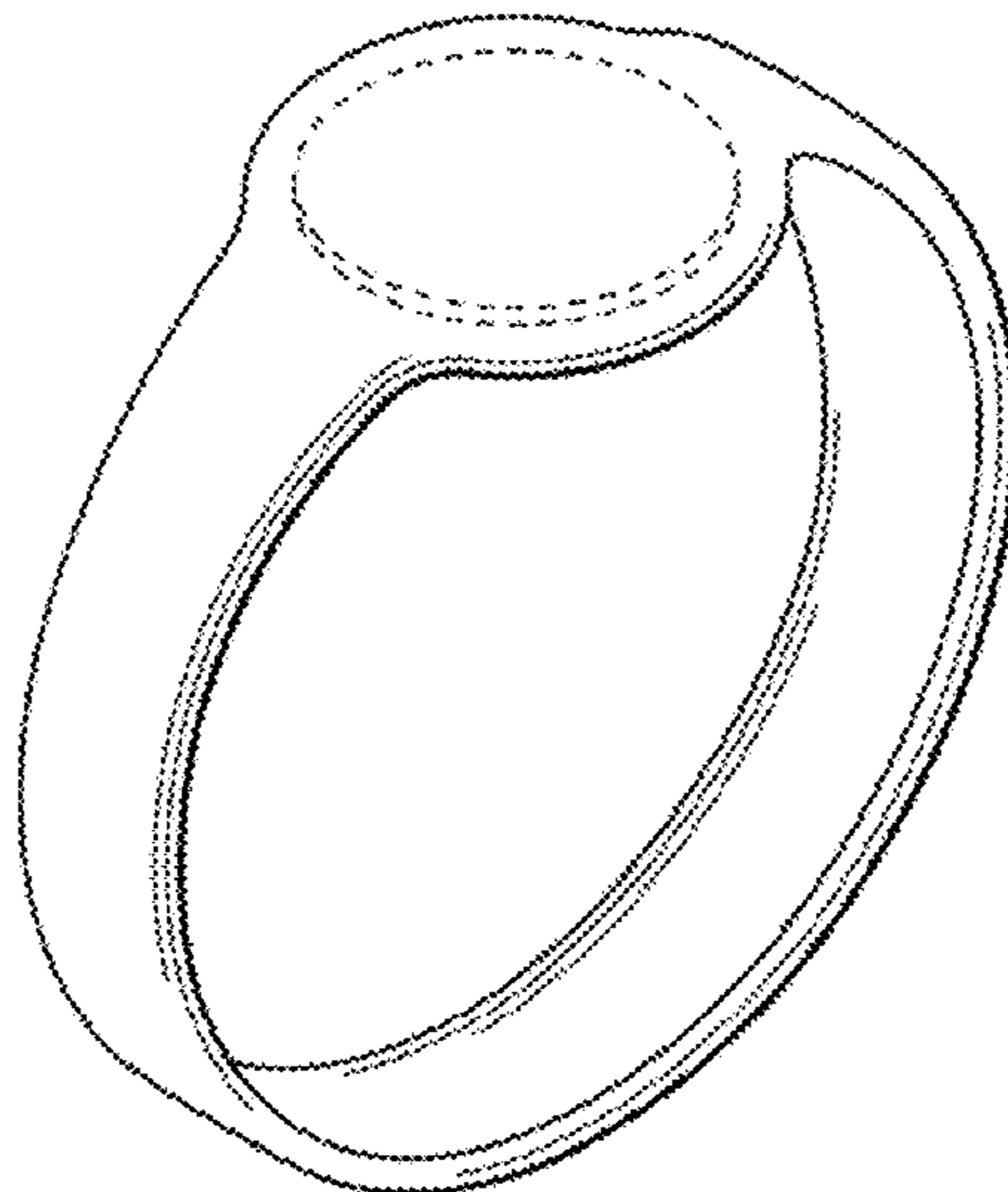

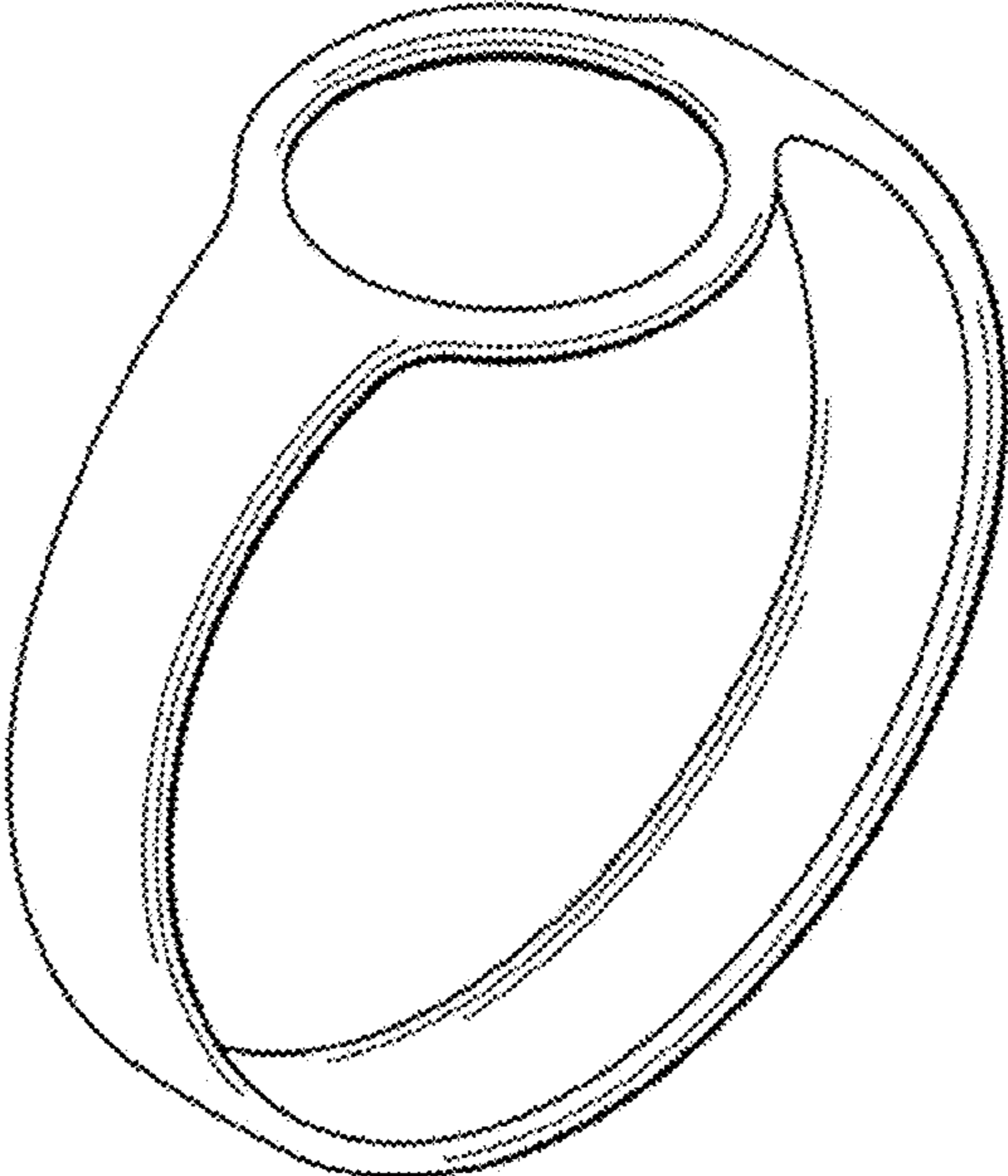

Figure 1

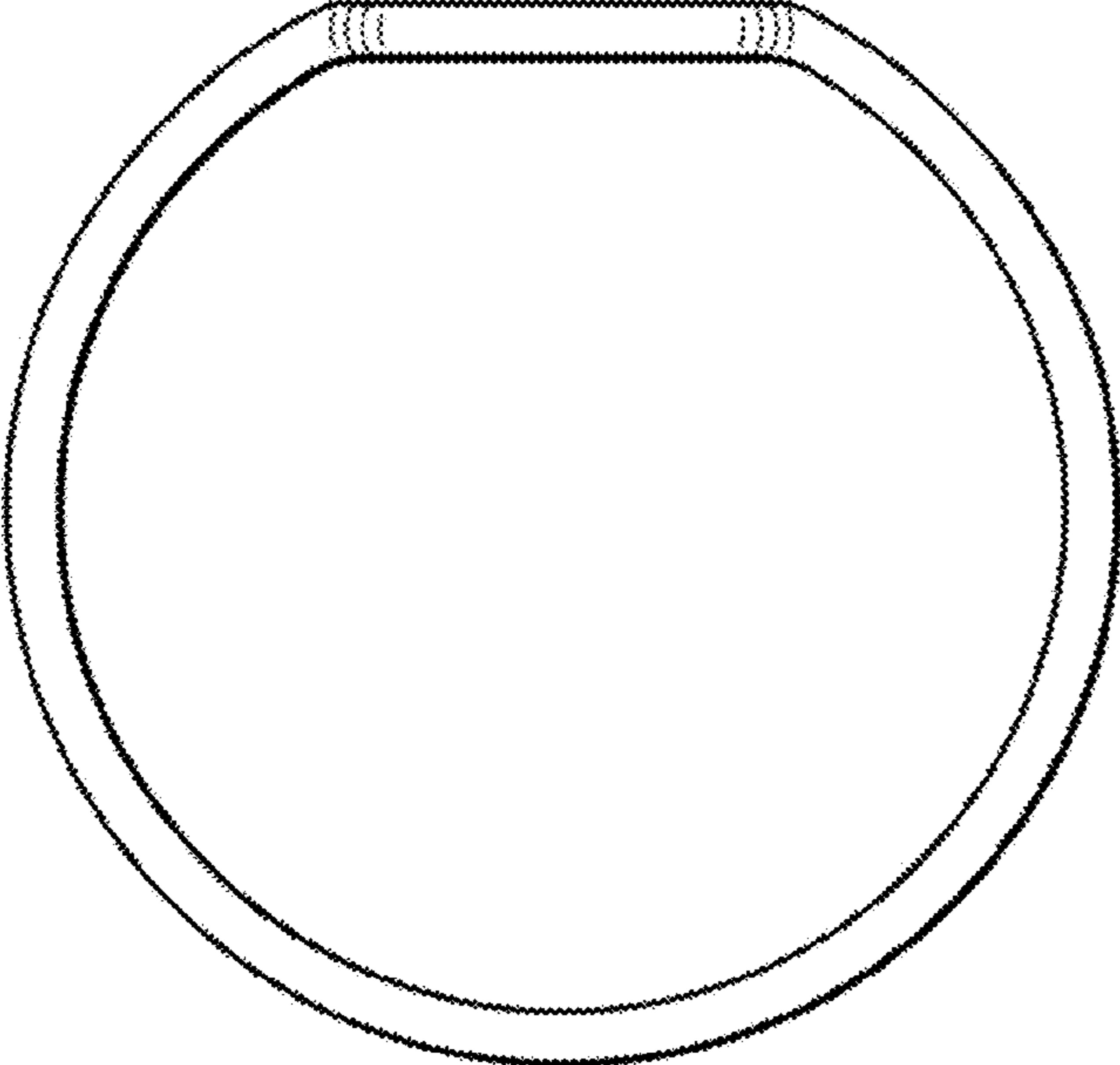

Figure 2

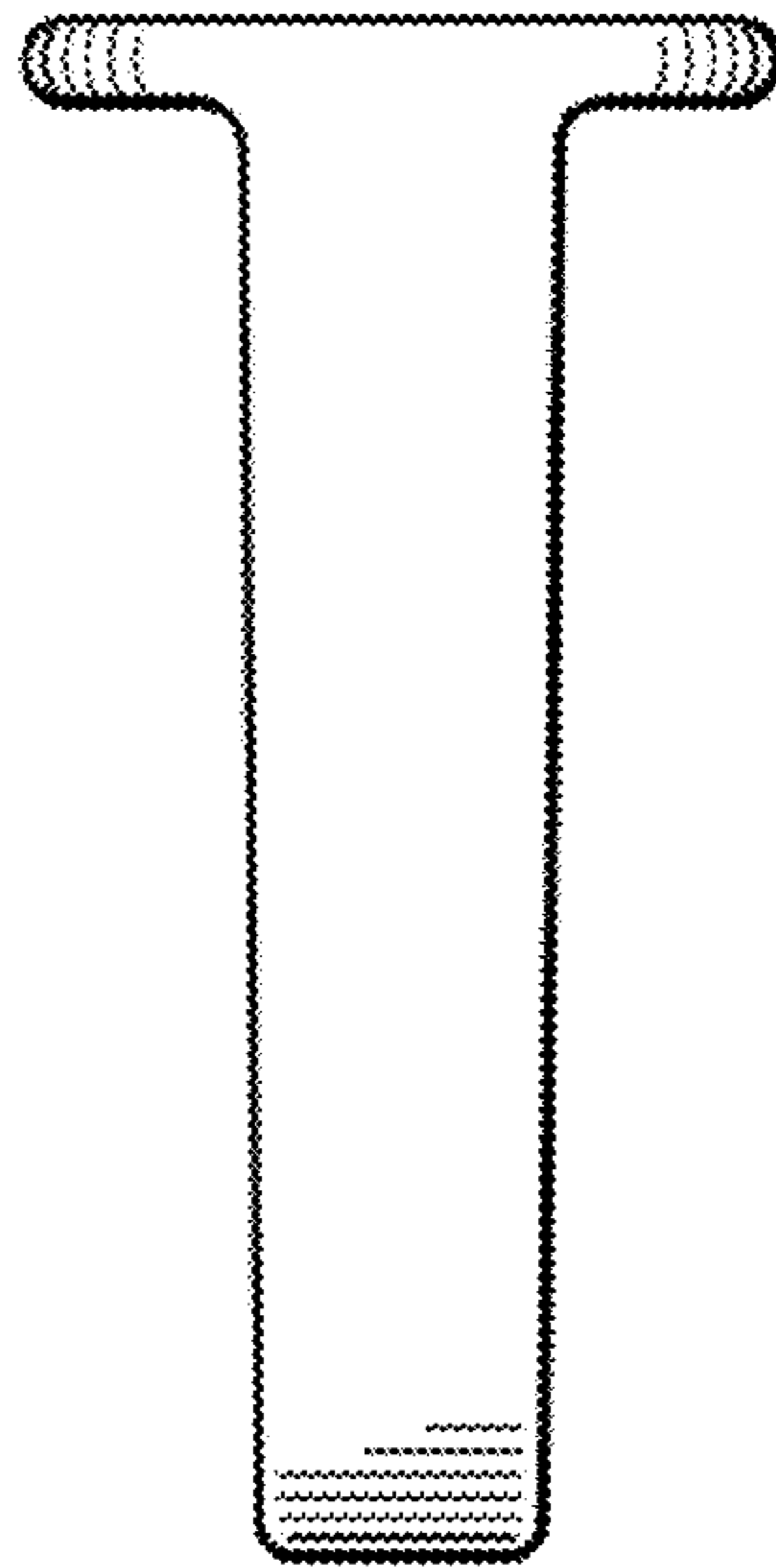

Figure 3

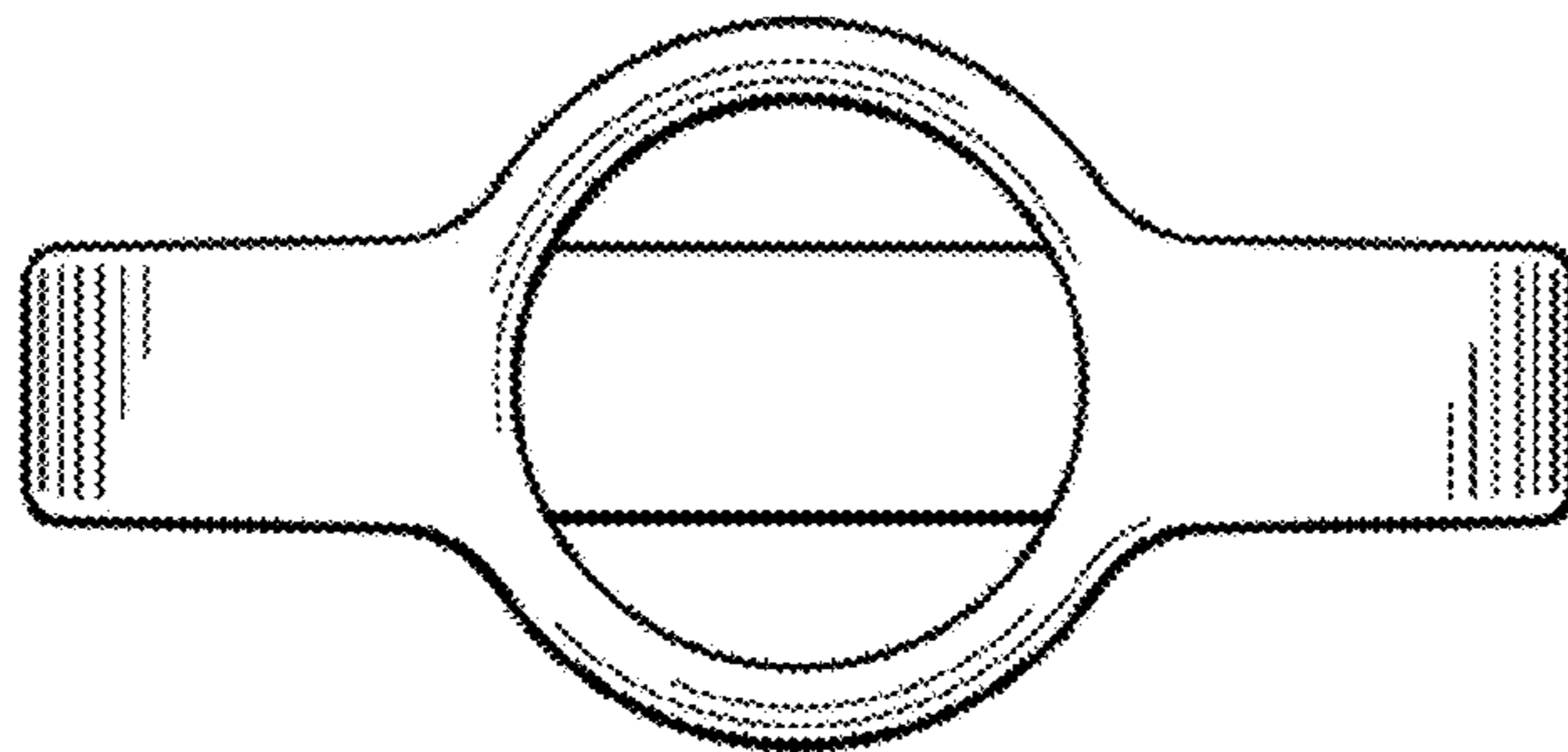

Figure 4

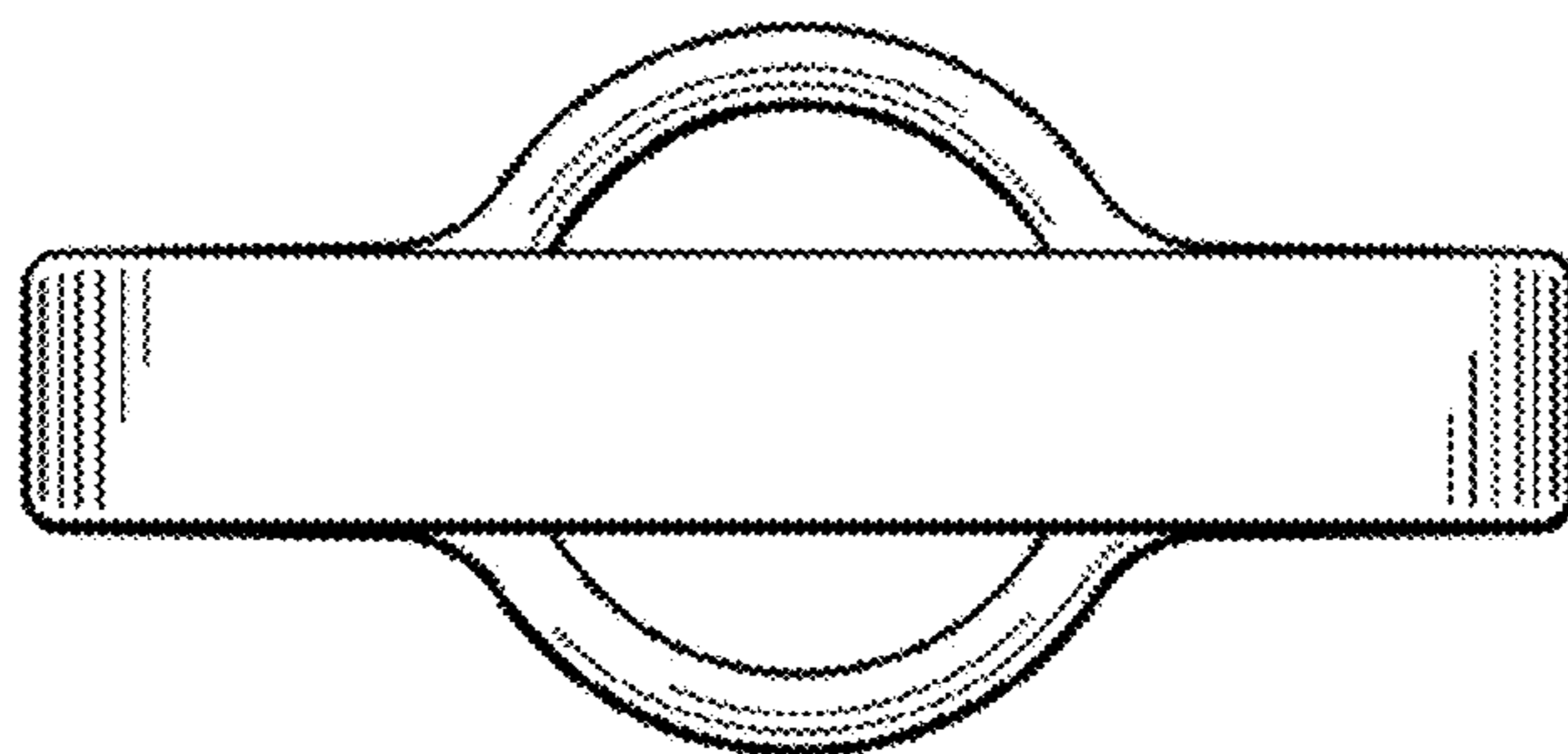

Figure 5

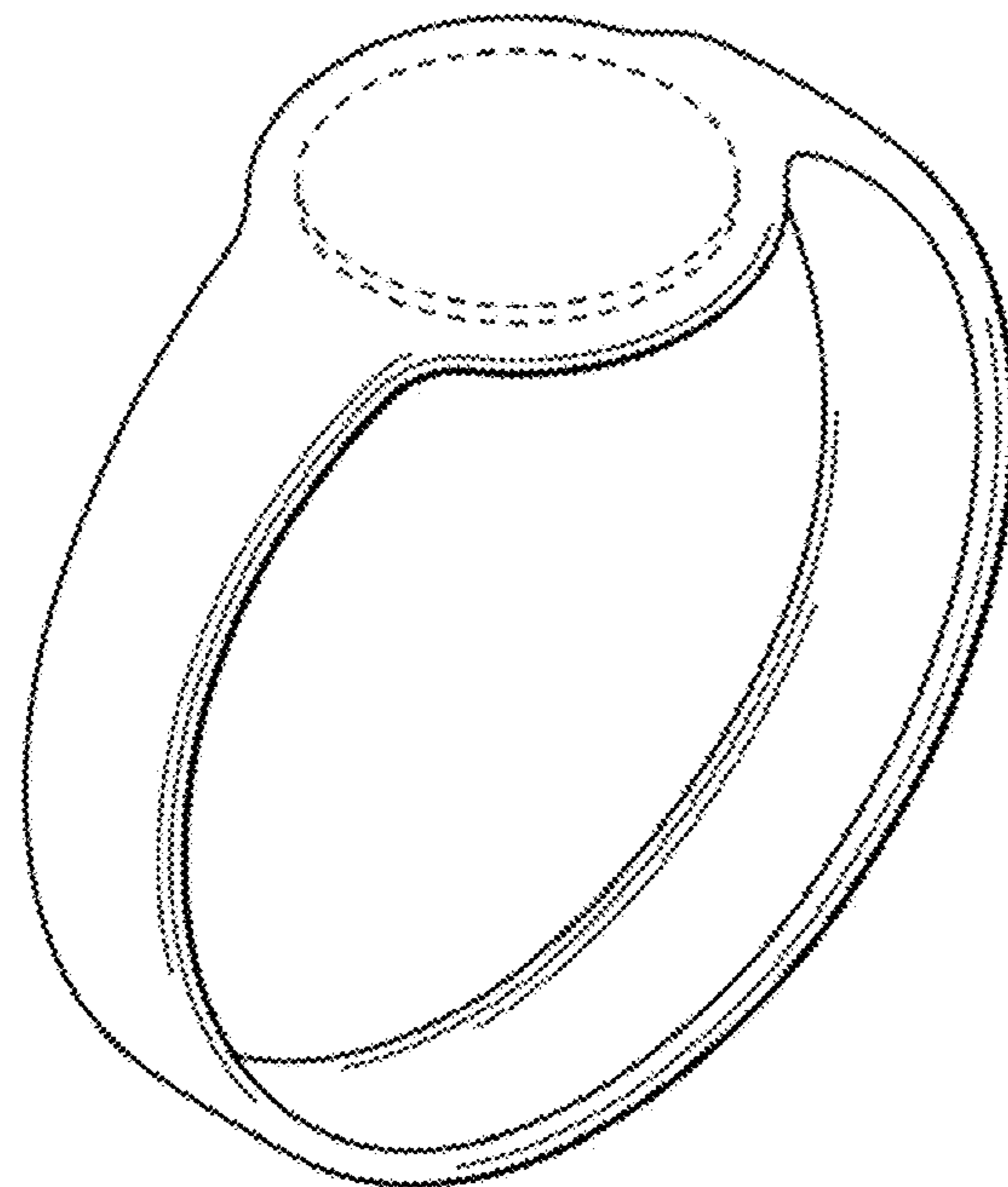

Figure 6